

Office Doctor Discount Office Furniture

www.OfficeDr.com 856-368-9085

Safco Sale On Now

Take 50% Off the List Prices in this PDF

Call 856-368-9085 Now

Free Layout & Design Service

Arc Rotary Files



The ARC™ Rotary File is a double faced unit that rotates easily to provide access to both sides. Using our flexible cantilever style shelving, the ARC provides the most unobstructed filing inches per level and the easiest installation possible. The Complete Starter includes everything needed to house a filing system including the specified number of shelves and dividers. See page 7 Corporate Color Program, paint colors and laminates or go to Safco website to view color swatches.

- Allow 5/4" (letter depth) or 6 1/2" (legal depth) clearance from wall for rotating carriage
- Empty units can be configured in endless variations for mixed media storage solutions
- Alley clearance needed 36"
- Shelves adjust on 1/2"H increments; 120 lb. weight capacity per shelf
- Complete Units are ideal for storing color-coded filing
- To order a fully assembled unit, add the letter "B" after the letter "C" in the part number (e.g. ARCB24403S)
- ARC top is unfinished. Work surfaces are available
- Complete units have slotted shelves with two (2) file dividers per 24" wide shelf; three (3) file dividers per 30" wide shelf
- S: Starter, A: Adder
- Standard Lock on all cabinets comes keyed alike
- Adder units attach to either right or left side of starter unit

PRECONFIGURED IDEA STARTERS

	Parent #	W	D	H	Wt.	Knockdown List Price	Assembled Model No.	Assembled List Price "B"
	6-Tier Complete Letter (288 LFI)							
	ARC24726S	37 1/4"	26 1/4"	73"	403	6,170.00	ARCB24726S	7,035.00
	ARC24726A	31 3/4"	26 1/4"	73"	347	5,658.00	ARCB24726A	6,522.00
	Legal (360 LFI)							
	ARC30726S	46"	32 1/4"	73"	542	7,798.00	ARCB30726S	8,671.00
	ARC30726A	39 1/4"	32 1/4"	73"	478	7,185.00	ARCB30726A	8,069.00
	7-Tier Complete Letter (336 LFI)							
	ARC24827S	37 1/4"	26 1/4"	83 1/2"	427	6,988.00	ARCB24827S	7,867.00
	ARC24827A	31 3/4"	26 1/4"	83 1/2"	365	6,421.00	ARCB24827A	7,294.00
	Legal (420 LFI)							
	ARC30827S	46"	32 1/4"	83 1/2"	588	8,666.00	ARCB30827S	9,529.00
	ARC30827A	39 1/4"	32 1/4"	83 1/2"	516	7,817.00	ARCB30827A	8,842.00
	8-Tier Complete Letter (384 LFI)							
	ARC24938S	37 1/4"	26 1/4"	94"	478	7,841.00	N/A	N/A
	ARC24938A	31 3/4"	26 1/4"	94"	408	7,226.00	N/A	N/A
	Legal (480 LFI)							
	ARC30938S	46"	32 1/4"	94"	632	9,566.00	N/A	N/A
	ARC30938A	39 1/4"	32 1/4"	94"	550	8,898.00	N/A	N/A

ARC™ ROTARY FILE - EMPTY CABINET

See page 7 for Safco Corporate Color Program, Laminates and Paint colors or go to Safco website to view color swatches. Contact your local Safco Sales Rep Group to discuss space planning specific application, obtain prior approval and quote.

	Parent #	W	D	H	Wt.	Knockdown List Price	Assembled Model No.	Assembled List Price "B"
	6-Tier Empty Letter							
	ARC24726ES	37 1/4"	26 1/4"	73"	303	4,803.00	ARCB24726ES	5,649.00
	ARC24726EA	31 3/4"	26 1/4"	73"	247	4,307.00	ARCB24726EA	5,260.00
	Legal							
	ARC30726ES	46"	32 1/4"	73"	399	5,923.00	ARCB30726ES	6,913.00
	ARC30726EA	39 1/4"	32 1/4"	73"	335	5,435.00	ARCB30726EA	6,310.00
	7-Tier Empty Letter							
	ARC24827ES	37 1/4"	26 1/4"	83 1/2"	323	5,492.00	ARCB24827ES	6,183.00
	ARC24827EA	31 3/4"	26 1/4"	83 1/2"	261	4,927.00	ARCB24827EA	5,631.00
	Legal							
	ARC30827ES	46"	32 1/4"	83 1/2"	423	6,631.00	ARCB30827ES	7,419.00
	ARC30827EA	39 1/4"	32 1/4"	83 1/2"	351	5,975.00	ARCB30827EA	6,768.00
	8-Tier Empty Letter							
	ARC24938ES	37 1/4"	26 1/4"	94"	345	6,116.00	N/A	N/A
	ARC24938EA	31 3/4"	26 1/4"	94"	275	5,519.00	N/A	N/A
	Legal							
	ARC30938ES	46"	32 1/4"	94"	437	7,434.00	N/A	N/A
	ARC30938EA	39 1/4"	32 1/4"	94"	355	6,636.00	N/A	N/A

• Not available assembled

Contact your local Safco Sales Rep Group to discuss space planning specific application, obtain prior approval and quote.

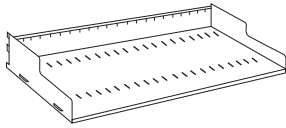

Parent #	W	H	D	Wt.	List Price
Slotted Shelves (SLF)					
ARC2412SLF	24"	6"	12"	8	124.00
ARC3015SLF	30"	6"	15"	12	151.00

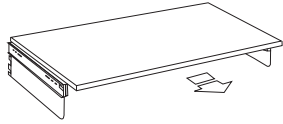

Parent #	W	H	D	Wt.	List Price
Pull Out Reference Shelves (RS)					
ARC2412RS	24"	—	12"	20	518.00
ARC3015RS	30"	—	15"	23	543.00

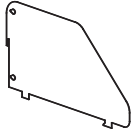

Parent #	W	H	D	Wt.	List Price
Adjustable File Dividers(DV) – Standard Pack of 6					
F12DV6	—	6"	12"	6	76.00
F15DV6	—	6"	15"	7.5	87.00

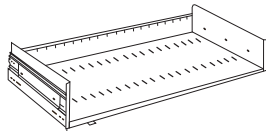

Parent #	W	H	D	Wt.	List Price
Rollout Shelves (ROSLF)					
ARC2412ROSLF	24"	6"	12"	22	518.00
ARC3015ROSLF	30"	6"	15"	25	591.00

Note: When ordering rollout accessories, **Upright Rollout Supports** must be ordered for each side of the ARC™ Rotary File with installed rollout accessories. (See below)

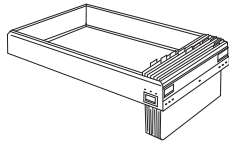

Parent #	W	H	D	Wt.	List Price
Rollout Hanging Frames (ROHF)					
ARC2412ROHF	24"	—	12"	12.5	518.00
ARC3015ROHF	30"	—	15"	13.5	541.00

Note: When ordering rollout accessories, **Upright Rollout Supports** must be ordered for each side of the ARC™ Rotary File with installed rollout accessories. (See below)

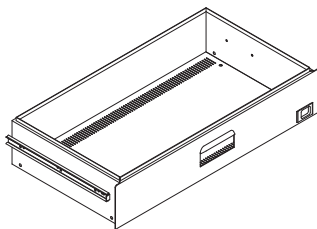

Parent #	H	D	Wt.	List Price
Rollout Drawers (ROD)				
ARC2412ROD105	10½"	12"	32	617.00
ARC3015ROD105	10½"	15"	36	659.00
ARC2412ROD120	12"	12"	37	671.00
ARC3015ROD120	12"	15"	41	719.00

Note: When ordering rollout accessories, **Upright Rollout Supports** must be ordered for each side of the ARC™ Rotary File with installed rollout accessories. (See below)

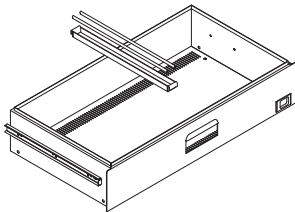

Converter Bar (CB)
 Use with rollout drawers or hanging frame kits
 To file front-to-back, use the following converter bars:

- Sold individually, not in pairs

Parent #	D	Wt.	List Price
ARC12CB	12"	1	113.00
ARC15CB	15"	1	121.00

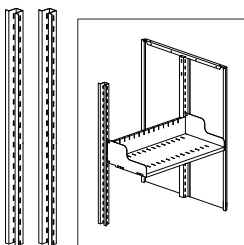

Upright Rollout Supports (sold in pairs)
 Required on each side of ARC™ Rotary File with Rollout Components

Parent #	Description	List Price
URS6	6-Tier Supports	148.00
URS7	7-Tier Supports	148.00
URS8	8-Tier Supports	148.00

Order 2 pair if filling both sides of the cabinet.

Contact your local Safco Sales Rep Group to discuss space planning specific application, obtain prior approval and quote.



Center Panels (CP)

Used as security or privacy panel between front and back sections of cabinet.

Parent #	W	H	Wt.	List Price
ARC2472CP	23"	6-tier	19	300.00
ARC3072CP	29"	6-tier	24	319.00
ARC2482CP	23"	7-tier	22	324.00
ARC3082CP	29"	7-tier	28	349.00
ARC2493CP	23"	8-tier	25	376.00
ARC3093CP	29"	8-tier	32	406.00

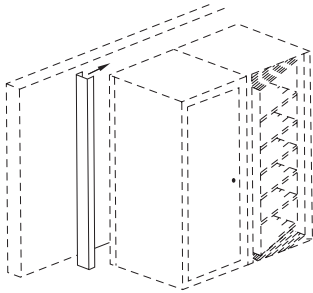

Wall Closure Strips (WCS)

Closes space between ARC™ unit and wall. Letter: 5 1/4", Legal: 6 1/2".

Parent #	Size	H	Wt.	List Price
ARC2472WCS	LTR	6-tier	18	168.00
ARC3072WCS	LGL	6-tier	20	168.00
ARC2482WCS	LTR	7-tier	23	203.00
ARC3082WCS	LGL	7-tier	28	199.00
ARC2493WCS	LTR	8-tier	27	234.00
ARC3093WCS	LGL	8-tier	30	234.00

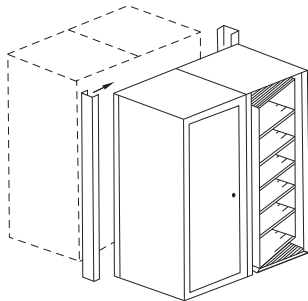

Back-to-Back Closure Strips (BTB)

Used to enclose the space between two ARC™ units when placed back-to-back. Letter: 10 1/2", Legal: 13"

Parent #	Size	H	Wt.	List Price
ARC2472BTB	LTR	6-tier	32	203.00
ARC3072BTB	LGL	6-tier	32	203.00
ARC2482BTB	LTR	7-tier	40	234.00
ARC3082BTB	LGL	7-tier	40	230.00
ARC2493BTB	LTR	8-tier	48	261.00
ARC3093BTB	LGL	8-tier	48	267.00



End Panel Assemblies (EP)

Parent #	Size	H	Wt.	List Price
ARC2472EP	LTR	6-tier	29	818.00
ARC3072EP	LGL	6-tier	33	936.00
ARC2482EP	LTR	7-tier	32	936.00
ARC3082EP	LGL	7-tier	37	949.00
ARC2493EP	LTR	8-tier	36	1,022.00
ARC3093EP	LGL	8-tier	42	1,111.00