

SPACE PLANNING SERVICES

Space Planning Services

Our team of space planning experts provide workspace and storage solution designs that include our entire product offering. Plus, our design renderings showcase how Safco products will fit into your space and bring in color and textures so you can see what your space will look like – making guesswork a thing of the past.

If you have any space planning questions, contact your local Safco Sales Rep Group.

Certified Installers

Our certified installers undergo in-depth training on all of our Filing & Storage System products. To find an installer near you visit www.safcoproducts.com, Customer Care and click on "Find a Certified Installer".

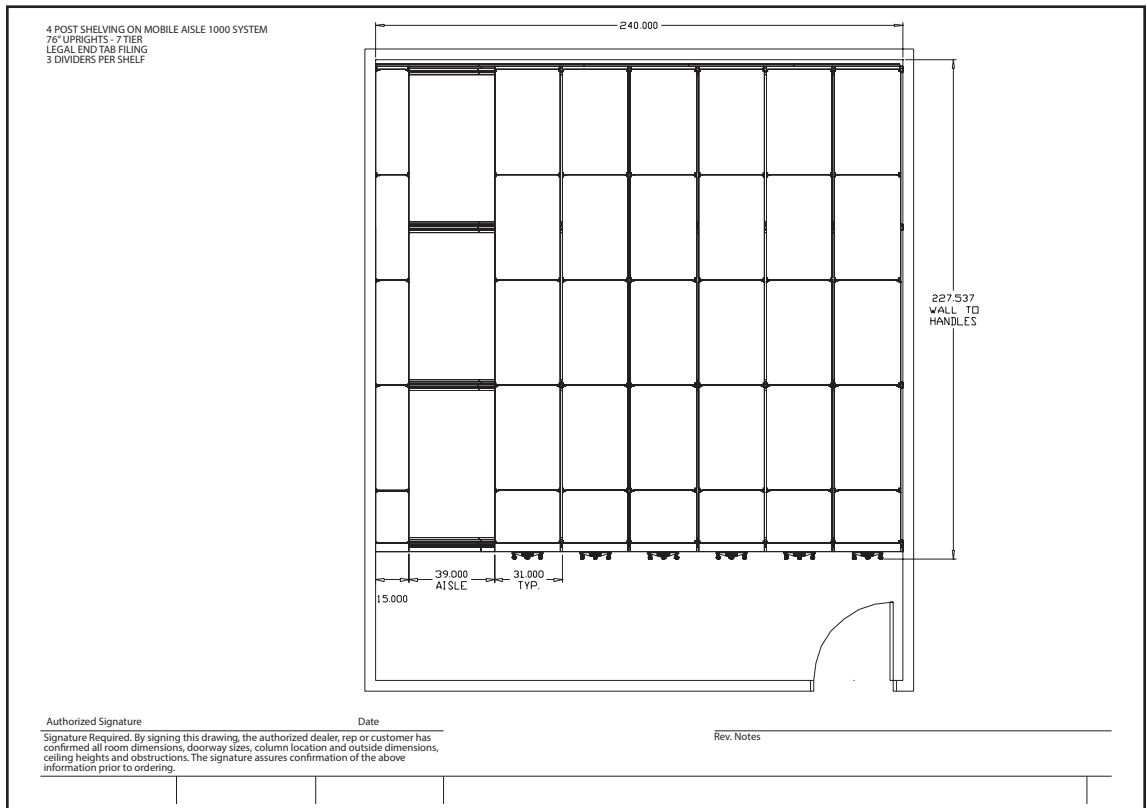
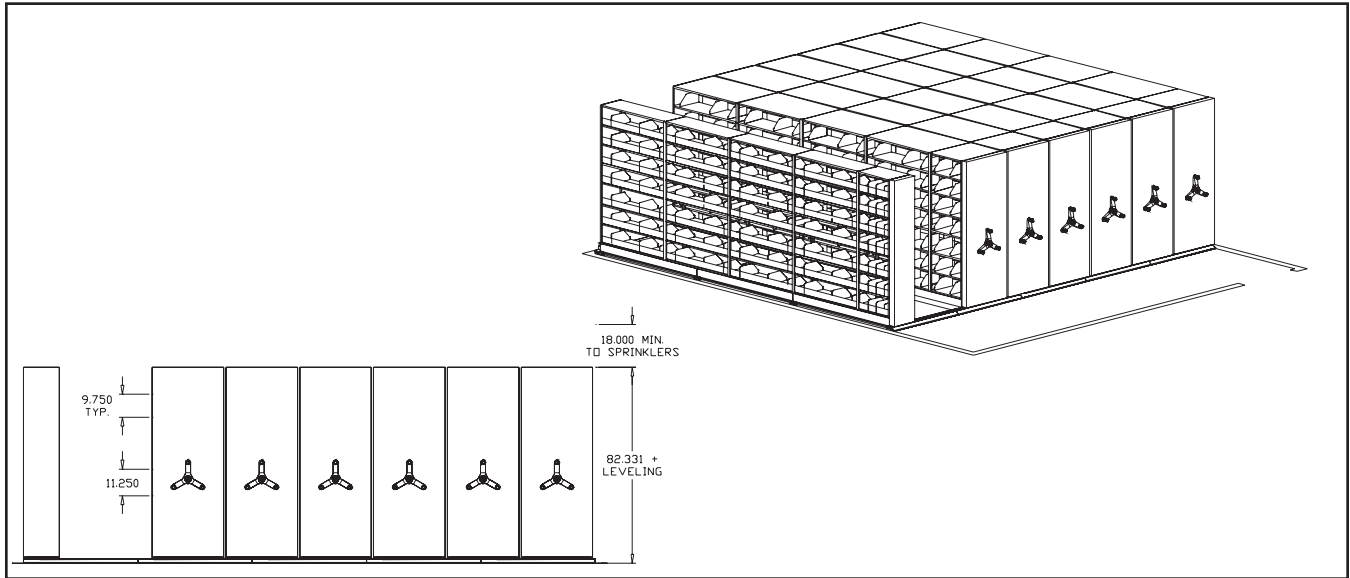

Mobile Aisle 1000™

4-Post Shelving

- Hardware included for Mobile Aisle installation
- End panels provide a finished appearance
- All shelving is offered in 24", 30", 36", 42" and 48" widths
- All shelving is offered in 9", 12", 15", 18", 24", 30 and 36" depths
- Dividers interlock with common stop for stability
- 4-Post design shelving will support 240 lbs. per shelf
- Heavy-Duty will support 800 lbs. per shelf
- Accessories: Roll-out drawers, Posting/Reference Shelf, Slatwall
- Wall anchoring brackets and hardware available

Track, Decking & Ramps

- Non-grouted track, totally re-levelable at any time
- Levelers in pairs positioned every 6"
- Two point contact to floor for weight load distribution
- Track interlocks and overlaps at all track joints
- Attachment to floor with expansion bolt
- Deck is supplied by Safco®
- Available with fire-retardant carpet (Charcoal or Brown Rouse) or unfinished
- Deck panels – complete with levelers
- Low profile standard system entry or ADA/incline ramp options

End Panel Drive Assemblies

- 1 pound of pressure required to move 10,000 lbs.
- All steel, no particleboard
- Painted steel end panels available in standard Safco® Corporate colors, see page 10 or go to Safco website to view color swatches
- Three spoke handle which includes a range safety lock with red locking indicator

If you have any space planning questions, contact your local Safco Sales Rep Group.

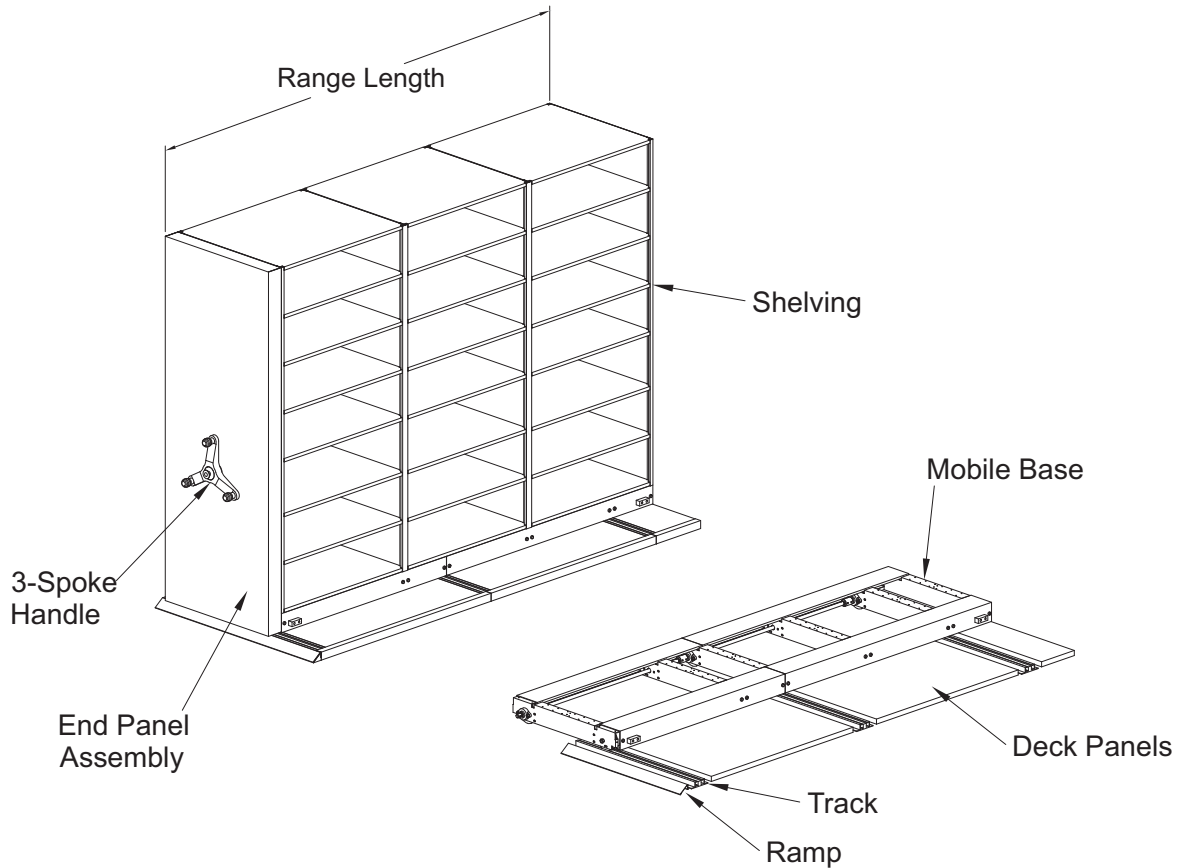

Office Suites
Seating
Tables & Desks
Meeting Essentials
Personal Organization
Ergonomics
High Density Storage
Storage & Filing
Facilities
Technology Furniture
Art & Engineering
K-12 Education
SAFE Collection Addendum

Think of Mobile Lite as the streamlined version of Mobile 1000 – same concept with a few modifications that make it even more affordable and it installs in half the time of larger, heavy-duty systems.

The easy-to-order Mobile Lite typical model numbers include the following: one single faced fixed unit, one single faced movable unit and a range of 2 to 4 double faced movable units. Model numbers also include 7-tier 4-post shelving, back panels for single faced units, dividers, half high end panel assembly, key lock included with single faced movable unit, plunger lock included with all double faced movable units, mobile bases, track and additional track for typical aisle walkway. No decking or ramping required. For special customer requirements and design service, or you have any space planning questions, contact your local Safco Sales Rep Group.

Mobile Lite Typical

- Comes with dividers, 3 per shelf
- Letter-size media - 12" Depth

Letter Depth Shelving Model Numbers	System Width	Overall Range Length	Overall Height	Wt.	Aisle	LFI	System Size	List Price
EML3672L	118"	44"	80 ¹ / ₄ "	1,159	36"	1,454"	10' x 4'	14,447.00
EML3673L	144"	44"	80 ¹ / ₄ "	1,500	36"	1,939"	12' x 4'	17,396.00
EML3674L	170"	44"	80 ¹ / ₄ "	1,844	36"	2,424"	15' x 4'	21,336.00
EML4872L	118"	56"	80 ¹ / ₄ "	1,334	36"	1,958"	10' x 5'	14,875.00
EML4873L	144"	56"	80 ¹ / ₄ "	1,562	36"	2,611"	12' x 5'	19,835.00
EML4874L	170"	56"	80 ¹ / ₄ "	2,099	36"	3,263"	15' x 5'	23,546.00
EML7272L	118"	80"	80 ¹ / ₄ "	1,858	36"	2,912"	10' x 7'	22,087.00
EML7273L	144"	80"	80 ¹ / ₄ "	2,384	36"	3,884"	12' x 7'	28,285.00
EML7274L	170"	80"	80 ¹ / ₄ "	2,909	36"	4,854"	15' x 7'	32,632.00
EML9672L	118"	104"	80 ¹ / ₄ "	2,202	36"	3,916"	10' x 9'	25,213.00
EML9673L	144"	104"	80 ¹ / ₄ "	2,810	36"	5,222"	12' x 9'	30,339.00
EML9674L	170"	104"	80 ¹ / ₄ "	3,417	36"	6,527"	15' x 9'	39,733.00

System Width: Total length from left to right of system

Overall Range Length: From wall to the tip of the handle (dimension includes 1¹/₂" clearance from wall)

Overall Height: Distance from the floor to the top of shelving

Aisle: Walkway between ranges

LFI: The amount of Linear Filing Inches offered in each typical

System Size: Footprint of the system

Letter

EML3672L

EML: Mobile Lite

36: Overall shelving length in inches

7: Number of shelves per unit

2: Number of double face movable units

L: Letter media

Letter

EML4874L

EML: Mobile Lite

48: Overall shelving length in inches

7: Number of shelves per unit

4: Number of double face movable units

L: Letter media

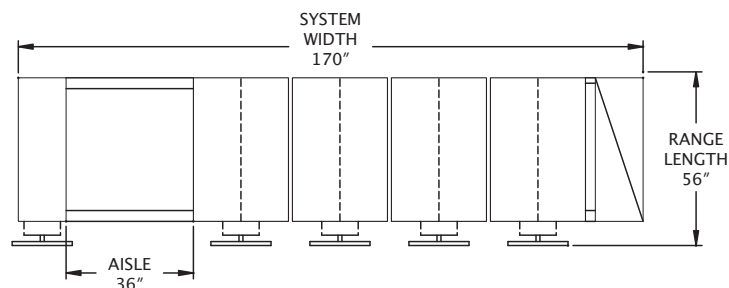
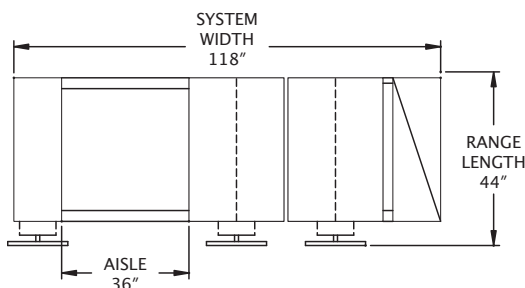

Top View of System Ranges

Mobile Lite Typicals

- Comes with dividers, 3 per shelf
- Legal-size media - 15" Depth

Legal Depth Shelving Model Numbers	System Width	Overall Range Length	Overall Height	Wt.	Aisle	LFI	System Size	List Price
EML3672G	135"	44"	80 ¹ / ₄ "	1,337	36"	1,454"	12' x 4'	14,374.00
EML3673G	167"	44"	80 ¹ / ₄ "	1,745	36"	1,939"	14' x 4'	18,676.00
EML3674G	199"	44"	80 ¹ / ₄ "	2,153	36"	2,424"	17' x 4'	24,408.00
EML4872G	135"	56"	80 ¹ / ₄ "	1,505	36"	1,958"	12' x 5'	15,474.00
EML4873G	167"	56"	80 ¹ / ₄ "	1,955	36"	2,611"	14' x 5'	20,060.00
EML4874G	199"	56"	80 ¹ / ₄ "	2,405	36"	3,263"	17' x 5'	24,541.00
EML7272G	135"	80"	80 ¹ / ₄ "	2,153	36"	2,912"	12' x 7'	23,404.00
EML7273G	167"	80"	80 ¹ / ₄ "	2,770	36"	3,884"	14' x 7'	30,293.00
EML7274G	199"	80"	80 ¹ / ₄ "	3,431	36"	4,854"	17' x 7'	34,695.00

Heavy-Duty - 18" Depth

Depth Shelving Model Numbers	System Width	Overall Range Length	Overall Height	Wt.	Aisle	LFI	System Size	List Price
EML3652X	160"	44"	89"	1,297	42"	1,039"	14' x 4'	18,206.00
EML3653X	198"	44"	89"	1,695	42"	1,385"	17' x 4'	23,542.00
EML3654X	236"	44"	89"	2,097	42"	1,731"	20' x 4'	28,839.00
EML4852X	160"	56"	89"	1,465	42"	1,399"	14' x 5'	18,479.00
EML4853X	198"	56"	89"	1,905	42"	1,865"	17' x 5'	23,867.00
EML4854X	236"	56"	89"	2,365	42"	2,331"	20' x 5'	29,247.00

System Width: Total length from left to right of system

Overall Range Length: From wall to the tip of the handle (dimension includes 1¹/₂" clearance from wall)

Overall Height: Distance from the floor to the top of shelving

Aisle: Walkway between ranges

LFI: The amount of Linear Filing Inches offered in each typical

System Size: Footprint of the system

Legal

EML7273G

EML: Mobile Lite

72: Overall shelving length in inches

7: Number of shelves per unit

3: Number of double face movable units

G: Legal media

Heavy-Duty

EML3652X

EML: Mobile Lite

36: Overall shelving length in inches

5: Number of shelves per unit

2: Number of double face movable units

X: Heavy-duty media

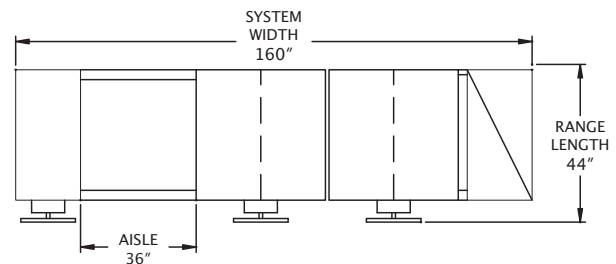
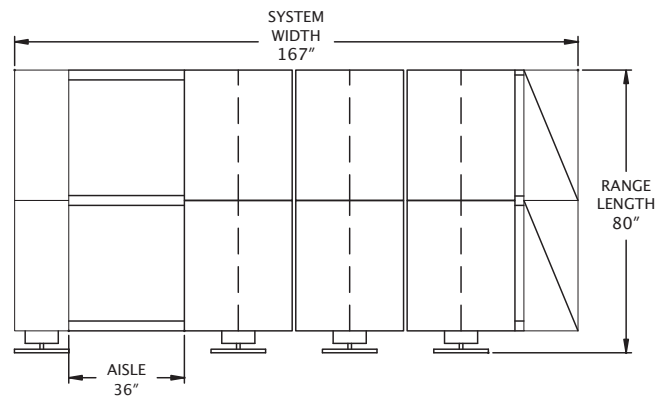

Top View of System Ranges