

Office Doctor Discount Office Furniture

www.OfficeDr.com 856-368-9085

Safco Products are on Sale for Half Price

Take Half Off the List Prices in this PDF

Call 856-368-9085 Now to Order

LIMITED LIFETIME WARRANTY

Safco-warranty obligation: We pledge to repair or replace, at Safco's option, any Safco product or component that is defective in material or workmanship for as long as you, the original purchaser, own it.

LIABILITY LIMITATIONS

The following listed parts, components and supplies are covered under warranty in accordance with the below schedule following the product purchase date.

Ten Years: Seating controls and cylinders, Rumba™, Cha-Cha™, electric height-adjustable table series laminates, and wood seating components. All parts (excluding motor) on the XR, ML and E Series Height-Adjustable Tables.

Five Years: Glides, casters, polymer-based components, seating upholstery (fabrics and leather), foam, armrests, chrome seating components, user-adjustable work surface mechanisms, laminates, veneer finishes and other covering materials, drawer glides, electrical components, Event Series, cabinets or mobile systems, components that are either moving parts or controls (guides that are in contact with moving parts), and motors on the ML-Series, E-Series and XR-Series Height-Adjustable Tables.

Three Years: Outdoor Products (Evos™, Canmeleon™ and CoGo™ Product Lines), High Density 4-Post wire shelving and wire components, and electrical components, Dry Erase Surfaces.

[See website for complete Warranty Information](#)

- **Frames:** Heavy-duty 1" x 2" 11-gauge welded steel, slotted on both sides in 1" increments. Frames can be bolted together as needs expand. 800 lb. maximum load per frame. **Note:** Frame heights are for frame only. Must add 3" for foot and 6" for caster and foot. **Note:** Add frame braces #350325 R (RH) and #350325L (LH) for structural rigidity on 72" and 84" height frames
 - **Shelves:** 14-gauge steel with integral attachment brackets. Available either horizontal or with 13° tilt. Floor shelf for CPU requires either glide or caster kit. 300 lb. maximum load per shelf
 - **Work Surface:** 1" Thermally-Fused Fog Gray laminate with T-mold edge standard. Also available in 1/8" high pressure laminate or ESD laminate with T-mold edge (does not include grounding wire) Support brackets included. Additional front support leg suggested for loads over 150 lbs. Support leg included with 36" deep work surfaces
 - **Keyboard supports:** Available in four variations — single wire holder or double wire holder for mounting under steel shelves; retractable platform or keyboard drawer for mounting under work surface
- Available in Safco® Corporate Colors see page 10 or go to Safcoproducts.com for more information

PRECONFIGURED MATRIX® LAN STATION: TYPICALS

Safco offers three preconfigured Maytrix LAN stations to meet a variety of systems needs. **Each ships in a single carton.**
Color: Gray powder coat paint finish, with Fog Gray low pressure laminate surfaces only for preconfigured units.

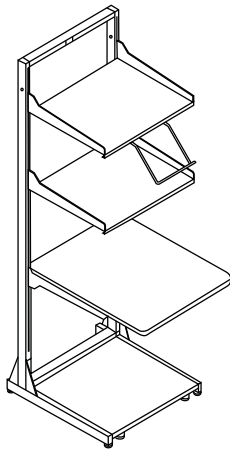

31124

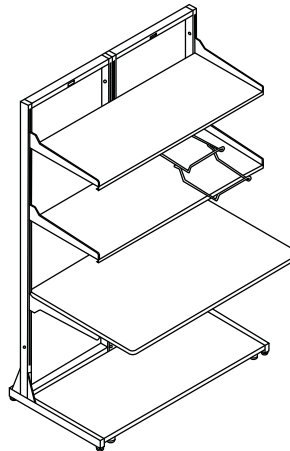

31148

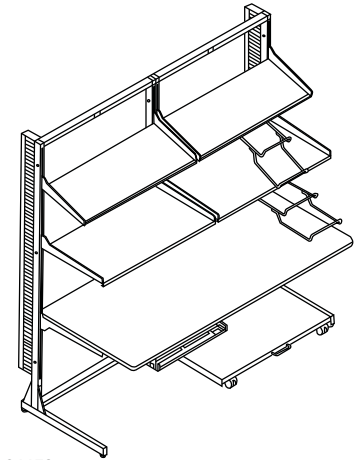

31172

Model No.	Description	Weight	List Price
31124	24" Basic Maytrix (1) 24" x 72" Frame; (2) Single-Sided Legs; (2) 24" x 16" Horizontal Shelves; (1) Single Wire Keyboard Holder; (1) 24" x 30" Work Surface; (1) 18" x 21" Floor Shelf; (1) Floor Shelf Glide Kit	119	3,901.00
31148	48" Maytrix Console (2) 24" x 72" Frames; (2) Single-Sided Legs; (1) Center Support Foot; (2) 48" x 16" Horizontal Shelves; (1) Double Wire Keyboard Holder; (1) 48" x 30" Work Surface; (1) 42" x 21" Floor Shelf; (1) Floor Shelf Glide Kit	211	6,609.00
31172	72" Deluxe Maytrix (2) 36" x 72" frames; (2) Single-Sided Legs; (1) Center Support Foot; (2) 36" x 16" Tilt Shelves; (2) 36" x 16" Horizontal Shelves; (2) Double Wire Keyboard Holders; (1) 72" x 30" Work Surface; (1) Under Surface Keyboard Drawer; (1) 30" x 21" Floor Shelf; (1) Floor Shelf Caster Kit; (2) 6 ft. Slotted Cable Management Channels	270	9,774.00

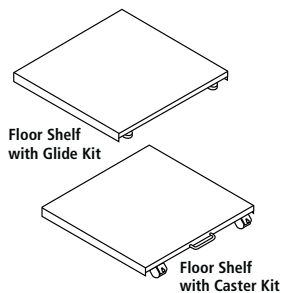
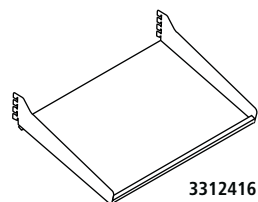
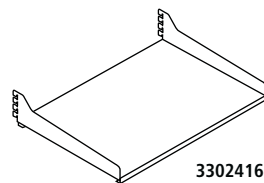
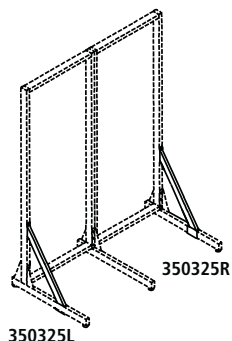
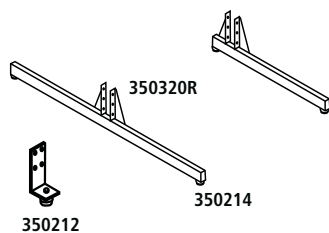
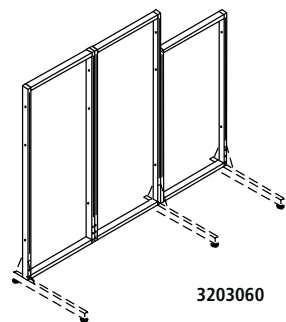

Model No.	Description	Weight	List Price
Maytrix Steel Frames			
3202460	Frame, 24"W x 60"H	36	942.00
3202472	Frame, 24"W x 72"H	40	1,011.00
3202484	Frame, 24"W x 84"H	44	1,111.00
3203060	Frame, 30"W x 60"H	39	971.00
3203072	Frame, 30"W x 72"H	43	1,032.00
3203084	Frame, 30"W x 84"H	48	1,135.00
3203660	Frame, 36"W x 60"H	40	1,004.00
3203672	Frame, 36"W x 72"H	47	1,050.00
3203684	Frame, 36"W x 84"H	48	1,153.00

Model No.	Description	Weight	List Price
Maytrix Leg Options			
350212	Foot, Center Support	2	143.00
350213R	Leg, Single Right (for use with 30" deep work surfaces)	7	470.00
350213L	Leg, Single Left (for use with 30" deep work surfaces)	7	470.00
350320R	Leg, Single Right (for use with 36" deep work surfaces)	7	470.00
350320L	Leg, Single Left (for use with 36" deep work surfaces)	7	470.00
350214	Leg, Double-Sided (universal fits L or R)	11	585.00
350215	Casters for Frame (pair-1 lock, 1 non-lock)	4	228.00
350325R	Frame Brace, Right	4	232.00
350325L	Frame Brace, Left	4	232.00

Model No.	Description	Weight	List Price	Model No.	Description	Weight	List Price
Maytrix Horizontal Mounting Shelf, steel (includes mounting brackets)							
3302416	24"W x 16"D	16	343.00	3302420	24"W x 20"D	16	400.00
3303016	30"W x 16"D	19	418.00	3303020	30"W x 20"D	16	496.00
3303616	36"W x 16"D	20	537.00	3303620	36"W x 20"D	24	564.00
3304816	48"W x 16"D	27	780.00	3304820	48"W x 20"D	27	811.00
3305416	54"W x 16"D	27	824.00	3305420	54"W x 20"D	27	859.00
3306016	60"W x 16"D	32	873.00	3306020	60"W x 20"D	38	920.00
350318	Replacement Center Mounting Bracket (48", 60" only)						161.00

Model No.	Description	Weight	List Price	Model No.	Description	Weight	List Price
Maytrix 13° Tilt Shelf, steel (includes mounting brackets)							
3312416	24"W x 16"D	16	506.00	3312420	24"W x 20"D	19	526.00
3313016	30"W x 16"D	19	593.00	3313020	30"W x 20"D	19	617.00
3313616	36"W x 16"D	21	666.00	3313620	36"W x 20"D	19	695.00

Model No.	Description	Weight	List Price
Maytrix Floor Shelf, steel			
3322421	Floor Shelf, 18"W x 21"D, Fits 24"W Frame	14	596.00
3323021	Floor Shelf, 24"W x 21"D, Fits 30"W Frame	16	593.00
3323621	Floor Shelf, 30"W x 21"D, Fits 36"W Frame	19	604.00
3324821	Floor Shelf, 42"W x 21"D, Fits 48"W Frame	26	649.00
3326021	Floor Shelf, 54"W x 21"D, Fits 60"W Frame	30	697.00
350218	Floor Shelf Caster Kit (2 lock, 2 non-lock) + Handle	2	77.00
350216	Floor Shelf Glide Kit (set of 4)	1	89.00

MAYTRIX DESK WORK SURFACE

- Includes mounting brackets
- 36" D surfaces include adjustable front support legs

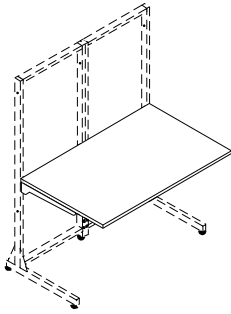

Model No.	Description	Weight	TFL Laminate	HPL Laminate	ESD Laminate
			List Price	List Price	List Price
			"L" Suffix	"LE" Suffix	
3402430	Work Surface, 24"W x 30"D	24	808.00	1,050.00	1,491.00
3403030	Work Surface, 30"W x 30"D	30	916.00	1,196.00	1,644.00
3403630	Work Surface, 36"W x 30"D	34	1,011.00	1,312.00	1,776.00
3404830	Work Surface, 48"W x 30"D	45	1,209.00	1,598.00	2,088.00
3405430	Work Surface, 54"W x 30"D	45	1,385.00	1,807.00	2,379.00
3406030	Work Surface, 60"W x 30"D	56	1,577.00	2,006.00	2,538.00
3407230	Work Surface, 72"W x 30"D	78	1,718.00	2,177.00	2,736.00
3409030	Work Surface, 90"W x 30"D	96	2,177.00	2,806.00	3,415.00
3402436	Work Surface, 24"W x 36"D	29	1,091.00	1,240.00	1,628.00
3403036	Work Surface, 30"W x 36"D	33	1,166.00	1,593.00	1,776.00
3403636	Work Surface, 36"W x 36"D	42	1,295.00	1,549.00	2,042.00
3404836	Work Surface, 48"W x 36"D	64	1,453.00	1,879.00	2,486.00
3405436	Work Surface, 54"W x 36"D	66	1,809.00	2,120.00	2,796.00
3406036	Work Surface, 60"W x 36"D	67	1,812.00	2,357.00	3,106.00
3407236	Work Surface, 72"W x 36"D	75	2,051.00	2,568.00	3,392.00
3409036	Work Surface, 90"W x 36"D	90	2,537.00	3,291.00	4,359.00

Note: TFL = Low Pressure Laminate as standard.

MAYTRIX PENINSULA

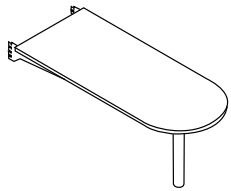

Model No.	Description	Weight	TFL Laminate	HPL Laminate	ESD Laminate
			List Price	List Price	List Price
			"L" Suffix	"LE" Suffix	
Maytrix Peninsula (includes mounting brackets - hooks onto Maytrix™ frame)					
3407130	71" L x 30"W with T-mold Edge	83	1,733.00	2,213.00	2,510.00

Note: Post-formed edge not available on peninsula surface. Surface height must be set nominally at 29".

MAYTRIX 90° CORNER WORK SURFACES

Model No.	Description	Weight	List Price
Maytrix Corner Components - Shelves			
3332416	90° Steel Corner Shelf, 24"W x 16"D (requires two 24" frames)	20	532.00
3332420	90° Steel Corner Shelf, 24"W x 20"D (requires two 24" frames)	22	543.00
3333016	90° Steel Corner Shelf, 30"W x 16"D (requires two 30" frames)	22	549.00
3333616	90° Steel Corner Shelf, 36"W x 16"D (requires two 36" frames)	25	573.00
3333020	90° Steel Corner Shelf, 30"W x 20"D (requires two 30" frames)	25	573.00
3333620	90° Steel Corner Shelf, 36"W x 20"D (requires two 36" frames)	28	591.00

MAYTRIX® 90° CORNER WORK SURFACES 

Model No.	Description	TFL Laminate List Price	HPL Laminate List Price	ESD Laminate List Price
			"L" Suffix	"LE" Suffix
3403030	30"W x 30"D (requires two 30" frames; 350213L/350213R legs recommended).	916.00	1,196.00	1,644.00
3403636	36"W x 36"D (requires two 36" frames; 350213L/350213R legs recommended)	1,295.00	1,549.00	2,042.00
3434830	48"W x 30"D (requires four 24" frames)	1,765.00	2,148.00	2,510.00
3434836	48"W x 36"D (requires four 24" frames)	1,962.00	2,346.00	2,668.00

Model No.	Description	List Price	List Price
350217	Corner Connector Kit (foot and hardware required for 90° corner configuration)	236.00	236.00

HOW TO SPECIFY

Start with base model number for work surfaces or peninsula and **SELECT ONE CODE FROM EACH OF THE OPTIONS** to complete your final model number for ordering:

Select MODEL NUMBER (ie., 3403030)	Option 1 Thermally-Fused Laminate No suffix	Option 2 High Pressure Laminate L = HPL Laminate	Option 3 ESD Laminate LE = ESD Laminate
------------------------------------	--	---	--

The final model number for a surface with the base model number of 3403030 with the ESD Laminate option would be 3403030LE.

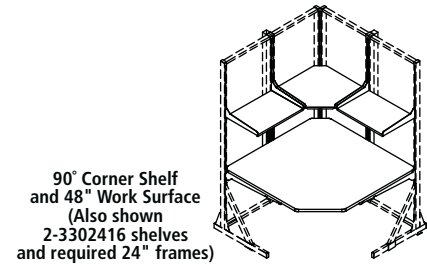
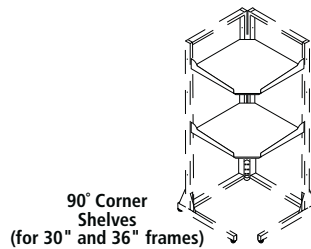
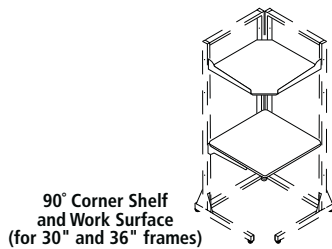

STORAGE BINS 

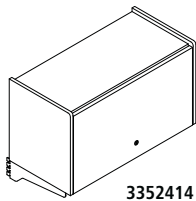

Model No.	Description	Internal Dimensions	Weight	TFL Laminate List Price	HPL Laminate List Price
					"L" Suffix
3352414	24"W Storage Bin	13"H x 21¼"W x 13¼"D	40	1,641.00	1,737.00
3353014	30"W Storage Bin	13"H x 27¼"W x 13¼"D	4	1,667.00	1,764.00
3353614	36"W Storage Bin	13"H x 33¼"W x 13¼"D	51	1,716.00	1,838.00

ESD ACCESSORIES 

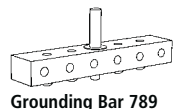

- Must be wired in compliance with local electrical codes
- Grounding Bar provides common grounding point for managing multiple ground wires
- Wrist Strap must be used with Grounding Jack for proper grounding
- Grounding Jack accommodates 4 standard banana jacks (on the end of wrist straps)

Model No.	Description	Weight	List Price
787	ESD Wrist Strap	2	145.00
788	ESD Grounding Jack	3	159.00
789	ESD Grounding Bar	.5	248.00

Office Suites
Seating
Tables & Desks
Meeting Essentials
Personal Organization
Ergonomics
High Density Storage
Storage & Filing
Facilities
Technology Furniture
Art & Engineering
K-12 Education
SAFE Collection Addendum

MAYTRIX LAN RACKING SYSTEM

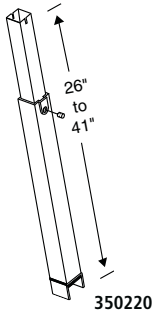

Model No.	Description	Weight	List Price
350220	Adjustable Front Support Leg - All Work Surfaces	4	304.00
350321R	Replacement Top Bracket (right) - 30"D and 36"D Work Surfaces	4	161.00
350321L	Replacement Top Bracket (left) - 30"D and 36"D Work Surfaces	4	161.00
350327R	Replacement Top Bracket (right) - All 24"D Work Surfaces	4	172.00
350327L	Replacement Top Bracket (left) - All 24"D Work Surfaces	4	172.00

Note: Adjustable front support leg recommended for all corner and 36" deep work surfaces.

Maytrix Power Accessories

Model No.	Description	Weight	List Price
350181	72" L, 24 Outlet Power Strip, 15 amp, 15' Cord	4.5	579.00
350173	Power Strip, 4 ft. (10 outlets) with Surge Suppressor, 15 amp - 450 joules	5	702.00
A7737	Hardware Bags for mounting		17.00

Maytrix Keyboard Accessories

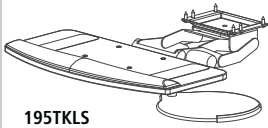

Model No.	Description	Weight	List Price
195TKLS	Trackless Keyboard/Mouse Platform 19"W x 9 1/4"D, 9" Dia. Mouse Platform Available in Black or White.	14	859.00

Maytrix Cable Management System

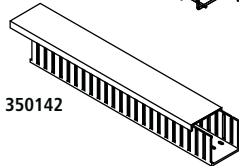
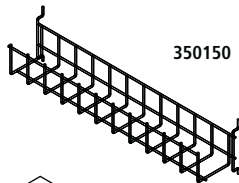

Model No.	Description	Weight	List Price
350142	2"W x 2"D, Channel (slotted), 6 ft. - Black only	3	338.00
350117	Pop Rivets - pkg. of 25 (to attach cable channels)	1	30.00
350150	24"W, Wire Cable Trough	1	224.00
350151	30"W, Wire Cable Trough	2	288.00
350152	36"W, Wire Cable Trough	2.5	386.00

Office Suites
Seating
Tables & Desks
Meeting Essentials
Personal Organization
Ergonomics
High Density Storage
Storage & Filing
Facilities
Technology Furniture
Art & Engineering
K-12 Education
SAFE Collection Addendum

MAYTRIX FABRIC SCREEN 

- Installs between Maytrix steel frame sections to create a private work environment

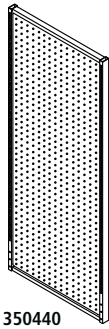

350440

Model No.	Dimensions	Weight	List Price
350440	24"W x 72"H x 1¼"D	58	1,416.00
350445	30"W x 72"H x 1¼"D	75	1,806.00
350450	36"W x 72"H x 1¼"D	92	1,901.00
350460	24"W x 60"H x 1¼"D	48	1,282.00
350465	30"W x 60"H x 1¼"D	62	1,668.00
350470	36"W x 60"H x 1¼"D	76	1,759.00
350480	24"W x 84"H x 1¼"D	68	1,598.00
350485	30"W x 84"H x 1¼"D	88	1,989.00
350490	36"W x 84"H x 1¼"D	107	2,078.00

HOW TO ORDER MAYTRIX® FABRIC SCREENS

FABRIC SCREEN OPTIONS

When ordering fabric screens, use the code at right to indicate your fabric option:

3 5 0 4 4 0 S T Y		
Product Code	Fabric Option	

Fabric Color Options

Fabric Color	Order Code
Spinel	
Tiger Eye	STY
Sand Stone	SSS
Guilden	SGL
Lido	
Balboa	LBB
Heartland	LHL
Bryce Canyon	LBC
Mingle	
Crystal	MCT
Khaki	MHK
Biscuit	MBT
Cross Town	
Buff	CBF
Ray	CRA
Fieldstone	CFS
Anchorage	
Goose	AGS
Bailey	
Khaki	BKH

Contact Customer Care at 1-888-971-6225 or email info@safcoproducts.com for assistance.

S/E Cabinet

S/E CABINET 

- The S/E Cabinet comes fully assembled, just add shelves at the spacings desired
- 3 shelves included (standard on DSP models) and adjust on 1" increments
- Optional single shelf kit available to add additional shelves to cabinet
- Empty cabinet version available (no shelves)
- Perforated locking doors with 4 hinges each
- 30" D cabinet with steel back panel and two 3" dia. pop-outs
- Tamper-proof hinges inside cabinet, not accessible from outside
- Hinge will hold doors open or keep closed without engaging the lock
- Great for storing electrical equipment due to the ventilated design and pop-outs at rear of cabinet for power purposes
- Available in Black, Graphite and Desert Sage

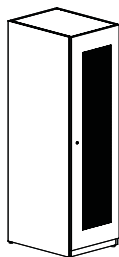

2480DSP

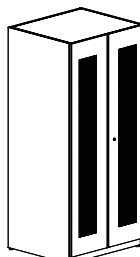

3680DSP

Model No.	Description	Dimensions	Weight	List Price
3680DSP	36"W, Double-Door Cabinet, includes 3 Shelves	36"W x 31"D x 80"H	307	9,785.00
2480DSP	24"W, Single-Door Cabinet, includes 3 Shelves	24"W x 31"D x 80"H	279	7,588.00
36801S	36"W, Single Shelf Kit for 36"W Cabinet	34"W x 28¾"D x 1"H	17	453.00
24801S	24"W, Single Shelf Kit for 24"W Cabinet	22"W x 28¾"D x 1"H	14	383.00