

Office Doctor Discount Office Furniture

www.OfficeDr.com 856-368-9085

Safco Products are on Sale for Half Price

Take Half Off the List Prices in this PDF

Call 856-368-9085 Now to Order

LIMITED LIFETIME WARRANTY

Safco-warranty obligation: We pledge to repair or replace, at Safco's option, any Safco product or component that is defective in material or workmanship for as long as you, the original purchaser, own it.

LIABILITY LIMITATIONS

The following listed parts, components and supplies are covered under warranty in accordance with the below schedule following the product purchase date.

Ten Years: Seating controls and cylinders, Rumba™, Cha-Cha™, electric height-adjustable table series laminates, and wood seating components. All parts (excluding motor) on the XR, ML and E Series Height-Adjustable Tables.

Five Years: Glides, casters, polymer-based components, seating upholstery (fabrics and leather), foam, armrests, chrome seating components, user-adjustable work surface mechanisms, laminates, veneer finishes and other covering materials, drawer glides, electrical components, Event Series, cabinets or mobile systems, components that are either moving parts or controls (guides that are in contact with moving parts), and motors on the ML-Series, E-Series and XR-Series Height-Adjustable Tables.

Three Years: Outdoor Products (Evos™, Canmeleon™ and CoGo™ Product Lines), High Density 4-Post wire shelving and wire components, and electrical components, Dry Erase Surfaces.

[See website for complete Warranty Information](#)

ARC™ Rotary File & Empty Cabinet

Safco® Products marketing materials are designed to be used as sales tools for our Dealer network.

The ARC™ Rotary File is a double faced unit that rotates easily to provide access to both sides. Using our flexible cantilever style shelving, the ARC provides the most unobstructed filing inches per level and the easiest installation possible. The Complete Starter includes everything needed to house a filing system including the specified number of shelves and dividers. See page 10 Corporate Color Program, paint colors and laminates or go to Safco website to view color swatches.

- Allow 5¼" (letter depth) or 6½" (legal depth) clearance from wall for rotating carriage
- Empty units can be configured in endless variations for mixed media storage solutions
- Alley clearance needed 36"
- Shelves adjust on 1½" H increments; 120 lb. weight capacity per shelf
- Complete Units are ideal for storing color-coded filing
- To order a fully assembled unit, add the letter "B" after the letter "C" in the part number (e.g. ARCB24403S)
- ARC top is unfinished. Work surfaces are available - see page 184
- Complete units have slotted shelves with two (2) file dividers per 24" wide shelf; three (3) file dividers per 30" wide shelf
- S: Starter, A: Adder
- Standard Lock on all cabinets comes keyed alike
- Adder units attach to either right or left side of starter unit

PRECONFIGURED IDEA STARTERS

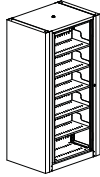

Model No.	W	D	H	Wt.	Knockdown List Price	Assembled Model No.	Assembled List Price "B"
6-Tier Complete							
Letter (288 LFI)							
ARC24726S	37¼"	26¼"	73"	403	5,519.00	ARCB24726S	6,292.00
ARC24726A	31¾"	26¼"	73"	347	5,061.00	ARCB24726A	5,833.00
Legal (360 LFI)							
ARC30726S	46"	32¼"	73"	542	6,974.00	ARCB30726S	7,755.00
ARC30726A	39¼"	32¼"	73"	478	6,426.00	ARCB30726A	7,217.00

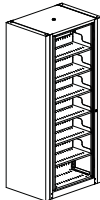

7-Tier Complete							
Letter (336 LFI)							
ARC24827S	37¼"	26¼"	83½"	427	6,249.00	ARCB24827S	7,035.00
ARC24827A	31¾"	26¼"	83½"	365	5,742.00	ARCB24827A	6,524.00
Legal (420 LFI)							
ARC30827S	46"	32¼"	83½"	588	7,750.00	ARCB30827S	8,523.00
ARC30827A	39¼"	32¼"	83½"	516	6,991.00	ARCB30827A	7,908.00

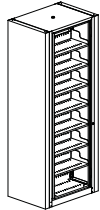

8-Tier Complete							
Letter (384 LFI)							
ARC24938S	37¼"	26¼"	94"	478	7,013.00	N/A	N/A
ARC24938A	31¾"	26¼"	94"	408	6,463.00	N/A	N/A
Legal (480 LFI)							
ARC30938S	46"	32¼"	94"	632	8,555.00	N/A	N/A
ARC30938A	39¼"	32¼"	94"	550	7,958.00	N/A	N/A

ARC™ Rotary File - Empty Cabinet

See page 10 for Safco Corporate Color Program, Laminates and Paint colors or go to Safco website to view color swatches
Contact your local Safco Sales Rep Group to discuss space planning specific application, obtain prior approval and quote.

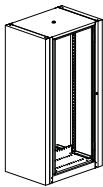

Model No.	W	D	H	Wt.	Knockdown List Price	Assembled Model No.	Assembled List Price "B"
6-Tier Empty							
Letter							
ARC24726ES	37¼"	26¼"	73"	303	4,295.00	ARCB24726ES	5,053.00
ARC24726EA	31¾"	26¼"	73"	247	3,852.00	ARCB24726EA	4,704.00
Legal							
ARC30726ES	46"	32¼"	73"	399	5,297.00	ARCB30726ES	6,182.00
ARC30726EA	39¼"	32¼"	73"	335	4,861.00	ARCB30726EA	5,644.00

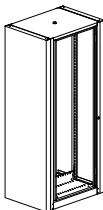

7-Tier Empty							
Letter							
ARC24827ES	37¼"	26¼"	83½"	323	4,912.00	ARCB24827ES	5,529.00
ARC24827EA	31¾"	26¼"	83½"	261	4,407.00	ARCB24827EA	5,036.00
Legal							
ARC30827ES	46"	32¼"	83½"	423	5,930.00	ARCB30827ES	6,634.00
ARC30827EA	39¼"	32¼"	83½"	351	5,343.00	ARCB30827EA	6,053.00

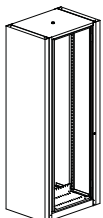

8-Tier Empty							
Letter							
ARC24938ES	37¼"	26¼"	94"	345	5,470.00	N/A	N/A
ARC24938EA	31¾"	26¼"	94"	275	4,935.00	N/A	N/A
Legal							
ARC30938ES	46"	32¼"	94"	437	6,648.00	N/A	N/A
ARC30938EA	39¼"	32¼"	94"	355	5,934.00	N/A	N/A

• Not available assembled

Contact your local Safco Sales Rep Group to discuss space planning specific application, obtain prior approval and quote.

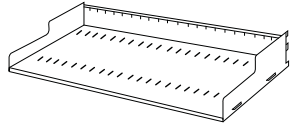

GSA

Model No.	W	H	D	Wt.	List Price
Slotted Shelves (SLF)					
ARC2412SLF	24"	6"	12"	8	111.00
ARC3015SLF	30"	6"	15"	12	135.00

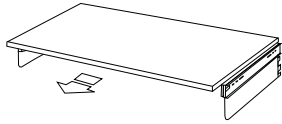

GSA

Model No.	W	H	D	Wt.	List Price
Pull Out Reference Shelves (RS)					
ARC2412RS	24"	—	12"	20	464.00
ARC3015RS	30"	—	15"	23	486.00

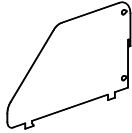

GSA

Model No.	W	H	D	Wt.	List Price
Adjustable File Dividers(DV) – Standard Pack of 6					
F12DV6	—	6"	12"	6	67.00
F15DV6	—	6"	15"	7.5	76.00

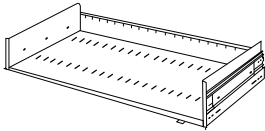

GSA

Model No.	W	H	D	Wt.	List Price
Rollout Shelves (ROSLF)					
ARC2412ROSLF	24"	6"	12"	22	464.00
ARC3015ROSLF	30"	6"	15"	25	528.00

Note: When ordering rollout accessories, **Upright Rollout Supports** must be ordered for each side of the ARC™ Rotary File with installed rollout accessories. (See page 176)

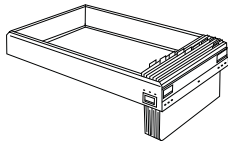

GSA

Model No.	W	H	D	Wt.	List Price
Rollout Hanging Frames (ROHF)					
ARC2412ROHF	24"	—	12"	12.5	464.00
ARC3015ROHF	30"	—	15"	13.5	484.00

Note: When ordering rollout accessories, **Upright Rollout Supports** must be ordered for each side of the ARC™ Rotary File with installed rollout accessories. (See page 176)

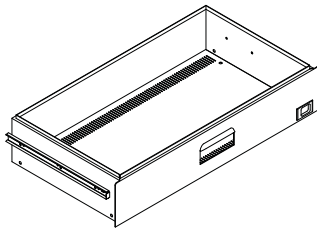

GSA

Model No.	H	D	Wt.	List Price
Rollout Drawers (ROD)				
ARC2412ROD105	10 1/2"	12"	32	552.00
ARC3015ROD105	10 1/2"	15"	36	589.00
ARC2412ROD120	12"	12"	37	600.00
ARC3015ROD120	12"	15"	41	643.00

Note: When ordering rollout accessories, **Upright Rollout Supports** must be ordered for each side of the ARC™ Rotary File with installed rollout accessories. (See below)

Office Suites
Seating
Tables & Desks
Meeting Essentials
Personal Organization
Ergonomics
High Density Storage
Storage & Filing
Facilities
Technology Furniture
Art & Engineering
K-12 Education
SAFE Collection Addendum

Contact your local Safco Sales Rep Group to discuss space planning specific application, obtain prior approval and quote.

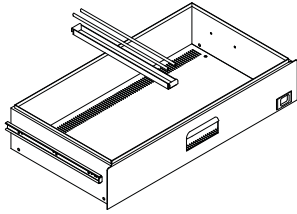

Converter Bar (CB) GSA

Use with rollout drawers or hanging frame kits
To file front-to-back, use the following converter bars:

- Sold individually, not in pairs

Model No.	D	Wt.	List Price
ARC12CB	12"	1	101.00
ARC15CB	15"	1	108.00

Upright Rollout Supports (sold in pairs) GSA

Required on each side of ARC™ Rotary File with Rollout Components

Model No.	Description	List Price
URS6	6-Tier Supports	132.00
URS7	7-Tier Supports	132.00
URS8	8-Tier Supports	132.00

Order 2 pair if filling both sides of the cabinet.

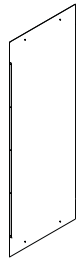

Center Panels (CP) GSA

Used as security or privacy panel between front and back sections of cabinet.

Model No.	W	H	Wt.	List Price
ARC2472CP	23"	6-tier	19	269.00
ARC3072CP	29"	6-tier	24	285.00
ARC2482CP	23"	7-tier	22	290.00
ARC3082CP	29"	7-tier	28	312.00
ARC2493CP	23"	8-tier	25	336.00
ARC3093CP	29"	8-tier	32	363.00

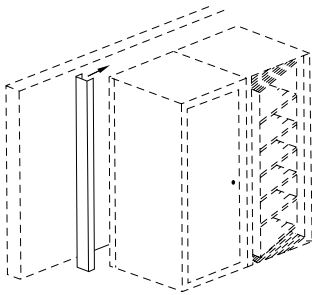

Wall Closure Strips (WCS) GSA

Closes space between ARC™ unit and wall. Letter: 5 1/4", Legal: 6 1/2".

Model No.	Size	H	Wt.	List Price
ARC2472WCS	LTR	6-tier	18	151.00
ARC3072WCS	LGL	6-tier	20	151.00
ARC2482WCS	LTR	7-tier	23	181.00
ARC3082WCS	LGL	7-tier	28	177.00
ARC2493WCS	LTR	8-tier	27	210.00
ARC3093WCS	LGL	8-tier	30	210.00

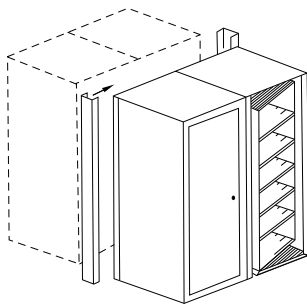

Back-to-Back Closure Strips (BTB) GSA

Used to enclose the space between two ARC™ units when placed back-to-back.
Letter: 10 1/2", Legal: 13".

Model No.	Size	H	Wt.	List Price
ARC2472BTB	LTR	6-tier	32	181.00
ARC3072BTB	LGL	6-tier	32	181.00
ARC2482BTB	LTR	7-tier	40	210.00
ARC3082BTB	LGL	7-tier	40	206.00
ARC2493BTB	LTR	8-tier	48	233.00
ARC3093BTB	LGL	8-tier	48	238.00

Contact your local Safco Sales Rep Group to discuss space planning specific application, obtain prior approval and quote.

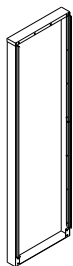

GSA End Panel Assemblies (EP)

Model No.	Size	H	Wt.	List Price
ARC2472EP	LTR	6-tier	29	731.00
ARC3072EP	LGL	6-tier	33	837.00
ARC2482EP	LTR	7-tier	32	837.00
ARC3082EP	LGL	7-tier	37	849.00
ARC2493EP	LTR	8-tier	36	914.00
ARC3093EP	LGL	8-tier	42	994.00

Flip-N-File™ Cabinet

- The Flip-n-File™ Cabinet comes fully assembled and ready to use.
- Shelves are fixed with a 9³/₄" H clearance between shelves
- 120 lb. load capacity per shelf
- Inside width dimension of each shelf is 34"
- Accommodates letter or legal filing
- All units come with 4 file dividers per shelf
- Additional dividers are available
- Lock is located at the top of the cabinet
- Standard Finishes: Pebble Gray, Sand Beige and Black Only
- Inside depth is 15¹/₁₆"

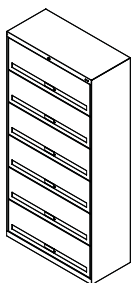

Model No.	Description	W	Size H	D	Wt.	List Price	List Price Add "K" Suffix Keyed Alike
FFD5	5 Tier with Doors	36"	63 ¹ / ₂ "	17"	160	3,721.00	3,747.00
FFD6	6 Tier with Doors	36"	75 ¹ / ₄ "	17"	186	4,123.00	4,067.00
FFD7	7 Tier with Doors	36"	87"	17"	212	4,753.00	4,856.00
FFD	Additional Dividers					3.00	-
FFDMK	Master Key				1	34.00	-

Note: For keyed alike cabinets, add a "K" to the end of the model number. See final column for keyed alike pricing (with door only).

Flip-N-File™ Cabinets on Kwik-Track

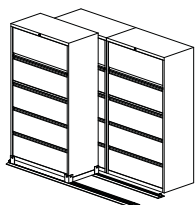

To increase filing density, Flip-n-File™ shelving can also mount to Kwik-Track systems creating either a bi-file or tri-file sliding shelving system. In either configuration, the rear row of cabinets are stationary with cabinets in front mounted on a sliding carriage on a track mounted to floor.

- Heavy-duty aluminum track construction supports 3,500 lbs. per carriage
- Anti-tip built into base for stability and easy installation
- Systems are complete with cabinets and track. Four dividers per shelf are included
- Track system has a Brushed Aluminum finish. Floor mounting hardware included
- Track adds 2³/₄" to overall height of system
- All configurations below have doors

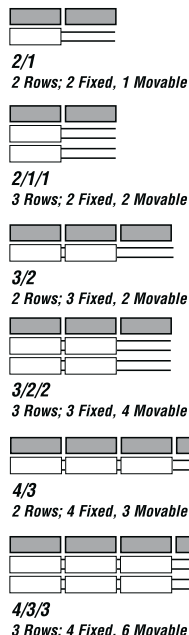

Model No.	Description	Dimensions	Wt.	List Price	List Price Add "K" Suffix Keyed Alike
5-Tier Cabinet 36"D					
FF521	2/1 5-Tier Cabinet	78"W x 36"D x 66 ¹ / ₄ "H	505	12,854.00	-
FF532	3/2 5-Tier Cabinet	116"W x 36"D x 66 ¹ / ₄ "H	840	-	22,281.00
FF543	4/3 5-Tier Cabinet	156"W x 36"D x 66 ¹ / ₄ "H	1,165	30,418.00	-
5-Tier Cabinet 56"D					
FF5322	3/2/2 5-Tier Cabinet	116"W x 56"D x 66 ¹ / ₄ "H	1,150	33,050.00	-
6-Tier Cabinet 36"D					
FF621	2/1 6-Tier Cabinet	78"W x 36"D x 78"H	583	14,404.00	-
FF632	3/2 6-Tier Cabinet	116"W x 36"D x 78"H	970	24,099.00	24,326.00
6-Tier Cabinet 56"D					
FF6322	3/2/2 6-Tier Cabinet	116"W x 56"D x 78"H	1,332	35,671.00	36,102.00
7-Tier Cabinet 36"D					
FF721	2/1 7-Tier Cabinet	78"W x 36"D x 89 ³ / ₄ "H	661	-	16,524.00
FF732	3/2 7-Tier Cabinet	116"W x 36"D x 89 ³ / ₄ "H	1,100	26,574.00	-
FF743	4/3 7-Tier Cabinet	156"W x 36"D x 89 ³ / ₄ "H	1,529	37,174.00	37,845.00
7-Tier Cabinet 56"D					
FF7211	2/1/1 7-Tier Cabinet	78"W x 56"D x 89 ³ / ₄ "H	868	23,078.00	-
FF7322	3/2/2 7-Tier Cabinet	116"W x 56"D x 89 ³ / ₄ "H	1,514	39,803.00	-

Note: For keyed alike cabinets, add a "K" to the end of the model number. See final column for keyed alike pricing.

Office Suites
Seating
Tables & Desks
Meeting Essentials
Personal Organization
Ergonomics
High Density Storage
Facilities
Technology Furniture
Art & Engineering
K-12 Education
SAFE Collection Addendum