

## Office Doctor Discount Office Furniture

[www.OfficeDr.com](http://www.OfficeDr.com) 856-368-9085

Groupe Lacasse Half Price Sale On Now

Take Half Off the List Prices in this PDF

**Call 856-368-9085 Now**

Free Layout & Design Service

Think Smart Educational Series



# THINK SMART

## EDUCATIONAL FURNITURE

### EDGEBANDING

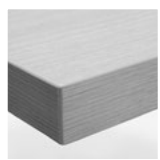

**N** EDGE

Furniture with 1" and 1½" (25 and 38 mm) thick tops.

Smooth, ¼" (1,5 mm) thick edge.

The **N** edge is **matched with the finish specified for the surface.**

### DOOR INSERTS



**T** – TRANSLUCENT

### HANDLES

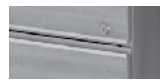

**L** – LINEAR



**Q** – SQUARE



**V** – ROUND

Exceptions: L handle is not compatible on furniture with aluminum framed translucent doors or on the metal doors of laptop carts.

Exceptions: The modular cabinets with single door are only available with Q and V handles.

### LEGS



**Q** – SQUARE



**V** – ROUND

### ACCENT COLORS



**S** – SILVER



**A** – ANTHRACITE GREY

The accent color applies to non-laminate components such as bases, handles, grommets, ventilation grids, laptop cart metal doors and wall cabinet hardware.

Exceptions: Power units, translucent doors and aluminum legs on benches are available in Silver anodized aluminum only.

Steel shelves are available painted Anthracite grey only.

### CODIFICATION

SERIES	OPTIONS			
	THICKNESS	HANDLES	ACCENT COLORS	LEGS
<b>E</b>	<b>1</b> Thermofused laminate 1"	<b>N</b> N/A	<b>N</b> N/A	<b>Q</b> Square
	<b>2</b> High-pressure laminate 1"	<b>L</b> Linear	<b>A</b> Anthracite grey	<b>V</b> Round
	<b>5</b> Thermofused laminate 1½"	<b>Q</b> Square	<b>S</b> Silver	
	<b>6</b> High-pressure laminate 1½"	<b>V</b> Round		

## GENERAL SPECIFICATIONS

WITH GROUPE LACASSE DESIGN AND MANUFACTURING CAPABILITIES, THERE IS VERY LITTLE THAT WE CANNOT DO WITH THERMOFUSED LAMINATES – AND WE BELIEVE THAT WE CAN QUOTE AND WIN MOST ARCHITECT AND DESIGNER SPECIFIC PROJECTS.

ALL STANDARD PRODUCTS MEET OR EXCEED ANSI/BIFMA REQUIREMENTS.

### SURFACES

Work surfaces and tops are made of 1" (25 mm) or 1½" (38 mm) thick mar-resistant high-performance laminate (45 lbs/ft<sup>3</sup>) laminated on both faces, also called TFL.

High-pressure laminate work surfaces are available, also called HPL, for certain units, adding ¼" (1,6 mm) to the overall thickness of the work surface.

Side panels are 1" (25 mm) thick.

### EDGE BANDING

Work surfaces are finished with a ¼" (1,5 mm) ABS smooth edgebanding.

### CONSTRUCTION

In a majority of cases, products are assembled with metal-to-metal hardware to facilitate the replacement of parts in case of damage.

### DRAWERS AND DOORS

All drawers built for trouble-free performance.

- Black full extension ball bearing suspensions.
- 100 lbs (45 kg) load capacity for box and file drawers.
- 150 lbs (68 kg) load capacity for lateral file drawers.
- Five sided drawer construction including bottom in ¼" (11 mm) black particleboard. Reinforced rod on 36" (914 mm) wide drawers.
- PVC top rails for lateral file folders.
- Standard interlock system where required.
- 135° hinges on doors.
- 270° hinges are available upon request (contact Groupe Lacasse Quotations Department).

### LOCKS

Cam lock is available on drawers and doors and will match the specified accent color; Black or Silver. Key-alike option is available upon request (contact Groupe Lacasse Customer Service).

## LEVELERS

Levelers allow up to 1/4" (32 mm) height adjustment unless otherwise specified.

## CASTERS

Mobile units have 3" (75 mm) diameter heavy-duty casters made of non-marking synthetic rubber. Load capacity of 176 lbs (80 kg) per caster.

## PROTECTIVE RUBBER BUMPER

Grey rubber bumpers are available for mobile units. Bumpers are sold separately; please refer to the Accessories section, p. 23.

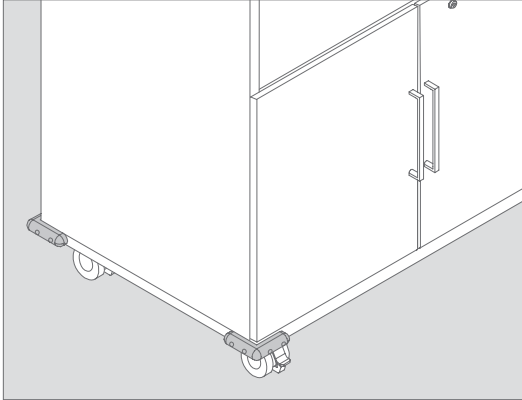

## SHELVES

- 1" (25 mm) thick thermofused laminate shelves have a hidden anti-tip device when there is no door in front of them.
- Metal shelves are made of 18 gauge steel with a load capacity of 150 lbs (68 kg).

## HANDLES

Three choices of handles available in Silver or Anthracite grey finish: Linear (L) thermoplastic (exceptions in some cases) polymer handle, Square (Q) or Round (V) metal pulls.

The LGC-PULL17 handle for mobile units only is sold separately; please refer to p. 16.

## LEGS

Two choices of legs available in Silver or Anthracite grey finish: Square (Q) or Round (V) metal legs.

## BENCH CUSHIONS

2" (51 mm) thick foam cushion installs on bench with Velcro (included). Cushions comply with Cal. 117 requirements.

## TECHNOLOGY INTEGRATION

- Matching Anthracite grey or Silver grommets included on most furniture units.
- Certain teachers' desks include CPU storage units and ventilation grids to accommodate a variety of electronic devices.
- Wire management raceways included on computer carrels, laptop and CPU tables.
- For optional electrical/communication modules; please refer to Accessories section, p. 23.

## DIMENSIONS

Metric dimensions are exact; imperial dimensions are nominal (unless otherwise specified).

## OTHER FINISHES (SPECIAL)

Other finishes (i.e., non standard) may be ordered at an upcharge. Minimum quantity may be required. Please check with our Quotations Department. Delivery may vary depending on the choice of finish or type of material.

## MODULAR CABINETRY

All modular cabinetry must be attached to a wall to ensure stability and security.

## WALL-MOUNTED LAMINATE HANGING SYSTEM

The wall-mounted laminate panel should be installed by a professional. Appropriate hardware must be used to ensure a good and secure installation of the laminate panel to the wall. Panel mount hardware is not included and may vary depending on wall type. The laminate panel should be equal or longer than the length of all of the hanging component(s); i.e., white board, cabinet, etc.

## CABINETS AND ACCESSORIES FOR WALL-MOUNTED HANGING SYSTEM

Hanging components such as white boards, cabinets, bookcases must be securely attached to the wall-mounted laminate panel with the supplied mounting hardware.

THE SYSTEM IS VERY FLEXIBLE AND ALLOWS MANY CONFIGURATIONS, PLANS BELOW ILLUSTRATE THE RECOMMENDED POSITION OF THE STORAGE UNITS.

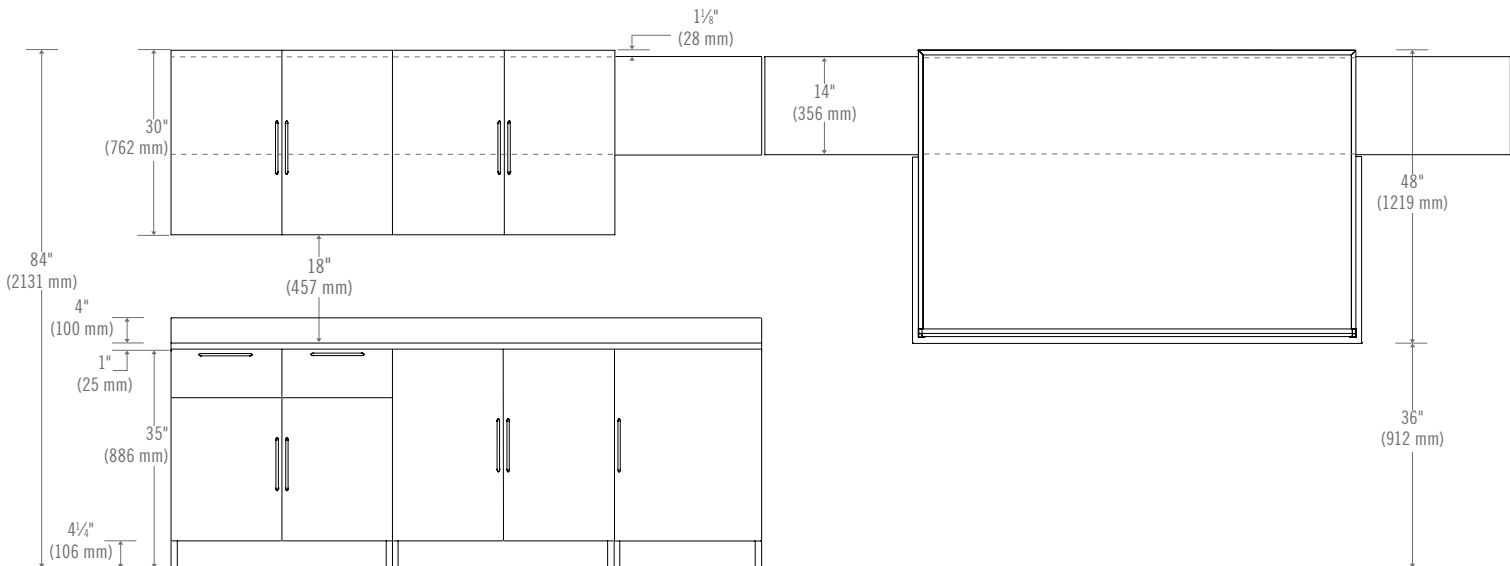

**POWER BAR (LGC-POWERBAR)**

To be used with laptop carts; installs on the back portion of the cart. Maximum input current; 15 AMP, 10 outlets. Surge and overload protection.

A separate wall circuit is recommended for each surge and overload-protected 10-outlet electrical unit.

When the units are plugged into wall outlets, make sure not to exceed circuit capacity (15 to 20 AMP per circuit).

Using a timer to recharge laptops is recommended or using different wall outlets to prevent tripping breaker when all power bar outlets are in use.

UL Recognized - UL 1363  
RoHS Compliancy.

Power bar is sold separately; please refer to p. 13.

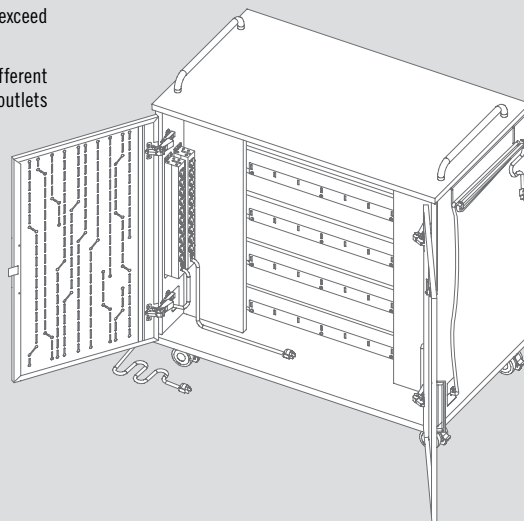

**ELECTRICITY**

4-Trac System is compatible with laptop and CPU tables, as well as all types of carrels.

**4-TRAC SYSTEM FEATURES:**

- 4-wires, 2 circuits, 20 AMP each.
- 13 duplex receptacles per circuit. Maximum of 26 duplex receptacles of 15 AMP per power infeed.
- Easy to specify, install and reconfigure.
- UL listed as a Manufactured Wiring System.
- RoHS Compliancy available upon request; Cradle to Cradle.
- Will work in all locations except for Chicago. Manufactured Wiring Systems are not permitted in Chicago.
- Chicago code compliancy and many other options (8-wire system, etc.) are available upon request; contact Groupe Lacasse Quotations Department.

**HOW TO SPECIFY**

EXAMPLE USING A CONFIGURATION OF LAPTOP TABLES (E\_N\_RLP2460J)

**STEP 1**

Determine the number of users in function of the length of the surface and their electrical requirements (1 or 2 duplex receptacles per workstation are usually sufficient).

LGC-DUPLEXC\_

**STEP 2**

Determine whether 1 or 2 circuits are needed, accordingly to the quantity of duplex receptacles.

**STEP 3**

Determine pass cable lengths in function of duplex receptacle positioning and surface lengths.

LGC-PASS\_ \_

**STEP 4**

Determine electrical feed cable length, between the duplex receptacle and wall power source. The electrical installation must be made by a professional electrician.

LGC-FFEED\_ \_

STEP 1 & 2

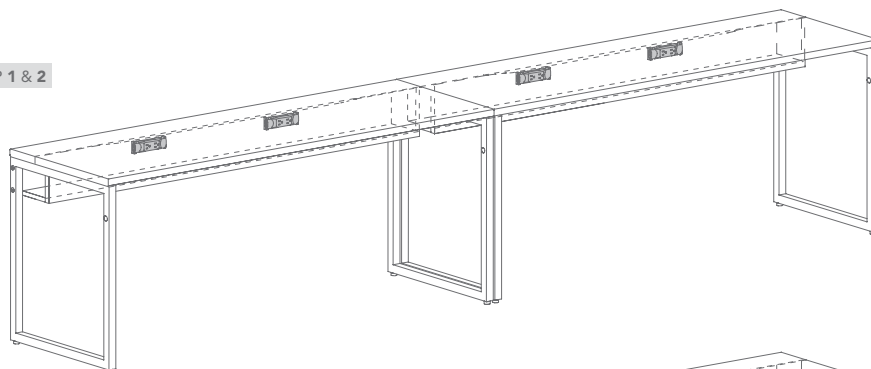

STEP 3

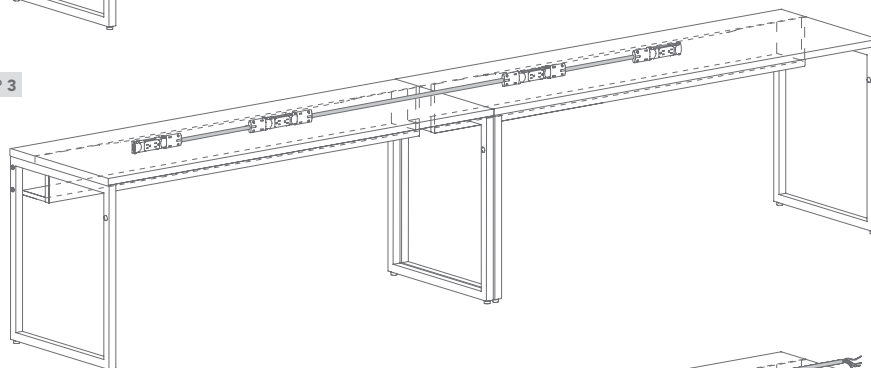

STEP 4

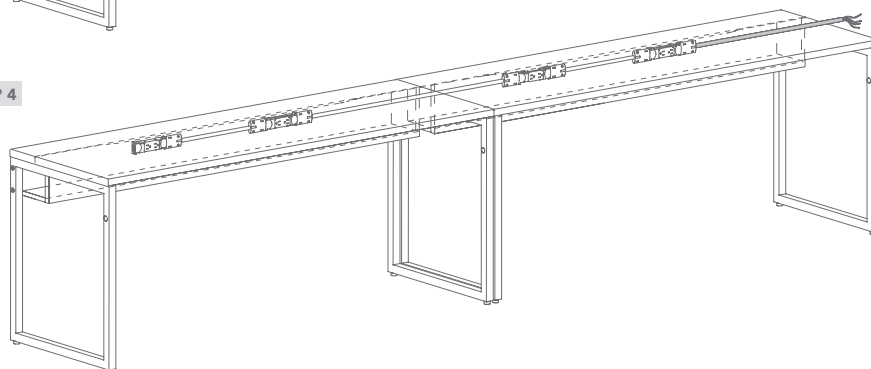

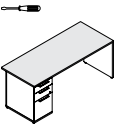
	W x D x H (*)	W x D x H (mm)	Code	All Laminate (\$)	HPL Surfaces (\$)
<b>TEACHER'S DESKS</b>					
<b>Left single pedestal desks</b>	<i>1 pedestal on left with lock. 2 box drawers and 1 file drawer with suspension bar. Lock controls all drawers. Pencil tray. Recessed half-height modesty panel.</i>				
	72 x 30 x 29	1800 x 750 x 735	E___-UF3072S	2,378	2,668
	60 x 30 x 29	1500 x 750 x 735	E___-UF3060S	2,337	2,570
	48 x 30 x 29	1200 x 750 x 735	E___-UF3048S	2,291	2,484
	<b>Specify the surface type (1, 2). Specify the handle code (L, Q, V). Specify the accent color (A, S).</b>				

Packaged in 2 boxes.

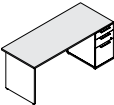
<b>Right single pedestal desks</b>	<i>1 pedestal on right with lock. 2 box drawers and 1 file drawer with suspension bar. Lock controls all drawers. Pencil tray. Recessed half-height modesty panel.</i>				
	72 x 30 x 29	1800 x 750 x 735	E___-S3072UF	2,378	2,668
	60 x 30 x 29	1500 x 750 x 735	E___-S3060UF	2,337	2,570
	48 x 30 x 29	1200 x 750 x 735	E___-S3048UF	2,291	2,484
	<b>Specify the surface type (1, 2). Specify the handle code (L, Q, V). Specify the accent color (A, S).</b>				

Packaged in 2 boxes.

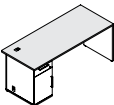
<b>Left single pedestal desks</b>	<i>1 pedestal on left with lock. 1 box drawer and 1 CPU storage with door and ventilation grid. Lock controls drawer and CPU storage door. Grommet on desk surface and on sides of CPU storage. Pencil tray. Recessed half-height modesty panel. CPU storage space: 14" W x 24 1/4" D x 21 1/2" H (356 x 617 x 544 mm).</i>				
	72 x 30 x 29	1800 x 750 x 735	E___-UC3072S	2,075	2,352
	60 x 30 x 29	1500 x 750 x 735	E___-UC3060S	2,030	2,266
	48 x 30 x 29	1200 x 750 x 735	E___-UC3048S	1,988	2,172
	<b>Specify the surface type (1, 2). Specify the handle code (L, Q, V). Specify the accent color (A, S).</b>				

Packaged in 2 boxes.

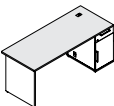
<b>Right single pedestal desks</b>	<i>1 pedestal on right with lock. 1 box drawer and 1 CPU storage with door and ventilation grid. Lock controls drawer and CPU storage door. Grommet on desk surface and on sides of CPU storage. Pencil tray. Recessed half-height modesty panel. CPU storage space: 14" W x 24 1/4" D x 21 1/2" H (356 x 617 x 544 mm).</i>				
	72 x 30 x 29	1800 x 750 x 735	E___-S3072UC	2,075	2,352
	60 x 30 x 29	1500 x 750 x 735	E___-S3060UC	2,030	2,266
	48 x 30 x 29	1200 x 750 x 735	E___-S3048UC	1,988	2,172
	<b>Specify the surface type (1, 2). Specify the handle code (L, Q, V). Specify the accent color (A, S).</b>				

Packaged in 2 boxes.

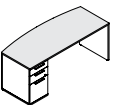
<b>Left single pedestal bow front desks</b>	<i>1 pedestal on left with lock. 2 box drawers and 1 file drawer with suspension bar. Lock controls all drawers. Pencil tray. Recessed half-height modesty panel.</i>				
	72 x 30 x 29	1800 x 750 x 735	E___-UF3072SA	2,449	2,787
	60 x 30 x 29	1500 x 750 x 735	E___-UF3060SA	2,406	2,683
	48 x 30 x 29	1200 x 750 x 735	E___-UF3048SA	2,352	2,581
	<b>Specify the surface type (1, 2). Specify the handle code (L, Q, V). Specify the accent color (A, S).</b>				

Packaged in 2 boxes.

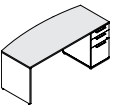
<b>Right single pedestal bow front desks</b>	<i>1 pedestal on right with lock. 2 box drawers and 1 file drawer with suspension bar. Lock controls all drawers. Pencil tray. Recessed half-height modesty panel.</i>				
	72 x 30 x 29	1800 x 750 x 735	E___-S3072UFA	2,449	2,787
	60 x 30 x 29	1500 x 750 x 735	E___-S3060UFA	2,406	2,683
	48 x 30 x 29	1200 x 750 x 735	E___-S3048UFA	2,352	2,581
	<b>Specify the surface type (1, 2). Specify the handle code (L, Q, V). Specify the accent color (A, S).</b>				

Packaged in 2 boxes.

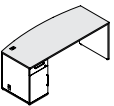
<b>Left single pedestal bow front desks</b>	<i>1 pedestal on left with lock. 1 box drawer and 1 CPU storage with door and ventilation grid. Lock controls drawer and CPU storage door. Grommet on desk surface and on sides of CPU storage. Pencil tray. Recessed half-height modesty panel. CPU storage space: 14" W x 24 1/4" D x 21 1/2" H (356 x 617 x 544 mm).</i>				
	72 x 30 x 29	1800 x 750 x 735	E___-UC3072SA	2,109	2,449
	60 x 30 x 29	1500 x 750 x 735	E___-UC3060SA	2,059	2,337
	48 x 30 x 29	1200 x 750 x 735	E___-UC3048SA	2,005	2,230
	<b>Specify the surface type (1, 2). Specify the handle code (L, Q, V). Specify the accent color (A, S).</b>				

Packaged in 2 boxes.

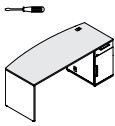
	W x D x H (*)	W x D x H (mm)	Code	All Laminate (\$)	HPL Surfaces (\$)
<b>Right single pedestal bow front desks</b>					
	<i>1 pedestal on right with lock. 1 box drawer and 1 CPU storage with door and ventilation grid. Lock controls drawer and CPU storage door. Grommet on desk surface and on sides of CPU storage. Pencil tray. Recessed half-height modesty panel. CPU storage space: 14" W x 24 1/4" D x 21 1/2" H (356 x 617 x 544 mm).</i>				
	72 x 30 x 29	1800 x 750 x 735	E___-S3072UCA	2,109	2,449
	60 x 30 x 29	1500 x 750 x 735	E___-S3060UCA	2,059	2,337
	48 x 30 x 29	1200 x 750 x 735	E___-S3048UCA	2,005	2,230
	<b>Specify the surface type (1, 2). Specify the handle code (L, Q, V). Specify the accent color (A, S).</b>				

Packaged in 2 boxes.

<b>D-SHAPED TEACHER'S DESKS</b>					
<b>Left single pedestal D-shaped desks</b>	<i>1 pedestal on left with lock. 2 box drawers and 1 file drawer with suspension bar. Lock controls all drawers. Pencil tray. Recessed half-height modesty panel. 2 steel legs.</i>				
	72 x 30 x 29	1800 x 750 x 735	E___-UF3072D	2,737	3,014
	60 x 30 x 29	1500 x 750 x 735	E___-UF3060D	2,701	2,938
	<b>Specify the surface type (1, 2). Specify the handle code (L, Q, V). Specify the accent color (A, S).</b>				

Specify the leg selection at the end of the product code (Q, V).  
Packaged in 3 boxes.

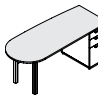
<b>Right single pedestal D-shaped desks</b>	<i>1 pedestal on right with lock. 2 box drawers and 1 file drawer with suspension bar. Lock controls all drawers. Pencil tray. Recessed half-height modesty panel. 2 steel legs.</i>				
	72 x 30 x 29	1800 x 750 x 735	E___-3072UFD	2,737	3,014
	60 x 30 x 29	1500 x 750 x 735	E___-3060UFD	2,701	2,938
	<b>Specify the surface type (1, 2). Specify the handle code (L, Q, V). Specify the accent color (A, S).</b>				

Specify the leg selection at the end of the product code (Q, V).  
Packaged in 3 boxes.

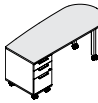
<b>Left single pedestal D-shaped mobile desks</b>	<i>1 pedestal on left with lock. 2 box drawers and 1 file drawer with suspension bar. Lock controls all drawers. Pencil tray. Recessed half-height modesty panel. 2 steel legs. 6 swivel casters, 4 with brakes.</i>				
	72 x 30 x 29	1800 x 750 x 735	E___-MUF3072D	2,841	3,120
	60 x 30 x 29	1500 x 750 x 735	E___-MUF3060D	2,806	3,041
	<b>Specify the surface type (1, 2). Specify the handle code (L, Q, V). Specify the accent color (A, S).</b>				

Specify the leg selection at the end of the product code (Q, V).  
Packaged in 3 boxes.

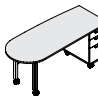
<b>Right single pedestal D-shaped mobile desks</b>	<i>1 pedestal on right with lock. 2 box drawers and 1 file drawer with suspension bar. Lock controls all drawers. Pencil tray. Recessed half-height modesty panel. 2 steel legs. 6 swivel casters, 4 with brakes.</i>				
	72 x 30 x 29	1800 x 750 x 735	E___-M3072UFD	2,841	3,120
	60 x 30 x 29	1500 x 750 x 735	E___-M3060UFD	2,806	3,041
	<b>Specify the surface type (1, 2). Specify the handle code (L, Q, V). Specify the accent color (A, S).</b>				

Specify the leg selection at the end of the product code (Q, V).  
Packaged in 3 boxes.

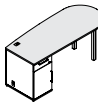
<b>Left single pedestal D-shaped desks</b>	<i>1 pedestal on left with lock. 1 box drawer and 1 CPU storage with door and ventilation grid. Lock controls drawer and CPU storage door. Grommet on desk surface and on sides of CPU storage. Pencil tray. Recessed half-height modesty panel. 2 steel legs. CPU storage space: 14" W x 24 1/4" D x 21 1/2" H (356 x 617 x 544 mm).</i>				
	72 x 30 x 29	1800 x 750 x 735	E___-UC3072D	2,668	2,946
	60 x 30 x 29	1500 x 750 x 735	E___-UC3060D	2,631	2,867
	<b>Specify the surface type (1, 2). Specify the handle code (L, Q, V). Specify the accent color (A, S).</b>				

Specify the leg selection at the end of the product code (Q, V).  
Packaged in 3 boxes.

W x D x H (")	W x D x H (mm)	Code	All Laminate (\$)	HPL Surfaces (\$)
72 x 30 x 29	1800 x 750 x 735	E___-3072UCD	2,668	2,946
60 x 30 x 29	1500 x 750 x 735	E___-3060UCD	2,631	2,867

**Right single pedestal D-shaped desks**  
 1 pedestal on right with lock. 1 box drawer and 1 CPU storage with door and ventilation grid. Lock controls drawer and CPU storage door. Grommet on desk surface and on sides of CPU storage. Pencil tray. Recessed half-height modesty panel. 2 steel legs. CPU storage space: 14" W x 24 1/4" D x 21 1/2" H (356 x 617 x 544 mm).

Specify the leg selection at the end of the product code (Q, V).  
 Packaged in 3 boxes.

W x D x H (")	W x D x H (mm)	Code	All Laminate (\$)	HPL Surfaces (\$)
72 x 30 x 29	1800 x 750 x 735	E___-MUC3072D	2,776	3,049
60 x 30 x 29	1500 x 750 x 735	E___-MUC3060D	2,737	2,973

**Left single pedestal D-shaped mobile desks**  
 1 pedestal on left with lock. 1 box drawer and 1 CPU storage with door and ventilation grid. Lock controls drawer and CPU storage door. Swivel wire supports. Grommet on desk surface and on sides of CPU storage. Pencil tray. Recessed half-height modesty panel. 2 steel legs. 6 swivel casters, 4 with brakes. CPU storage space: 14" W x 24 1/4" D x 18 3/8" H (356 x 617 x 467 mm).

Specify the leg selection at the end of the product code (Q, V).  
 Packaged in 3 boxes.

W x D x H (")	W x D x H (mm)	Code	All Laminate (\$)	HPL Surfaces (\$)
72 x 30 x 29	1800 x 750 x 735	E___-M3072UCD	2,776	3,049
60 x 30 x 29	1500 x 750 x 735	E___-M3060UCD	2,737	2,973

**Right single pedestal D-shaped mobile desks**  
 1 pedestal on right with lock. 1 box drawer and 1 CPU storage with door and ventilation grid. Lock controls drawer and CPU storage door. Swivel wire supports. Grommet on desk surface and on sides of CPU storage. Pencil tray. Recessed half-height modesty panel. 2 steel legs. 6 swivel casters, 4 with brakes. CPU storage space: 14" W x 24 1/4" D x 18 3/8" H (356 x 617 x 467 mm).

Specify the leg selection at the end of the product code (Q, V).  
 Packaged in 3 boxes.

**P-SHAPED TEACHER'S DESKS**

W x D x H (")	W x D x H (mm)	Code	All Laminate (\$)	HPL Surfaces (\$)
72 x 36 x 29	1800 x 900 x 735	E___-UF3672P	2,867	3,207
66 x 36 x 29	1650 x 900 x 735	E___-UF3666P	2,850	3,130

**Left single pedestal P-shaped desks**  
 1 pedestal on left with lock. 2 box drawers and 1 file drawer with suspension bar. Lock controls all drawers. Pencil tray. Recessed half-height modesty panel. 2 steel legs.

Specify the surface type (1, 2). Specify the handle code (L, Q, V).  
 Specify the accent color (A, S).

W x D x H (")	W x D x H (mm)	Code	All Laminate (\$)	HPL Surfaces (\$)
72 x 36 x 29	1800 x 900 x 735	E___-3672UFP	2,867	3,207
66 x 36 x 29	1650 x 900 x 735	E___-3666UFP	2,850	3,130

**Right single pedestal P-shaped desks**  
 1 pedestal on right with lock. 2 box drawers and 1 file drawer with suspension bar. Lock controls all drawers. Pencil tray. Recessed half-height modesty panel. 2 steel legs.

Specify the surface type (1, 2). Specify the handle code (L, Q, V).  
 Specify the accent color (A, S).

W x D x H (")	W x D x H (mm)	Code	All Laminate (\$)	HPL Surfaces (\$)
72 x 36 x 29	1800 x 900 x 735	E___-MUF3672P	2,973	3,313
66 x 36 x 29	1650 x 900 x 735	E___-MUF3666P	2,955	3,235

**Left single pedestal P-shaped mobile desks**  
 1 pedestal on left with lock. 2 box drawers and 1 file drawer with suspension bar. Lock controls all drawers. Pencil tray. Recessed half-height modesty panel. 2 steel legs. 6 swivel casters, 4 with brakes.

Specify the leg selection at the end of the product code (Q, V).  
 Packaged in 3 boxes.

W x D x H (")	W x D x H (mm)	Code	All Laminate (\$)	HPL Surfaces (\$)
72 x 36 x 29	1800 x 900 x 735	E___-M3672UFP	2,973	3,313
66 x 36 x 29	1650 x 900 x 735	E___-M3666UFP	2,955	3,235

**Right single pedestal P-shaped mobile desks**  
 1 pedestal on right with lock. 2 box drawers and 1 file drawer with suspension bar. Lock controls all drawers. Pencil tray. Recessed half-height modesty panel. 2 steel legs. 6 swivel casters, 4 with brakes.

Specify the leg selection at the end of the product code (Q, V).  
 Packaged in 3 boxes.

W x D x H (")	W x D x H (mm)	Code	All Laminate (\$)	HPL Surfaces (\$)
72 x 36 x 29	1800 x 900 x 735	E___-UC3672P	2,390	2,729
66 x 36 x 29	1650 x 900 x 735	E___-UC3666P	2,352	2,631

**Left single pedestal P-shaped desks**  
 1 pedestal on left with lock. 1 box drawer and 1 CPU storage with door and ventilation grid. Lock controls drawer and CPU storage door. Grommet on desk surface and on sides of CPU storage. Pencil tray. Recessed half-height modesty panel. 2 steel legs. CPU storage space: 14" W x 24 1/4" D x 21 1/2" H (356 x 617 x 544 mm).

Specify the leg selection at the end of the product code (Q, V).  
 Packaged in 3 boxes.

W x D x H (")	W x D x H (mm)	Code	All Laminate (\$)	HPL Surfaces (\$)
72 x 36 x 29	1800 x 900 x 735	E___-3672UCP	2,390	2,729
66 x 36 x 29	1650 x 900 x 735	E___-3666UCP	2,352	2,631

**Right single pedestal P-shaped desks**  
 1 pedestal on right with lock. 1 box drawer and 1 CPU storage with door and ventilation grid. Lock controls drawer and CPU storage door. Grommet on desk surface and on sides of CPU storage. Pencil tray. Recessed half-height modesty panel. 2 steel legs. CPU storage space: 14" W x 24 1/4" D x 21 1/2" H (356 x 617 x 544 mm).

Specify the leg selection at the end of the product code (Q, V).  
 Packaged in 3 boxes.

W x D x H (")	W x D x H (mm)	Code	All Laminate (\$)	HPL Surfaces (\$)
72 x 36 x 29	1800 x 900 x 735	E___-MUC3672P	2,493	2,834
66 x 36 x 29	1650 x 900 x 735	E___-MUC3666P	2,456	2,737

**Left single pedestal P-shaped mobile desks**  
 1 pedestal on left with lock. 1 box drawer and 1 CPU storage with door and ventilation grid. Lock controls drawer and CPU storage door. Swivel wire supports. Grommet on desk surface and on sides of CPU storage. Pencil tray. Recessed half-height modesty panel. 2 steel legs. 6 swivel casters, 4 with brakes. CPU storage space: 14" W x 24 1/4" D x 18 3/8" H (356 x 617 x 467 mm).

Specify the leg selection at the end of the product code (Q, V).  
 Packaged in 3 boxes.

W x D x H (")	W x D x H (mm)	Code	All Laminate (\$)	HPL Surfaces (\$)
72 x 36 x 29	1800 x 900 x 735	E___-M3672UCP	2,493	2,834
66 x 36 x 29	1650 x 900 x 735	E___-M3666UCP	2,456	2,737

**Right single pedestal P-shaped mobile desks**  
 1 pedestal on right with lock. 1 box drawer and 1 CPU storage with door and ventilation grid. Lock controls drawer and CPU storage door. Swivel wire supports. Grommet on desk surface and on sides of CPU storage. Pencil tray. Recessed half-height modesty panel. 2 steel legs. 6 swivel casters, 4 with brakes. CPU storage space: 14" W x 24 1/4" D x 18 3/8" H (356 x 617 x 467 mm).

Specify the leg selection at the end of the product code (Q, V).  
 Packaged in 3 boxes.

W x D x H (")	W x D x H (mm)	Code	All Laminate (\$)	HPL Surfaces (\$)
72 x 30 x 42	1800 x 750 x 1063	E___-LUF3072	3,049	3,391
66 x 30 x 42	1650 x 750 x 1063	E___-LUF3066	3,014	3,251

**Left lectern-desks single pedestal**  
 11 7/8" H (300 mm) storage opening under lectern surface. Pedestal on left with lock. 2 box drawers and 1 file drawer with suspension bar. Lock controls all drawers. Pencil tray. Recessed half-height modesty panel. 2 steel legs.

Specify the surface type (1, 2). Specify the handle code (L, Q, V).  
 Specify the accent color (A, S).

— = ASSEMBLY REQUIRED

	W x D x H (*)	W x D x H (mm)	Code	All Laminate (\$)	HPL Surfaces (\$)
<b>Right lectern-desks single pedestal</b>	<i>11 7/8" H (300 mm) storage opening under lectern surface. Pedestal on right with lock. 2 box drawers and 1 file drawer with suspension bar. Lock controls all drawers. Pencil tray. Recessed half-height modesty panel. 2 steel legs.</i>				
	72 x 30 x 42	1800 x 750 x 1063	E___-3072LUF_	3,049	3,391
	66 x 30 x 42	1650 x 750 x 1063	E___-3066LUF_	3,014	3,251

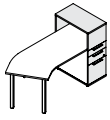

Specify the leg selection at the end of the product code (Q, V).  
Packaged in 3 boxes.

<b>Left lectern-desks single pedestal, mobile</b>	<i>11 7/8" H (300 mm) storage opening under lectern surface. Pedestal on left with lock. 2 box drawers and 1 file drawer with suspension bar. Lock controls all drawers. Pencil tray. Recessed half-height modesty panel. 2 steel legs. 6 swivel casters, 4 with brakes.</i>				
	72 x 30 x 42	1800 x 750 x 1063	E___-MLUF3072_	3,156	3,496
	66 x 30 x 42	1650 x 750 x 1063	E___-MLUF3066_	3,120	3,355

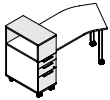

Specify the leg selection at the end of the product code (Q, V).  
Packaged in 3 boxes.

<b>Right lectern-desks single pedestal, mobile</b>	<i>11 7/8" H (300 mm) storage opening under lectern surface. Pedestal on right with lock. 2 box drawers and 1 file drawer with suspension bar. Lock controls all drawers. Pencil tray. Recessed half-height modesty panel. 2 steel legs. 6 swivel casters, 4 with brakes.</i>				
	72 x 30 x 42	1800 x 750 x 1063	E___-M3072LUF_	3,156	3,496
	66 x 30 x 42	1650 x 750 x 1063	E___-M3066LUF_	3,120	3,355



Specify the leg selection at the end of the product code (Q, V).  
Packaged in 3 boxes.

<b>Left lectern-desks single pedestal</b>	<i>11 7/8" H (300 mm) storage opening under lectern surface. 1 pedestal on left with lock. 1 box drawer and 1 CPU storage with door and ventilation grid. Lock controls drawer and CPU storage door. Grommet on lectern surface, desk surface and on sides of CPU storage. Pencil tray. Recessed half-height modesty panel. 2 steel legs. CPU storage space: 14" W x 24 1/4" D x 21 1/2" H (356 x 617 x 544 mm).</i>				
	72 x 30 x 42	1800 x 750 x 1063	E___-LUC3072_	2,781	3,165
	66 x 30 x 42	1650 x 750 x 1063	E___-LUC3066_	2,747	2,992

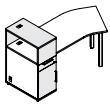

Specify the leg selection at the end of the product code (Q, V).  
Packaged in 3 boxes.

<b>Right lectern-desks single pedestal</b>	<i>11 7/8" H (300 mm) storage opening under lectern surface. 1 pedestal on right with lock. Storage with door and ventilation grid. Lock controls drawer and CPU storage door. Grommet on lectern surface, desk surface and on sides of CPU storage. Pencil tray. Recessed half-height modesty panel. 2 steel legs. CPU storage space: 14" W x 24 1/4" D x 21 1/2" H (356 x 617 x 544 mm).</i>				
	72 x 30 x 42	1800 x 750 x 1063	E___-3072LUC_	2,781	3,165
	66 x 30 x 42	1650 x 750 x 1063	E___-3066LUC_	2,747	2,992

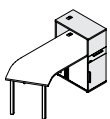

Specify the leg selection at the end of the product code (Q, V).  
Packaged in 3 boxes.

	W x D x H (*)	W x D x H (mm)	Code	All Laminate (\$)	HPL Surfaces (\$)
<b>Left lectern-desks single pedestal, mobile</b>	<i>11 7/8" H (300 mm) storage opening under lectern surface. 1 pedestal on left with lock. 1 box drawer and 1 CPU storage with door and ventilation grid. Lock controls drawer and CPU storage door. Swivel wire supports. Grommet on lectern surface, desk surface and on sides of CPU storage. Pencil tray. Recessed half-height modesty panel. 2 steel legs. 6 swivel casters, 4 with brakes. CPU storage space: 14" W x 24 1/4" D x 18 3/8" H (356 x 617 x 467 mm).</i>				
	72 x 30 x 42	1800 x 750 x 1063	E___-MLUC3072_	2,886	3,268
	66 x 30 x 42	1650 x 750 x 1063	E___-MLUC3066_	2,850	3,093

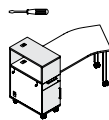

Specify the leg selection at the end of the product code (Q, V).  
Packaged in 3 boxes.

<b>Right lectern-desks single pedestal, mobile</b>	<i>11 7/8" H (300 mm) storage opening under lectern surface. 1 pedestal on right with lock. 1 box drawer and 1 CPU storage with door and ventilation grid. Lock controls drawer and CPU storage door. Swivel wire supports. Grommet on lectern surface, desk surface and on sides of CPU storage. Pencil tray. Recessed half-height modesty panel. 2 steel legs. 6 swivel casters, 4 with brakes. CPU storage space: 14" W x 24 1/4" D x 18 3/8" H (356 x 617 x 467 mm).</i>				
	72 x 30 x 42	1800 x 750 x 1063	E___-M3072LUC_	2,886	3,268
	66 x 30 x 42	1650 x 750 x 1063	E___-M3066LUC_	2,850	3,093



Specify the leg selection at the end of the product code (Q, V).  
Packaged in 3 boxes.

**CARRELS – 29" H WORK SURFACE**

<i>Wire opening on top. 3/4 height modesty panel. Levelers with 1 1/2" (38 mm) height adjustment.</i>					
<b>Individual single-sided carrels, 33" H</b>					
<b>Starter</b>					
37 x 34 1/2 x 33	925 x 869 x 834	E_NN-CS343733	1,002	1,133	
<b>Add-on</b>					
<i>Wire access on side panel.</i>					
36 x 34 1/2 x 33	900 x 869 x 834	E_NN-CA343633	813	941	

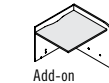
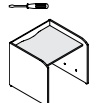

<i>Wire opening on top. 3/4 height modesty panel. Levelers with 1 1/2" (38 mm) height adjustment.</i>					
<b>Shared single-sided carrels, 33" H</b>					
<b>Starter</b>					
73 x 34 1/2 x 33	1825 x 869 x 834	E_NN-CS347333	1,278	1,542	
<b>Add-on</b>					
<i>Wire access on side panel.</i>					
72 x 34 1/2 x 33	1800 x 869 x 834	E_NN-CA347233	1,090	1,351	

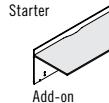
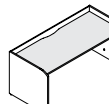

<i>Wire opening on top. 3/4 height modesty panel. Levelers with 1 1/2" (38 mm) height adjustment. 8" (200 mm) deep fixed accessory shelf. Clearance 15 5/8" H (390 mm).</i>					
<b>Individual single-sided carrels, 53" H</b>					
<b>Starter</b>					
37 x 34 1/2 x 53	925 x 869 x 1342	E_NN-CS343753	1,291	1,425	
<b>Add-on</b>					
<i>Wire access on side panel.</i>					
36 x 34 1/2 x 53	900 x 869 x 1342	E_NN-CA343653	1,046	1,177	

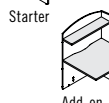
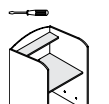

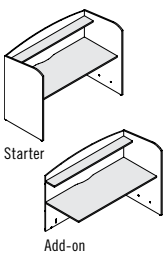
	W x D x H (")	W x D x H (mm)	Code	All Laminate (\$)	HPL Surfaces (\$)
<b>Shared single-sided carrels, 53" H</b> 	<i>Wire opening on top. 3/4 height modesty panel. Levelers with 1 1/2" (38 mm) height adjustment. 8" (200 mm) deep fixed accessory shelf. Clearance 15 3/8" H (390 mm).</i>				
	<b>Starter</b>				
	73 x 34 1/2 x 53	1825 x 869 x 1342	<b>E_NN-CS347353</b>	<b>1,714</b>	<b>1,988</b>
<b>Add-on</b> <i>Wire access on side panel.</i>	<b>Starter</b>				
	72 x 34 1/2 x 53	1800 x 869 x 1342	<b>E_NN-CA347253</b>	<b>1,465</b>	<b>1,736</b>
<b>Specify the surface type (1, 2).</b>					

Packaged in 2 boxes.

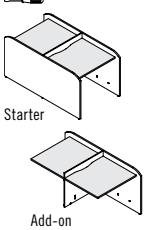
	W x D x H (")	W x D x H (mm)	Code	All Laminate (\$)	HPL Surfaces (\$)
<b>Individual double-sided carrels, 33" H</b> 	<i>Wire opening on top. 3/4 height modesty panel. Levelers with 1 1/2" (38 mm) height adjustment.</i>				
	<b>Starter</b>				
	37 x 67 1/2 x 33	925 x 1716 x 834	<b>E_NN-CS673733</b>	<b>1,444</b>	<b>1,587</b>
<b>Add-on</b> <i>Wire access on side panel.</i>	<b>Starter</b>				
	36 x 67 1/2 x 33	900 x 1716 x 834	<b>E_NN-CA673633</b>	<b>1,090</b>	<b>1,219</b>
<b>Specify the surface type (1, 2).</b>					

Starter:  
Packaged in 2 boxes.

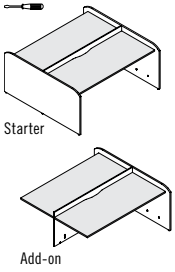
	W x D x H (")	W x D x H (mm)	Code	All Laminate (\$)	HPL Surfaces (\$)
<b>Shared double-sided carrels, 33" H</b> 	<i>Wire opening on top. 3/4 height modesty panel. Levelers with 1 1/2" (38 mm) height adjustment.</i>				
	<b>Starter</b>				
	73 x 67 1/2 x 33	1825 x 1716 x 834	<b>E_NN-CS677333</b>	<b>1,925</b>	<b>2,194</b>
<b>Add-on</b> <i>Wire access on side panel.</i>	<b>Starter</b>				
	72 x 67 1/2 x 33	1800 x 1716 x 834	<b>E_NN-CA677233</b>	<b>1,672</b>	<b>1,945</b>
<b>Specify the surface type (1, 2).</b>					

Packaged in 2 boxes.

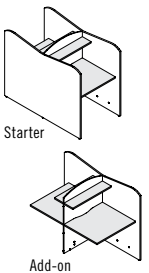
	W x D x H (")	W x D x H (mm)	Code	All Laminate (\$)	HPL Surfaces (\$)
<b>Individual double-sided carrels, 53" H</b> 	<i>Wire opening on top. 3/4 height modesty panel. Levelers with 1 1/2" (38 mm) height adjustment. 8" (200 mm) deep fixed accessory shelf. Clearance 15 3/8" H (390 mm).</i>				
	<b>Starter</b>				
	37 x 67 1/2 x 53	925 x 1716 x 1342	<b>E_NN-CS673753</b>	<b>2,016</b>	<b>2,144</b>
<b>Add-on</b> <i>Wire access on side panel.</i>	<b>Starter</b>				
	36 x 67 1/2 x 53	900 x 1716 x 1342	<b>E_NN-CA673653</b>	<b>1,642</b>	<b>1,768</b>
<b>Specify the surface type (1, 2).</b>					

Packaged in 2 boxes.

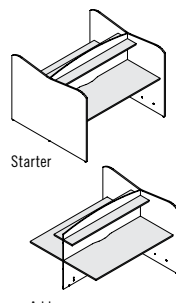
	W x D x H (")	W x D x H (mm)	Code	All Laminate (\$)	HPL Surfaces (\$)
<b>Shared double-sided carrels, 53" H</b> 	<i>Wire opening on top. 3/4 height modesty panel. Levelers with 1 1/2" (38 mm) height adjustment. 8" (200 mm) deep fixed accessory shelf. Clearance 15 3/8" H (390 mm).</i>				
	<b>Starter</b>				
	73 x 67 1/2 x 53	1825 x 1716 x 1342	<b>E_NN-CS677353</b>	<b>2,623</b>	<b>2,886</b>
<b>Add-on</b> <i>Wire access on side panel.</i>	<b>Starter</b>				
	72 x 67 1/2 x 53	1800 x 1716 x 1342	<b>E_NN-CA677253</b>	<b>2,251</b>	<b>2,519</b>
<b>Specify the surface type (1, 2).</b>					

Packaged in 2 boxes.

	W x D x H (")	W x D x H (mm)	Code	All Laminate (\$)	HPL Surfaces (\$)
<b>ADA bracket kit</b> 	<i>Kit includes metal brackets and hardware to raise the surface of a carrel to ADA height (from 29" to 32" H/735 to 813 mm). Package of 6 brackets. Order one package per carrel.</i>				
	1 x 1 x 4	25 x 25 x 104	<b>ENNN-CADAKIT</b>	<b>173</b>	-

**COMPUTER CARRELS – 29" H WORK SURFACE**

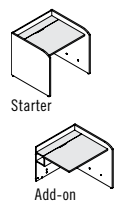
	W x D x H (")	W x D x H (mm)	Code	All Laminate (\$)	HPL Surfaces (\$)
<b>Individual single-sided carrels, 33" H</b> 	<i>Wire management raceway accessible by a lockable cover on hinges. Grommet on back. 3/4 height modesty panel. Levelers with 1 1/2" (38 mm) height adjustment.</i>				
	<b>Starter</b>				
	37 x 67 1/2 x 33	925 x 869 x 834	<b>E_NN-CCS343733</b>	<b>1,444</b>	<b>1,578</b>
<b>Add-on</b> <i>Wire access on side panel.</i>	<b>Starter</b>				
	36 x 34 1/2 x 33	900 x 869 x 834	<b>E_NN-CCA343633</b>	<b>1,219</b>	<b>1,358</b>
<b>Specify the surface type (1, 2).</b>					

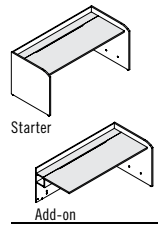
	W x D x H (")	W x D x H (mm)	Code	All Laminate (\$)	HPL Surfaces (\$)
<b>Shared single-sided carrels, 33" H</b> 	<i>Wire management raceway accessible by a lockable cover on hinges. Grommet on back. 3/4 height modesty panel. Levelers with 1 1/2" (38 mm) height adjustment.</i>				
	<b>Starter</b>				
	73 x 34 1/2 x 33	1825 x 869 x 834	<b>E_NN-CCS347333</b>	<b>1,768</b>	<b>2,035</b>
<b>Add-on</b> <i>Wire access on side panel.</i>	<b>Starter</b>				
	72 x 34 1/2 x 33	1800 x 869 x 834	<b>E_NN-CCA347233</b>	<b>1,542</b>	<b>1,813</b>
<b>Specify the surface type (1, 2).</b>					

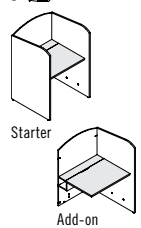
	W x D x H (")	W x D x H (mm)	Code	All Laminate (\$)	HPL Surfaces (\$)
<b>Individual single-sided carrels, 53" H</b> 	<i>Wire management raceway accessible by a lockable cover on hinges. Grommet on back. 3/4 height modesty panel. Levelers with 1 1/2" (38 mm) height adjustment.</i>				
	<b>Starter</b>				
	37 x 34 1/2 x 53	925 x 869 x 1342	<b>E_NN-CCS343753</b>	<b>1,736</b>	<b>1,866</b>
<b>Add-on</b> <i>Wire access on side panel.</i>	<b>Starter</b>				
	36 x 34 1/2 x 53	900 x 869 x 1342	<b>E_NN-CCA343653</b>	<b>1,444</b>	<b>1,587</b>
<b>Specify the surface type (1, 2).</b>					

	W x D x H (*)	W x D x H (mm)	Code	All Laminate (\$)	HPL Surfaces (\$)
<b>Shared single-sided carrels, 53" H</b>	<i>Wire management raceway accessible by a lockable cover on hinges. Grommet on back. ¾ height modesty panel. Levelers with 1½" (38 mm) height adjustment.</i>				
<b>Starter</b>	73 x 34½ x 53	1825 x 869 x 1342	<b>E_NN-CCS347353</b>	<b>2,128</b>	<b>2,398</b>
<b>Add-on</b>	<i>Wire access on side panel.</i>				
	72 x 34½ x 53	1800 x 869 x 1342	<b>E_NN-CCA347253</b>	<b>1,848</b>	<b>2,118</b>
	<b>Specify the surface type (1, 2).</b>				

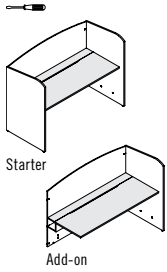

Packaged in 2 boxes.

	W x D x H (*)	W x D x H (mm)	Code	All Laminate (\$)	HPL Surfaces (\$)
<b>Individual double-sided carrels, 33" H</b>	<i>Wire management raceway accessible by a lockable cover on hinges. Grommet on back. ¾ height modesty panel. Levelers with 1½" (38 mm) height adjustment.</i>				
<b>Starter</b>	37 x 67½ x 33	925 x 1716 x 834	<b>E_NN-CCS673733</b>	<b>1,873</b>	<b>2,005</b>
<b>Add-on</b>	<i>Wire access on side panel.</i>				
	36 x 67½ x 33	900 x 1716 x 834	<b>E_NN-CCA673633</b>	<b>1,563</b>	<b>1,692</b>
	<b>Specify the surface type (1, 2).</b>				

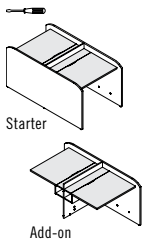

Starter:  
Packaged in 2 boxes.

	W x D x H (*)	W x D x H (mm)	Code	All Laminate (\$)	HPL Surfaces (\$)
<b>Shared double-sided carrels, 33" H</b>	<i>Wire management raceway accessible by a lockable cover on hinges. Grommet on back. ¾ height modesty panel. Levelers with 1½" (38 mm) height adjustment.</i>				
<b>Starter</b>	73 x 67½ x 33	1825 x 1716 x 834	<b>E_NN-CCS677333</b>	<b>2,449</b>	<b>2,708</b>
<b>Add-on</b>	<i>Wire access on side panel.</i>				
	72 x 67½ x 33	1800 x 1716 x 834	<b>E_NN-CCA677233</b>	<b>2,164</b>	<b>2,430</b>
	<b>Specify the surface type (1, 2).</b>				

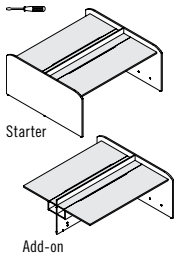

Packaged in 2 boxes.

	W x D x H (*)	W x D x H (mm)	Code	All Laminate (\$)	HPL Surfaces (\$)
<b>Individual double-sided carrels, 53" H</b>	<i>Wire management raceway accessible by a lockable cover on hinges. Grommet on back. ¾ height modesty panel. Levelers with 1½" (38 mm) height adjustment.</i>				
<b>Starter</b>	37 x 67½ x 53	925 x 1716 x 1342	<b>E_NN-CCS673753</b>	<b>2,430</b>	<b>2,565</b>
<b>Add-on</b>	<i>Wire access on side panel.</i>				
	36 x 67½ x 53	900 x 1716 x 1342	<b>E_NN-CCA673653</b>	<b>2,030</b>	<b>2,164</b>
	<b>Specify the surface type (1, 2).</b>				

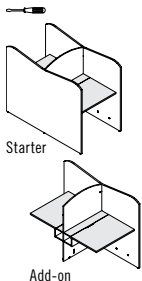

Packaged in 2 boxes.

	W x D x H (*)	W x D x H (mm)	Code	All Laminate (\$)	HPL Surfaces (\$)
<b>Shared double-sided carrels, 53" H</b>	<i>Wire management raceway accessible by a lockable cover on hinges. Grommet on back. ¾ height modesty panel. Levelers with 1½" (38 mm) height adjustment.</i>				
<b>Starter</b>	73 x 67½ x 53	1825 x 1716 x 1342	<b>E_NN-CCS677353</b>	<b>3,137</b>	<b>3,409</b>
<b>Add-on</b>	<i>Wire access on side panel.</i>				
	72 x 67½ x 53	1800 x 1716 x 1342	<b>E_NN-CCA677253</b>	<b>2,737</b>	<b>3,007</b>
	<b>Specify the surface type (1, 2).</b>				

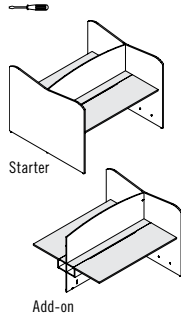

Packaged in 2 boxes.

**COMPUTER CARRELS – 42" H WORK SURFACE**

	W x D x H (*)	W x D x H (mm)	Code	All Laminate (\$)	HPL Surfaces (\$)
<b>Individual single-sided carrels, 53" H</b>	<i>42" H (1063 mm) work surface. Wire management raceway accessible by a lockable cover on hinges. Grommet on back. ¾ height modesty panel. Levelers with 1½" (38 mm) height adjustment.</i>				
<b>Starter</b>	37 x 34½ x 53	925 x 869 x 1342	<b>E_NN-CSS343753</b>	<b>1,714</b>	<b>1,848</b>
<b>Add-on</b>	<i>Wire access on side panel.</i>				
	36 x 34½ x 53	900 x 869 x 1342	<b>E_NN-CSA343653</b>	<b>1,437</b>	<b>1,570</b>
	<b>Specify the surface type (1, 2).</b>				

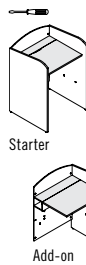

	W x D x H (*)	W x D x H (mm)	Code	All Laminate (\$)	HPL Surfaces (\$)
<b>Shared single-sided carrels, 53" H</b>	<i>42" H (1063 mm) work surface. Wire management raceway accessible by a lockable cover on hinges. Grommet on back. ¾ height modesty panel. Levelers with 1½" (38 mm) height adjustment.</i>				
<b>Starter</b>	73 x 34½ x 53	1825 x 869 x 1342	<b>E_NN-CSS347353</b>	<b>2,101</b>	<b>2,362</b>
<b>Add-on</b>	<i>Wire access on side panel.</i>				
	72 x 34½ x 53	1800 x 869 x 1342	<b>E_NN-CSA347253</b>	<b>1,813</b>	<b>2,083</b>
	<b>Specify the surface type (1, 2).</b>				

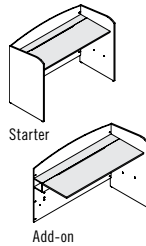

Packaged in 2 boxes.

	W x D x H (*)	W x D x H (mm)	Code	All Laminate (\$)	HPL Surfaces (\$)
<b>Individual double-sided carrels, 53" H</b>	<i>42" H (1063 mm) work surface. Wire management raceway accessible by a lockable cover on hinges. Grommet on back. ¾ height modesty panel. Levelers with 1½" (38 mm) height adjustment.</i>				
<b>Starter</b>	37 x 67½ x 53	925 x 1716 x 1342	<b>E_NN-CSS673753</b>	<b>2,406</b>	<b>2,536</b>
<b>Add-on</b>	<i>Wire access on side panel.</i>				
	36 x 67½ x 53	900 x 1716 x 1342	<b>E_NN-CSA673653</b>	<b>1,998</b>	<b>2,128</b>
	<b>Specify the surface type (1, 2).</b>				

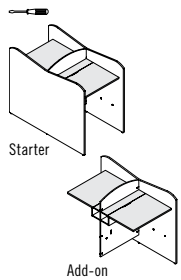

Packaged in 2 boxes.

	W x D x H (")	W x D x H (mm)	Code	All Laminate (\$)	HPL Surfaces (\$)
<b>Shared double-sided carrels, 53" H</b>	<i>42" H (1063 mm) work surface. Wire management raceway accessible by a lockable cover on hinges. Grommet on back. ¼ height modesty panel. Levelers with 1½" (38 mm) height adjustment.</i>				
<b>Starter</b>	73 x 67½ x 53	1825 x 1716 x 1342	<b>E_NN-CSS677353</b>	<b>3,078</b>	<b>3,348</b>
<b>Add-on</b>	<i>Wire access on side panel.</i>				
	72 x 67½ x 53	1800 x 1716 x 1342	<b>E_NN-CSA677253</b>	<b>2,676</b>	<b>2,938</b>

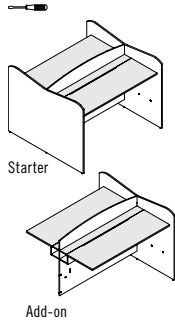

Packaged in 2 boxes.

	W x D x H (")	W x D x H (mm)	Code	All Laminate (\$)	HPL Surfaces (\$)
<b>CPU support for carrels</b>	<i>Laminate CPU support. Compatible with all carrels. Reversible.</i>				
	10 x 26 x 6	255 x 650 x 150	<b>ENNN-SCPU</b>	<b>262</b>	—



**RECTANGULAR TABLES**

	W x D x H (")	W x D x H (mm)	Code	All Laminate (\$)	HPL Surfaces (\$)
<b>Rectangular tables, incremental height adjustment</b>	<i>Metal legs. 1" (25 mm) incremental height adjustment. 6" (150 mm) range. Lowest position is 25" (635 mm) and highest position is 31" (785 mm) high. 6" (150 mm) high modesty panel.</i>				
	72 x 24 x 25-31	1800 x 600 x 635-785	<b>E_N-RCM2472I</b>	<b>1,509</b>	<b>1,736</b>
	66 x 24 x 25-31	1650 x 600 x 635-785	<b>E_N-RCM2466I</b>	<b>1,491</b>	<b>1,700</b>
	60 x 24 x 25-31	1500 x 600 x 635-785	<b>E_N-RCM2460I</b>	<b>1,476</b>	<b>1,664</b>
	54 x 24 x 25-31	1350 x 600 x 635-785	<b>E_N-RCM2454I</b>	<b>1,455</b>	<b>1,629</b>
	48 x 24 x 25-31	1200 x 600 x 635-785	<b>E_N-RCM2448I</b>	<b>1,437</b>	<b>1,595</b>
	42 x 24 x 25-31	1050 x 600 x 635-785	<b>E_N-RCM2442I</b>	<b>1,430</b>	<b>1,563</b>
	36 x 24 x 25-31	900 x 600 x 635-785	<b>E_N-RCM2436I</b>	<b>1,412</b>	<b>1,526</b>
	30 x 24 x 25-31	750 x 600 x 635-785	<b>E_N-RCM2430I</b>	<b>1,395</b>	<b>1,491</b>



	W x D x H (")	W x D x H (mm)	Code	All Laminate (\$)	HPL Surfaces (\$)
<b>Rectangular tables with shelf, incremental height adjustment</b>	<i>Metal legs. 1 fixed shelf. 1" (25 mm) incremental height adjustment. 6" (150 mm) range. Lowest position is 25" (635 mm) and highest position is 31" (785 mm) high. 6" (150 mm) high modesty panel.</i>				
	72 x 24 x 25-31	1800 x 600 x 635-785	<b>E_N-RCM2472SI</b>	<b>1,753</b>	<b>1,978</b>
	66 x 24 x 25-31	1650 x 600 x 635-785	<b>E_N-RCM2466SI</b>	<b>1,727</b>	<b>1,925</b>
	60 x 24 x 25-31	1500 x 600 x 635-785	<b>E_N-RCM2460SI</b>	<b>1,692</b>	<b>1,910</b>
	54 x 24 x 25-31	1350 x 600 x 635-785	<b>E_N-RCM2454SI</b>	<b>1,664</b>	<b>1,841</b>
	48 x 24 x 25-31	1200 x 600 x 635-785	<b>E_N-RCM2448SI</b>	<b>1,642</b>	<b>1,789</b>
	42 x 24 x 25-31	1050 x 600 x 635-785	<b>E_N-RCM2442SI</b>	<b>1,612</b>	<b>1,743</b>
	36 x 24 x 25-31	900 x 600 x 635-785	<b>E_N-RCM2436SI</b>	<b>1,578</b>	<b>1,692</b>
	30 x 24 x 25-31	750 x 600 x 635-785	<b>E_N-RCM2430SI</b>	<b>1,551</b>	<b>1,649</b>



	W x D x H (")	W x D x H (mm)	Code	All Laminate (\$)	HPL Surfaces (\$)
<b>Rectangular tables, fixed height</b>	<i>Metal legs. 6" (150 mm) high modesty panel.</i>				
	72 x 24 x 29	1800 x 600 x 735	<b>E_N-RCM2472J</b>	<b>1,192</b>	<b>1,425</b>
	66 x 24 x 29	1650 x 600 x 735	<b>E_N-RCM2466J</b>	<b>1,177</b>	<b>1,386</b>
	60 x 24 x 29	1500 x 600 x 735	<b>E_N-RCM2460J</b>	<b>1,159</b>	<b>1,351</b>
	54 x 24 x 29	1350 x 600 x 735	<b>E_N-RCM2454J</b>	<b>1,140</b>	<b>1,319</b>
	48 x 24 x 29	1200 x 600 x 735	<b>E_N-RCM2448J</b>	<b>1,133</b>	<b>1,278</b>
	42 x 24 x 29	1050 x 600 x 735	<b>E_N-RCM2442J</b>	<b>1,117</b>	<b>1,246</b>
	36 x 24 x 29	900 x 600 x 735	<b>E_N-RCM2436J</b>	<b>1,098</b>	<b>1,211</b>
	30 x 24 x 29	750 x 600 x 735	<b>E_N-RCM2430J</b>	<b>1,080</b>	<b>1,177</b>

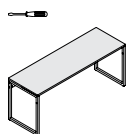

	W x D x H (")	W x D x H (mm)	Code	All Laminate (\$)	HPL Surfaces (\$)
<b>Rectangular tables with shelf, fixed height</b>	<i>Metal legs. 1 fixed shelf. 6" (150 mm) high modesty panel.</i>				
	72 x 24 x 29	1800 x 600 x 735	<b>E_N-RCM2472SJ</b>	<b>1,437</b>	<b>1,664</b>
	66 x 24 x 29	1650 x 600 x 735	<b>E_N-RCM2466SJ</b>	<b>1,412</b>	<b>1,621</b>
	60 x 24 x 29	1500 x 600 x 735	<b>E_N-RCM2460SJ</b>	<b>1,386</b>	<b>1,595</b>
	54 x 24 x 29	1350 x 600 x 735	<b>E_N-RCM2454SJ</b>	<b>1,351</b>	<b>1,526</b>
	48 x 24 x 29	1200 x 600 x 735	<b>E_N-RCM2448SJ</b>	<b>1,325</b>	<b>1,476</b>
	42 x 24 x 29	1050 x 600 x 735	<b>E_N-RCM2442SJ</b>	<b>1,299</b>	<b>1,430</b>
	36 x 24 x 29	900 x 600 x 735	<b>E_N-RCM2436SJ</b>	<b>1,272</b>	<b>1,386</b>
	30 x 24 x 29	750 x 600 x 735	<b>E_N-RCM2430SJ</b>	<b>1,238</b>	<b>1,332</b>

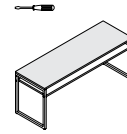

**LAPTOP TABLES**

	W x D x H (")	W x D x H (mm)	Code	All Laminate (\$)	HPL Surfaces (\$)
<b>Laptop tables, 30" D, incremental height adjustment</b>	<i>Metal legs. 1" (25 mm) incremental height adjustment. 6" (150 mm) range. Lowest position is 25" H (635 mm). Highest position is 31" (785 mm) H. 6" (150 mm) high modesty panel. Wire management raceway accessible by a lockable cover on hinges.</i>				
	72 x 30 x 25-31	1800 x 750 x 635-785	<b>E_N-RLP3072I</b>	<b>1,917</b>	<b>2,205</b>
	66 x 30 x 25-31	1650 x 750 x 635-785	<b>E_N-RLP3066I</b>	<b>1,903</b>	<b>2,151</b>
	60 x 30 x 25-31	1500 x 750 x 635-785	<b>E_N-RLP3060I</b>	<b>1,873</b>	<b>2,109</b>
	54 x 30 x 25-31	1350 x 750 x 635-785	<b>E_N-RLP3054I</b>	<b>1,848</b>	<b>2,059</b>
	48 x 30 x 25-31	1200 x 750 x 635-785	<b>E_N-RLP3048I</b>	<b>1,821</b>	<b>2,016</b>
	42 x 30 x 25-31	1050 x 750 x 635-785	<b>E_N-RLP3042I</b>	<b>1,795</b>	<b>1,962</b>
	36 x 30 x 25-31	900 x 750 x 635-785	<b>E_N-RLP3036I</b>	<b>1,768</b>	<b>1,910</b>

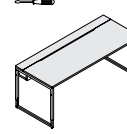

	W x D x H (")	W x D x H (mm)	Code	All Laminate (\$)	HPL Surfaces (\$)
<b>Laptop tables, 24" D, incremental height adjustment</b>	<i>Metal legs. 1" (25 mm) incremental height adjustment. 6" (150 mm) range. Lowest position is 25" H (635 mm). Highest position is 31" (785 mm) H. 6" (150 mm) high modesty panel. Wire management raceway accessible by a lockable cover on hinges.</i>				
	72 x 24 x 25-31	1800 x 600 x 635-785	<b>E_N-RLP2472I</b>	<b>1,880</b>	<b>2,109</b>
	66 x 24 x 25-31	1650 x 600 x 635-785	<b>E_N-RLP2466I</b>	<b>1,866</b>	<b>2,065</b>
	60 x 24 x 25-31	1500 x 600 x 635-785	<b>E_N-RLP2460I</b>	<b>1,841</b>	<b>2,030</b>
	54 x 24 x 25-31	1350 x 600 x 635-785	<b>E_N-RLP2454I</b>	<b>1,821</b>	<b>1,988</b>
	48 x 24 x 25-31	1200 x 600 x 635-785	<b>E_N-RLP2448I</b>	<b>1,795</b>	<b>1,945</b>
	42 x 24 x 25-31	1050 x 600 x 635-785	<b>E_N-RLP2442I</b>	<b>1,768</b>	<b>1,910</b>
	36 x 24 x 25-31	900 x 600 x 635-785	<b>E_N-RLP2436I</b>	<b>1,753</b>	<b>1,866</b>

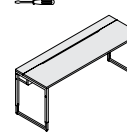

	W x D x H (")	W x D x H (mm)	Code	All Laminate (\$)	HPL Surfaces (\$)
<b>Laptop tables, 30" D, fixed height</b>	<i>Metal legs. 6" (150 mm) high modesty panel. Wire management raceway accessible by a lockable cover on hinges.</i>				
	72 x 30 x 29	1800 x 750 x 735	<b>E_N-RLP3072J</b>	<b>1,612</b>	<b>1,892</b>
	66 x 30 x 29	1650 x 750 x 735	<b>E_N-RLP3066J</b>	<b>1,587</b>	<b>1,848</b>
	60 x 30 x 29	1500 x 750 x 735	<b>E_N-RLP3060J</b>	<b>1,563</b>	<b>1,795</b>
	54 x 30 x 29	1350 x 750 x 735	<b>E_N-RLP3054J</b>	<b>1,535</b>	<b>1,743</b>
	48 x 30 x 29	1200 x 750 x 735	<b>E_N-RLP3048J</b>	<b>1,509</b>	<b>1,700</b>
	42 x 30 x 29	1050 x 750 x 735	<b>E_N-RLP3042J</b>	<b>1,483</b>	<b>1,649</b>
	36 x 30 x 29	900 x 750 x 735	<b>E_N-RLP3036J</b>	<b>1,455</b>	<b>1,603</b>

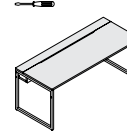

	W x D x H (")	W x D x H (mm)	Code	All Laminate (\$)	HPL Surfaces (\$)
<b>Laptop tables, 24" D, fixed height</b>	<i>Metal legs. 6" (150 mm) high modesty panel. Wire management raceway accessible by a lockable cover on hinges.</i>				
	72 x 24 x 29	1800 x 600 x 735	<b>E_N-RLP2472J</b>	<b>1,570</b>	<b>1,795</b>
	66 x 24 x 29	1650 x 600 x 735	<b>E_N-RLP2466J</b>	<b>1,551</b>	<b>1,761</b>
	60 x 24 x 29	1500 x 600 x 735	<b>E_N-RLP2460J</b>	<b>1,526</b>	<b>1,714</b>
	54 x 24 x 29	1350 x 600 x 735	<b>E_N-RLP2454J</b>	<b>1,509</b>	<b>1,672</b>
	48 x 24 x 29	1200 x 600 x 735	<b>E_N-RLP2448J</b>	<b>1,483</b>	<b>1,629</b>
	42 x 24 x 29	1050 x 600 x 735	<b>E_N-RLP2442J</b>	<b>1,465</b>	<b>1,595</b>
	36 x 24 x 29	900 x 600 x 735	<b>E_N-RLP2436J</b>	<b>1,437</b>	<b>1,551</b>

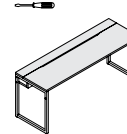

# EDUCATIONAL FURNITURE

	W x D x H (*)	W x D x H (mm)	Code	All Laminate (\$)	HPL Surfaces (\$)
--	---------------	----------------	------	-------------------	-------------------

## CPU TABLES

**Left CPU tables** *Open CPU storage on left: 8¾" W x 20½" H (222 x 522 mm). Half-height modesty panel. Grommet on sides. Wire management raceway accessible by a lockable cover on hinges.*



42 x 30 x 36	1050 x 750 x 911	E_N_-CPU3042S	1,962	2,083
42 x 24 x 36	1050 x 600 x 911	E_N_-CPU2442S	1,873	1,970

Specify the surface type (1, 2). Specify the accent color (A, S).

Packaged in 2 boxes.

**Right CPU tables** *Open CPU storage on left: 8¾" W x 20½" H (222 x 522 mm). Half-height modesty panel. Grommet on sides. Wire management raceway accessible by a lockable cover on hinges.*



42 x 30 x 36	1050 x 750 x 911	E_N_-S3042CPU	1,962	2,083
42 x 24 x 36	1050 x 600 x 911	E_N_-S2442CPU	1,873	1,970

Specify the surface type (1, 2). Specify the accent color (A, S).

Packaged in 2 boxes.

## ALL-PURPOSE TABLES

**Rectangular tables** *Disc bases.*

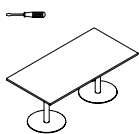

72 x 42 x 29	1800 x 1050 x 738	E_N_-RC4272D	2,927	3,321
72 x 36 x 29	1800 x 900 x 738	E_N_-RC3672D	2,894	3,235
60 x 30 x 29	1500 x 750 x 738	E_N_-RC3060D	2,828	3,060

Specify the surface type (1, 2). Specify the accent color (A, S).

Packaged in 5 boxes.

**Rectangular café height tables** *Disc bases.*

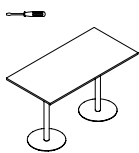

72 x 42 x 42	1800 x 1050 x 1067	E_N_-RC427242D	3,078	3,466
72 x 36 x 42	1800 x 900 x 1067	E_N_-RC367242D	3,041	3,383
60 x 30 x 42	1500 x 750 x 1067	E_N_-RC306042D	2,973	3,207

Specify the surface type (1, 2). Specify the accent color (A, S).

Packaged in 5 boxes.

**Round tables** *Disc base.*

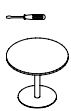

48 x 48 x 29	1200 x 1200 x 738	E_N_-R48D	1,931	2,240
42 x 42 x 29	1050 x 1050 x 738	E_N_-R42D	1,892	2,118
36 x 36 x 29	900 x 900 x 738	E_N_-R36D	1,595	1,761

Specify the surface type (1, 2). Specify the accent color (A, S).

Packaged in 3 boxes.

**Round café height tables** *Disc base.*

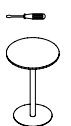

36 x 36 x 42	900 x 900 x 1067	E_N_-R3642D	1,526	1,761
30 x 30 x 42	750 x 750 x 1067	E_N_-R3042D	1,476	1,629

Specify the surface type (1, 2). Specify the accent color (A, S).

Packaged in 3 boxes.

## COMPLEMENTARY FURNITURE

**Pedestal** *2 box drawers and 1 file drawer with suspension bar. Pencil tray. Lock controls all drawers.*



16¾ x 26 x 29	409 x 650 x 735	E1_-P1626UF	1,700	-
---------------	-----------------	-------------	-------	---

Specify the handle code (L, Q, V). Specify the accent color (A, S).

**Pedestal** *2 file drawers with suspension bar. Lock controls all drawers.*



16¾ x 26 x 29	409 x 650 x 735	E1_-P1626FF	1,455	-
---------------	-----------------	-------------	-------	---

Specify the handle code (L, Q, V). Specify the accent color (A, S).

	W x D x H (*)	W x D x H (mm)	Code	All Laminate (\$)	HPL Surfaces (\$)
--	---------------	----------------	------	-------------------	-------------------

## Bookcase unit

*1 adjustable shelf. 1 tone only.*



12 x 26 x 28	300 x 650 x 710	ENNN-B262812	813	-
--------------	-----------------	--------------	-----	---

## Teacher's cart

*Handle on left side. 1 adjustable shelf. 1 fixed shelf with 22½" W x 21⅝" D x 5¼" H (572 x 551 x 134 mm) open storage space. Swivel wire supports. 1 grommet on top and 1 grommet on back. 4 swivel casters, 2 with brakes.*



25 x 24 x 39	625 x 600 x 988	E_N_-M242539	1,444	1,526
--------------	-----------------	--------------	-------	-------

Specify the surface type (1, 2). Specify the accent color (A, S).

## Teacher's cart

*Handle on left side. 1 adjustable shelf. 1 fixed shelf with 22½" W x 21⅝" D x 5¼" H (572 x 551 x 134 mm) open storage space. Swivel wire supports. 1 grommet on top and 1 grommet on back. Flipper shelf on right side. 4 swivel casters, 2 with brakes.*



37¼ x 24 x 39	945 x 600 x 988	E_N_-M242539W	1,753	1,828
---------------	-----------------	---------------	-------	-------

Specify the surface type (1, 2). Specify the accent color (A, S).

## Teacher's cart with doors

*Handle on left side. 1 adjustable shelf. 1 fixed shelf with 22½" W x 21⅝" D x 5¼" H (572 x 551 x 134 mm) open storage space. Lock. Swivel wire supports. 1 grommet on top and 1 grommet on back. 4 swivel casters, 2 with brakes.*



25 x 24 x 39	625 x 600 x 988	E_-M242539B	1,880	1,962
--------------	-----------------	-------------	-------	-------

Specify the surface type (1, 2). Specify the handle code (L, Q, V). Specify the accent color (A, S).

## Teacher's cart with doors

*Handle on left side. 1 adjustable shelf. 1 fixed shelf with 22½" W x 21⅝" D x 5¼" H (572 x 551 x 134 mm) open storage space. Lock. Swivel wire supports. 1 grommet on top and 1 grommet on back. Flipper shelf on right side. 4 swivel casters, 2 with brakes.*



37¼ x 24 x 39	945 x 600 x 988	E_-M242539BW	2,118	2,194
---------------	-----------------	--------------	-------	-------

Specify the surface type (1, 2). Specify the handle code (L, Q, V). Specify the accent color (A, S).

## Lectern

*Small acrylic screen. 1 fixed shelf. 1 adjustable shelf. 1 storage space. Wiring access. 4 swivel casters, 2 with brakes. 1 tone only.*



24 x 18 x 47	600 x 448 x 1177	ENNN-LC241846	1,587	-
--------------	------------------	---------------	-------	---

## Laptop cart, 30 units

*Can accommodate 30 laptops. 2 handles on top. Laminate door fronts with lock. Swivel wire supports. Perforated back metal doors with lock for ventilation. Storage space for wire management and transformers. Grommet on sides. 4 swivel casters, 2 with brakes. Surge and protection power bar sold separately.*



43 x 25 x 42	1075 x 625 x 1063	E_-M254342LP	4,855	4,996
--------------	-------------------	--------------	-------	-------

Specify the surface type (1, 2). Specify the handle code (Q, V). Specify the accent color (A, S).

## Laptop cart, 20 units

*Can accommodate 20 laptops. 2 handles on top. Laminate door fronts with lock. Swivel wire supports. Perforated back metal doors with lock for ventilation. Storage space for wire management and transformers. Grommet on sides. 4 swivel casters, 2 with brakes. Surge and protection power bar sold separately.*



30 x 25 x 42	750 x 625 x 1063	E_-M253042LP	4,472	4,577
--------------	------------------	--------------	-------	-------

Specify the surface type (1, 2). Specify the handle code (Q, V). Specify the accent color (A, S).

## Power bar

*10 electrical outlets. Black. Mounting brackets included. 12' electrical cord (3658 mm).*



1¾ x 2¼ x 17½	44 x 57 x 447	LGC-POWERBAR	691	-
---------------	---------------	--------------	-----	---

## Flat screen carts

*Laminate doors with locks. 2 adjustable shelves. Recessed back panel for wire management. Grommets on back. 6 swivel casters, 4 with brakes. 1 tone only. Flat screen support sold separately.*

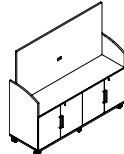

72 x 24 x 64	1800 x 600 x 1625	EN_-MTV2472	3,034	-
--------------	-------------------	-------------	-------	---

54 x 24 x 64	1350 x 600 x 1625	EN_-MTV2454	2,781	-
--------------	-------------------	-------------	-------	---

Specify the handle code (L, Q, V). Specify the accent color (A, S).

72" W accommodates 37" to 65" flat screens.  
54" W accommodates 37" to 50" flat screens.

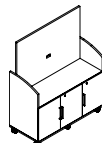

= ASSEMBLY REQUIRED

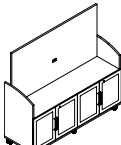
	W x D x H (")	W x D x H (mm)	Code	All Laminate (\$)	HPL Surfaces (\$)
<b>Flat screen carts with translucent doors</b> 	<i>Silver anodized frame doors and translucent insert with locks. 2 adjustable shelves. Recessed back panel for wire management. Grommets on back. 6 swivel casters, 4 with brakes. 1 tone only. Flat screen support sold separately. S Silver accent only.</i>				
	72 x 24 x 64	1800 x 600 x 1625	EN_S-MTV2472T	3,906	-
	54 x 24 x 64	1350 x 600 x 1625	EN_S-MTV2454T	3,436	-
<b>Specify the handle code (Q, V).</b>					
72" W accommodates 37" to 65" flat screens. 54" W accommodates 37" to 50" flat screens.					

	W x D x H (")	W x D x H (mm)	Code	All Laminate (\$)	HPL Surfaces (\$)
<b>Flat screen support</b> 	<i>Silver metal support. Can accommodate screens from 37" to 65". 15° tilt angle. Maximum weight capacity: 165 lbs (75 kg). Install on a flat screen carts.</i>				
	33½ x 3¾ x 9¼	850 x 85 x 235	LGC-SUPFLATSC	411	-

	W x D x H (")	W x D x H (mm)	Code	All Laminate (\$)	HPL Surfaces (\$)
<b>Mobile white boards</b> 	<i>Non-magnetic surface for use with dry-erase markers on both sides. Brakes on swivel casters.</i>				
	55 x 28 x 64	1375 x 700 x 1610	ENN_-MWB542865	2,737	-
	43 x 28 x 64	1075 x 700 x 1610	ENN_-MWB422865	2,683	-
<b>Specify the accent color (A, S).</b>					

	W x D x H (")	W x D x H (mm)	Code	All Laminate (\$)	HPL Surfaces (\$)
<b>Pencil tray</b> 	<i>For mobile white board. Specify the metal finish Silver or Anthracite grey.</i>				
	12 x 3½ x 2	300 x 90 x 50	LGC-PH12_	132	-
<b>Specify the accent color (A, S).</b>					

**STORAGE UNITS, 72" H**

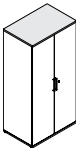
	W x D x H (")	W x D x H (mm)	Code	All Laminate (\$)	HPL Surfaces (\$)
<b>Storage unit with doors</b> 	<i>3 adjustable shelves and 1 fixed shelf. Lock.</i>				
	36 x 24 x 72	900 x 600 x 1825	E1_-B243672	2,554	-
<b>Specify the handle code (L, Q, V). Specify the accent color (A, S).</b>					

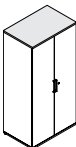
	W x D x H (")	W x D x H (mm)	Code	All Laminate (\$)	HPL Surfaces (\$)
<b>Combined wardrobe/storage unit with doors</b> 	<i>Clothes hanger bar and 1 fixed shelf on right side. 4 adjustable shelves on left side. Lock.</i>				
	36 x 24 x 72	900 x 600 x 1825	E1_-243672BC	2,816	-
<b>Specify the handle code (L, Q, V). Specify the accent color (A, S).</b>					

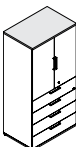
	W x D x H (")	W x D x H (mm)	Code	All Laminate (\$)	HPL Surfaces (\$)
<b>Storage unit with drawers</b> 	<i>2 adjustable shelves. 4 box drawers. Interlock system. Locks.</i>				
	36 x 24 x 72	900 x 600 x 1825	E1_-243672BU	4,375	-
<b>Specify the handle code (L, Q, V). Specify the accent color (A, S).</b>					

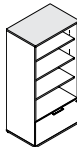
	W x D x H (")	W x D x H (mm)	Code	All Laminate (\$)	HPL Surfaces (\$)
<b>Open bookcase with drawer</b> 	<i>2 adjustable shelves and 1 fixed shelf. Lateral file drawer with suspension bars. Lock.</i>				
	36 x 24 x 72	900 x 600 x 1825	E1_-B243672F	2,512	-
<b>Specify the handle code (L, Q, V). Specify the accent color (A, S).</b>					

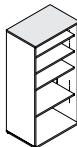
	W x D x H (")	W x D x H (mm)	Code	All Laminate (\$)	HPL Surfaces (\$)
<b>Open bookcase</b> 	<i>3 adjustable shelves and 1 fixed shelf.</i>				
	36 x 24 x 72	900 x 600 x 1825	E1NN-B243672	2,005	-

**STORAGE UNITS, 36" H**

	W x D x H (")	W x D x H (mm)	Code	All Laminate (\$)	HPL Surfaces (\$)
<b>Bookcase with doors</b> 	<i>1 adjustable shelf. Lock.</i>				
	36 x 24 x 36	900 x 600 x 911	E_-_-243636B	1,736	1,848
<b>Specify the surface type (1, 2). Specify the handle code (L, Q, V). Specify the accent color (A, S).</b>					

	W x D x H (")	W x D x H (mm)	Code	All Laminate (\$)	HPL Surfaces (\$)
<b>Mobile bookcase with doors</b> 	<i>1 adjustable shelf. Lock. 4 swivel casters, 2 with brakes.</i>				
	36 x 24 x 36	900 x 600 x 911	E_-_-M243636B	1,805	1,917
<b>Specify the surface type (1, 2). Specify the handle code (L, Q, V). Specify the accent color (A, S).</b>					

	W x D x H (")	W x D x H (mm)	Code	All Laminate (\$)	HPL Surfaces (\$)
<b>Storage unit with drawers</b> 	<i>4 box drawers. Interlock system. Lock.</i>				
	36 x 24 x 36	900 x 600 x 911	E_-_-243636U	3,060	3,173
<b>Specify the surface type (1, 2). Specify the handle code (L, Q, V). Specify the accent color (A, S).</b>					

	W x D x H (")	W x D x H (mm)	Code	All Laminate (\$)	HPL Surfaces (\$)
<b>Mobile storage unit with drawers</b> 	<i>4 box drawers. Interlock system. Lock. 4 swivel casters, 2 with brakes.</i>				
	36 x 24 x 36	900 x 600 x 911	E_-_-M243636U	3,130	3,242
<b>Specify the surface type (1, 2). Specify the handle code (L, Q, V). Specify the accent color (A, S).</b>					

	W x D x H (")	W x D x H (mm)	Code	All Laminate (\$)	HPL Surfaces (\$)
<b>Combined storage unit</b> 	<i>4 box drawers on left. Bookcase with door on right. 1 adjustable shelf. Locks.</i>				
	36 x 24 x 36	900 x 600 x 911	E_-_-243636UB	3,383	3,496
<b>Specify the surface type (1, 2). Specify the handle code (Q, V). Specify the accent color (A, S).</b>					

	W x D x H (")	W x D x H (mm)	Code	All Laminate (\$)	HPL Surfaces (\$)
<b>Mobile combined storage unit</b> 	<i>4 box drawers on left. Bookcase with door on right. 1 adjustable shelf. Locks. 4 swivel casters, 2 with brakes.</i>				
	36 x 24 x 36	900 x 600 x 911	E_-_-M243636UB	3,452	3,565
<b>Specify the surface type (1, 2). Specify the handle code (Q, V). Specify the accent color (A, S).</b>					

	W x D x H (")	W x D x H (mm)	Code	All Laminate (\$)	HPL Surfaces (\$)
<b>Combined storage unit</b> 	<i>4 box drawers on right. Bookcase with door on left. 1 adjustable shelf. Locks.</i>				
	36 x 24 x 36	900 x 600 x 911	E_-_-243636BU	3,383	3,496
<b>Specify the surface type (1, 2). Specify the handle code (Q, V). Specify the accent color (A, S).</b>					

	W x D x H (")	W x D x H (mm)	Code	All Laminate (\$)	HPL Surfaces (\$)
<b>Mobile combined storage unit</b>	<i>4 box drawers on right. Bookcase with door on left. 1 adjustable shelf. Locks. 4 swivel casters, 2 with brakes.</i>				
	36 x 24 x 36	900 x 600 x 911	E___-M243636BU	3,452	3,565
	Specify the surface type (1, 2). Specify the handle code (Q, V). Specify the accent color (A, S).				

<b>Combined storage unit</b>	<i>2 box drawers. Bookcase with doors. 1 adjustable shelf. Locks.</i>				
	36 x 24 x 36	900 x 600 x 911	E___-243636T	2,701	2,816
	Specify the surface type (1, 2). Specify the handle code (L, Q, V). Specify the accent color (A, S).				

<b>Mobile combined storage unit</b>	<i>2 box drawers. Bookcase with doors. 1 adjustable shelf. Locks. 4 swivel casters, 2 with brakes.</i>				
	36 x 24 x 36	900 x 600 x 911	E___-M243636T	2,776	2,886
	Specify the surface type (1, 2). Specify the handle code (L, Q, V). Specify the accent color (A, S).				

**STORAGE UNITS, 29" H**

<b>Bookcase with doors</b>	<i>1 adjustable shelf. Lock.</i>				
	36 x 24 x 29	900 x 600 x 735	E___-243629B	1,664	1,774
	Specify the surface type (1, 2). Specify the handle code (L, Q, V). Specify the accent color (A, S).				

<b>Mobile bookcase with doors</b>	<i>1 adjustable shelf. Lock. 4 swivel casters, 2 with brakes.</i>				
	36 x 24 x 29	900 x 600 x 735	E___-M243629B	1,736	1,848
	Specify the surface type (1, 2). Specify the handle code (L, Q, V). Specify the accent color (A, S).				

<b>Bookcase with door, opens left</b>	<i>1 adjustable shelf. Lock.</i>				
	24 x 24 x 29	600 x 600 x 735	E___-242429BL	1,535	1,612
	Specify the surface type (1, 2). Specify the handle code (Q, V). Specify the accent color (A, S).				

<b>Bookcase with door, opens right</b>	<i>1 adjustable shelf. Lock.</i>				
	24 x 24 x 29	600 x 600 x 735	E___-242429BR	1,535	1,612
	Specify the surface type (1, 2). Specify the handle code (Q, V). Specify the accent color (A, S).				

<b>Mobile bookcase with door, opens left</b>	<i>1 adjustable shelf. 4 swivel casters, 2 with brakes. Lock.</i>				
	24 x 24 x 29	600 x 600 x 735	E___-M242429BL	1,603	1,684
	Specify the surface type (1, 2). Specify the handle code (Q, V). Specify the accent color (A, S).				

<b>Mobile bookcase with door, opens right</b>	<i>1 adjustable shelf. 4 swivel casters, 2 with brakes. Lock.</i>				
	24 x 24 x 29	600 x 600 x 735	E___-M242429BR	1,603	1,684
	Specify the surface type (1, 2). Specify the handle code (Q, V). Specify the accent color (A, S).				

<b>Storage units with drawers</b>	<i>3 box drawers. Interlock system. Lock.</i>				
	36 x 24 x 29	900 x 600 x 735	E___-243629U	2,776	2,886
	24 x 24 x 29	600 x 600 x 735	E___-242429U	2,676	2,787
	Specify the surface type (1, 2). Specify the handle code (L, Q, V). Specify the accent color (A, S).				

	W x D x H (")	W x D x H (mm)	Code	All Laminate (\$)	HPL Surfaces (\$)
<b>Mobile storage units with drawers</b>	<i>3 box drawers. Interlock system. Lock. 4 swivel casters, 2 with brakes.</i>				
	36 x 24 x 29	900 x 600 x 735	E___-M243629U	2,841	2,955
	24 x 24 x 29	600 x 600 x 735	E___-M242429U	2,747	2,860
	Specify the surface type (1, 2). Specify the handle code (L, Q, V). Specify the accent color (A, S).				

<b>Combined storage unit</b>	<i>3 box drawers on left. Bookcase with door on right. 1 adjustable shelf. Locks.</i>				
	36 x 24 x 29	900 x 600 x 735	E___-243629UB	2,747	2,860
	Specify the surface type (1, 2). Specify the handle code (Q, V). Specify the accent color (A, S).				

<b>Mobile combined storage unit</b>	<i>3 box drawers on left. Bookcase with door on right. 1 adjustable shelf. Locks. 4 swivel casters, 2 with brakes.</i>				
	36 x 24 x 29	900 x 600 x 735	E___-M243629UB	2,816	2,927
	Specify the surface type (1, 2). Specify the handle code (Q, V). Specify the accent color (A, S).				

<b>Combined storage unit</b>	<i>3 box drawers on right. Bookcase with door on left. 1 adjustable shelf. Locks.</i>				
	36 x 24 x 29	900 x 600 x 735	E___-243629BU	2,747	2,860
	Specify the surface type (1, 2). Specify the handle code (Q, V). Specify the accent color (A, S).				

<b>Mobile combined storage unit</b>	<i>3 box drawers on right. Bookcase with door on left. 1 adjustable shelf. Locks. 4 swivel casters, 2 with brakes.</i>				
	36 x 24 x 29	900 x 600 x 735	E___-M243629BU	2,816	2,927
	Specify the surface type (1, 2). Specify the handle code (Q, V). Specify the accent color (A, S).				

**BOOKCASE UNITS, 36" H**

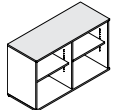
<b>Bookcase units</b>	<i>2 adjustable shelves.</i>				
	60 x 24 x 36	1500 x 600 x 911	E_NN-B246036	1,491	1,642
	48 x 24 x 36	1200 x 600 x 911	E_NN-B244836	1,332	1,465
	<i>1 adjustable shelf.</i>				
	36 x 24 x 36	900 x 600 x 911	E_NN-B243636	1,192	1,309
	Specify the surface type (1, 2).				

<b>Mobile bookcase units</b>	<i>2 adjustable shelves. 6 swivel casters, 4 with brakes.</i>				
	60 x 24 x 36	1500 x 600 x 911	E_NN-MB246036	1,595	1,743
	48 x 24 x 36	1200 x 600 x 911	E_NN-MB244836	1,437	1,570
	<i>1 adjustable shelf. 4 swivel casters, 2 with brakes.</i>				
	36 x 24 x 36	900 x 600 x 911	E_NN-MB243636	1,265	1,378
	Specify the surface type (1, 2).				

**BOOKCASE UNITS, 29" H**

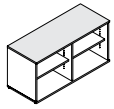
<b>Bookcase units</b>	<i>2 adjustable shelves.</i>				
	60 x 24 x 29	1500 x 600 x 735	E_NN-B246029	1,455	1,595
	48 x 24 x 29	1200 x 600 x 735	E_NN-B244829	1,309	1,425
	<i>1 adjustable shelf.</i>				
	36 x 24 x 29	900 x 600 x 735	E_NN-B243629	1,159	1,272
	Specify the surface type (1, 2).				

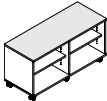

	W x D x H (")	W x D x H (mm)	Code	All Laminate (\$)	HPL Surfaces (\$)
<b>Mobile bookcase units</b>	<i>2 adjustable shelves. 6 swivel casters, 4 with brakes.</i>				
	60 x 24 x 29	1500 x 600 x 735	E_NN-MB246029	1,563	1,700
	48 x 24 x 29	1200 x 600 x 735	E_NN-MB244829	1,412	1,526
	<i>1 adjustable shelf. 4 swivel casters, 2 with brakes.</i>				
	36 x 24 x 29	900 x 600 x 735	E_NN-MB243629	1,231	1,344

Specify the surface type (1, 2).

<b>Handle</b>	<i>For mobile units. Specify the metal finish Silver or Anthracite grey.</i>				
	17¼ x ¾ x 2¾	438 x 22 x 60	LGC-PULL17_	165	-

Specify the accent color (A, S).

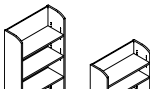
<b>Bookcases</b>	<i>3 adjustable shelves. 1 fixed shelf. 1 tone only.</i>				
	36 x 14 x 72	900 x 350 x 1825	ENNN-B367214	1,430	-
	<i>2 adjustable shelves. 1 fixed shelf. 1 tone only.</i>				
	36 x 14 x 48	900 x 350 x 1215	ENNN-B364814	1,192	-

**MODULAR CABINETRY**

<b>Modular cabinet with doors</b>	<i>Installs under a countertop. 1 adjustable shelf. 4¼" H (106 mm) kick plate. Lock. 1 tone only.</i>				
	36 x 25 x 35	900 x 625 x 886	EN__-253635BL	1,736	-

Specify the handle code (L, Q, V). Specify the accent color (A, S).

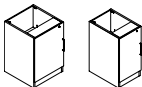
<b>Modular cabinets with door, opens left</b>	<i>Installs under a countertop. 1 adjustable shelf. 4¼" H (106 mm) kick plate. Lock. 1 tone only.</i>				
	24 x 25 x 35	600 x 625 x 886	EN__-252435BLL	1,603	-
	18 x 25 x 35	450 x 625 x 886	EN__-251835BLL	1,231	-

Specify the handle code (Q, V). Specify the accent color (A, S).

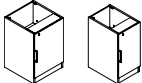
<b>Modular cabinets with door, opens right</b>	<i>Installs under a countertop. 1 adjustable shelf. 4¼" H (106 mm) kick plate. Lock. 1 tone only.</i>				
	24 x 25 x 35	600 x 625 x 886	EN__-252435BLR	1,603	-
	18 x 25 x 35	450 x 625 x 886	EN__-251835BLR	1,231	-

Specify the handle code (Q, V). Specify the accent color (A, S).

<b>Modular sink cabinet with doors</b>	<i>Installs under a countertop. 4¼" H (106 mm) kick plate. Open back to accommodate plumbing. Lock. 1 tone only.</i>				
	36 x 25 x 35	900 x 625 x 886	EN__-253635KL	1,828	-

Specify the handle code (L, Q, V). Specify the accent color (A, S).

<b>Modular sink cabinet with door, opens left</b>	<i>Installs under a countertop. 4¼" H (106 mm) kick plate. Open back to accommodate plumbing. Lock. 1 tone only.</i>				
	24 x 25 x 35	600 x 625 x 886	EN__-252435KLL	1,700	-

Specify the handle code (Q, V). Specify the accent color (A, S).

<b>Modular sink cabinet with door, opens right</b>	<i>Installs under a countertop. 4¼" H (106 mm) kick plate. Open back to accommodate plumbing. Lock. 1 tone only.</i>				
	24 x 25 x 35	600 x 625 x 886	EN__-252435KLR	1,700	-

Specify the handle code (Q, V). Specify the accent color (A, S).

<b>Modular cabinet with drawers</b>	<i>Installs under a countertop. 4 drawers. 4¼" H (106 mm) kick plate. Lock. 1 tone only.</i>				
	36 x 25 x 35	900 x 625 x 886	EN__-253635UL	2,642	-

Specify the handle code (L, Q, V). Specify the accent color (A, S).

<b>Modular cabinets with drawers</b>	<i>Installs under a countertop. 4 drawers. 4¼" H (106 mm) kick plate. Lock. 1 tone only.</i>				
	24 x 25 x 35	600 x 625 x 886	EN__-252435UL	2,512	-
	18 x 25 x 35	450 x 625 x 886	EN__-251835UL	2,283	-

Specify the handle code (L, Q, V). Specify the accent color (A, S).

<b>Modular cabinet with drawers</b>	<i>Installs under a countertop. 3 box drawers and 1 file drawer. 4¼" H (106 mm) kick plate. Locks. 1 tone only.</i>				
	36 x 25 x 35	900 x 625 x 886	EN__-253635UFL	2,597	-

Specify the handle code (L, Q, V). Specify the accent color (A, S).

<b>Modular cabinet with drawers</b>	<i>Installs under a countertop. 2 box drawers and 1 file drawer. 4¼" H (106 mm) kick plate. Lock. 1 tone only.</i>				
	24 x 25 x 35	600 x 625 x 886	EN__-252435UFL	2,467	-

Specify the handle code (L, Q, V). Specify the accent color (A, S).

<b>Modular cabinet with doors and drawers</b>	<i>Installs under a countertop. 2 box drawers. 1 adjustable shelf. 4¼" H (106 mm) kick plate. Locks. 1 tone only.</i>				
	36 x 25 x 35	900 x 625 x 886	EN__-253635TL	2,187	-

Specify the handle code (L, Q, V). Specify the accent color (A, S).

<b>Modular cabinet with door and drawer, opens left</b>	<i>Installs under a countertop. 1 box drawer. 1 adjustable shelf. 4¼" H (106 mm) kick plate. Lock. 1 tone only.</i>				
	24 x 25 x 35	600 x 625 x 886	EN__-252435TLL	2,059	-

Specify the handle code (Q, V). Specify the accent color (A, S).

<b>Modular cabinet with door and drawer, opens right</b>	<i>Installs under a countertop. 1 box drawer. 1 adjustable shelf. 4¼" H (106 mm) kick plate. Lock. 1 tone only.</i>				
	24 x 25 x 35	600 x 625 x 886	EN__-252435TLR	2,059	-

Specify the handle code (Q, V). Specify the accent color (A, S).

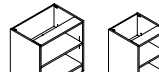
<b>Modular bookcases</b>	<i>Installs under a countertop. 1 adjustable shelf. 4¼" H (106 mm) kick plate. 1 tone only.</i>				
	36 x 25 x 35	900 x 625 x 886	ENNN-B253635L	1,278	-
	24 x 25 x 35	600 x 625 x 886	ENNN-B252435L	1,152	-

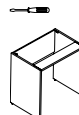
<b>Open modules</b>	<i>Installs under a countertop. 1 tone only.</i>				
	36 x 25 x 35	900 x 625 x 886	ENNN-253635SL	829	-
	24 x 25 x 35	600 x 625 x 886	ENNN-252435SL	777	-

<b>ADA sink module</b>	<i>Installs under a countertop. Open back to accommodate plumbing. Pivoting front panel for plumbing accessibility. 1 tone only.</i>				
	36 x 25 x 35	900 x 625 x 886	ENNN-AD253635L	1,117	-

# EDUCATIONAL FURNITURE

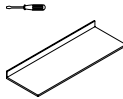
	W x D x H (*)	W x D x H (mm)	Code	All Laminate (\$)	HPL Surfaces (\$)
<b>Rectangular counter tops</b>	<i>Installs on modular cabinets. 4" H (100 mm) back splash. 1 tone only.</i>				
	96 x 26 x 5	2400 x 650 x 125	E_NN-TOBS2696	698	1,052
	90 x 26 x 5	2250 x 650 x 125	E_NN-TOBS2690	680	1,029
	84 x 26 x 5	2100 x 650 x 125	E_NN-TOBS2684	664	1,002
	78 x 26 x 5	1950 x 650 x 125	E_NN-TOBS2678	645	976
	72 x 26 x 5	1800 x 650 x 125	E_NN-TOBS2672	627	948
	66 x 26 x 5	1650 x 650 x 125	E_NN-TOBS2666	609	926
	60 x 26 x 5	1500 x 650 x 125	E_NN-TOBS2660	594	899
	54 x 26 x 5	1350 x 650 x 125	E_NN-TOBS2654	575	870
	48 x 26 x 5	1200 x 650 x 125	E_NN-TOBS2648	560	856
	42 x 26 x 5	1050 x 650 x 125	E_NN-TOBS2642	539	836
	36 x 26 x 5	900 x 650 x 125	E_NN-TOBS2636	523	820
	24 x 26 x 5	600 x 650 x 125	E_NN-TOBS2624	515	803
	18 x 26 x 5	450 x 650 x 125	E_NN-TOBS2618	508	783
	<b>Specify the surface type (1, 2).</b>				

	W x D x H (*)	W x D x H (mm)	Code	All Laminate (\$)	HPL Surfaces (\$)
<b>Open storage module</b>	<i>Installs on a countertop. 2 adjustable shelves. 2 grommets. 1 tone only.</i>				
	48 x 20 x 36	1200 x 500 x 911	ENNN-M0483620	1,412	-

	W x D x H (*)	W x D x H (mm)	Code	All Laminate (\$)	HPL Surfaces (\$)
<b>Open storage module</b>	<i>Installs on a countertop. 1 adjustable shelf. 1 grommet. 1 tone only.</i>				
	24 x 20 x 36	600 x 500 x 911	ENNN-M0243620	1,159	-

## WALL-MOUNTED SYSTEM FOR ACCESSORIES

	W x D x H (*)	W x D x H (mm)	Code	All Laminate (\$)	HPL Surfaces (\$)
<b>Laminate hanging systems</b>	<i>5/8" (16 mm) thick laminate panel. Installation requires appropriate fastening hardware (not included) depending on wall type. 1 tone only.</i>				
	96 x 5/8 x 14	2400 x 16 x 356	ENNN-WMS96	508	-
	90 x 5/8 x 14	2250 x 16 x 356	ENNN-WMS90	496	-
	84 x 5/8 x 14	2100 x 16 x 356	ENNN-WMS84	488	-
	78 x 5/8 x 14	1950 x 16 x 356	ENNN-WMS78	480	-
	72 x 5/8 x 14	1800 x 16 x 356	ENNN-WMS72	472	-
	66 x 5/8 x 14	1650 x 16 x 356	ENNN-WMS66	462	-
	60 x 5/8 x 14	1500 x 16 x 356	ENNN-WMS60	451	-
	54 x 5/8 x 14	1350 x 16 x 356	ENNN-WMS54	443	-
	48 x 5/8 x 14	1200 x 16 x 356	ENNN-WMS48	435	-
	42 x 5/8 x 14	1050 x 16 x 356	ENNN-WMS42	428	-
	36 x 5/8 x 14	900 x 16 x 356	ENNN-WMS36	420	-
	30 x 5/8 x 14	750 x 16 x 356	ENNN-WMS30	410	-

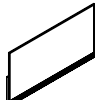
	W x D x H (*)	W x D x H (mm)	Code	All Laminate (\$)	HPL Surfaces (\$)
<b>Porcelain white boards</b>	<i>Porcelain magnetic surface for use with dry-erase markers. Pencil tray. Silver anodized aluminum frame. To be used with the Laminate hanging system (sold separately). 1 tone only.</i>				
	96 x 4 1/8 x 48	2400 x 104 x 1219	ENNS-WB9648	3,049	-
	72 x 4 1/8 x 48	1800 x 104 x 1219	ENNS-WB7248	2,441	-
	48 x 4 1/8 x 48	1200 x 104 x 1219	ENNS-WB4848	1,953	-
	96 x 4 1/8 x 42	2400 x 104 x 1067	ENNS-WB9642	2,973	-
	72 x 4 1/8 x 42	1800 x 104 x 1067	ENNS-WB7242	2,378	-
	48 x 4 1/8 x 42	1200 x 104 x 1067	ENNS-WB4842	1,903	-
	96 x 4 1/8 x 36	2400 x 104 x 914	ENNS-WB9636	2,902	-
	72 x 4 1/8 x 36	1800 x 104 x 914	ENNS-WB7236	2,319	-
	48 x 4 1/8 x 36	1200 x 104 x 914	ENNS-WB4836	1,856	-

## Tackboards

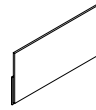

	W x D x H (*)	W x D x H (mm)	Code	All Laminate (\$)	HPL Surfaces (\$)
	<i>Natural cork. To be used with the Laminate hanging system (sold separately). 1 tone only.</i>				
	96 x 1 3/4 x 48	2400 x 44 x 1219	ENN_-TKC9648	1,425	-
	72 x 1 3/4 x 48	1800 x 44 x 1219	ENN_-TKC7248	1,231	-
	48 x 1 3/4 x 48	1200 x 44 x 1219	ENN_-TKC4848	1,046	-
	96 x 1 3/4 x 42	2400 x 44 x 1067	ENN_-TKC9642	1,332	-
	72 x 1 3/4 x 42	1800 x 44 x 1067	ENN_-TKC7242	1,168	-
	48 x 1 3/4 x 42	1200 x 44 x 1067	ENN_-TKC4842	1,002	-
	96 x 1 3/4 x 36	2400 x 44 x 914	ENN_-TKC9636	1,246	-
	72 x 1 3/4 x 36	1800 x 44 x 914	ENN_-TKC7236	1,098	-
	48 x 1 3/4 x 36	1200 x 44 x 914	ENN_-TKC4836	957	-

Specify the accent color (A, S).

## Cabinets with laminate doors, 16" D



	W x D x H (*)	W x D x H (mm)	Code	All Laminate (\$)	HPL Surfaces (\$)
	<i>Lock. To be used with the Laminate hanging system (sold separately). 1 tone only.</i>				
	36 x 16 x 48	900 x 400 x 1219	EN_-H364816P	1,962	-
	36 x 16 x 36	900 x 400 x 914	EN_-H363616P	1,910	-
	36 x 16 x 30	900 x 400 x 762	EN_-H363016P	1,866	-
	36 x 16 x 24	900 x 400 x 609	EN_-H362416P	1,821	-

48"-30" H:  
2 adjustable shelves.  
24" H:  
1 adjustable shelf.

Specify the handle code (L, Q, V). Specify the accent color (A, S).

## Cabinets with laminate door, 16" D

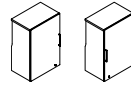

	W x D x H (*)	W x D x H (mm)	Code	All Laminate (\$)	HPL Surfaces (\$)
	<i>Lock. To be used with the Laminate hanging system (sold separately). 1 tone only.</i>				
	24 x 16 x 48	600 x 400 x 1219	EN_-H244816PL	1,727	-
	24 x 16 x 48	600 x 400 x 1219	EN_-H244816PR	1,727	-
	24 x 16 x 36	600 x 400 x 914	EN_-H243616PL	1,684	-
	24 x 16 x 36	600 x 400 x 914	EN_-H243616PR	1,684	-
	24 x 16 x 30	600 x 400 x 762	EN_-H243016PL	1,642	-
	24 x 16 x 30	600 x 400 x 762	EN_-H243016PR	1,642	-
	24 x 16 x 24	600 x 400 x 609	EN_-H242416PL	1,595	-
	24 x 16 x 24	600 x 400 x 609	EN_-H242416PR	1,595	-
	18 x 16 x 48	450 x 400 x 1219	EN_-H184816PL	1,551	-
	18 x 16 x 48	450 x 400 x 1219	EN_-H184816PR	1,551	-
	18 x 16 x 36	450 x 400 x 914	EN_-H183616PL	1,516	-
	18 x 16 x 36	450 x 400 x 914	EN_-H183616PR	1,516	-
	18 x 16 x 30	450 x 400 x 762	EN_-H183016PL	1,483	-
	18 x 16 x 30	450 x 400 x 762	EN_-H183016PR	1,483	-
	18 x 16 x 24	450 x 400 x 609	EN_-H182416PL	1,444	-
	18 x 16 x 24	450 x 400 x 609	EN_-H182416PR	1,444	-

48"-30" H:  
2 adjustable shelves.  
24" H:  
1 adjustable shelf.

L at the end of the code: opens left.  
R at the end of the code: opens right.

Specify the handle code (Q, V). Specify the accent color (A, S).

## Cabinets with laminate doors, 13" D



	W x D x H (*)	W x D x H (mm)	Code	All Laminate (\$)	HPL Surfaces (\$)
	<i>Lock. To be used with the Laminate hanging system (sold separately). 1 tone only.</i>				
	36 x 13 x 48	900 x 325 x 1219	EN_-H364813P	1,925	-
	36 x 13 x 36	900 x 325 x 914	EN_-H363613P	1,873	-
	36 x 13 x 30	900 x 325 x 762	EN_-H363013P	1,828	-
	36 x 13 x 24	900 x 325 x 609	EN_-H362413P	1,789	-

48"-30" H:  
2 adjustable shelves.  
24" H:  
1 adjustable shelf.

Specify the handle code (L, Q, V). Specify the accent color (A, S).

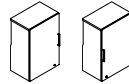
	W x D x H (" )	W x D x H (mm)	Code	All Laminate (\$)	HPL Surfaces (\$)
<b>Cabinets with laminate door, 13" D</b>					
	<i>Lock. To be used with the Laminate hanging system (sold separately). 1 tone only.</i>				
	24 x 13 x 48	600 x 325 x 1219	EN__-H244813PL	1,692	—
	24 x 13 x 48	600 x 325 x 1219	EN__-H244813PR	1,692	—
	24 x 13 x 36	600 x 325 x 914	EN__-H243613PL	1,649	—
	24 x 13 x 36	600 x 325 x 914	EN__-H243613PR	1,649	—
	24 x 13 x 30	600 x 325 x 762	EN__-H243013PL	1,603	—
	24 x 13 x 30	600 x 325 x 762	EN__-H243013PR	1,603	—
	24 x 13 x 24	600 x 325 x 609	EN__-H242413PL	1,563	—
	24 x 13 x 24	600 x 325 x 609	EN__-H242413PR	1,563	—
	18 x 13 x 48	450 x 325 x 1219	EN__-H184813PL	1,516	—
	18 x 13 x 48	450 x 325 x 1219	EN__-H184813PR	1,516	—
	18 x 13 x 36	450 x 325 x 914	EN__-H183613PL	1,483	—
	18 x 13 x 36	450 x 325 x 914	EN__-H183613PR	1,483	—
	18 x 13 x 30	450 x 325 x 762	EN__-H183013PL	1,444	—
	18 x 13 x 30	450 x 325 x 762	EN__-H183013PR	1,444	—
	18 x 13 x 24	450 x 325 x 609	EN__-H182413PL	1,412	—
	18 x 13 x 24	450 x 325 x 609	EN__-H182413PR	1,412	—

48"-30" H:  
2 adjustable shelves.  
24" H:  
1 adjustable shelf.  
L at the end of the code: opens left.  
R at the end of the code: opens right.

Specify the handle code (Q, V). Specify the accent color (A, S).

	W x D x H (" )	W x D x H (mm)	Code	All Laminate (\$)	HPL Surfaces (\$)
<b>Cabinets with translucent doors, 16" D</b>					
	<i>With Silver anodized frame doors and translucent insert. Lock. To be used with the Laminate hanging system (sold separately). 1 tone only.</i>				
	36 x 16 x 48	900 x 400 x 1219	EN_S-H364816T	2,398	—
	36 x 16 x 36	900 x 400 x 914	EN_S-H363616T	2,344	—
	36 x 16 x 30	900 x 400 x 762	EN_S-H363016T	2,303	—
	36 x 16 x 24	900 x 400 x 609	EN_S-H362416T	2,257	—

48"-30" H:  
2 adjustable shelves.  
24" H:  
1 adjustable shelf.

Specify the handle code (Q, V).

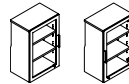
	W x D x H (" )	W x D x H (mm)	Code	All Laminate (\$)	HPL Surfaces (\$)
<b>Cabinets with translucent door, 16" D</b>					
	<i>With Silver anodized frame door and translucent insert. Lock. To be used with the Laminate hanging system (sold separately). 1 tone only.</i>				
	24 x 16 x 48	600 x 400 x 1219	EN_S-H244816TL	1,945	—
	24 x 16 x 48	600 x 400 x 1219	EN_S-H244816TR	1,945	—
	24 x 16 x 36	600 x 400 x 914	EN_S-H243616TL	1,903	—
	24 x 16 x 36	600 x 400 x 914	EN_S-H243616TR	1,903	—
	24 x 16 x 30	600 x 400 x 762	EN_S-H243016TL	1,856	—
	24 x 16 x 30	600 x 400 x 762	EN_S-H243016TR	1,856	—
	24 x 16 x 24	600 x 400 x 609	EN_S-H242416TL	1,813	—
	24 x 16 x 24	600 x 400 x 609	EN_S-H242416TR	1,813	—
	18 x 16 x 48	450 x 400 x 1219	EN_S-H184816TL	1,768	—
	18 x 16 x 48	450 x 400 x 1219	EN_S-H184816TR	1,768	—
	18 x 16 x 36	450 x 400 x 914	EN_S-H183616TL	1,736	—
	18 x 16 x 36	450 x 400 x 914	EN_S-H183616TR	1,736	—
	18 x 16 x 30	450 x 400 x 762	EN_S-H183016TL	1,700	—
	18 x 16 x 30	450 x 400 x 762	EN_S-H183016TR	1,700	—
	18 x 16 x 24	450 x 400 x 609	EN_S-H182416TL	1,664	—
	18 x 16 x 24	450 x 400 x 609	EN_S-H182416TR	1,664	—

48"-30" H:  
2 adjustable shelves.  
24" H:  
1 adjustable shelf.  
L at the end of the code: opens left.  
R at the end of the code: opens right.

Specify the handle code (Q, V).

	W x D x H (" )	W x D x H (mm)	Code	All Laminate (\$)	HPL Surfaces (\$)
<b>Cabinets with translucent doors, 13" D</b>					
	<i>With Silver anodized frame doors and translucent insert. Lock. To be used with the Laminate hanging system (sold separately). 1 tone only.</i>				
	36 x 13 x 48	900 x 325 x 1219	EN_S-H364813T	2,362	—
	36 x 13 x 36	900 x 325 x 914	EN_S-H363613T	2,309	—
	36 x 13 x 30	900 x 325 x 762	EN_S-H363013T	2,266	—
	36 x 13 x 24	900 x 325 x 609	EN_S-H362413T	2,225	—

48"-30" H:  
2 adjustable shelves.  
24" H:  
1 adjustable shelf.

Specify the handle code (Q, V).

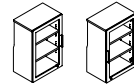
	W x D x H (" )	W x D x H (mm)	Code	All Laminate (\$)	HPL Surfaces (\$)
<b>Cabinets with translucent door, 13" D</b>					
	<i>With Silver anodized frame door and translucent insert. Lock. To be used with the Laminate hanging system (sold separately). 1 tone only.</i>				
	24 x 13 x 48	600 x 325 x 1219	EN_S-H244813TL	1,910	—
	24 x 13 x 48	600 x 325 x 1219	EN_S-H244813TR	1,910	—
	24 x 13 x 36	600 x 325 x 914	EN_S-H243613TL	1,866	—
	24 x 13 x 36	600 x 325 x 914	EN_S-H243613TR	1,866	—
	24 x 13 x 30	600 x 325 x 762	EN_S-H243013TL	1,821	—
	24 x 13 x 30	600 x 325 x 762	EN_S-H243013TR	1,821	—
	24 x 13 x 24	600 x 325 x 609	EN_S-H242413TL	1,774	—
	24 x 13 x 24	600 x 325 x 609	EN_S-H242413TR	1,774	—
	18 x 13 x 48	450 x 325 x 1219	EN_S-H184813TL	1,736	—
	18 x 13 x 48	450 x 325 x 1219	EN_S-H184813TR	1,736	—
	18 x 13 x 36	450 x 325 x 914	EN_S-H183613TL	1,700	—
	18 x 13 x 36	450 x 325 x 914	EN_S-H183613TR	1,700	—
	18 x 13 x 30	450 x 325 x 762	EN_S-H183013TL	1,664	—
	18 x 13 x 30	450 x 325 x 762	EN_S-H183013TR	1,664	—
	18 x 13 x 24	450 x 325 x 609	EN_S-H182413TL	1,629	—
	18 x 13 x 24	450 x 325 x 609	EN_S-H182413TR	1,629	—

48"-30" H:  
2 adjustable shelves.  
24" H:  
1 adjustable shelf.  
L at the end of the code: opens left.  
R at the end of the code: opens right.

Specify the handle code (Q, V).

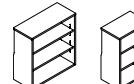
	W x D x H (" )	W x D x H (mm)	Code	All Laminate (\$)	HPL Surfaces (\$)
<b>Open cabinets, 16" D</b>					
	<i>To be used with the Laminate hanging system (sold separately). 1 tone only.</i>				
	36 x 16 x 48	900 x 400 x 1219	ENN_-H364816	1,612	—
	24 x 16 x 48	600 x 400 x 1219	ENN_-H244816	1,551	—
	18 x 16 x 48	450 x 400 x 1219	ENN_-H184816	1,378	—
	36 x 16 x 36	900 x 400 x 914	ENN_-H363616	1,563	—
	24 x 16 x 36	600 x 400 x 914	ENN_-H243616	1,509	—
	18 x 16 x 36	450 x 400 x 914	ENN_-H183616	1,344	—
	36 x 16 x 30	900 x 400 x 762	ENN_-H363016	1,516	—
	24 x 16 x 30	600 x 400 x 762	ENN_-H243016	1,465	—
	18 x 16 x 30	450 x 400 x 762	ENN_-H183016	1,309	—
	36 x 16 x 24	900 x 400 x 609	ENN_-H362416	1,476	—
	24 x 16 x 24	600 x 400 x 609	ENN_-H242416	1,425	—
	18 x 16 x 24	450 x 400 x 609	ENN_-H182416	1,272	—

48" to 30" H:  
2 adjustable shelves.  
24" H:  
1 adjustable shelf.

Specify the accent color (A, S).

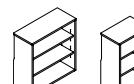
	W x D x H (" )	W x D x H (mm)	Code	All Laminate (\$)	HPL Surfaces (\$)
<b>Open cabinets, 13" D</b>					
	<i>To be used with the Laminate hanging system (sold separately). 1 tone only.</i>				
	36 x 13 x 48	900 x 325 x 1219	ENN_-H364813	1,595	—
	24 x 13 x 48	600 x 325 x 1219	ENN_-H244813	1,535	—
	18 x 13 x 48	450 x 325 x 1219	ENN_-H184813	1,358	—
	36 x 13 x 36	900 x 325 x 914	ENN_-H363613	1,542	—
	24 x 13 x 36	600 x 325 x 914	ENN_-H243613	1,491	—
	18 x 13 x 36	450 x 325 x 914	ENN_-H183613	1,325	—
	36 x 13 x 30	900 x 325 x 762	ENN_-H363013	1,497	—
	24 x 13 x 30	600 x 325 x 762	ENN_-H243013	1,444	—
	18 x 13 x 30	450 x 325 x 762	ENN_-H183013	1,291	—
	36 x 13 x 24	900 x 325 x 609	ENN_-H362413	1,455	—
	24 x 13 x 24	600 x 325 x 609	ENN_-H242413	1,404	—
	18 x 13 x 24	450 x 325 x 609	ENN_-H182413	1,255	—

48" to 30" H:  
2 adjustable shelves.  
24" H:  
1 adjustable shelf.

Specify the accent color (A, S).

W x D x H (")	W x D x H (mm)	Code	All Laminate (\$)	HPL Surfaces (\$)
---------------	----------------	------	-------------------	-------------------

**SHELVINGS**

Thermofused laminate frame. Levelers with 1½" (38 mm) height adjustment. Shelves: 18-gauge steel, Anthracite grey paint, load capacity 150 lbs (86 kg). Anti-tip shelves can be individually positioned flat or angled at 45° for display. Shelves are packaged separately.

**Single-sided shelvings - open back**

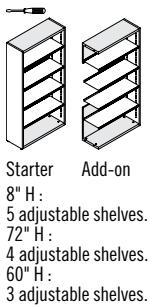

*Single-faced shelvings must be anchored to a wall for safety and stability.*

**Starter**

37 x 14 x 84	925 x 344 x 2130	E5NN-BOS143784	2,194	-
37 x 14 x 72	925 x 344 x 1825	E5NN-BOS143772	1,988	-
37 x 14 x 60	925 x 344 x 1520	E5NN-BOS143760	1,743	-
30 x 14 x 84	750 x 344 x 2130	E5NN-BOS143084	2,142	-
30 x 14 x 72	750 x 344 x 1825	E5NN-BOS143072	1,947	-
30 x 14 x 60	750 x 344 x 1520	E5NN-BOS143060	1,712	-

**Add-on**

*Height must be equal to the starter unit.*

36 x 14 x 84	900 x 344 x 2130	E5NN-BOA143684	2,022	-
36 x 14 x 72	900 x 344 x 1825	E5NN-BOA143672	1,805	-
36 x 14 x 60	900 x 344 x 1520	E5NN-BOA143660	1,535	-
29 x 14 x 84	725 x 344 x 2129	E5NN-BOA142984	1,970	-
29 x 14 x 72	725 x 344 x 1825	E5NN-BOA142972	1,764	-
29 x 14 x 60	725 x 344 x 1520	E5NN-BOA142960	1,504	-

**Single-sided shelvings - closed back**

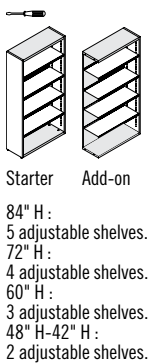

*Single-faced shelvings must be anchored to a wall for safety and stability.*

**Starter**

37 x 14 x 84	925 x 344 x 2130	E5NN-BCS143784	2,424	-
37 x 14 x 72	925 x 344 x 1825	E5NN-BCS143772	2,205	-
37 x 14 x 60	925 x 344 x 1520	E5NN-BCS143760	1,910	-
37 x 14 x 48	925 x 344 x 1215	E5NN-BCS143748	1,509	-
37 x 14 x 42	925 x 344 x 1063	E5NN-BCS143742	1,378	-
30 x 14 x 84	750 x 344 x 2130	E5NN-BCS143084	2,372	-
30 x 14 x 72	750 x 344 x 1825	E5NN-BCS143072	2,163	-
30 x 14 x 60	750 x 344 x 1520	E5NN-BCS143060	1,879	-
30 x 14 x 48	750 x 344 x 1215	E5NN-BCS143048	1,488	-
30 x 14 x 42	750 x 344 x 1063	E5NN-BCS143042	1,357	-

**Add-on**

*Height must be equal to the starter unit.*

36 x 14 x 84	900 x 344 x 2130	E5NN-BCA143684	2,194	-
36 x 14 x 72	900 x 344 x 1825	E5NN-BCA143672	1,962	-
36 x 14 x 60	900 x 344 x 1520	E5NN-BCA143660	1,655	-
36 x 14 x 48	900 x 344 x 1215	E5NN-BCA143648	1,358	-
36 x 14 x 42	900 x 344 x 1063	E5NN-BCA143642	1,272	-
29 x 14 x 84	725 x 344 x 2129	E5NN-BCA142984	2,142	-
29 x 14 x 72	725 x 344 x 1825	E5NN-BCA142972	1,921	-
29 x 14 x 60	725 x 344 x 1520	E5NN-BCA142960	1,623	-
29 x 14 x 48	725 x 344 x 1215	E5NN-BCA142948	1,337	-
29 x 14 x 42	725 x 344 x 1063	E5NN-BCA142942	1,251	-

**Double-sided shelvings - open back**

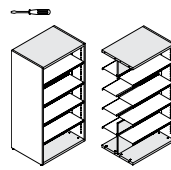

Starter Add-on  
84" H :  
10 adjustables shelves.  
72" H :  
8 adjustables shelves.  
60" H :  
6 adjustables shelves.

**Starter**

37 x 26 x 84	925 x 665 x 2130	E5NN-BOS263784	3,730	-
37 x 26 x 72	925 x 665 x 1825	E5NN-BOS263772	3,277	-
37 x 26 x 60	925 x 665 x 1520	E5NN-BOS263760	2,828	-
30 x 26 x 84	750 x 665 x 2130	E5NN-BOS263084	3,626	-
30 x 26 x 72	750 x 665 x 1825	E5NN-BOS263072	3,194	-
30 x 26 x 60	750 x 665 x 1520	E5NN-BOS263060	2,765	-

**Add-on**

*Height must be equal to the starter unit.*

36 x 26 x 84	900 x 665 x 2130	E5NN-BOA263684	3,342	-
36 x 26 x 72	900 x 665 x 1825	E5NN-BOA263672	2,946	-
36 x 26 x 60	900 x 665 x 1520	E5NN-BOA263660	2,554	-
29 x 26 x 84	725 x 665 x 2129	E5NN-BOA262984	3,238	-
29 x 26 x 72	725 x 665 x 1825	E5NN-BOA262972	2,863	-
29 x 26 x 60	725 x 665 x 1520	E5NN-BOA262960	2,492	-

**Double-sided shelvings - closed back**

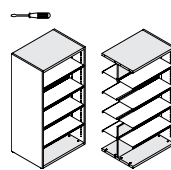

Starter Add-on  
84" H :  
10 adjustables shelves.  
72" H :  
8 adjustables shelves.  
60" H :  
6 adjustables shelves.  
48" H-42" H :  
4 adjustables shelves.

**Starter**

37 x 26 x 84	925 x 665 x 2130	E5NN-BCS263784	3,851	-
37 x 26 x 72	925 x 665 x 1825	E5NN-BCS263772	3,400	-
37 x 26 x 60	925 x 665 x 1520	E5NN-BCS263760	2,886	-
37 x 26 x 48	925 x 665 x 1215	E5NN-BCS263748	2,441	-
37 x 26 x 42	925 x 665 x 1063	E5NN-BCS263742	2,319	-
30 x 26 x 84	750 x 665 x 2130	E5NN-BCS263084	3,799	-
30 x 26 x 72	750 x 665 x 1825	E5NN-BCS263072	3,348	-
30 x 26 x 60	750 x 665 x 1520	E5NN-BCS263060	2,834	-
30 x 26 x 48	750 x 665 x 1215	E5NN-BCS263048	2,389	-
30 x 26 x 42	750 x 665 x 1063	E5NN-BCS263042	2,267	-

**Add-on**

*Height must be equal to the starter unit.*

36 x 26 x 84	900 x 665 x 2130	E5NN-BCA263684	3,460	-
36 x 26 x 72	900 x 665 x 1825	E5NN-BCA263672	3,049	-
36 x 26 x 60	900 x 665 x 1520	E5NN-BCA263660	2,597	-
36 x 26 x 48	900 x 665 x 1215	E5NN-BCA263648	2,144	-
36 x 26 x 42	900 x 665 x 1063	E5NN-BCA263642	2,035	-
29 x 26 x 84	725 x 665 x 2129	E5NN-BCA262984	3,408	-
29 x 26 x 72	725 x 665 x 1825	E5NN-BCA262972	2,997	-
29 x 26 x 60	725 x 665 x 1520	E5NN-BCA262960	2,545	-
29 x 26 x 48	725 x 665 x 1215	E5NN-BCA262948	2,092	-
29 x 26 x 42	725 x 665 x 1063	E5NN-BCA262942	1,983	-

**Additional shelf**

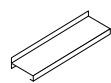

*Anthracite grey 18-gauge steel with anti-tip device. Shelf can be positioned flat or angled for display.*

35 x 12 x 2	873 x 308 x 51	ENNN-BSHM36	173	-
28 x 12 x 2	697 x 308 x 51	ENNN-BSHM30	121	-

**Wire supports for books**

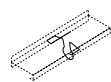

*Steel. Installs under the shelves.*

*Package of 2.*

8 ½ x 13 x 9	210 x 330 x 225	ENNN-BDIVM2	147	-
<i>Package of 10.</i>				
8 ½ x 13 x 9	210 x 330 x 225	ENNN-BDIVM10	443	-

**Mobile book cart**



*2 double-faced slanted shelves. 1 fixed flat shelf. 4 swivel casters, 2 with brakes. Lower and middle shelf clearance 10 ½".*

30 x 18 x 36	750 x 450 x 911	ENN_-MA183036	2,035	-
--------------	-----------------	---------------	-------	---

**Specify the accent color (A, S).**

**CIRCULATION DESKS – 39" H**

Full height 2-tone modesty panel. Levelers with 1½" (38 mm) height adjustment. All side panels come with wire access unless otherwise specified. End panel (ENNN-GFP2839) may be required to complete a circulation desk layout.

Rectangular counters	W x D x H (")	W x D x H (mm)	Code	All Laminate (\$)	HPL Surfaces (\$)
	84 x 28 x 39	2100 x 700 x 987	E_N_-G288439	1,563	1,805
	78 x 28 x 39	1950 x 700 x 987	E_N_-G287839	1,516	1,761
	72 x 28 x 39	1800 x 700 x 987	E_N_-G287239	1,465	1,700
	66 x 28 x 39	1650 x 700 x 987	E_N_-G286639	1,437	1,664
	60 x 28 x 39	1500 x 700 x 987	E_N_-G286039	1,412	1,642
	54 x 28 x 39	1350 x 700 x 987	E_N_-G285439	1,378	1,595

Surface grommet option, add H at the end of the code. 84" to 48": 2 grommets. 42" to 36": 1 grommet.

84" to 78": Packaged in 2 boxes.

Specify the surface type (1, 2). Grommet option, specify the accent color (A, S) or specify N for no grommet.

	84 x 28 x 39½	2100 x 700 x 1000	E_N_-G288439	1,664	1,925
	78 x 28 x 39½	1950 x 700 x 1000	E_N_-G287839	1,621	1,880
	72 x 28 x 39½	1800 x 700 x 1000	E_N_-G287239	1,587	1,841
	66 x 28 x 39½	1650 x 700 x 1000	E_N_-G286639	1,542	1,795
	60 x 28 x 39½	1500 x 700 x 1000	E_N_-G286039	1,509	1,743
	54 x 28 x 39½	1350 x 700 x 1000	E_N_-G285439	1,455	1,692
	48 x 28 x 39½	1200 x 700 x 1000	E_N_-G284839	1,430	1,655
	42 x 28 x 39½	1050 x 700 x 1000	E_N_-G284239	1,395	1,621
	36 x 28 x 39½	900 x 700 x 1000	E_N_-G283639	1,368	1,587

Specify the surface type (5, 6). Grommet option, specify the accent color (A, S) or specify N for no grommet.

Bow front counters	W x D x H (")	W x D x H (mm)	Code	All Laminate (\$)	HPL Surfaces (\$)
	84 x 31 x 39	2100 x 775 x 987	E_N_-G288439A	1,805	2,091
	78 x 31 x 39	1950 x 775 x 987	E_N_-G287839A	1,761	2,047
	72 x 31 x 39	1800 x 775 x 987	E_N_-G287239A	1,700	1,978
	66 x 31 x 39	1650 x 775 x 987	E_N_-G286639A	1,664	1,925
	60 x 31 x 39	1500 x 775 x 987	E_N_-G286039A	1,642	1,903
	54 x 31 x 39	1350 x 775 x 987	E_N_-G285439A	1,595	1,848

Surface grommet option, add H at the end of the code. 84" to 48": 2 grommets. 42" to 36": 1 grommet.

84" to 78": Packaged in 2 boxes.

Specify the surface type (1, 2). Grommet option, specify the accent color (A, S) or specify N for no grommet.

	84 x 31 x 39½	2100 x 775 x 1000	E_N_-G288439A	1,925	2,240
	78 x 31 x 39½	1950 x 775 x 1000	E_N_-G287839A	1,880	2,187
	72 x 31 x 39½	1800 x 775 x 1000	E_N_-G287239A	1,841	2,135
	66 x 31 x 39½	1650 x 775 x 1000	E_N_-G286639A	1,795	2,075
	60 x 31 x 39½	1500 x 775 x 1000	E_N_-G286039A	1,743	2,022
	54 x 31 x 39½	1350 x 775 x 1000	E_N_-G285439A	1,692	1,970
	48 x 31 x 39½	1200 x 775 x 1000	E_N_-G284839A	1,655	1,917
	42 x 31 x 39½	1050 x 775 x 1000	E_N_-G284239A	1,621	1,880
	36 x 31 x 39½	900 x 775 x 1000	E_N_-G283639A	1,587	1,841

Specify the surface type (5, 6). Grommet option, specify the accent color (A, S) or specify N for no grommet.

**Reception desks**

Reception desks	W x D x H (")	W x D x H (mm)	Code	All Laminate (\$)	HPL Surfaces (\$)
	84 x 28 x 39	2100 x 700 x 987	E_N_-GS2884H	1,789	2,022
	78 x 28 x 39	1950 x 700 x 987	E_N_-GS2878H	1,743	1,978
	72 x 28 x 39	1800 x 700 x 987	E_N_-GS2872H	1,700	1,925
	66 x 28 x 39	1650 x 700 x 987	E_N_-GS2866H	1,672	1,892
	60 x 28 x 39	1500 x 700 x 987	E_N_-GS2860H	1,649	1,866
	54 x 28 x 39	1350 x 700 x 987	E_N_-GS2854H	1,612	1,821
	48 x 28 x 39	1200 x 700 x 987	E_N_-GS2848H	1,587	1,795
	42 x 28 x 39	1050 x 700 x 987	E_N_-GS2842H	1,563	1,753
	36 x 28 x 39	900 x 700 x 987	E_N_-GS2836H	1,526	1,727

9" (228 mm) deep transaction shelf. Grommet.  
 84" to 48": 2 grommets. 42" to 36": 1 grommet.  
 84" to 54": Packaged in 2 boxes.

Specify the surface type (1, 2). Specify the accent color (A, S).

	84 x 28 x 39½	2100 x 700 x 1000	E_N_-GS2884H	1,892	2,144
	78 x 28 x 39½	1950 x 700 x 1000	E_N_-GS2878H	1,848	2,101
	72 x 28 x 39½	1800 x 700 x 1000	E_N_-GS2872H	1,813	2,059
	66 x 28 x 39½	1650 x 700 x 1000	E_N_-GS2866H	1,768	2,016
	60 x 28 x 39½	1500 x 700 x 1000	E_N_-GS2860H	1,736	1,962
	54 x 28 x 39½	1350 x 700 x 1000	E_N_-GS2854H	1,692	1,917
	48 x 28 x 39½	1200 x 700 x 1000	E_N_-GS2848H	1,664	1,880
	42 x 28 x 39½	1050 x 700 x 1000	E_N_-GS2842H	1,642	1,848
	36 x 28 x 39½	900 x 700 x 1000	E_N_-GS2836H	1,603	1,813

Specify the surface type (5, 6). Specify the accent color (A, S).

**Reception desks, bow transaction shelf**

Reception desks, bow transaction shelf	W x D x H (")	W x D x H (mm)	Code	All Laminate (\$)	HPL Surfaces (\$)
	84 x 31 x 39	2100 x 775 x 987	E_N_-GS2884AH	1,917	2,172
	78 x 31 x 39	1950 x 775 x 987	E_N_-GS2878AH	1,873	2,128
	72 x 31 x 39	1800 x 775 x 987	E_N_-GS2872AH	1,828	2,075
	66 x 31 x 39	1650 x 775 x 987	E_N_-GS2866AH	1,805	2,030
	60 x 31 x 39	1500 x 775 x 987	E_N_-GS2860AH	1,768	1,998
	54 x 31 x 39	1350 x 775 x 987	E_N_-GS2854AH	1,736	1,962
	48 x 31 x 39	1200 x 775 x 987	E_N_-GS2848AH	1,700	1,925
	42 x 31 x 39	1050 x 775 x 987	E_N_-GS2842AH	1,672	1,880
	36 x 31 x 39	900 x 775 x 987	E_N_-GS2836AH	1,649	1,848

13" (330 mm) deep bow front transaction shelf. Grommet.  
 84" to 48": 2 grommets. 42" to 36": 1 grommet.  
 84" to 54": Packaged in 2 boxes.

Specify the surface type (1, 2). Specify the accent color (A, S).

	84 x 31 x 39½	2100 x 775 x 1000	E_N_-GS2884AH	2,030	2,303
	78 x 31 x 39½	1950 x 775 x 1000	E_N_-GS2878AH	1,988	2,257
	72 x 31 x 39½	1800 x 775 x 1000	E_N_-GS2872AH	1,953	2,214
	66 x 31 x 39½	1650 x 775 x 1000	E_N_-GS2866AH	1,910	2,151
	60 x 31 x 39½	1500 x 775 x 1000	E_N_-GS2860AH	1,866	2,109
	54 x 31 x 39½	1350 x 775 x 1000	E_N_-GS2854AH	1,821	2,065
	48 x 31 x 39½	1200 x 775 x 1000	E_N_-GS2848AH	1,795	2,022
	42 x 31 x 39½	1050 x 775 x 1000	E_N_-GS2842AH	1,753	1,988
	36 x 31 x 39½	900 x 775 x 1000	E_N_-GS2836AH	1,727	1,953

Specify the surface type (5, 6). Specify the accent color (A, S).

CIRCULATION DESKS – 29" H

Full height 2-tone modesty panel. Levelers with 1½" (38 mm) height adjustment. All side panels come with wire access unless otherwise specified. End panel (ENNN-GFP2829) may be required to complete a circulation desk layout.

Rectangular counters	W x D x H (")	W x D x H (mm)	Code	All Laminate (\$)	HPL Surfaces (\$)
	84 x 28 x 29	2100 x 700 x 735	E_N_-G288429	1,491	1,727
	78 x 28 x 29	1950 x 700 x 735	E_N_-G287829	1,444	1,684
	72 x 28 x 29	1800 x 700 x 735	E_N_-G287229	1,412	1,642
	66 x 28 x 29	1650 x 700 x 735	E_N_-G286629	1,378	1,595
	60 x 28 x 29	1500 x 700 x 735	E_N_-G286029	1,351	1,570
	54 x 28 x 29	1350 x 700 x 735	E_N_-G285429	1,319	1,526
	48 x 28 x 29	1200 x 700 x 735	E_N_-G284829	1,291	1,497
	42 x 28 x 29	1050 x 700 x 735	E_N_-G284229	1,265	1,455
	36 x 28 x 29	900 x 700 x 735	E_N_-G283629	1,231	1,430

Specify the surface type (1, 2). Grommet option, specify the accent color (A, S) or specify N for no grommet.

	84 x 28 x 29½	2100 x 700 x 748	E_N_-G288429	1,595	1,848
	78 x 28 x 29½	1950 x 700 x 748	E_N_-G287829	1,563	1,805
	72 x 28 x 29½	1800 x 700 x 748	E_N_-G287229	1,516	1,761
	66 x 28 x 29½	1650 x 700 x 748	E_N_-G286629	1,483	1,714
	60 x 28 x 29½	1500 x 700 x 748	E_N_-G286029	1,437	1,664
	54 x 28 x 29½	1350 x 700 x 748	E_N_-G285429	1,395	1,621
	48 x 28 x 29½	1200 x 700 x 748	E_N_-G284829	1,368	1,587
	42 x 28 x 29½	1050 x 700 x 748	E_N_-G284229	1,344	1,563
	36 x 28 x 29½	900 x 700 x 748	E_N_-G283629	1,309	1,516

Specify the surface type (5, 6). Grommet option, specify the accent color (A, S) or specify N for no grommet.

Bow front counters	W x D x H (")	W x D x H (mm)	Code	All Laminate (\$)	HPL Surfaces (\$)
	84 x 31 x 29	2100 x 775 x 735	E_N_-G288429A	1,727	1,998
	78 x 31 x 29	1950 x 775 x 735	E_N_-G287829A	1,684	1,953
	72 x 31 x 29	1800 x 775 x 735	E_N_-G287229A	1,642	1,903
	66 x 31 x 29	1650 x 775 x 735	E_N_-G286629A	1,595	1,848
	60 x 31 x 29	1500 x 775 x 735	E_N_-G286029A	1,570	1,813
	54 x 31 x 29	1350 x 775 x 735	E_N_-G285429A	1,526	1,768
	48 x 31 x 29	1200 x 775 x 735	E_N_-G284829A	1,497	1,736
	42 x 31 x 29	1050 x 775 x 735	E_N_-G284229A	1,455	1,692
	36 x 31 x 29	900 x 775 x 735	E_N_-G283629A	1,430	1,655

Specify the surface type (1, 2). Grommet option, specify the accent color (A, S) or specify N for no grommet.

	84 x 31 x 29½	2100 x 775 x 748	E_N_-G288429A	1,848	2,144
	78 x 31 x 29½	1950 x 775 x 748	E_N_-G287829A	1,805	2,091
	72 x 31 x 29½	1800 x 775 x 748	E_N_-G287229A	1,761	2,047
	66 x 31 x 29½	1650 x 775 x 748	E_N_-G286629A	1,714	1,988
	60 x 31 x 29½	1500 x 775 x 748	E_N_-G286029A	1,664	1,925
	54 x 31 x 29½	1350 x 775 x 748	E_N_-G285429A	1,621	1,880
	48 x 31 x 29½	1200 x 775 x 748	E_N_-G284829A	1,587	1,841
	42 x 31 x 29½	1050 x 775 x 748	E_N_-G284229A	1,563	1,805
	36 x 31 x 29½	900 x 775 x 748	E_N_-G283629A	1,516	1,761

Specify the surface type (5, 6). Grommet option, specify the accent color (A, S) or specify N for no grommet.

End panels	W x D x H (")	W x D x H (mm)	Code	All Laminate (\$)	HPL Surfaces (\$)
	1 x 28 x 42	25 x 700 x 1065	ENNN-GFP2839	375	-
	1 x 28 x 32	25 x 700 x 815	ENNN-GFP2829	349	-



All Laminate (\$)  
HPL Surfaces (\$)

All Laminate (\$)  
HPL Surfaces (\$)

ADA rectangular counters, 32" H



W x D x H (")	W x D x H (mm)	Code	All Laminate (\$)	HPL Surfaces (\$)
36 x 28 x 32	900 x 700 x 813	E_NN-G283632	986	1,140

Specify the surface type (1, 2).

36 x 28 x 32½	900 x 700 x 826	E_NN-G283632	1,038	1,205
---------------	-----------------	--------------	-------	-------

Specify the surface type (5, 6).

ADA bow front counters, 32" H



W x D x H (")	W x D x H (mm)	Code	All Laminate (\$)	HPL Surfaces (\$)
36 x 31 x 32	900 x 775 x 813	E_NN-G283632A	1,133	1,291

Specify the surface type (1, 2).

36 x 31 x 32½	900 x 775 x 826	E_NN-G283632A	1,186	1,351
---------------	-----------------	---------------	-------	-------

Specify the surface type (5, 6).

Corner bookcase units, 39" H



W x D x H (")	W x D x H (mm)	Code	All Laminate (\$)	HPL Surfaces (\$)
28 x 28 x 39	700 x 700 x 987	E1NN-GB282839	1,425	-

1" (25 mm) thick laminate top.

28 x 28 x 39½	700 x 700 x 1000	E5NN-GB282839	1,483	-
---------------	------------------	---------------	-------	---

1½" (38 mm) thick laminate top.

Corner bookcase units, 29" H



W x D x H (")	W x D x H (mm)	Code	All Laminate (\$)	HPL Surfaces (\$)
28 x 28 x 29	700 x 700 x 735	E1NN-GB282829	1,219	-

1" (25 mm) thick laminate top.

28 x 28 x 29½	700 x 700 x 748	E5NN-GB282829	1,278	-
---------------	-----------------	---------------	-------	---

1½" (38 mm) thick laminate top.

CIRCULATION DESK STORAGE UNITS – 39" H

Full height 2-tone modesty panel. Levelers with 1½" (38 mm) height adjustment. All side panels come with wire access unless otherwise specified. End panels (ENNN-GFP2839) may be required to complete a circulation desk layout.

Bookcase units with doors

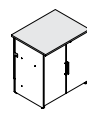

W x D x H (")	W x D x H (mm)	Code	All Laminate (\$)	HPL Surfaces (\$)
36 x 28 x 39	900 x 700 x 987	E___-G283639B	1,925	2,016

Specify the surface type (1, 2). Specify the handle code (L, Q, V). Specify the accent color (A, S).

36 x 28 x 39½	900 x 700 x 1000	E___-G283639B	2,022	2,101
---------------	------------------	---------------	-------	-------

Specify the surface type (5, 6). Specify the handle code (L, Q, V). Specify the accent color (A, S).

Combined storage units

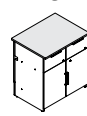

W x D x H (")	W x D x H (mm)	Code	All Laminate (\$)	HPL Surfaces (\$)
36 x 28 x 39	900 x 700 x 987	E___-G283639T	2,266	2,352

Specify the surface type (1, 2). Specify the handle code (L, Q, V). Specify the accent color (A, S).

36 x 28 x 39½	900 x 700 x 1000	E___-G283639T	2,362	2,467
---------------	------------------	---------------	-------	-------

Specify the surface type (5, 6). Specify the handle code (L, Q, V). Specify the accent color (A, S).

Combined storage units

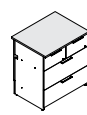





W x D x H (")	W x D x H (mm)	Code	All Laminate (\$)	HPL Surfaces (\$)
36 x 28 x 39	900 x 700 x 987	E___-G283639U	2,927	3,049

Specify the surface type (1, 2). Specify the handle code (L, Q, V). Specify the accent color (A, S).





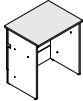
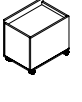

36 x 28 x 39½	900 x 700 x 1000	E___-G283639U	2,973	3,113
---------------	------------------	---------------	-------	-------

Specify the surface type (5, 6). Specify the handle code (L, Q, V). Specify the accent color (A, S).

	W x D x H (")	W x D x H (mm)	Code	All Laminate (\$)	HPL Surfaces (\$)
<b>Open combined storage units</b> 	<i>1 open storage. 33 3/8" W x 23" D x 9 3/4" H (847 x 582 x 248 mm). 3 box drawers. 1 lateral file drawer with suspension bars. Locks.</i>				
	36 x 28 x 39	900 x 700 x 987	E___-GC283639	3,041	3,173
	Specify the surface type (1, 2). Specify the handle code (L, Q, V). Specify the accent color (A, S).				
	36 x 28 x 39 1/2	900 x 700 x 1000	E___-GC283639	3,103	3,235
	Specify the surface type (5, 6). Specify the handle code (L, Q, V). Specify the accent color (A, S).				
<b>Open lateral file units</b> 	<i>1 open storage. 33 3/8" W x 23" D x 9 3/4" H (847 x 582 x 248 mm). 2 lateral file drawers with suspension bars. Interlock system. Lock.</i>				
	36 x 28 x 39	900 x 700 x 987	E___-GL283639	2,257	2,370
	Specify the surface type (1, 2). Specify the handle code (L, Q, V). Specify the accent color (A, S).				
	36 x 28 x 39 1/2	900 x 700 x 1000	E___-GL283639	2,303	2,441
	Specify the surface type (5, 6). Specify the handle code (L, Q, V). Specify the accent color (A, S).				
<b>Storage units with drawers</b> 	<i>4 utility drawers. Interlock system. Lock.</i>				
	36 x 28 x 39	900 x 700 x 987	E___-GU283639	2,737	2,787
	Specify the surface type (1, 2). Specify the handle code (L, Q, V). Specify the accent color (A, S).				
	36 x 28 x 39 1/2	900 x 700 x 1000	E___-GU283639	2,860	2,927
	Specify the surface type (5, 6). Specify the handle code (L, Q, V). Specify the accent color (A, S).				
<b>Bookcase units</b> 	<i>2 adjustable shelves.</i>				
	36 x 28 x 39	900 x 700 x 987	E_NN-GB283639	1,672	1,795
	Specify the surface type (1, 2).				
	36 x 28 x 39 1/2	900 x 700 x 1000	E_NN-GB283639	1,727	1,866
	Specify the surface type (5, 6).				
<b>Lateral file units</b> 	<i>1 box drawer. 2 lateral file drawers with suspension bars. Interlock system. Lock.</i>				
	36 x 28 x 39	900 x 700 x 987	E___-GW283639	2,776	2,879
	Specify the surface type (1, 2). Specify the handle code (L, Q, V). Specify the accent color (A, S).				
	36 x 28 x 39 1/2	900 x 700 x 1000	E___-GW283639	2,894	3,014
	Specify the surface type (5, 6). Specify the handle code (L, Q, V). Specify the accent color (A, S).				
<b>Book return units</b> 	<i>Book slot opening: 14" W x 4" H (355 x 102 mm). Interior space: 33 1/4" W x 23" D x 37" H (847 x 582 x 940 mm).</i>				
	36 x 28 x 39	900 x 700 x 987	E_NN-GD283639	1,437	1,649
	Specify the surface type (1, 2).				
	36 x 28 x 39 1/2	900 x 700 x 1000	E_NN-GD283639	1,516	1,736
	Specify the surface type (5, 6).				
<b>Depressible book cart</b> 	<i>4 swivel casters, 2 with brakes. 1 tone only.</i>				
	31 x 22 x 29 1/2	790 x 560 x 749	ENNN-GDBOX30	3,156	-

CIRCULATION DESK STORAGE UNITS – 29" H



Full height 2-tone modesty panel. Levelers with 1 1/2" (38 mm) height adjustment. All side panels come with wire access unless otherwise specified. End panels (ENNN-GFP2829) may be required to complete a circulation desk layout.

	W x D x H (")	W x D x H (mm)	Code	All Laminate (\$)	HPL Surfaces (\$)
<b>Bookcase units with doors</b> 	<i>1 adjustable shelf. Lock.</i>				
	36 x 28 x 29	900 x 700 x 735	E___-G283629B	1,649	1,714
	Specify the surface type (1, 2). Specify the handle code (L, Q, V). Specify the accent color (A, S).				
	36 x 28 x 29 1/2	900 x 700 x 748	E___-G283629B	1,727	1,795
	Specify the surface type (5, 6). Specify the handle code (L, Q, V). Specify the accent color (A, S).				
<b>Combined storage units</b> 	<i>2 box drawers. Bookcase with doors, 1 adjustable shelf. Locks.</i>				
	36 x 28 x 29	900 x 700 x 735	E___-G283629T	2,075	2,151
	Specify the surface type (1, 2). Specify the handle code (L, Q, V). Specify the accent color (A, S).				
	36 x 28 x 29 1/2	900 x 700 x 748	E___-G283629T	2,172	2,257
	Specify the surface type (5, 6). Specify the handle code (L, Q, V). Specify the accent color (A, S).				
<b>Combined storage units</b> 	<i>3 box drawers. 1 lateral file drawer with suspension bars. Locks.</i>				
	36 x 28 x 29	900 x 700 x 735	E___-GC283629	2,747	2,879
	Specify the surface type (1, 2). Specify the handle code (L, Q, V). Specify the accent color (A, S).				
	36 x 28 x 29 1/2	900 x 700 x 748	E___-GC283629	2,806	2,938
	Specify the surface type (5, 6). Specify the handle code (L, Q, V). Specify the accent color (A, S).				
<b>Lateral file units</b> 	<i>2 lateral file drawers with suspension bars. Interlock system. Lock.</i>				
	36 x 28 x 29	900 x 700 x 735	E___-GL283629	1,962	2,091
	Specify the surface type (1, 2). Specify the handle code (L, Q, V). Specify the accent color (A, S).				
	36 x 28 x 29 1/2	900 x 700 x 748	E___-GL283629	2,022	2,144
	Specify the surface type (5, 6). Specify the handle code (L, Q, V). Specify the accent color (A, S).				
<b>Storage units with drawers</b> 	<i>4 utility drawers. Lock.</i>				
	36 x 28 x 29	900 x 700 x 735	E___-GU283629	2,597	2,720
	Specify the surface type (1, 2). Specify the handle code (L, Q, V). Specify the accent color (A, S).				
	36 x 28 x 29 1/2	900 x 700 x 748	E___-GU283629	2,649	2,787
	Specify the surface type (5, 6). Specify the handle code (L, Q, V). Specify the accent color (A, S).				
<b>Bookcase units</b> 	<i>1 adjustable shelf.</i>				
	36 x 28 x 29	900 x 700 x 735	E_NN-GB283629	1,509	1,612
	Specify the surface type (1, 2).				
	36 x 28 x 29 1/2	900 x 700 x 748	E_NN-GB283629	1,563	1,672
	Specify the surface type (5, 6).				

BENCHES

Rectangular laminate benches					
	<i>Open storage space. Silver anodized aluminum feet. Can accommodate a cushion, order separately.</i>				
	48 x 20 x 20	1200 x 500 x 508	E1NS-BCH2048	899	-
	36 x 20 x 20	900 x 500 x 508	E1NS-BCH2036	842	-
	24 x 20 x 20	600 x 500 x 508	E1NS-BCH2024	724	-

# EDUCATIONAL FURNITURE

	W x D x H (*)	W x D x H (mm)	Code	All Laminate (\$)	HPL Surfaces (\$)
<b>Corner laminate bench</b>	<i>Open storage space. Silver anodized aluminum feet. Must be attached to a rectangular laminate bench (E1NS-BCH20_ _).</i>				
	20 x 20 x 20	500 x 500 x 508	E1NS-BQR2020	691	-
<b>Laminate magazine table</b>	<i>Open storage space. Silver anodized aluminum feet.</i>				
	36 x 36 x 20	900 x 900 x 508	E1NS-STR3620	1,133	-
<b>Cushions</b>	<i>Installs on rectangular benches seat with Velcro. These prices are applicable for United Chair® Grade 1 and 2 standard fabrics. For other grades add: Grade 3: 15%, Grade 4: 20%, Grade 5: 25% and Grade 6: 30%.</i>				
	48 x 20 x 1 3/8	1200 x 500 x 35	ENNN-CU2048	742	-
All United Chair® standard fabrics, vinyls and leathers are available to coordinate on cushions.	36 x 20 x 1 3/8	900 x 500 x 35	ENNN-CU2036	560	-
	24 x 20 x 1 3/8	600 x 500 x 35	ENNN-CU2024	402	-
<b>Specify the fabric code after the product code.</b>					

## LOCKERS

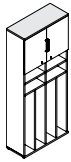
<b>Storage cubbies with doors</b>	<i>1 adjustable shelf. 8 hooks for clothes. Locks. Levelers with 1/2" (38 mm) height adjustment. Single-faced shelvings must be anchored to a wall for safety and stability.</i>				
	36 x 15 x 84	900 x 375 x 2130	E1_ _-L153684P	2,787	-
<b>Specify the handle code (L, Q, V). Specify the accent color (A, S).</b>					

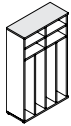
<b>Open storage cubbies</b>	<i>8 hooks for clothes. Levelers with 1/2" (38 mm) height adjustment.</i>				
	36 x 15 x 60	900 x 375 x 1520	E1NN-L153660	2,135	-

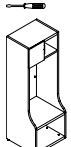
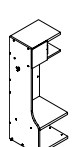
<b>Athletic lockers</b>	<i>Open storage space. 1 door. 1/2" (38 mm) thick integrated seat in thermofused laminate or high-pressure laminate. 2 hooks for clothes. Lock attachment included. Levelers with 1/2" (38 mm) height adjustment. 1 tone only.</i>				
	<b>Starter</b>				
Starter	25 x 24 x 72	625 x 600 x 1825	E_N_ _-OLS2572P	2,378	2,478
	<b>Add-on</b>				
Add-on	24 x 24 x 72	600 x 600 x 1825	E_N_ _-OLA2472P	1,931	1,998
<b>Specify the surface type (5,6). Specify the accent color (A, S).</b>					

## ACCESSORIES

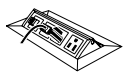
<b>Electrical/communication module</b>	<i>Includes two electrical outlets. Can accommodate the couplers listed on page 177 of the Lacasse general list. 72" (1829 mm) cord included. Silver anodized aluminum. Field installed. UL and CUL certified. Adaptors included.</i>				
	8 1/4 x 4 3/8 x 3	212 x 110 x 75	LGC-PC2P	609	-

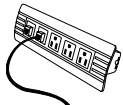
<b>Removable electrical/communication module</b>	<i>3 electrical outlets. Can accommodate the couplers listed on page 177 of the Lacasse general list. 72" cord included. Silver anodized aluminum. UL and CUL certified.</i>				
	10 x 5 1/2 x 3	255 x 140 x 75	LGC-PCS	539	-

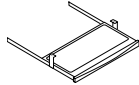
	W x D x H (*)	W x D x H (mm)	Code	All Laminate (\$)	HPL Surfaces (\$)
<b>Sliding keyboard trays</b>	<i>Molded plastic on wood. Height adjustment 3", 3 1/2", 4" (76, 89, 102 mm). Locks in extended position.</i>				
	28 3/8 x 15 x 3 1/2	721 x 381 x 89	LGC-SKD27	306	-

<b>Horizontal wire channels</b>	<i>Self-adhesive. Installs under the surface. Supports most power bars. Specify the plastic finish S Silver or A Anthracite grey.</i>				
	20 x 2 1/4 x 3 3/4	500 x 70 x 80	LGC-HWMC24_	119	-
	44 x 2 1/4 x 3 3/4	1100 x 70 x 80	LGC-HWMC48_	147	-
	68 x 2 1/4 x 3 3/4	1700 x 70 x 80	LGC-HWMC72_	173	-

<b>CPU holder</b>	<i>Black metal CPU support. Mounts under a surface. Hardware included. Adjusts to CPU.</i>				
	5 1/2 x 10 x 15	140 x 250 x 375	LGC-CCPU	254	-

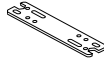
<b>Flush plates</b>	<i>To link and level two surfaces. Package of 10. Black metal.</i>				
	7 x 1 1/2 x 1/8	175 x 38 x 3	LGC-FLP	97	-

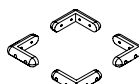
<b>Protective rubber bumpers</b>	<i>For mobile units. Package of 4. Grey.</i>				
	3 7/8 x 3 3/8 x 1	76 x 76 x 25	LGC-BUMP	97	-

## ELECTRIFICATION

<b>Duplex receptacles</b>	<i>2 outlets. Black. Mounting bracket included.</i>				
	5 1/2 x 1 x 5 3/4	142 x 25 x 146	LGC-4DUPLEXC_	182	-
<b>Specify circuit number at the end of the code (1, 2).</b>					

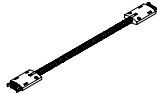
<b>Universal pass cables</b>	<i>Connects 2 duplex receptacles.</i>				
	18	457	LGC-PASS18	182	-
	36	914	LGC-PASS36	209	-
	54	1372	LGC-PASS54	235	-
	72	1829	LGC-PASS72	262	-

<b>Electrical feeds</b>	<i>72" (1829 mm) cable or 60" (1524 mm) long cable. Must be installed by an electrician.</i>				
	60	1524	LGC-FFEED60	340	-
	72	1829	LGC-FFEED72	342	-

2-TONE APPLICATION

TYPICAL TWO-TONE APPLICATION

SPECIFIC TWO-TONE APPLICATION

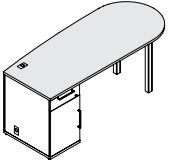
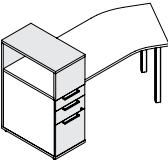
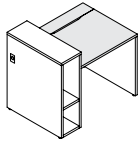
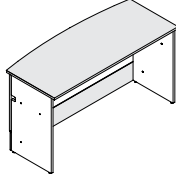
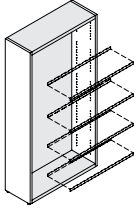
ALL PRODUCTS	LECTERN-DESKS	CPU TABLES	CIRCULATION DESKS	SHELVINGS
				
<p>The first finish specified will be applied to the top/surface of the unit.</p> <p>The second finish specified will be applied to the rest of the unit.</p>	<p>The first finish specified will be applied to the lectern top, front, base and drawers or doors of the unit.</p> <p>The second finish specified will be applied to the rest of the unit.</p>	<p>The first finish specified will be applied to the work surface of the unit.</p> <p>The second finish specified will be applied to the rest of the unit.</p>	<p>The first finish specified will be applied to the work surface and to the bottom portion of the modesty.</p> <p>The second finish specified will be applied to the rest of the unit.</p>	<p>The first finish specified will be applied to the top, base and back of the unit.</p> <p>The second finish specified will be applied to the rest of the unit.</p>

TYPICAL WOOD GRAIN DIRECTION FOR THINK SMART EDUCATIONAL FURNITURE

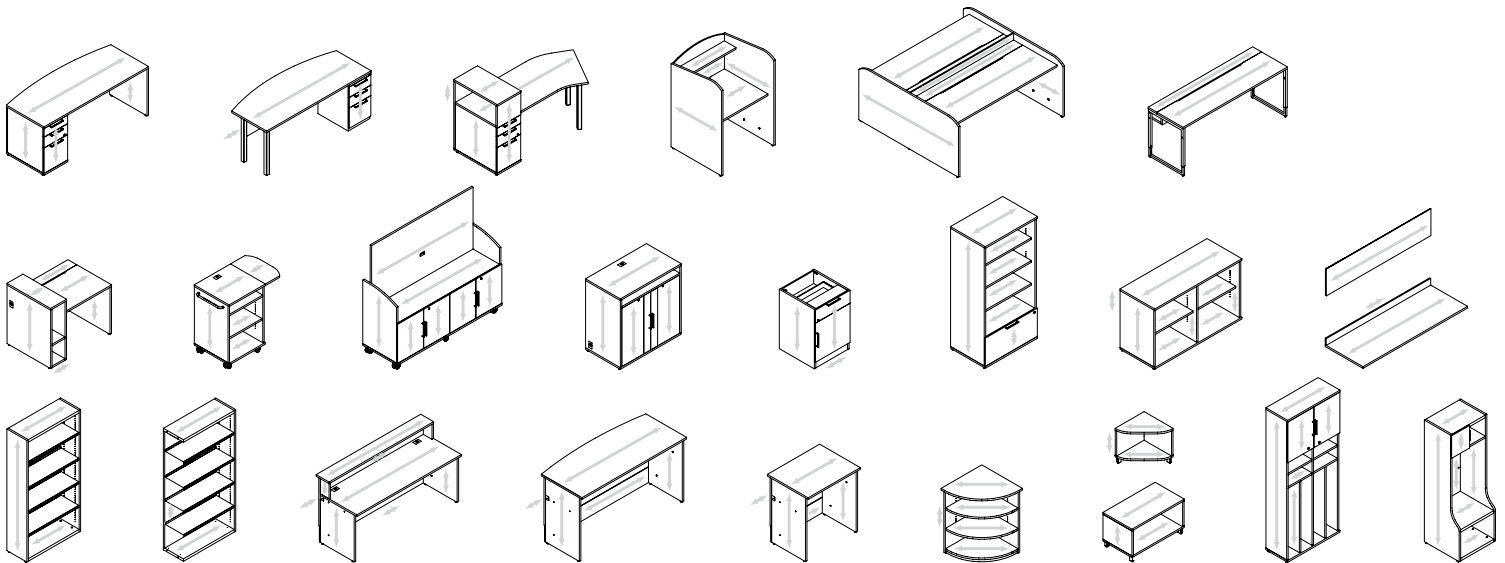

# TECHNICAL PERFORMANCES

## THERMOFUSED LAMINATE (TFL):

- Depending on the furniture collection, Lacasse casegoods have TFL surfaces and side panels made of particleboard panels of 1" (25.4 mm) or 1½" (38 mm) thick finished with a mar-resistant high-performance thermofused laminate (45 lbs/ft³). The particleboard panels are laminated on both sides for proper balance.
- TFL technology consists on a decorative paper impregnated with reactive melamine resins which is thermally fused to a substrate (particleboard). The heat and pressure produces a permanent thermal bond between the melamine resins, the decorative paper and the substrate. The bonding process results in a clear, hard and non-porous surface.
- TFL panels, unlike wood, will not gouge or dent.
- Delamination is not possible, due to the manufacturing process.
- TFL panels carry a 25-year warranty.

## HIGH-PRESSURE LAMINATE (HPL):

- Certain collections are also available with HPL surfaces made of 1¼" (27 mm) or 1⅞" (40 mm) thick particleboard finished with high-pressure laminate (laminate plus a ½" [0.8 mm] black backing).
- HPL technology consists of multiple layers of Kraft paper saturated with phenolic resin, a decorative layer of paper saturated with melamine resin, and a very thin top sheet of heavily saturated melamine resin. The high-pressure laminate sheet is then glued to a substrate (particleboard).
- HPL panels offer a good wear and impact resistance.
- HPL panels carry a 5-year warranty.