



ConnectTABLES® provides solutions for a variety of day-to-day work environments. Designed as easy-to-use linking or freestanding tables, ConnectTABLES is limited only by your imagination.

Open Conference

Many ConnectTABLES® tops can be assembled to be freestanding. When combined with locking casters and the flip top “T” leg, the result is easy storage and complete portability.

Meeting Rooms

ConnectTABLES® modular units will provide quick and affordable answers for all sizes and shapes of rooms and applications.

Educational and Training Rooms

ConnectTABLES® table tops configure easily into temporary or permanent educational applications.



Features and Benefits

- Optional, easy-to-use thumbscrews allow installation without tools.
- Optional zinc-plated steel ganging hardware connects free standing tops without moving “T” Leg position.
- Optional modesty panel wire management unit available.
- Casters will not affect table height when used in conjunction with or in place of glides.
- Optional Black grommets for convenient wire management can be ordered “factory installed”.
- Tops are 1” thick and constructed of 45 lb. density particleboard.
- Optional casters available with or without manual locks provide mobility.
- ConnectTABLES® tops are available in all Global laminate finishes with three leg and two edge color options.



T Leg with leveling glides



Modesty Panel

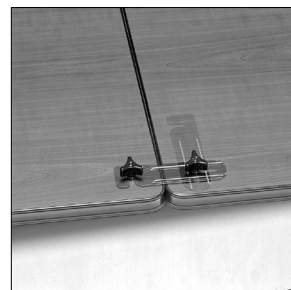

Optional ganging connector

GENERAL INFORMATION

- ConnecTABLES® is an affordable and highly flexible system of modular tables. Designed as easy-to-use linking or freestanding tables, ConnecTABLES adapts to most every requirement: seminar or training room, meeting room, personal workstations, educational, conferencing and team cluster workgroups.
- ConnecTABLES have nine basic top shapes available in various sizes.
- ConnecTABLES edges **do not match** any other Global product in either color or style.
- Global laminate and seating products are in compliance with stringent emission guidelines set out by the Greenguard Environmental Institute under the standards for low emitting products and materials. www.greenguard.org
- **Level 2 Certified**

WORKSURFACES

- Tops are 1" thick, made of 45 lb. density particle board covered on both sides with high performance thermally fused laminate.
- Laminate finishes are available in High Pressure. Contact your Customer Service Representative for a quote.
- If other than a Global standard laminate finish is preferred, contact your Customer Service Representative. Information needed includes the name of the laminate manufacturer, color name, number and model of table. You will then be given a quote for this special order.
- **ConnecTABLES® edges do not match any other Global product in either color or style.**
- Products specified with the high pressure laminate option are finished on the underside of the surface with a kraft paper backing.

CONSTRUCTION

- Some components can stand alone when the "T" base is set in the freestanding position. When the "T" base is in the linking position, all the components can be used in grouping configurations (clusters).
- Optional wire grommets not available on 45° wedge and the 60° triangle.
- Rectangular tops 54" in length and longer are supplied with a 16" gauge steel support channel. Top is pre-drilled for placement.
- Shipped RTA (ready to assemble). Quick and easy to assemble.
- Special width tops are available. Use next size up.
- Tables adjust from 28 3/4" to 29 3/4" high.
- Elliptical column cover, glides, casters, thumbscrews and endcaps available in Black only.
- Must specify top, edge, and "T" base color with each order.

LEGS

- "T" leg is coated with environmentally friendly, recyclable paint electrostatically applied epoxy powder coating for a very durable finish in three colors as specified below. Only the bottom horizontal portion of the painted leg is visible.
- Black plastic leveling glides offer 1" adjustability.
- Two black plastic elliptical column caps cover each leg column.
- Casters will not affect table height when used in conjunction with or in place of glides.
- Casters can facilitate mobility in installations which need to be moved frequently.

LAMINATE FINISHES

ACJ	Absolute Acajou	HGT	Hayden Grey
ASN	Asian Night	QTM	Quartered Mahogany
AWC	Avant Cherry	SKC	Shaker Cherry
AWH	Avant Honey	SOG	Storm Grey
BLK	Black	TFW	Tiger Fruitwood
BRC	Brushed Cobalt	TMP	Tiger Maple
CMB	Clear Maple	TWL	Tiger Walnut
DES	Dark Espresso	WHE	Walnut Heights
DWT	Designer White	WHC	White Chocolate*
GRY	Grey	WCR	Winter Cherry
		WGY	Willow Grey

*TFL is textured. HP tops are non-textured.

EDGE COLORS

Black (BK) Grey (GR)

LEG COLORS

Black (BK) Grey (GR) Chrome (CH)

GROMMETS

- Optional Grommets available in standard worksurface locations (left, center or right) for Rectangular Tables. Order as: **AG1, AG2 or AG3. Add \$65**
- Grommet hole dimensions are 3 1/4" wide x 1 7/8" deep.

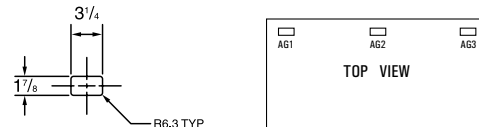

- Grommets may be placed at non-standard locations. Order as: **AGS - ADD \$65.00** A drawing must be supplied with vertical and horizontal dimensions to the center of the cut-out (as in drawing above). Please refer to CUSTOM GROMMET LOCATION FORM in the back reference section.

POWER BLOCK

- A Power Block (model **PMSPDM**) may be ordered on all worksurfaces.
- A Power Block is a rectangular worksurface power/data module with one electrical duplex receptacle and two data (RJ45) receptacles. 9' black cord included. Power Block dimensions are 3 1/2" deep x 6 1/2" wide x 2 3/4" high.
- To purchase a Power Block, you must specify both the Power Block cut-out location and the Power Block model #. Order Power Block as **PMSPDM, ADD \$253**. Power Blocks are available in standard worksurface locations (left, center or right). Order as **E1, E2 or E3. ADD \$65.00**.



Power Block **PMSPDM, Add \$253** Specify location **E1, E2 or E3, Add \$65**

EXAMPLES OF GROMMET AND POWER BLOCK POSITIONS

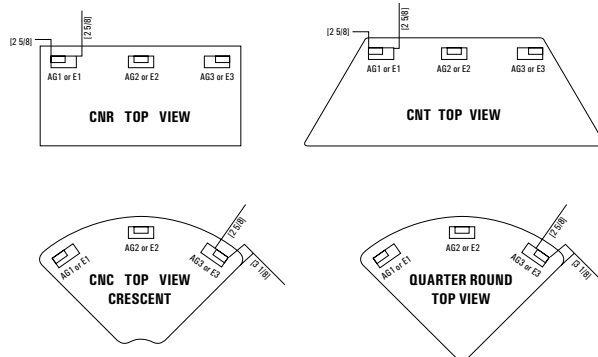

C CONNECTABLES® - NOTES

VILLA CUTOUTS

- Optional Villa cutout available in standard worksurface locations (left, center or right) for **Rectangular Tables**. Order as: **V1, V2 or V3.....Add \$65 for each cutout.**
- Villa cutouts may be placed at non-standard locations. Please contact customer service.
- **Villa is only available on Bungee, Junction and Connectables series**

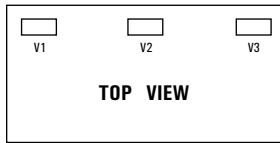

TOP & EDGE OPTIONS

- ConnectTABLES® have nine basic top shapes available in various sizes. All top shapes have a variety of straight or curved edges which are referred to as **Working (W), Connecting (C) or End (E) edges**. Edges can also have a combination of edge types as shown.
- *cannot freestand

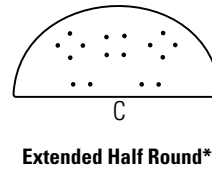
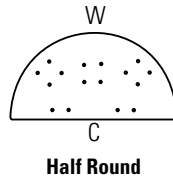
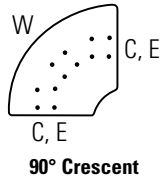
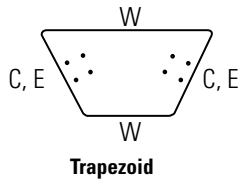
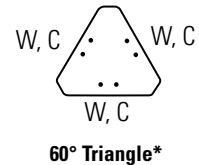
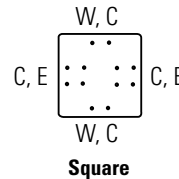
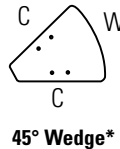
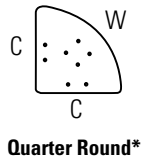
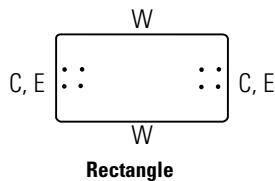

Working Edge (1) - Edges designated with the letter "W" indicate that this is a **working** or sitting edge. These edges can be connected with optional ganging hardware in free-standing applications.

Connecting Edge (2) - Edges designated with the letter "C" indicate that this is a **connecting** edge. These edges can be connected to any other connecting edge of equal width, regardless of the top shape or size.

End Edge (3) - Edges designated with the letter "E" indicate that this is an **end** edge or an edge that can finish a run of tops. If a top has two end edges it can be freestanding. 90° crescent tops can be freestanding if the optional center leg is added.

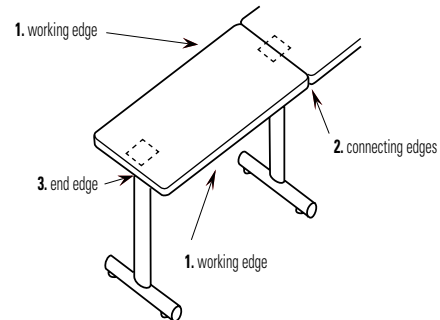

FREESTANDING AND CONNECTING CONDITIONS

Freestanding tables are defined as any one worksurface supported by two or more legs;

connecting tables are defined as more than one work surface supported by a single leg at each point of connection. The rule for determining the quantity of legs of an open configuration is the number of worksurfaces plus one (**See Figure 1**).

On closed configurations, the number of legs is equal to the number of worksurfaces (**See Figure 2**). There are some exceptions, such as when optional third legs are used on quarter round or 90° crescent shapes.

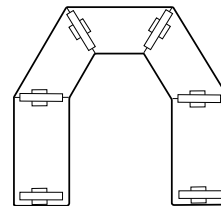

Figure 1. Open Configuration
Number of Surfaces = 5
Number of Legs = 6

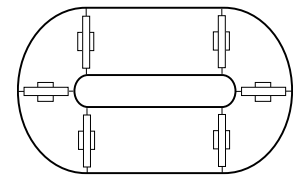

Figure 2. Closed Configuration
Number of Surfaces = 6
Number of Legs = 6

FREESTANDING CONDITIONS

- All square, rectangle and trapezoid shapes are able to act as freestanding tables (**Figure 3**).
- When Trapezoid tops are freestanding, legs must be on the outer left and right sides (**Figure 4**).
- 90° crescent work surfaces have provision for an optional third center leg for additional stability when heavy loads are applied to the outside edge. They can also be used as freestanding tables when a third leg is added (**Figure 5**).
- All freestanding tables can be connected with optional ganging hardware.
- Freestanding tables can be ganged with connected tables in some cases, providing that the number and size of connected tables is easily movable (**Figure 6**).
- **DO NOT DRAG TABLES WHEN RE-CONFIGURING.**

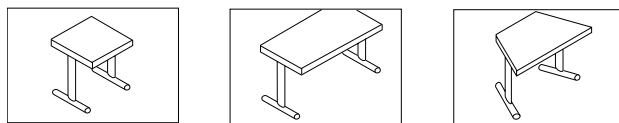
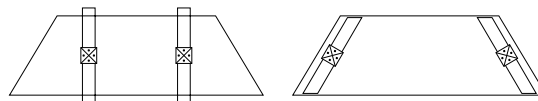

Figure 3 - Freestanding Tables



Incorrect

Correct

Figure 4 - Trapezoid Tops

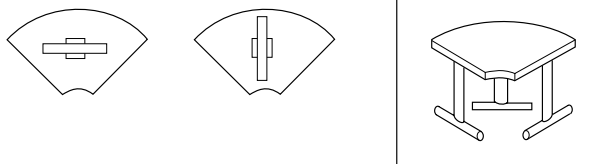

Figure 5 - Adding a Third Leg

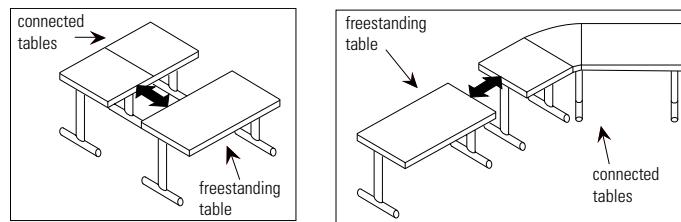

Figure 6 - Ganging with Connected Tables

CONNECTING CONDITIONS

- Any two worksurfaces of equal depth (24"D, 30"D or 36"D) can be connected with one leg, at the connecting or end edges (**Figure 8**).
- Half round work surfaces can be used in the following ways: They must be of equal width when connected to each other (**Figure 7**) or the connecting shapes must be equal to half the width of the connecting half round (**Figure 8**).
- ConnectABLES® is designed with the leg to be fastened parallel to connecting edges, but in some cases you may wish to fasten legs at 90° to connecting edges. This could allow for increased leg or knee clearance, depending on the intended use (**Figure 9**).
- Quarter round and 90° crescent work surfaces have provision for an optional third leg for additional stability when heavy loads are applied to the outside edge. For quarter round work surfaces, it is recommended that configuration "A" be used since the outside end of the center leg in configuration "B" is almost flush with the outside edge of the worksurface. If configuration "B" is installed against a wall or where there will be no traffic flow, then configuration "B" can be used.

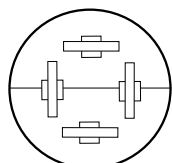

Figure 7

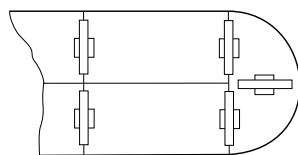

Figure 8

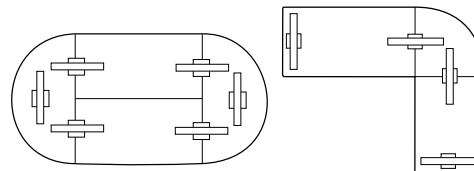
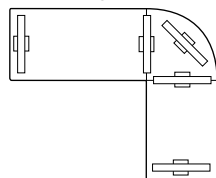
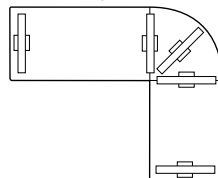

Figure 9 - 90° Leg Connections



Configuration A



Configuration B

C CONNECTABLES® - PUTTING IT ALL TOGETHER

Legs are fastened to work surfaces utilizing a steel-to-steel connection. Each leg comes equipped with four ¼" x 7/8" machine screws. Screws are inserted through the four oval shaped holes only. Do not use wood screws! When fastening legs to work surfaces, hand thread screws into position to prevent any cross threading. When all screws have been hand threaded, tighten firmly with screwdriver to secure. Optional thumbscrews can be used in place of machine screws. Thumbscrews eliminate the need for a screwdriver, whether assembling or disassembling tables. **Do not use power tools for assembly of legs.**

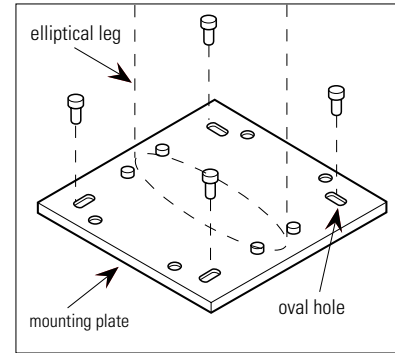

FREESTANDING TABLES

1. Turn work surface upside-down on clean floor. (You may want to use carton from packaging as a protective assembly surface to protect the top from scratching.)
2. Position leg mounting plate holes over threaded steel inserts in top.
3. Fasten each leg to top with four ¼" x 7/8" screws.
4. Turn table right-side up.
5. Level table by adjusting glides.

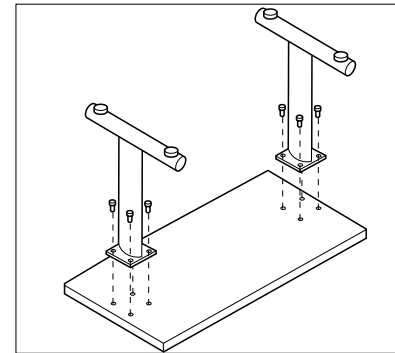

CONNECTING TABLES

1. Determine approximate location of desired configuration in room and turn work surfaces upside-down on floor. (Remember you are working in reverse.)
2. Position leg mounting plate so it is centered over the connecting edge of the first work surface. Fasten leg with two ¼" x 7/8" screws.
3. Repeat step 2 and 3 on the opposite edge of the first work surface.
4. Turn table right-side up.
5. Turn table right-side up and fasten to the previous top from the underside.
6. To add additional work surfaces repeat step 6.
7. When all the tops have been connected, level complete configuration by adjusting glides.

Note: Use the same procedures as above when using optional thumb screws.

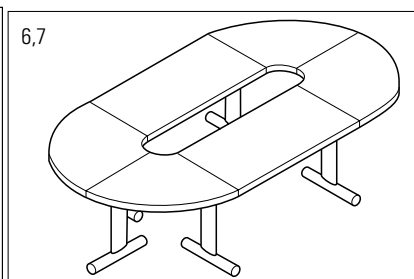
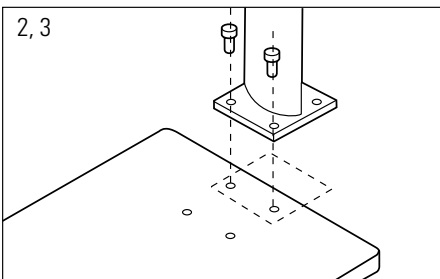
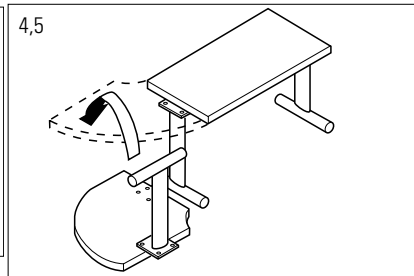
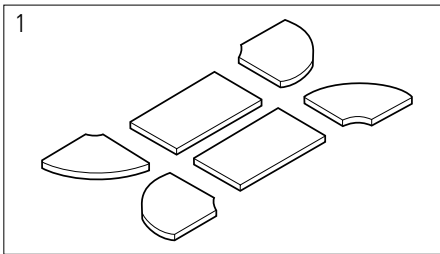

OPTIONAL CASTERS

1. Turn work surface upside-down on floor.
2. Remove existing glide if previously installed.
3. Fasten caster to T-leg by threading caster stem into base of T-leg and secure by tightening lock nut.
4. If casters are used in combination with gliders, level table by adjusting glides.

Note: Casters are available in locking or non-locking styles.

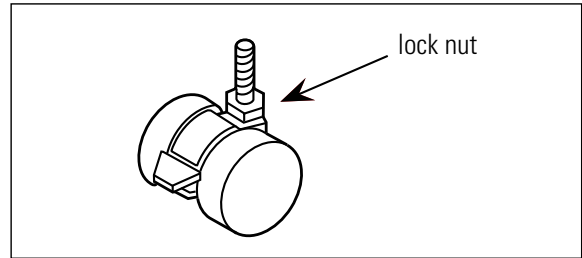
**OPTIONAL GANGING HARDWARE**

1. Optional ganging hardware should be used when quick and frequent reconfigurations are required.
2. Turn work surfaces to be ganged upside-down on floor.
3. Remove ganging hardware from package. Holes with steel inserts are located in the corner of tops.
4. Fasten ganging hardware to each work surface with supplied thumb screws.
5. Projected arm from ganging hardware can pivot out of the way when not in use.

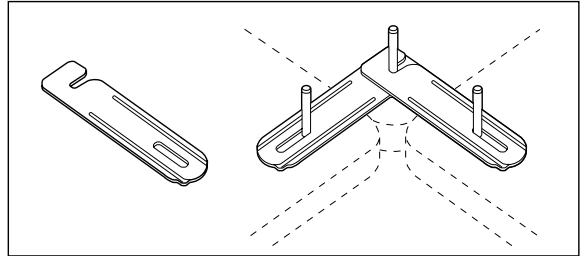

SQUARE TOPS

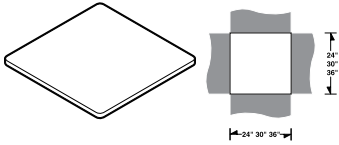

Square Top

MODEL#	DIMENSIONS	FREIGHT CLASS	WT./LBS.	CUBIC FT.	LIST PRICE
--------	------------	---------------	----------	-----------	------------

D x W x H

CNS2424	24 x 24 x 1.12	70	18	1	\$304
CNS3030	30 x 30 x 1.12	70	27	1.56	\$371
CNS3636	36 x 36 x 1.12	70	39	2	\$399

T-mold edging. Predrilled with threaded steel inserts for freestanding and linking installations.

RECTANGULAR TOPS

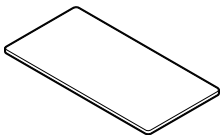
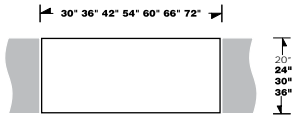

Rectangle Top

CNR2030	20 x 30 x 1.13	70	22	1.25	\$219
CNR2036	20 x 36 x 1.13	60	22.50	.46	\$244
CNR2042	20 x 42 x 1.13	70	31	1.75	\$263
CNR2048	20 x 48 x 1.13	70	35	2	\$293
CNRU2054	20 x 54 x 1.13	60	33.75	.69	\$364
CNRU2060	20 x 60 x 1.13	70	37.50	1.40	\$391
CNRU2066	20 x 66 x 1.13	70	41.25	.84	\$423
CNRU2072	20 x 72 x 1.13	70	45	1	\$451
CNR2430	24 x 30 x 1.12	70	22	1.25	\$219
CNR2436	24 x 36 x 1.12	70	26	1.50	\$244
CNR2442	24 x 42 x 1.12	70	31	1.75	\$263
CNR2448	24 x 48 x 1.12	70	35	2	\$293
CNRU2454	24 x 54 x 1.12	70	42	2.34	\$364
CNRU2460	24 x 60 x 1.12	70	47	2.50	\$391
CNRU2466	24 x 66 x 1.12	70	52	2.80	\$423
CNRU2472	24 x 72 x 1.12	70	57	3	\$451
CNR3036	30 x 36 x 1.12	70	33	1.88	\$293
CNR3042	30 x 42 x 1.12	70	38	2.19	\$318
CNR3048	30 x 48 x 1.13	70	44	2.50	\$337
CNRU3054	30 x 54 x 1.12	70	52	2.80	\$418
CNRU3060	30 x 60 x 1.12	70	59	3.13	\$449
CNRU3066	30 x 66 x 1.12	70	64	3.44	\$479
CNRU3072	30 x 72 x 1.12	70	70	3.75	\$511
CNR3642	36 x 42 x 1.12	60	52.50	1.60	\$423
CNR3648	36 x 48 x 1.12	60	60	1.80	\$462
CNRU3654	36 x 54 x 1.12	60	70	2	\$559
CNRU3660	36 x 60 x 1.12	60	78	2.20	\$621
CNRU3666	36 x 66 x 1.12	60	87	2.40	\$679
CNRU3672	36 x 72 x 1.12	60	94	2.60	\$740

T-mold edging. Predrilled with threaded steel inserts for freestanding and linking installations. **Tops 54" and longer are standard with a 16 gauge steel support channel.**

TRAPEZOID TOPS

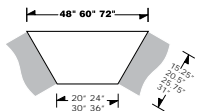

Trapezoid Top

CNT2048	15.25 x 48 x 1.13	65	26.25	.55	\$307
CNT2060	15.25 x 60 x 1.13	65	44	1.85	\$369
CNT2448	20.5 x 48 x 1.12	92.5	21	2	\$307
CNT2460	20.5 x 60 x 1.12	65	44	1.85	\$369
CNT3060	25.75 x 60 x 1.12	92.5	35	3.13	\$404
CNT3072	25.75 x 72 x 1.12	60	66	2.20	\$451
CNT3660	31 x 60 x 1.12	60	66	2.20	\$577
CNT3672	31 x 72 x 1.12	65	79.20	3.50	\$689

T-mold edging. Predrilled with threaded steel inserts for freestanding and linking installations.

Required Specifications

Top Finish
Edge Finish

Optional Specifications

Grommet

Accessories

Power Block

90° CRESCENT TOPS

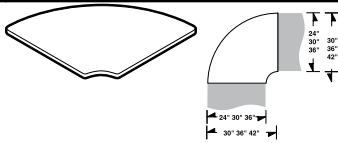

90° Crescent Top

MODEL# DIMENSIONS FREIGHT CLASS WT./LBS. CUBIC FT. LIST PRICE

MODEL#	D x W x H	FREIGHT CLASS	WT./LBS.	CUBIC FT.	LIST PRICE
CNC2430	30 x 30 x 1.12	85	20	1.56	\$322
CNC3036	36 x 36 x 1.12	85	30	2.25	\$458
CNC3642	42 x 42 x 1.12	70	50	3.15	\$628

T-mold edging. Predrilled with threaded steel inserts for freestanding and linking installations.

- **CNC2430** for use with 24" deep tops
- **CNC3036** for use with 30" deep tops
- **CNC3642** for use with 36" deep tops
- **CNC2430** does not require a center leg

QUARTER ROUND TOPS

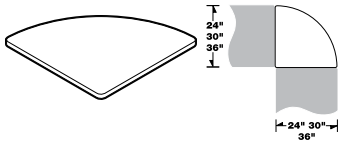

Quarter Round Top

CNQ2424	24 x 24 x 1.12	85	14	1	\$202
CNQ3030	30 x 30 x 1.12	85	21	1.56	\$245
CNQ3636	36 x 36 x 1.12	60	45	1.30	\$348

T-mold edging. Predrilled with threaded steel inserts for **linking installations ONLY**.

45° WEDGE TOPS

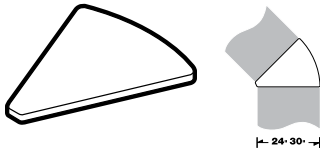

45° Wedge Top

CNW2424	24 x 24 x 1.12	92.5	10	1	\$216
CNW3030	30 x 30 x 1.12	100	14	1.56	\$264

T-mold edging. Predrilled with threaded steel inserts for **linking installations ONLY**.

THREE WAY CONNECTOR TOPS

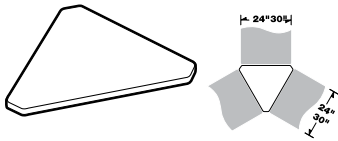

Three Way Connector Top

CNY2424	24 x 24 x 1.12	85	13	1	\$202
CNY3030	30 x 30 x 1.12	92.5	18	1.56	\$245

T-mold edging. Predrilled with threaded steel inserts for **linking installations ONLY**.

HALF ROUND TOPS

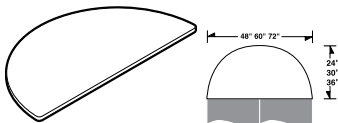

Half Round Top

CNHFS2448	24 x 48 x 1.12	70	36	2	\$310
CNHFS3060	30 x 60 x 1.12	70	56	3.13	\$402
CNHFS3672	36 x 72 x 1.12	65	81	3.30	\$689

T-mold edging. Predrilled with threaded steel inserts for freestanding and linking installations.

- *Requires three legs for freestanding*

EXTENDED HALF ROUND TOPS

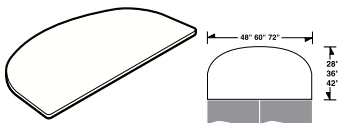

Extended Half Round Top

CNHE24	28 x 48 x 1.13	65	50	1.88	\$379
CNHE30	36 x 60 x 1.13	65	75	2.87	\$529
CNHE36	42 x 72 x 1.13	65	102	3.88	\$841

T-mold edging. Predrilled with threaded steel inserts for **linking installations ONLY**.

Required Specifications

Top Finish
Edge Finish

Optional Specifications

Grommet

Accessories

Power Block

MODESTY PANELS



Modesty Panel

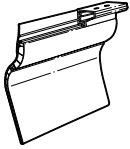

Modesty Panel

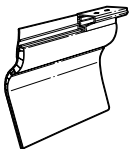

Modesty Panel

MODEL#	DIMENSIONS D x W x H	FREIGHT CLASS	WT./LBS.	CUBIC FT.	LIST PRICE
CNCA2430	2.75 x 35 x 11.75	150	2.80	.50	\$179
CNCA3036	2.75 x 43 x 11.75	150	3.30	.60	\$210
CNCA3642	2.75 x 53 x 11.75	150	3.90	.70	\$275

For use with **CNC crescent tops**. 11 3/4" high, Black plastic, attractive ribbed design. Includes two fold-away installation clips and flexible privacy strips. Connects to predrilled holes in table top.

- *Can not be used when worksurface tops are attached to flip top legs.*

CNOA2424	2.75 x 27 x 11.75	150	2.20	.40	\$153
CNOA3030	2.75 x 35 x 11.75	150	2.80	.50	\$179
CNOA3636	2.75 x 44 x 11.75	150	3.30	.60	\$210

For use with **CNQ quarter round tops**. 11 3/4" high, Black plastic, attractive ribbed design. Includes two fold-away installation clips and flexible privacy strips. Connects to predrilled holes in table top.

- *Can not be used when worksurface tops are attached to flip top legs.*

CNRA2030	2.75 x 29 x 11.75	150	2.80	.50	\$153
CNRA2036	2.75 x 35 x 11.75	150	3.30	.60	\$179
CNRA2042	2.75 x 41 x 11.75	150	3.90	.70	\$210
CNRA2048	2.75 x 47 x 11.75	150	4.40	.80	\$238
CNRA2054	2.75 x 53 x 11.75	150	5	.90	\$275
CNRA2060	2.75 x 59 x 11.75	150	5.50	1	\$298
CNRA2066	2.75 x 65 x 11.75	150	6.10	1.10	\$327
CNRA2072	2.75 x 71 x 11.75	150	6.60	1.20	\$357

CNRA2430	2.75 x 29 x 11.75	150	2.80	.50	\$153
CNRA2436	2.75 x 35 x 11.75	150	3.30	.60	\$179
CNRA2442	2.75 x 41 x 11.75	150	3.90	.70	\$210
CNRA2448	2.75 x 47 x 11.75	150	4.40	.80	\$238
CNRA2454	2.75 x 53 x 11.75	150	5	.90	\$275
CNRA2460	2.75 x 59 x 11.75	150	5.50	1	\$298
CNRA2466	2.75 x 65 x 11.75	150	6.10	1.10	\$327
CNRA2472	2.75 x 71 x 11.75	150	6.60	1.20	\$357

CNRA3036	2.75 x 35 x 11.75	150	3.30	.60	\$179
CNRA3042	2.75 x 41 x 11.75	150	3.90	.70	\$210
CNRA3048	2.75 x 47 x 11.75	150	4.40	.80	\$238
CNRA3054	2.75 x 53 x 11.75	150	5	.90	\$275
CNRA3060	2.75 x 59 x 11.75	150	5.50	1	\$298
CNRA3066	2.75 x 65 x 11.75	150	6.10	1.10	\$327
CNRA3072	2.75 x 71 x 11.75	150	6.60	1.20	\$357

CNRA3642	2.75 x 41 x 11.75	150	3.90	.70	\$210
CNRA3648	2.75 x 47 x 11.75	150	4.40	.80	\$238
CNRA3654	2.75 x 53 x 11.75	150	5	.90	\$275
CNRA3660	2.75 x 59 x 11.75	150	5.50	1	\$298
CNRA3666	2.75 x 65 x 11.75	150	6.10	1.10	\$327
CNRA3672	2.75 x 71 x 11.75	150	6.60	1.20	\$357

For use with **CNR/CNRU rectangular tops**. 11 3/4" high, Black plastic, attractive ribbed design. Includes two fold-away installation clips and flexible privacy strips. Connects to predrilled holes in table top.

- *Can not be used when worksurface tops are attached to flip top legs.*

Required Specifications

Top Finish
Edge Finish

Optional Specifications

Grommet

Accessories

Power Block

MODESTY PANELS

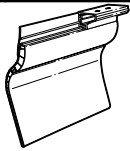

Modesty Panel

MODEL# DIMENSIONS FREIGHT CLASS WT/LBS. CUBIC FT. LIST PRICE

D x W x H

CNSA2424	2.75 x 23 x 11.75	150	2.20	.40	\$122
CNSA3030	2.75 x 29 x 11.75	150	2.80	.50	\$153
CNSA3636	2.75 x 35 x 11.75	150	3.30	.60	\$179

For use with **long side of CNS square tops**. 11 3/4" high, Black plastic, attractive ribbed design. Includes two fold-away installation clips and flexible privacy strips. Connects to predrilled holes in table top.

- *Can not be used when worksurface tops are attached to flip top legs.*

CNTA2048L	2.75 x 43 x 11.75	150	4.40	.80	\$210
CNTA2060L	2.75 x 55 x 11.75	150	5.50	1.20	\$275

CNTA2448L	2.75 x 43 x 11.75	150	4.40	.80	\$210
CNTA2460L	2.75 x 55 x 11.75	150	5.50	1.20	\$275

CNTA3060L	2.75 x 55 x 11.75	150	5.50	1.20	\$275
CNTA3072L	2.75 x 67 x 11.75	150	6.60	1.40	\$327

CNTA3660L	2.75 x 55 x 11.75	150	5.50	1.20	\$275
CNTA3672L	2.75 x 67 x 11.75	150	6.60	1.40	\$327

For use with **long side of CNT trapezoid tops**. 11 3/4" high, Black plastic, attractive ribbed design. Includes two fold-away installation clips and flexible privacy strips. Connects to predrilled holes in table top.

- *Can not be used when worksurface tops are attached to flip top legs.*

CNTA2048S	2.75 x 24 x 11.75	150	2.20	.40	\$122
CNTA2060S	2.75 x 36 x 11.75	150	2.80	.50	\$179

CNTA2448S	2.75 x 23 x 11.75	150	2.20	.40	\$122
CNTA2460S	2.75 x 35 x 11.75	150	2.20	.40	\$179

CNTA3060S	2.75 x 29 x 11.75	150	2.80	.50	\$153
CNTA3072S	2.75 x 41 x 11.75	150	2.80	.50	\$210

CNTA3660S	2.75 x 23 x 11.75	150	3.30	.60	\$122
CNTA3672S	2.75 x 35 x 11.75	150	3.30	.60	\$179

For use with **short side of CNT trapezoid tops**. 11 3/4" high, Black plastic, attractive ribbed design. Includes two fold-away installation clips and flexible privacy strips. Connects to predrilled holes in table top.

- *Can not be used when worksurface tops are attached to flip top legs.*

CNWA2424	2.75 x 17 x 11.75	150	2.20	.40	\$94
CNWA3030	2.75 x 22 x 11.75	150	2.80	.50	\$122

For use with **CNW wedge tops**. 11 3/4" high, Black plastic, attractive ribbed design. Includes two fold-away installation clips and flexible privacy strips. Connects to predrilled holes in table top.

- *Can not be used when worksurface tops are attached to flip top legs.*

CNYA2424	2.75 x 22 x 11.75	150	2.20	.40	\$114
CNYA3030	2.75 x 27 x 11.75	150	2.80	.50	\$140

For use with **CNY triangle tops**. 11 3/4" high, Black plastic, attractive ribbed design. Includes two fold-away installation clips and flexible privacy strips. Connects to predrilled holes in table top.

- *Can not be used when worksurface tops are attached to flip top legs.*

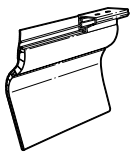

Modesty Panel

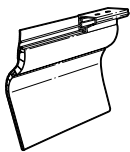

Modesty Panel

Required Specifications

Top Finish
Edge Finish

Optional Specifications

Grommet

Accessories

Power Block

WIRE MANAGEMENT UNITS

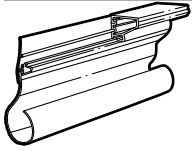

Wire Management Unit

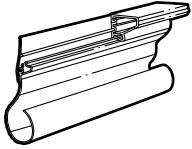

Wire Management Unit

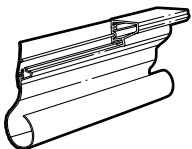

Wire Management Unit

MODEL#	DIMENSIONS D x W x H	FREIGHT CLASS	WT./LBS.	CUBIC FT.	LIST PRICE
CNCB2430	2.75 x 35 x 6	70	1.50	.50	\$134
CNCB3036	2.75 x 43 x 6	70	1.80	.60	\$151
CNCB3642	2.75 x 53 x 6	250	2.10	.70	\$197

For use with **CNC crescent tops**. 6" high, Black plastic, attractive ribbed design. Includes two fold-away installation clips and flexible privacy strips. Connects to predrilled holes in table top. Can be used with or without wire management grommet.

- *Can not be used when worksurface tops are attached to flip top legs.*

CNQB2424	2.75 x 27 x 6	70	1.20	.40	\$113
CNQB3030	2.75 x 35 x 6	70	1.50	.50	\$134
CNQB3636	2.75 x 44 x 6	70	1.80	.60	\$175

For use with **CNQ quarter round tops**. 6" high, Black plastic, attractive ribbed design. Includes two fold-away installation clips and flexible privacy strips. Connects to predrilled holes in table top. Can be used with or without wire management grommet.

- *Can not be used when worksurface tops are attached to flip top legs.*

CNRB2030	2.75 x 29 x 6	70	1.50	.50	\$113
CNRB2036	2.75 x 35 x 6	70	1.80	.60	\$134
CNRB2042	2.75 x 41 x 6	250	2.10	.70	\$151
CNRB2048	2.75 x 47 x 6	250	2.40	.80	\$210
CNRB2054	2.75 x 53 x 6	250	2.70	.90	\$219
CNRB2060	2.75 x 59 x 6	250	3	1	\$219
CNRB2066	2.75 x 65 x 6	250	3.30	1.10	\$219
CNRB2072	2.75 x 71 x 6	250	3.60	1.20	\$298

CNRB2430	2.75 x 29 x 6	70	1.50	.50	\$113
CNRB2436	2.75 x 35 x 6	70	1.80	.60	\$134
CNRB2442	2.75 x 41 x 6	250	2.10	.70	\$151
CNRB2448	2.75 x 47 x 6	250	2.40	.80	\$210
CNRB2454	2.75 x 53 x 6	250	2.70	.90	\$219
CNRB2460	2.75 x 59 x 6	250	3	1	\$219
CNRB2466	2.75 x 65 x 6	250	3.30	1.10	\$219
CNRB2472	2.75 x 71 x 6	250	3.60	1.20	\$298

CNRB3036	2.75 x 35 x 6	70	1.80	.60	\$134
CNRB3042	2.75 x 41 x 6	250	2.10	.70	\$151
CNRB3048	2.75 x 47 x 6	250	2.40	.80	\$175
CNRB3054	2.75 x 53 x 6	250	2.70	.90	\$197
CNRB3060	2.75 x 59 x 6	250	3	1	\$219
CNRB3066	2.75 x 65 x 6	250	3.30	1.10	\$260
CNRB3072	2.75 x 71 x 6	250	3.60	1.20	\$298

CNRB3642	2.75 x 41 x 6	250	2.10	.70	\$151
CNRB3648	2.75 x 47 x 6	250	2.40	.80	\$197
CNRB3654	2.75 x 53 x 6	250	2.70	.90	\$197
CNRB3660	2.75 x 59 x 6	250	3	1	\$219
CNRB3666	2.75 x 65 x 6	250	3.30	1.10	\$219
CNRB3672	2.75 x 71 x 6	250	3.60	1.20	\$298

For use with **CNR/CNRU rectangular tops**. 6" high, Black plastic, attractive ribbed design. Includes two fold-away installation clips and flexible privacy strips. Connects to predrilled holes in table top. Can be used with or without wire management grommet.

- *Can not be used when worksurface tops are attached to flip top legs.*

Required Specifications

Top Finish
Edge Finish

Optional Specifications

Grommet

Accessories

Power Block

WIRE MANAGEMENT UNITS

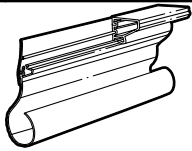

Wire Management Unit

MODEL# DIMENSIONS FREIGHT CLASS WT/LBS. CUBIC FT. LIST PRICE

D x W x H

CNSB2424	2.75 x 23 x 6	70	1.80	.40	\$90
CNSB3030	2.75 x 29 x 6	70	1.50	.50	\$113
CNSB3636	2.75 x 35 x 6	70	1.80	.60	\$134

For use with **CNS square tops**. 6" high, Black plastic, attractive ribbed design. Includes two fold-away installation clips and flexible privacy strips. Connects to predrilled holes in table top. Can be used with or without wire management grommet.

- *Can not be used when worksurface tops are attached to flip top legs.*

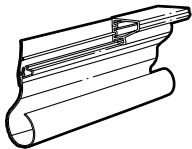

Wire Management Unit

CNTB2048L	2.75 x 43 x 6	250	2.40	.80	\$151
CNTB2060L	2.75 x 55 x 6	250	3	1	\$197
CNTB2448L	2.75 x 43 x 6	250	2.40	.80	\$151
CNTB2460L	2.75 x 55 x 6	250	3	1	\$197
CNTB3060L	2.75 x 55 x 6	250	3	1	\$197
CNTB3072L	2.75 x 67 x 6	250	3.60	1.20	\$275
CNTB3660L	2.75 x 55 x 6	250	3	1	\$197
CNTB3672L	2.75 x 67 x 6	250	3.60	1.20	\$275

For use with **long side of CNT trapezoid tops**. 6" high, Black plastic, attractive ribbed design. Includes two fold-away installation clips and flexible privacy strips. Connects to predrilled holes in table top. Can be used with or without wire management grommet.

- *Can not be used when worksurface tops are attached to flip top legs.*

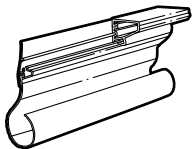

Wire Management Unit

CNTB2048S	2.75 x 23 x 6	70	1.20	.40	\$90
CNTB2060S	2.75 x 35 x 6	70	1.50	.50	\$134
CNTB2448S	2.75 x 23 x 6	70	1.20	.40	\$90
CNTB2460S	2.75 x 35 x 6	70	1.20	.40	\$134
CNTB3060S	2.75 x 29 x 6	70	1.50	.50	\$113
CNTB3072S	2.75 x 41 x 6	70	1.50	.50	\$151
CNTB3660S	2.75 x 23 x 6	70	1.80	.60	\$90
CNTB3672S	2.75 x 35 x 6	70	1.80	.60	\$134

For use with **short side of CNT trapezoid tops**. 6" high, Black plastic, attractive ribbed design. Includes two fold-away installation clips and flexible privacy strips. Connects to predrilled holes in table top. Can be used with or without wire management grommet.

- *Can not be used when worksurface tops are attached to flip top legs.*

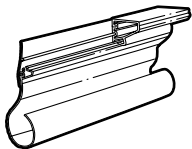

Wire Management Unit

CNWB2424	2.75 x 17 x 6	70	1.20	.40	\$73
CNWB3030	2.75 x 22 x 6	70	1.50	.50	\$90

For use with **CNW wedge tops**. 6" high, Black plastic, attractive ribbed design. Includes two fold-away installation clips and flexible privacy strips. Connects to predrilled holes in table top. Can be used with or without wire management grommet.

- *Can not be used when worksurface tops are attached to flip top legs.*

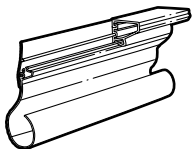

Wire Management Unit

CNYB2424	2.75 x 22 x 6	70	1.20	.40	\$90
CNYB3030	2.75 x 27 x 6	70	1.50	.50	\$113

For use with **CNY triangle tops**. 6" high, Black plastic, attractive ribbed design. Includes two fold-away installation clips and flexible privacy strips. Connects to predrilled holes in table top. Can be used with or without wire management grommet.

- *Can not be used when worksurface tops are attached to flip top legs.*

Required Specifications

Top Finish
Edge Finish

Optional Specifications

Grommet

Accessories

Power Block

MODESTY PANEL WITH WIRE MANAGEMENT

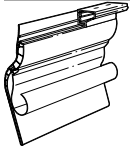

Modesty Panel with Wire Management

MODEL#	DIMENSIONS D x W x H	FREIGHT CLASS	WT./LBS.	CUBIC FT.	LIST PRICE
CNCC2430	2.75 x 35 x 11.75	100	4.30	.50	\$197
CNCC3036	2.75 x 43 x 11.75	100	5.10	.60	\$224
CNCC3642	2.75 x 53 x 11.75	100	6	.70	\$290

For use with **CNC crescent tops**. 11 3/4" high, Black plastic, attractive ribbed design. Includes two fold-away installation clips and flexible privacy strips. Connects to predrilled holes in table top. Can be used with or without wire management grommet.

- *Can not be used when worksurface tops are attached to flip top legs.*

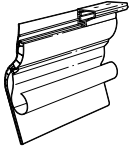

Modesty Panel with Wire Management

CNQC2424	2.75 x 27 x 11.75	100	3.40	.40	\$163
CNQC3030	2.75 x 35 x 11.75	100	4.30	.50	\$197
CNQC3636	2.75 x 44 x 11.75	100	5.10	.60	\$224

For use with **CNC quarter round tops**. 11 3/4" high, Black plastic, attractive ribbed design. Includes two fold-away installation clips and flexible privacy strips. Connects to predrilled holes in table top. Can be used with or without wire management grommet.

- *Can not be used when worksurface tops are attached to flip top legs.*

CNRC2030	2.75 x 29 x 11.75	100	4.30	.50	\$163
CNRC2036	2.75 x 35 x 11.75	100	5.10	.60	\$197
CNRC2042	2.75 x 41 x 11.75	100	6	.70	\$224
CNRC2048	2.75 x 47 x 11.75	100	6.80	.80	\$261
CNRC2054	2.75 x 53 x 11.75	100	7.70	.90	\$290
CNRC2060	2.75 x 59 x 11.75	100	8.50	1	\$323
CNRC2066	2.75 x 65 x 11.75	100	9.40	1.10	\$349
CNRC2072	2.75 x 71 x 11.75	100	10.20	1.20	\$369
CNRC2430	2.75 x 29 x 11.75	100	4.30	.50	\$163
CNRC2436	2.75 x 35 x 11.75	100	5.10	.60	\$197
CNRC2442	2.75 x 41 x 11.75	100	6	.70	\$224
CNRC2448	2.75 x 47 x 11.75	100	6.80	.80	\$261
CNRC2454	2.75 x 53 x 11.75	100	7.70	.90	\$290
CNRC2460	2.75 x 59 x 11.75	100	8.50	1	\$323
CNRC2466	2.75 x 65 x 11.75	100	9.40	1.10	\$349
CNRC2472	2.75 x 71 x 11.75	100	10.20	1.20	\$369
CNRC3036	2.75 x 35 x 11.75	100	5.10	.60	\$197
CNRC3042	2.75 x 41 x 11.75	100	6	.70	\$224
CNRC3048	2.75 x 47 x 11.75	100	6.80	.80	\$261
CNRC3054	2.75 x 53 x 11.75	100	7.70	.90	\$290
CNRC3060	2.75 x 59 x 11.75	100	8.50	1	\$323
CNRC3066	2.75 x 65 x 11.75	100	9.40	1.10	\$349
CNRC3072	2.75 x 71 x 11.75	100	10.20	1.20	\$369
CNRC3642	2.75 x 41 x 11.75	100	6	.70	\$224
CNRC3648	2.75 x 47 x 11.75	100	6.80	.80	\$261
CNRC3654	2.75 x 53 x 11.75	100	7.70	.90	\$290
CNRC3660	2.75 x 59 x 11.75	100	8.50	1	\$323
CNRC3666	2.75 x 65 x 11.75	100	9.40	1.10	\$349
CNRC3672	2.75 x 71 x 11.75	100	10.20	1.20	\$369

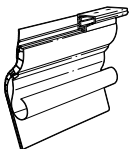

Modesty Panel with Wire Management

For use with **CNR/CNRU rectangular tops**. 11 3/4" high, Black plastic, attractive ribbed design. Includes two fold-away installation clips and flexible privacy strips. Connects to predrilled holes in table top. Can be used with or without wire management grommet.

- *Can not be used when worksurface tops are attached to flip top legs.*

Required Specifications

Top Finish
Leg Finish
Edge Finish

Optional Specifications

Grommet

Accessories

Power Block

MODESTY PANEL WITH WIRE MANAGEMENT

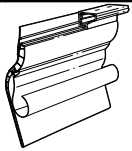

Modesty Panel with Wire Management

MODEL# DIMENSIONS FREIGHT CLASS WT./LBS. CUBIC FT. LIST PRICE

D x W x H

CNSC2424	2.75 x 23 x 11.75	100	3.50	.40	\$134
CNSC3030	2.75 x 29 x 11.75	100	4.30	.50	\$163
CNSC3636	2.75 x 35 x 11.75	100	5.10	.60	\$197

For use with **CNC square tops**. 11 3/4" high, Black plastic, attractive ribbed design. Includes two fold-away installation clips and flexible privacy strips. Connects to predrilled holes in table top. Can be used with or without wire management grommet.

- *Can not be used when worksurface tops are attached to flip top legs.*

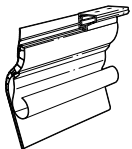

Modesty Panel with Wire Management

CNTC2048L	2.75 x 43 x 11.75	100	6.80	.80	\$224
CNTC2060L	2.75 x 55 x 11.75	100	8.50	1	\$290
CNTC2448L	2.75 x 43 x 11.75	100	6.80	.80	\$224
CNTC2460L	2.75 x 55 x 11.75	100	8.50	1	\$290
CNTC3060L	2.75 x 55 x 11.75	100	8.50	1	\$290
CNTC3072L	2.75 x 67 x 11.75	100	10.20	1.20	\$349
CNTC3660L	2.75 x 55 x 11.75	100	8.50	1	\$290
CNTC3672L	2.75 x 67 x 11.75	100	10.20	1.20	\$349

For use with **long side of CNT trapezoid tops**. 11 3/4" high, Black plastic, attractive ribbed design. Includes two fold-away installation clips and flexible privacy strips. Connects to predrilled holes in table top. Can be used with or without wire management grommet.

- *Can not be used when worksurface tops are attached to flip top legs.*

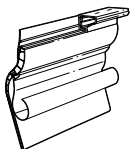

Modesty Panel with Wire Management

CNTC2048S	2.75 x 24 x 11.75	100	3.40	.40	\$134
CNTC2060S	2.75 x 36 x 11.75	100	3.50	.50	\$197
CNTC2448S	2.75 x 23 x 11.75	100	3.40	.40	\$134
CNTC2460S	2.75 x 35 x 11.75	100	3.40	.40	\$197
CNTC3060S	2.75 x 29 x 11.75	100	4.30	.50	\$163
CNTC3072S	2.75 x 41 x 11.75	100	4.30	.50	\$224
CNTC3660S	2.75 x 23 x 11.75	100	5.10	.60	\$134
CNTC3672S	2.75 x 35 x 11.75	100	5.10	.60	\$197

For use with **short side of CNT trapezoid tops**. 11 3/4" high, Black plastic, attractive ribbed design. Includes two fold-away installation clips and flexible privacy strips. Connects to predrilled holes in table top. Can be used with or without wire management grommet.

- *Can not be used when worksurface tops are attached to flip top legs.*

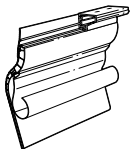

Modesty Panel with Wire Management

CNWC2424	2.75 x 17 x 11.75	100	3.40	.40	\$110
CNWC3030	2.75 x 22 x 11.75	100	4.30	.50	\$134

For use with **CNW wedge tops**. 11 3/4" high, Black plastic, attractive ribbed design. Includes two fold-away installation clips and flexible privacy strips. Connects to predrilled holes in table top. Can be used with or without wire management grommet.

- *Can not be used when worksurface tops are attached to flip top legs.*

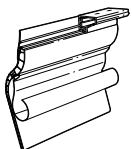

Modesty Panel with Wire Management

CNYC2424	2.75 x 22 x 11.75	100	3.40	.40	\$134
CNYC3030	2.75 x 27 x 11.75	100	4.30	.50	\$163

For use with **CNY triangle tops**. 11 3/4" high, Black plastic, attractive ribbed design. Includes two fold-away installation clips and flexible privacy strips. Connects to predrilled holes in table top. Can be used with or without wire management grommet.

- *Can not be used when worksurface tops are attached to flip top legs.*

Required Specifications

Top Finish
Leg Finish
Edge Finish

Optional Specifications

Grommet

Accessories

Power Block

T LEGS

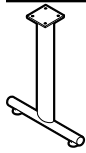

"T" Leg

MODEL#	DIMENSIONS D x W x H	FREIGHT CLASS	WT./LBS.	CUBIC FT.	LIST PRICE
GCNTLEG18	5.25 x 18 x 27.63	125	15	2.10	\$207
GCNTLG18P	5.25 x 18 x 27.63	125	17	2.10	\$409

18" long with plastic elliptical column cover, leveling glides and end caps. **For assembly with 20" tops.**

- For a single leg, order **GCNTLEG18**.
- For a pair of legs (set of 2), order **GCNTLG18P**.
- Chrome (CH) is available (on foot only). **ADD \$70.00** list for model GCNTLEG18 and **\$140.00** list for model GCNTLG18P.

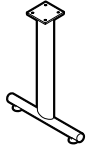

"T" Leg

GCNTLEG24	5.25 x 20 x 27.63	150	9	2.10	\$207
GCNTLG24P	5.25 x 20 x 27.63	100	17	2.10	\$409

20" long with plastic elliptical column cover, leveling glides and end caps. **For assembly with 24" tops.**

- For a single leg, order **GCNTLEG24**.
- For a pair of legs (set of 2), order **GCNTLG24P**.
- Chrome (CH) is available (on foot only). **ADD \$70.00** list for model GCNTLEG24 and **\$140.00** list for model GCNTLG24P.

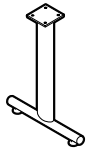

"T" Leg

GCNTLEG30	5.25 x 26 x 27.63	250	10	2.60	\$224
GCNTLG30P	5.25 x 26 x 27.63	125	19	2.60	\$446

26" long with plastic elliptical column cover, leveling glides and end caps. **For assembly with 30" tops.**

- For a single leg, order **GCNTLEG30**.
- For a pair of legs (set of 2), order **GCNTLG30P**.
- Chrome (CH) is available (on foot only). **ADD \$70.00** list for model GCNTLEG30 and **\$140.00** list for model GCNTLG30P.

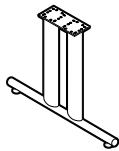

"T" Leg

GCNTLEG36	5.75 x 32 x 27.63	150	14	3.30	\$451
GCNTLG36P	5.25 x 32 x 27.63	100	27	3.30	\$896

32" long with double post plastic elliptical column cover, leveling glides and end caps. **For assembly with 36" tops.**

- For a single leg, order **GCNTLEG36**.
- For a pair of legs (set of 2), order **GCNTLG36P**.
- Chrome (CH) is available (on foot only). **ADD \$70.00** list for model GCNTLEG36 and **\$140.00** list for model GCNTLG36P.

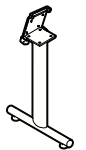

Flip Top "T" Leg

CNTFLEG18	5.25 x 18 x 27.63	150	10	2.40	\$388
-----------	-------------------	-----	----	------	--------------

18" long with plastic elliptical column cover, leveling glides and end caps. **For assembly with 20" deep rectangular and square tops only.** Hinged plate with locking mechanism to lock in open or closed position. Cannot be installed with thumbscrews.

- *Can not be used when modesty panels and wire management are attached to worksurface tops.*
- List Price is per **each leg**.
- Chrome (CH) is available (on foot only). **ADD \$70.00** list

Required Specifications
Leg Finish

T LEGS



Flip Top "T" Leg

MODEL#	DIMENSIONS	FREIGHT CLASS	WT/LBS.	CUBIC FT.	LIST PRICE
	D x W x H				
CNTFLEG24	6.5 x 20 x 27.62	150	10	2.40	\$388

20" long with plastic elliptical column cover, leveling glides and end caps. **For assembly with 24" deep rectangular and square tops only.** Hinged plate with locking mechanism to lock in open or closed position. Cannot be installed with thumbscrews.

- *Can not be used when modesty panels and wire management are attached to worksurface tops.*
- *List Price is per **each leg**.*
- Chrome (CH) is available (on foot only). **ADD \$70.00** list

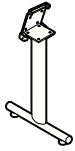

Flip Top "T" Leg

CNTFLEG30	6.5 x 26 x 27.62	150	14	3	\$409
-----------	------------------	-----	----	---	--------------

26" long with plastic elliptical column cover, leveling glides and end caps. **For assembly with 30" deep rectangular and square tops only.** Hinged plate with locking mechanism to lock in open or closed position. Cannot be installed with thumbscrews.

- *Can not be used when modesty panels and wire management are attached to worksurface tops.*
- *List Price is per **each leg**.*
- Chrome (CH) is available (on foot only). **ADD \$70.00** list

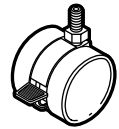

Braking Caster

CNCB	0 x 0 x 1.5	70	1	.15	\$44
------	-------------	----	---	-----	-------------

1 1/2" dual wheel manual locking caster. **Set of 2.** Suggested for hard floor surfaces and industrial carpeting. Casters are fully interchangeable with glides. Black only.

- *For use with ConnecTABLES units only.*
- *Casters DO NOT affect table height.*

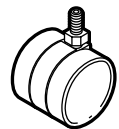

Caster

CNC1	0 x 0 x 1.5	70	1	.15	\$37
------	-------------	----	---	-----	-------------

1 1/2" dual wheel caster. **Set of 2.** Non-Locking. Suggested for hard floor surfaces and industrial carpeting. Casters are fully interchangeable with glides. Black only.

- *For use with ConnecTABLES units only.*
- *Casters DO NOT affect table height.*



Thumbscrews

CNTS	1.25 x 1.25 x 1.5	70	1	.15	\$27
------	-------------------	----	---	-----	-------------

Triangular thumbscrew with 3/4" steel thread. Set of 4. Can be used in place of factory supplied screws to allow installation of "T" legs to tops without tools. Black only.

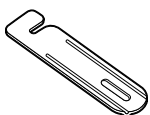

Ganging Connector

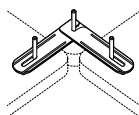

CNGFP	5 x 2.5 x 1.13	70	.20	.10	\$47
-------	----------------	----	-----	-----	-------------

Black epoxy coated 13 gauge steel with 2 thumbscrews included. Used to connect tabletops together for additional stability or for connecting freestanding tops together. Holes with steel inserts are located in the corner of all tops to accommodate this plate. **Sold individually.**

Required Specifications

Leg Finish