



Get Your Bespoke Office Design Today

We'll Get You The Right Office Furniture

Call Now (856)-368-9085

Call Now To Order (856) 368-9085

50% OFF Sale On Now

Nationwide Delivery and Installation

Office Doctor Discount Office Furniture

www.OfficeDr.com 856-368-9085

Global Sale On Now

Take 45% Off the List Prices in this PDF

Call 856-368-9085 Now

Free Layout & Design Service

FreeFit Benching Series



WORKSURFACES **MODEL#** **DIMENSIONS** **FREIGHT CLASS** **WT/LBS.** **CUBIC FT.** **LIST PRICE** **HP ADD**

D x W x H

FTWR2328	23 x 28 x 1	70	20	1.16	\$225	\$68
FTWR2334	23 x 34 x 1	70	24	1.40	\$249	\$76
FTWR2340	23 x 40 x 1	70	28	1.64	\$319	\$104
FTWR2346	23 x 46 x 1	70	31	1.84	\$427	\$128
FTWR2352	23 x 52 x 1	70	36	2.08	\$457	\$145
FTWR2358	23 x 58 x 1	70	40	2.32	\$510	\$162
FTWR2364	23 x 64 x 1	70	44	2.56	\$534	\$168
FTWR2370	23 x 70 x 1	85	48	3.80	\$577	\$179
FTWR2376	23 x 76 x 1	70	52	3.03	\$582	\$185
FTWR2382	23 x 82 x 1	70	56	3.27	\$629	\$193

FTWR2928	29 x 28 x 1	70	25	1.46	\$261	\$83
FTWR2934	29 x 34 x 1	70	30	1.76	\$305	\$96
FTWR2940	29 x 40 x 1	70	35	2.06	\$427	\$132
FTWR2946	29 x 46 x 1	70	40	2.32	\$509	\$145
FTWR2952	29 x 52 x 1	70	45	2.62	\$521	\$145
FTWR2958	29 x 58 x 1	70	50	2.92	\$532	\$168
FTWR2964	29 x 64 x 1	70	55	3.22	\$555	\$181
FTWR2970	29 x 70 x 1	70	60	3.52	\$582	\$186
FTWR2976	29 x 76 x 1	70	65	3.83	\$609	\$192
FTWR2982	29 x 82 x 1	70	71	4.13	\$677	\$211

FTWR3528	35 x 28 x 1	70	30	1.76	\$270	\$86
FTWR3534	35 x 34 x 1	70	35	2	\$317	\$99
FTWR3540	35 x 40 x 1	70	40	2.50	\$444	\$138
FTWR3546	35 x 46 x 1	70	48	2.80	\$578	\$145
FTWR3552	35 x 52 x 1	70	54	3.16	\$640	\$164
FTWR3558	35 x 58 x 1	70	60	3.52	\$712	\$179
FTWR3564	35 x 64 x 1	70	67	3.89	\$776	\$198
FTWR3570	35 x 70 x 1	70	73	4.25	\$844	\$213
FTWR3576	35 x 76 x 1	70	79	4.62	\$906	\$230
FTWR3582	35 x 82 x 1	70	85	4.98	\$976	\$245



Rectangular Worksurfaces

Rectangular worksurfaces are non-handed and can be interchanged on site. For 23" deep worksurfaces, use FT52xx24 or FT62xx24. For 29" deep worksurfaces, use FT52xx30 or FT62xx30. For 35" deep worksurfaces, use FT52xx30 or FT62xx30.

• **35" deep worksurfaces cannot be used with Back-to-Back bases.**

• For back-to-back bases, please use the following chart:

FTWR(23/29)46, FT54BSF/FT64BSF	FTWR(23/29)64, FT54BLF/FT64BLF
FTWR(23/29)52, FT54BSF/FT64BSF	FTWR(23/29)72, FT54BLF/FT64BLF
FTWR(23/29)58, FT54BSF/FT64BSF	FTWR(23/29)76, FT54BLF/FT64BLF
	FTWR(23/29)82, FT54BLF/FT64BLF

FTWMR5460	54 x 60 x 1	70	96	5.63	\$850	\$328
FTWMR5466	54 x 66 x 1	70	106	6.19	\$927	\$360
FTWMR5472	54 x 72 x 1	70	115	6.75	\$1004	\$394
FTWMR5478	54 x 78 x 1	70	125	7.31	\$1078	\$427
FTWMR5484	54 x 84 x 1	70	135	7.88	\$1155	\$459
FTWMR5490	54 x 90 x 1	70	144	8.44	\$1235	\$492
FTWMR5496	54 x 96 x 1	70	154	9	\$1312	\$524

FTWMR6060	60 x 60 x 1	70	107	6.25	\$931	\$366
FTWMR6066	60 x 66 x 1	70	118	6.88	\$1018	\$403
FTWMR6072	60 x 72 x 1	70	128	7.50	\$1102	\$439
FTWMR6078	60 x 78 x 1	70	139	8.13	\$1187	\$473
FTWMR6084	60 x 84 x 1	70	150	8.75	\$1271	\$510
FTWMR6090	60 x 90 x 1	70	160	9.38	\$1357	\$547
FTWMR6096	60 x 96 x 1	70	171	10	\$1440	\$583



Media Table Top

For tables FTWMR5460 and 6060, use FTM5B2BSF standard range or FTM6B2BSF extended range base. For all other tables, use FTM5B2BLF standard range or FTM6B2BLF extended range base

Required specifications

Top finish
Edge finish

Optional specifications

HP laminate
Grommet

WORKSURFACES



Rectangular Return Worksurfaces

MODEL#	DIMENSIONS D x W x H	FREIGHT CLASS	WT/LBS.	CUBIC FT.	LIST PRICE	HP ADD
FTWRR2329	23 x 29 x 1	70	20	1.16	\$272	\$68
FTWRR2335	23 x 35 x 1	70	24	1.40	\$368	\$81
FTWRR2341	23 x 41 x 1	70	28	1.64	\$406	\$107
FTWRR2347	23 x 47 x 1	70	32	1.88	\$427	\$128
FTWRR2353	23 x 53 x 1	70	36	2.12	\$457	\$145
FTWRR2359	23 x 59 x 1	70	40	2.36	\$503	\$162
FTWRR2929	29 x 29 x 1	70	25	1.46	\$340	\$84
FTWRR2935	29 x 35 x 1	70	30	1.76	\$503	\$97
FTWRR2941	29 x 41 x 1	70	35	2.06	\$503	\$136
FTWRR2947	29 x 47 x 1	70	40	2.36	\$509	\$145
FTWRR2953	29 x 53 x 1	70	46	2.67	\$521	\$145
FTWRR2959	29 x 59 x 1	70	51	2.97	\$607	\$168

Rectangular return worksurfaces are non-handed and can be interchanged on site. Includes two flat brackets for connection. For use with FT51SR/LR or FT61SR/LR. To determine the appropriate return base, use the following chart:

Main Surface	Return Surface	Return Base
FTWR23xx	FTWRR(23/29)29	FT51/61SR
FTWR23xx	FTWRR(23/29)35	FT51/61SR
FTWR23xx	FTWRR(23/29)41	FT51/61SR
FTWR23xx	FTWRR(23/29)47	FT51/61LR
FTWR23xx	FTWRR(23/29)53	FT51/61LR
FTWR23xx	FTWRR(23/29)59	FT51/61LR
FTWR29xx	FTWRR(23/29)29	FT51/61SR
FTWR29xx	FTWRR(23/29)35	FT51/61SR
FTWR29xx	FTWRR(23/29)41	FT51/61LR
FTWR29xx	FTWRR(23/29)47	FT51/61LR
FTWR29xx	FTWRR(23/29)53	FT51/61LR
FTWR29xx	FTWRR(23/29)59	FT51/61LR

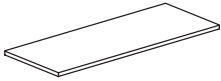

Rectangular End of Run Worksurfaces

FTWR2351	23 x 51 x 1	70	40	2.02	\$498	\$162
FTWR2362	23 x 62 x 1	70	44	2.50	\$523	\$168
FTWR2951	29 x 51 x 1	70	50	2.54	\$523	\$168
FTWR2962	29 x 62 x 1	70	55	3.15	\$535	\$270

Rectangular return worksurfaces are non-handed and can be interchanged on site.

- For 23" deep worksurfaces, use with FT52xx24 or FT62xx24.
- For 29" deep worksurfaces, use with FT52xx30 or FT62xx30.
- For back-to-back bases, please use the following chart:
FTWR(23/29)51, FT52BSF24/30 or FT62BSF24/30
FTWR(23/29)62, FT52BLF24/30 or FT62BLF24/30

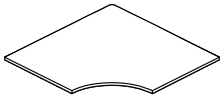

90° Corner Worksurface

FTWCC234023	40 x 40 x 1	60	80	1.5	\$827	\$83
FTWCC234623	46 x 46 x 1	60	95	2	\$851	\$85
FTWCC235223	52 x 52 x 1	70	80	4.69	\$987	\$85
FTWCC235823	58 x 58 x 1	70	100	5.84	\$1263	\$128
FTWCC294029	40 x 40 x 1	60	80	1.5	\$827	\$83
FTWCC294629	46 x 46 x 1	70	63	3.67	\$838	\$86
FTWCC295229	52 x 52 x 1	70	80	4.69	\$987	\$103
FTWCC295829	58 x 58 x 1	70	100	5.84	\$1263	\$128

For tables that connect with 23" deep worksurfaces, use with FT539FS24CL or FT639FS24CL. For tables that connect with 29" deep worksurfaces, use with FT539FS30CL or FT639FS30CL.

Required specifications

Top finish
Edge finish

Optional specifications

HP laminate
Grommet

EXTENDED CORNER WORKSURFACES

MODEL# DIMENSIONS FREIGHT CLASS WT/LBS. CUBIC FT. LIST PRICE HP ADD

D x W x H

FTWEC23584023	58 x 40 x 1	60	115	2.6	\$1114	\$281
FTWEC23644023	64 x 40 x 1	60	127	2.8	\$1238	\$311
FTWEC23704023	70 x 40 x 1	60	138	3.1	\$1353	\$343
FTWEC23764023	76 x 40 x 1	60	150	3.3	\$1445	\$359
FTWEC23824023	82 x 40 x 1	60	162	3.6	\$1533	\$384
FTWEC23584623	58 x 46 x 1	60	115	2.55	\$1164	\$292
FTWEC23644623	64 x 46 x 1	60	127	2.81	\$1294	\$326
FTWEC23704623	70 x 46 x 1	60	138	3.07	\$1415	\$358
FTWEC23764623	76 x 46 x 1	60	150	3.34	\$1510	\$378
FTWEC23824623	82 x 46 x 1	60	162	3.6	\$1602	\$403
FTWEC23585223	58 x 52 x 1	60	130	2.88	\$1198	\$304
FTWEC23645223	64 x 52 x 1	60	143	3.18	\$1333	\$337
FTWEC23705223	70 x 52 x 1	60	156	3.48	\$1457	\$368
FTWEC23765223	76 x 52 x 1	60	170	3.77	\$1555	\$389
FTWEC23825223	82 x 52 x 1	60	183	4.07	\$1648	\$415
FTWEC23645823	64 x 58 x 1	60	160	3.54	\$1372	\$345
FTWEC23705823	70 x 58 x 1	60	174	3.88	\$1501	\$379
FTWEC23765823	76 x 58 x 1	60	189	4.21	\$1602	\$402
FTWEC23825823	82 x 58 x 1	60	204	4.54	\$1698	\$431
FTWEC29584029	58 x 40 x 1	60	115	2.2	\$1159	\$291
FTWEC29644029	64 x 40 x 1	60	127	2.4	\$1290	\$322
FTWEC29704029	70 x 40 x 1	60	138	2.7	\$1407	\$356
FTWEC29764029	76 x 40 x 1	60	150	2.9	\$1502	\$373
FTWEC29824029	82 x 40 x 1	60	162	3.1	\$1593	\$401
FTWEC29584629	58 x 46 x 1	60	115	2.55	\$1212	\$305
FTWEC29644629	64 x 46 x 1	60	127	2.81	\$1346	\$338
FTWEC29704629	70 x 46 x 1	60	138	3.07	\$1471	\$373
FTWEC29764629	76 x 46 x 1	60	150	3.34	\$1570	\$391
FTWEC29824629	82 x 46 x 1	60	152	3.6	\$1665	\$418
FTWEC29585229	58 x 52 x 1	60	130	2.88	\$1248	\$316
FTWEC29645229	64 x 52 x 1	60	143	3.18	\$1385	\$350
FTWEC29705229	70 x 52 x 1	60	156	3.48	\$1516	\$382
FTWEC29765229	76 x 52 x 1	60	170	3.77	\$1616	\$403
FTWEC29825229	82 x 52 x 1	60	183	4.07	\$1716	\$432
FTWEC29645829	64 x 58 x 1	60	160	3.54	\$1427	\$360
FTWEC29705829	70 x 58 x 1	60	174	3.88	\$1562	\$393
FTWEC29765829	76 x 58 x 1	60	189	4.21	\$1665	\$417
FTWEC29825829	82 x 58 x 1	60	204	4.54	\$1766	\$444

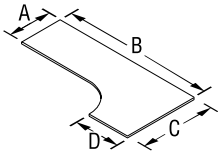

Ext. 90° Corner Worksurface, Left

For tables that connect with 23" deep (A and D) worksurfaces, use with FT539F(S/L)24CL or FT539F(S/L)24CL bases. For tables that connect with 29" deep (A and D) worksurfaces, use with FT539F(S/L)30CL or FT639F(S/L)30CL bases. Must use with FTWRExxxx return surfaces only.

Required specifications

Top finish
Edge finish

Optional specifications

HP laminate
Grommet

MODEL# DIMENSIONS FREIGHT CLASS WT/LBS. CUBIC FT. LIST PRICE HP ADD

D x W x H

FTWEC23405823	58 x 40 x 1	60	115	2.6	\$1114	\$281
FTWEC23406423	64 x 40 x 1	60	127	2.8	\$1238	\$311
FTWEC23407023	70 x 40 x 1	60	138	3.1	\$1353	\$343
FTWEC23407623	76 x 40 x 1	60	150	3.3	\$1445	\$359
FTWEC23408223	82 x 40 x 1	60	162	3.6	\$1533	\$384
FTWEC23465823	58 x 46 x 1	60	115	2.55	\$1164	\$292
FTWEC23466423	64 x 46 x 1	60	127	2.81	\$1294	\$326
FTWEC23467023	70 x 46 x 1	60	138	3.07	\$1415	\$358
FTWEC23467623	76 x 46 x 1	60	150	3.34	\$1510	\$378
FTWEC23468223	82 x 46 x 1	60	162	3.6	\$1602	\$403
FTWEC23525823	58 x 52 x 1	60	130	2.88	\$1198	\$304
FTWEC23526423	64 x 52 x 1	60	143	3.18	\$1333	\$337
FTWEC23527023	70 x 52 x 1	60	156	3.48	\$1457	\$368
FTWEC23527623	76 x 52 x 1	60	170	3.77	\$1555	\$389
FTWEC23528223	82 x 52 x 1	60	183	4.07	\$1648	\$415
FTWEC23586423	64 x 58 x 1	60	160	3.54	\$1372	\$345
FTWEC23587023	70 x 58 x 1	60	174	3.88	\$1501	\$379
FTWEC23587623	76 x 58 x 1	60	189	4.21	\$1602	\$402
FTWEC23588223	82 x 58 x 1	60	204	4.54	\$1698	\$431

FTWEC29405829	58 x 40 x 1	60	115	2.2	\$1159	\$291
FTWEC29406429	64 x 40 x 1	60	127	2.4	\$1290	\$322
FTWEC29407029	70 x 40 x 1	60	138	2.7	\$1407	\$356
FTWEC29407629	76 x 40 x 1	60	127	2.4	\$1502	\$373
FTWEC29408229	82 x 40 x 1	60	162	3.1	\$1593	\$401
FTWEC29465829	58 x 46 x 1	60	115	2.55	\$1212	\$305
FTWEC29466429	64 x 46 x 1	60	127	2.81	\$1346	\$338
FTWEC29467029	70 x 46 x 1	60	138	3.07	\$1471	\$373
FTWEC29467629	76 x 46 x 1	60	150	3.34	\$1570	\$391
FTWEC29468229	82 x 46 x 1	60	162	3.6	\$1665	\$418
FTWEC29525829	58 x 52 x 1	60	130	2.88	\$1248	\$316
FTWEC29526429	64 x 52 x 1	60	143	3.18	\$1385	\$350
FTWEC29527029	70 x 52 x 1	60	156	3.48	\$1516	\$382
FTWEC29527629	76 x 52 x 1	60	170	3.77	\$1616	\$403
FTWEC29528229	82 x 52 x 1	60	183	4.07	\$1716	\$432
FTWEC29586429	64 x 58 x 1	60	160	3.54	\$1427	\$360
FTWEC29587029	70 x 58 x 1	60	174	3.88	\$1562	\$393
FTWEC29587629	76 x 58 x 1	60	189	4.21	\$1665	\$417
FTWEC29588229	82 x 58 x 1	60	204	4.54	\$1766	\$444

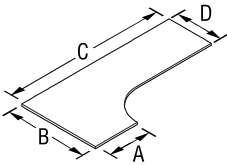

Ext. 90° Corner Worksurface, Right

For tables that connect with 23" deep (A and D) worksurfaces, use with FT539F(S/L)24CL or FT539F(S/L)24CL bases. For tables that connect with 29" deep (A and D) worksurfaces, use with FT539F(S/L)30CL or FT639F(S/L)30CL bases. Must use with FTWRExxxx return surfaces only.

FTWRE2324	23 x 24 x 1	70	16	0.96	\$211	\$68
FTWRE2330	23 x 30 x 1	70	20	1.2	\$229	\$68
FTWRE2336	23 x 36 x 1	70	25	1.44	\$255	\$81
FTWRE2924	29 x 24 x 1	70	21	1.21	\$250	\$74
FTWRE2930	29 x 30 x 1	70	26	1.51	\$266	\$84
FTWRE2936	29 x 36 x 1	70	31	1.81	\$308	\$97

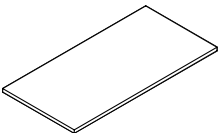

Rectangular Extension**
Return Worksurface

Worksurfaces to be used only with Extended 90° Corner Worksurfaces.

- FTWRE23 to be used with FTWEC23xxxx23
- FTWRE29 to be used with FTWEC29xxxx29

Required specifications

Top finish
Edge finish

Optional specifications

HP laminate
Grommet

BASES

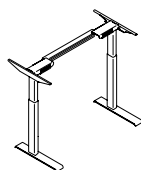

Standard Range Base*

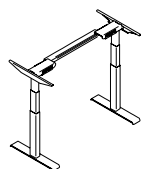

Extended Range Base*

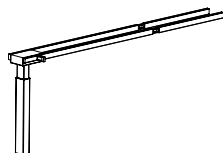

Standard Range Return Kit

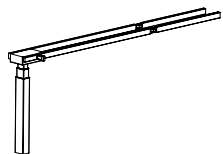

Extended Range Return Kit

MODEL# DIMENSIONS FREIGHT CLASS WT./LBS. CUBIC FT. LIST PRICE

D x W x H

FT52BF24	24 x 30-42 x 27.5-47	60	67	1.47	\$1255
FT52SF24	24 x 48-60 x 27.5-47	60	67	1.47	\$1382
FT52LF24	24 x 66-84 x 27.5-47	60	67	1.47	\$1388
FT52BF30	30-36 x 30-42 x 27.5-47	60	67	1.47	\$1265
FT52SF30	30-36 x 48-60 x 27.5-47	60	67	1.47	\$1392
FT52LF30	30-36 x 66-84 x 27.5-47	60	67	1.47	\$1398

Kit includes one beam, two cantilevers, two standard range columns, and two C or T styled feet. **BF** indicates base frame for 30" to 42" tables. **SF** indicates small frame for 48" to 60" tables. **LF** indicates large frame: 66" to 84" tables. For 23" deep worksurfaces, use 24" leg. For 29" and 35" deep worksurface, use 30" leg. For enhanced collision detection, an Anti Collision Desk Sensor is included with every base. Standard up/down controller with 2 memory positions, reminder settings + Bluetooth capability is standard - specify **(S)**. For a Display controller with height readout, 4 memory positions, reminder settings + Bluetooth capabilities, specify **(D)**, add **\$59** list. Specify paint finish: Black (**BLK**), Charcoal (**CHR**), Designer White (**DWT**), Fog (**FOG**), Nevada (**NEV**), Silver (**SIL**), Taupe (**TPE**), Tungsten (**TUN**). UL Listed: UL 962.

FT62BF24	24 x 30-42 x 22.5-48.5	60	67	1.47	\$1341
FT62SF24	24 x 48-60 x 22.5-48.5	60	67	1.47	\$1473
FT62LF24	24 x 66-84 x 22.5-48.5	60	67	1.47	\$1480
FT62BF30	30-36 x 30-42 x 22.5-48.5	60	67	1.47	\$1351
FT62SF30	30-36 x 48-60 x 22.5-48.5	60	67	1.47	\$1485
FT62LF30	30-36 x 66-84 x 22.5-48.5	60	67	1.47	\$1489

Kit includes one beam, two cantilevers, two extended range columns, and two C or T styled feet. **BF** indicates base frame for 30" to 42" tables. **SF** indicates small frame for 48" to 60" tables. **LF** indicates large frame: 66" to 84" tables. For 23" deep worksurfaces, use 24" leg. For 29" and 35" deep worksurface, use 30" leg. For enhanced collision detection, an Anti Collision Desk Sensor is included with every base. Standard up/down controller with 2 memory positions, reminder settings + Bluetooth capability is standard - specify **(S)**. For a Display controller with height readout, 4 memory positions, reminder settings + Bluetooth capabilities, specify **(D)**, add **\$59** list. Specify paint finish: Black (**BLK**), Charcoal (**CHR**), Designer White (**DWT**), Fog (**FOG**), Nevada (**NEV**), Silver (**SIL**), Taupe (**TPE**), Tungsten (**TUN**). UL Listed: UL 962.

FT51SRNL	-- x 24-48 x 27.5-47	60	61	1.47	\$846
FT51LRNL	-- x 54-72 x 27.5-47	60	61	1.47	\$863

Kit includes one beam, one cantilever, one standard range columns, and one pad foot. See chart on page 612 to determine whether SR or LR kit is required. For 23" deep worksurfaces, use 24" return. For 29" and 35" deep worksurface, use 30" return. Specify paint finish: Black (**BLK**), Charcoal (**CHR**), Designer White (**DWT**), Fog (**FOG**), Nevada (**NEV**), Silver (**SIL**), Taupe (**TPE**), Tungsten (**TUN**). UL Listed: UL 962.

- When using the return kit for a 23"d return and a 29"/35" deep desk, a new foot must be ordered separately. See FTFOOT24TL/CL (page 625) for specification information.

FT61SRNL	-- x 24-48 x 22.5-48.5	60	61	1.47	\$890
FT61LRNL	-- x 54-72 x 22.5-48.5	60	61	1.47	\$908

Kit includes one beam, one cantilever, one standard range columns, and one pad foot. See chart on page 612 to determine whether SR or LR kit is required. For 23" deep worksurfaces, use 24" return. For 29" and 35" deep worksurface, use 30" return. Specify paint finish: Black (**BLK**), Charcoal (**CHR**), Designer White (**DWT**), Fog (**FOG**), Nevada (**NEV**), Silver (**SIL**), Taupe (**TPE**), Tungsten (**TUN**). UL Listed: UL 962.

- When using the return kit for a 23"d return and a 29"/35" deep desk, a new foot must be ordered separately. See FTFOOT24TL/CL (page 625) for specification information.

Required specifications

Base finish
Leg style*

Optional specifications

Digital handset

BASES

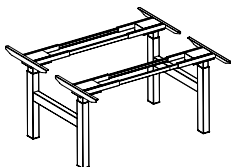

Back-to-Back Standard Range Base

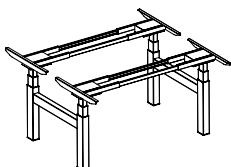

Back-to-Back Extended Range Base

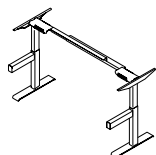

Standard Range Single Frame

MODEL#	DIMENSIONS D x W x H	FREIGHT CLASS	WT/LBS.	CUBIC FT.	LIST PRICE
FT54BSFNL	24 x 24-48 x 27.5-47	60	123	2.94	\$3080
FT54BLFNL	24 x 54-72 x 27.5-47	60	123	2.94	\$3089

Back-to-back height adjustable bases includes four height adjustable columns with pad feet, two sets of cross rails for surface support and two short beams to attach the columns back-to-back. Combine with surfaces & trough kits (sold separately) to create a complete workstation. For 50.5" depth, use two x 23" deep worksurfaces. For 62.5" depth, use two x 29" deep worksurfaces. **30" or larger depth worksurfaces cannot be used with Back to Back bases.** Duplex receptacles are not included, please specify separately. For enhanced collision detection, an Anti Collision Desk Sensor is included with every base. Standard up/down controller with 2 memory positions, reminder settings + Bluetooth capability is standard - specify **(S)**. For a Display controller with height readout, 4 memory positions, reminder settings + Bluetooth capabilities, specify **(D)**, add **\$117** list. Specify paint finish: Black **(BLK)**, Charcoal **(CHR)**, Designer White **(DWT)**, Fog **(FOG)**, Nevada **(NEV)**, Silver **(SIL)**, Taupe **(TPE)**, Tungsten **(TUN)**. UL Listed: UL 962.

FT64BSFNL	10 x -- x 22.5-48.5	60	123	2.94	\$3253
FT64BLFNL	10 x -- x 22.5-48.5	60	123	2.94	\$3264

Back-to-back height adjustable bases includes four height adjustable columns with pad feet, two sets of cross rails for surface support and two short beams to attach the columns back-to-back. Combine with surfaces & trough kits (sold separately) to create a complete workstation. For 50.5" depth, use two x 23" deep worksurfaces. For 62.5" depth, use two x 29" deep worksurfaces. **30" or larger depth worksurfaces cannot be used with Back to Back bases.** Duplex receptacles are not included, please specify separately. For enhanced collision detection, an Anti Collision Desk Sensor is included with every base. Standard up/down controller with 2 memory positions, reminder settings + Bluetooth capability is standard - specify **(S)**. For a Display controller with height readout, 4 memory positions, reminder settings + Bluetooth capabilities, specify **(D)**, add **\$117** list. Specify paint finish: Black **(BLK)**, Charcoal **(CHR)**, Designer White **(DWT)**, Fog **(FOG)**, Nevada **(NEV)**, Silver **(SIL)**, Taupe **(TPE)**, Tungsten **(TUN)**. UL Listed: UL 962.

FT52BSF24	24 x -- x 27.5-47	60	72	1.47	\$1741
FT52BLF24	24 x -- x 27.5-47	60	72	1.47	\$1751
FT52BSF30	30 x -- x 27.5-47	60	72	1.47	\$1806
FT52BLF30	30 x -- x 27.5-47	60	72	1.47	\$1816

Single sided height adjustable bases includes two height adjustable columns with "T" feet, one set of cross rails for surface support and two short beams to attach the columns to a trough kit. Combine with single surfaces & trough kits (sold separately) to create a complete workstation. Use 23" deep worksurfaces with FT52BSF24 + FT52BLF24. Use 29" deep worksurfaces with FT52BSF30 + FT52BLF30. **30" or larger depth worksurfaces cannot be used with benching bases.** Duplex receptacles are not included, please specify separately. For enhanced collision detection, an Anti Collision Desk Sensor is included with every base. Standard up/down controller with 2 memory positions, reminder settings + Bluetooth capability is standard - specify **(S)**. For a Display controller with height readout, 4 memory positions, reminder settings + Bluetooth capabilities, specify **(D)**, add **\$117** list. Specify paint finish: Black **(BLK)**, Charcoal **(CHR)**, Designer White **(DWT)**, Fog **(FOG)**, Nevada **(NEV)**, Silver **(SIL)**, Taupe **(TPE)**, Tungsten **(TUN)**. UL Listed: UL 962.

Required specifications

Base finish
Leg style*

Optional specifications

Digital handset

BASES

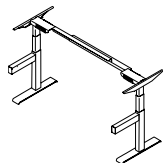

Extended Range Single Frame

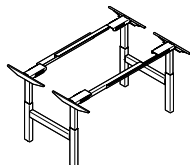

Standard Range Media Table Base

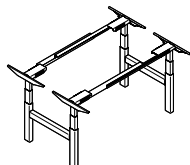

Extended Range Media Table Base

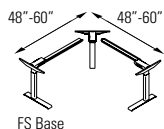

FS Base

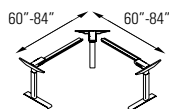

FL Base

Standard Range 90° Base, Equal Sides

MODEL# DIMENSIONS FREIGHT CLASS WT./LBS. CUBIC FT. LIST PRICE

D x W x H

FT62BSF24	24 x -- x 22.5-48.5	60	72	1.47	\$1887
FT62BLF24	24 x -- x 22.5-48.5	60	72	1.47	\$1892
FT62BSF30	30 x -- x 22.5-48.5	60	72	1.47	\$1897
FT62BLF30	30 x -- x 22.5-48.5	60	72	1.47	\$1903

Single sided height adjustable bases includes two height adjustable columns with "T" feet, one set of cross rails for surface support and two short beams to attach the columns to a trough kit. Combine with single surfaces & trough kits (sold separately) to create a complete workstation. Use 23" deep worksurfaces with FT62BSF24 + FT62BLF24. Use 29" deep worksurfaces with FT62BSF30 + FT62BLF30. **30" or larger depth worksurfaces cannot be used with benching bases.** Duplex receptacles are not included, please specify separately. For enhanced collision detection, an Anti Collision Desk Sensor is included with every base. Standard up/down controller with 2 memory positions, reminder settings + Bluetooth capability is standard - specify **(S)**. For a Display controller with height readout, 4 memory positions, reminder settings + Bluetooth capabilities, specify **(D)**, add **\$117** list. Specify paint finish: Black **(BLK)**, Charcoal **(CHR)**, Designer White **(DWT)**, Fog **(FOG)**, Nevada **(NEV)**, Silver **(SIL)**, Taupe **(TPE)**, Tungsten **(TUN)**. UL Listed: UL 962.

FTM5B2BSF	54-60 x 60 x 27.5-47	60	123	2.94	\$3080
FTM5B2BLF	54-60 x 60 x 27.5-47	60	123	2.94	\$3089

Kit includes two beams, four cantilevers, four standard range columns and two controllers. SF indicates small base for 60" sided tables. LF indicates large base for 66" to 84" sided tables. For enhanced collision detection, an Anti Collision Desk Sensor is included with every base. Standard up/down controller with 2 memory positions, reminder settings + Bluetooth capability is standard - specify **(S)**. For a Display controller with height readout, 4 memory positions, reminder settings + Bluetooth capabilities, specify **(D)**, add **\$117** list. Specify paint finish: Black **(BLK)**, Charcoal **(CHR)**, Designer White **(DWT)**, Fog **(FOG)**, Nevada **(NEV)**, Silver **(SIL)**, Taupe **(TPE)**, Tungsten **(TUN)**. UL Listed: UL 962.

FTM6B2BSF	54-60 x 60 x 22.5-48.5	60	123	2.94	\$3253
FTM6B2BLF	54-60 x 60 x 22.5-48.5	60	123	2.94	\$3264

Kit includes two beams, four cantilevers, four extended range columns and two controllers. SF indicates small base for 60" sided tables. LF indicates large base for 66" to 84" sided tables. For enhanced collision detection, an Anti Collision Desk Sensor is included with every base. Standard up/down controller with 2 memory positions, reminder settings + Bluetooth capability is standard - specify **(S)**. For a Display controller with height readout, 4 memory positions, reminder settings + Bluetooth capabilities, specify **(D)**, add **\$117** list. Specify paint finish: Black **(BLK)**, Charcoal **(CHR)**, Designer White **(DWT)**, Fog **(FOG)**, Nevada **(NEV)**, Silver **(SIL)**, Taupe **(TPE)**, Tungsten **(TUN)**. UL Listed: UL 962.

FT539FS24CL	54-60 x 42-60 x 27.5-47	60	101	1.47	\$2011
FT539FS30CL	54-60 x 42-60 x 27.5-47	60	101	1.47	\$2023
FT539FL24CL	66-84 x 66-84 x 27.5-47	60	101	1.47	\$2047
FT539FL30CL	66-84 x 66-84 x 27.5-47	60	101	1.47	\$2030

Kit includes two equal length beams, three cantilevers, one standard range corner column, two standard range columns, and two C styled feet. **FS** indicates small base for 54" to 60" sided tables. **FL** indicates large base: 66" to 84" sided tables. For 23" deep worksurfaces, use 24" CL leg. For 29" and 35" deep work surface, use 30" CL leg. For enhanced collision detection, an Anti Collision Desk Sensor is included with every base.

Standard up/down controller with 2 memory positions, reminder settings + Bluetooth capability is standard - specify **(S)**. For a Display controller with height readout, 4 memory positions, reminder settings + Bluetooth capabilities, specify **(D)**, add **\$59** list. Specify paint finish: Black **(BLK)**, Charcoal **(CHR)**, Designer White **(DWT)**, Fog **(FOG)**, Nevada **(NEV)**, Silver **(SIL)**, Taupe **(TPE)**, Tungsten **(TUN)**. UL Listed: UL 962.

- When using a 23" d return with the FT539FS30CL/LF30CL a 24" foot must be ordered separately. See FTFOOT24TL/CL (page 625) for specification information.

Required specifications

Base finish

Optional specifications

Digital handset

BASES

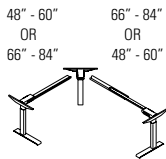

**Standard Range 90° Base,
Unequal Sides**

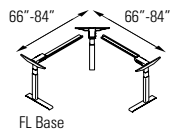
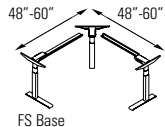

Extended Range 90° Base, Equal Sides*

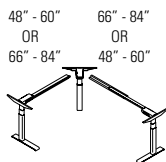

**Extended Range 90° Base,
Unequal Sides***

MODEL#	DIMENSIONS D x W x H	FREIGHT CLASS	WT/LBS.	CUBIC FT.	LIST PRICE
FT539FSL24CL	66-84 x 42-60 x 27.5-47	60	101	1.47	\$2030
FT539FSL30CL	66-84 x 42-60 x 27.5-47	60	101	1.47	\$2040

Kit includes two beams (one small, one large), three cantilevers, one standard range corner column, two standard range columns, and two C styled feet. For 23" deep worksurfaces, use 24" CL leg. For 29" and 35" deep worksurface, use 30" CL leg. For enhanced collision detection, an Anti Collision Desk Sensor is included with every base.

Standard up/down controller with 2 memory positions, reminder settings + Bluetooth capability is standard - specify **(S)**. For a Display controller with height readout, 4 memory positions, reminder settings + Bluetooth capabilities, specify **(D)**, add **\$59** list. Specify paint finish: Black (**BLK**), Charcoal (**CHR**), Designer White (**DWT**), Fog (**FOG**), Nevada (**NEV**), Silver (**SIL**), Taupe (**TPE**), Tungsten (**TUN**). UL Listed: UL 962.

- When using a 23"d return with the FT539FSL30CL a 24" foot must be ordered separately. See FTFOOT24TL/CL (page 625) for specification information.

FT639FS24CL	48-60 x 42-60 x 22.5-48.5	60	101	1.47	\$2148
FT639FS30CL	48-60 x 42-60 x 22.5-48.5	60	101	1.47	\$2159
FT639FL24CL	66-84 x 66-84 x 22.5-48.5	60	101	1.47	\$2184
FT639FL30CL	66-84 x 66-84 x 22.5-48.5	60	101	1.47	\$2195

Kit includes two equal length beams, three cantilevers, one extended range corner column, two extended range columns, and two C styled feet. **FS** indicates small base for 54" to 60" sided tables. **FL** indicates large base: 66" to 84" sided tables. For 23" deep worksurfaces, use 24" CL leg. For 29" and 35" deep worksurface, use 30" CL leg. For enhanced collision detection, an Anti Collision Desk Sensor is included with every base.

Standard up/down controller with 2 memory positions, reminder settings + Bluetooth capability is standard - specify **(S)**. For a Display controller with height readout, 4 memory positions, reminder settings + Bluetooth capabilities, specify **(D)**, add **\$59** list. Specify paint finish: Black (**BLK**), Charcoal (**CHR**), Designer White (**DWT**), Fog (**FOG**), Nevada (**NEV**), Silver (**SIL**), Taupe (**TPE**), Tungsten (**TUN**). UL Listed: UL 962.

- When using a 23"d return with the FT639FS30CL/LF30CL a 24" foot must be ordered separately. See FTFOOT24TL/CL (page 625) for specification information.

FT639FSL24CL	48-84 x 48-60 x 22.5-48.5	60	101	1.47	\$2166
FT639FSL30CL	48-84 x 48-60 x 22.5-48.5	60	101	1.47	\$2177

Kit includes two beams (one small, one large), three cantilevers, one extended range corner column, two extended range columns, and two C styled feet. For 23" deep worksurfaces, use 24" CL leg. For 29" and 35" deep worksurface, use 30" CL leg. For enhanced collision detection, an Anti Collision Desk Sensor is included with every base.

Standard up/down controller with 2 memory positions, reminder settings + Bluetooth capability is standard - specify **(S)**. For a Display controller with height readout, 4 memory positions, reminder settings + Bluetooth capabilities, specify **(D)**, add **\$59** list. Specify paint finish: Black (**BLK**), Charcoal (**CHR**), Designer White (**DWT**), Fog (**FOG**), Nevada (**NEV**), Silver (**SIL**), Taupe (**TPE**), Tungsten (**TUN**). UL Listed: UL 962.

- When using a 23"d return with the FT639FSL30CL a 24" foot must be ordered separately. See FTFOOT24TL/CL (page 625) for specification information.

Required specifications

Top finish
Base finish
Foot style
Foot configuration

Optional specifications

HP laminate
Digital handset
Grommet
Insulation type

Accessories

Keyboard tray
Power block

LAMINATE LEG SHROUDS

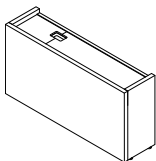

Laminate Leg Shroud, for C-Leg - Left**

MODEL# DIMENSIONS FREIGHT CLASS WT/LBS. CUBIC FT. LIST PRICE

D x W x H

FTB23L	9 x 23 x 18	65	47	2	\$571
FTB29L	9 x 29 x 18	70	55	3	\$591
FTB35L	9 x 35 x 18	70	67	3	\$616

Laminate housing to cover a FreeFit C-leg on the left side. Includes a felt liner at the top. Short side panel is removable to access interior. Specify laminate finish, PVC edge finish and felt finish.

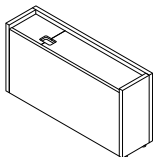

Laminate Leg Shroud, for C-Leg - Right**

FTB23R	9 x 23 x 18	65	47	2	\$571
FTB29R	9 x 29 x 18	70	55	3	\$591
FTB35R	9 x 35 x 18	70	67	3	\$616

Laminate housing to cover a FreeFit C-leg on the right side. Includes a felt liner at the top. Short side panel is removable to access interior. Specify laminate finish, PVC edge finish and felt finish.

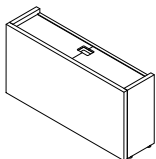

Laminate Leg Shroud for T-Leg**

FTB23	9 x 23 x 18	65	47	2	\$571
FTB29	9 x 29 x 18	70	55	3	\$591
FTB35	9 x 35 x 18	70	67	3	\$616

Laminate housing to cover a FreeFit T-leg. Includes a felt liner at the top. Short side panel is removable to access interior. Specify laminate finish, PVC edge finish and felt finish.

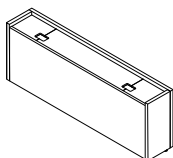

Laminate Leg Shroud for Media Bases

FTB54	9 x 54 x 18	70	110	5	\$1162
FTB64	9 x 64 x 18	70	134	6	\$1352

Laminate shroud for a FreeFit media table base. Includes a felt liner at the top. Side panel is removable to access interior. Specify laminate finish, PVC edge finish and felt finish.

Required specifications

- Laminate finish
- Edge finish
- Felt finish

4-2-2 Wiring Schematic
8-Wire Shared Neutral
"2 + 2" - 2 Utility Circuits, 2 Dedicated

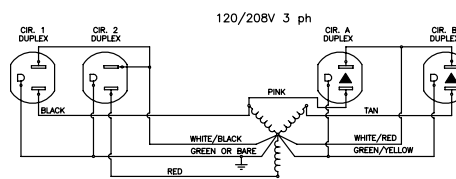
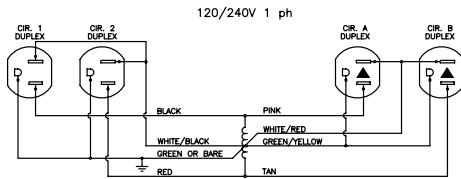

8 Wires	4 Circuits	Receptacles	Specifications
4 Lines (12 ga.) 2 Neutrals (10 ga.) 2 Grounds (12 ga.)	2 Utility circuits 2 Dedicated Circuits	Duplex - Up to 12 duplex receptacles per circuit (Up to 48 per infeed)	System rated for connection to a grounded 120/240 V single phase, 20A, 60Hz or 120/208 V, 3 phase, 20A, 60Hz branch circuit for U.S. and 15A if product is marked with a C-UL Mark. Outlets rated 15A max.

TROUGH KITS

MODEL#

DIMENSIONS

FREIGHT CLASS

WT/LBS.

CUBIC FT.

LIST PRICE



Back-to-Back Trough Kit

FTB2B48KITNB	--	92.5	3.50	.30	\$2422
FTB2B54KITNB	--	92.5	3.50	.30	\$2496
FTB2B60KITNB	--	92.5	3.50	.30	\$2622
FTB2B66KITNB	--	92.5	3.50	.30	\$2672
FTB2B72KITNB	--	92.5	3.50	.30	\$2703

For back-to-back benching applications. Trough kits contain all items needed for a standard back-to-back workstation when combined with the back-to-back height adjustable base and worksurfaces (both sold separately). Kits include two cable chains and one back-to-back power trough with distribution housing included. Specify duplexes separately.

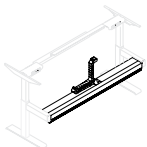

Single Sided Trough Kit

FTSGL48KITNB	--	92.5	3.50	.30	\$1582
FTSGL54KITNB	--	92.5	3.50	.30	\$1658
FTSGL60KITNB	--	92.5	3.50	.30	\$1752
FTSGL66KITNB	--	92.5	3.50	.30	\$1801
FTSGL72KITNB	--	92.5	3.50	.30	\$1852

For single-sided benching applications. Trough kits contain all items needed for a single sided workstation when combined with the single-sided height adjustable base and worksurfaces (both sold separately). Kits include two cable chains and one back-to-back power trough with distribution housing included. Specify duplexes separately.

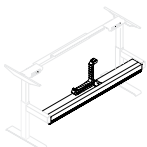

End of Run Trough Kit

FTSGL51T24KITNB	--	92.5	3.50	.30	\$1658
-----------------	----	------	------	-----	---------------

For perpendicular end of run benching applications. Trough kits contain all items needed for a standard back-to-back workstation when combined with the back-to-back height adjustable base and worksurfaces (both sold separately). Kits include two cable chains and one back-to-back power trough with distribution housing included. Specify duplexes separately.

ACCESS DOORS

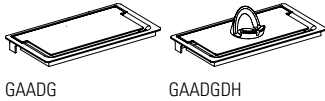

Access Door Module

MODEL# DIMENSIONS FREIGHT CLASS WT/LBS. CUBIC FT. LIST PRICE

D x W x H

GAADG	5.54 x 10.09 x 1.08	--	2	0.04	\$90
GAADGDH	5.54 x 10.09 x 1.08	--	2	0.04	\$97

Soft close door is set back from edge to allow for cable pass thru when closed. Available in all standard base finishes. GAADGDH includes device holder for most mobile phones or tablets. Holder is only available in White. FreeFit can only accommodate one grommet per worksurface.

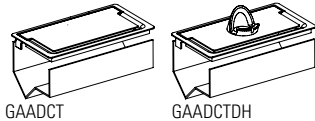

Access Door Module w/Cable Tray

GAADCT	5.54 x 10.09 x 5.07	--	4	0.19	\$145
GAADCTDH	5.54 x 10.09 x 5.07	--	4	0.19	\$153

Soft close door is set back from edge to allow for cable pass thru when closed. Cable tray comes standard with one telecom knockout and platform to mount a power bar. Sides are open for easy access. Available in all standard base finishes. GAADCTDH includes device holder for most mobile phones or tablets. Holder is only available in White. FreeFit can only accommodate one grommet per worksurface.

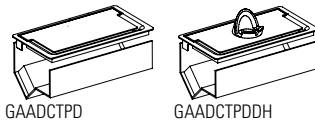

Access Door Module w/Cable Tray and Power Bar

GAADCTPD	5.54 x 10.09 x 6.96	--	4	0.20	\$307
GAADCTPDDH	5.54 x 10.09 x 6.96	--	4	0.20	\$316

Soft close door is set back from edge to allow for cable pass thru when closed. Cable tray comes standard with one telecom knockout and platform to mount a powerbar. Power bar with 3 simplex and 2 USB, CSA Certified. Sides are open for easy access. Available in all standard base finishes. GAADCTPDDH includes device holder for most mobile phones or tablets. Holder is only available in White. FreeFit can only accommodate one grommet per worksurface.

ELECTRICAL COMPONENTS

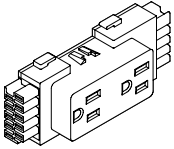

Duplex Receptacles

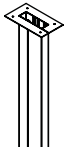

Ceiling Feed Post*



Ceiling Feed Harness

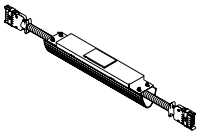

Table to Table Connector*

MODEL#	DIMENSIONS D x W x H	FREIGHT CLASS	WT/LBS.	CUBIC FT.	LIST PRICE
BRTE8D1	1.25 x 4.63 x 2	70	.10	.01	\$42
BRTE8D2	1.25 x 4.63 x 2	70	.10	.01	\$42
BRTE8DA	1.25 x 4.63 x 2	70	.10	.01	\$42
BRTE8DB	1.25 x 4.63 x 2	70	.10	.01	\$42
BRTE8DXW1	1.25 x 4.63 x 2	70	.10	.01	\$59
BRTE8DXW2	1.25 x 4.63 x 2	70	.10	.01	\$59
BRTE8DXWA	1.25 x 4.63 x 2	70	.10	.01	\$59
BRTE8DXWB	1.25 x 4.63 x 2	70	.10	.01	\$59

Snaps into Power Distribution Housing. Up to 13 duplex receptacles per circuit. XW identifies white color plastic, all others standard in black.

- BRTE8D1 / BRTE8DXW1 - Circuit #1 (utility circuit)
- BRTE8D2 / BRTE8DXW2 - Circuit #2 (utility circuit)
- BRTE8DA / BRTE8DXWA - Circuit A (dedicated circuit)
- BRTE8DB / BRTE8DXWB - Circuit B (dedicated circuit)

BWAECF	2.5 x 4.74 x 99.32	92.5	3.50	.30	\$429
--------	--------------------	------	------	-----	--------------

Ceiling pole brings ceiling feed conduit and data cables from the ceiling down to Power troughs height. Accommodates 10' ceiling heights. A two part construction allows power/data conduit lay-in. Includes mounting hardware and ceiling bezel. Ceiling feed harness sold separately.

BWAEECFH120	6 x 6 x 120	250	5	2	\$530
BWAEECFH144	6 x 6 x 144	250	6	3	\$588

Ceiling feed provides a single power entry from ceiling, through Ceiling pole into Power Trough, into Power Distribution Housing. An 8-wire (4-circuit) metal conduit harness with included metal junction box for hard wiring to the building power supply above ceiling tile. Must be hard wired to the building power supply by a licensed electrician. Ceiling feed post sold separately.

FTAETTC12	2.3 x 16 x 3	60	6	.12	\$409
FTAETTC18	2.3 x 22 x 3	60	8	.15	\$442
FTAETTC24	2.3 x 28 x 3	60	9	.18	\$466
FTAETTC30	2.3 x 34 x 3	60	10.60	.22	\$492
FTAETTC36	2.3 x 40 x 3	60	12	.24	\$516
FTAETTC42	2.3 x 46 x 3	60	11.60	.28	\$555
FTAETTC48	2.3 x 52 x 3	60	14	.30	\$591

Connects Freefit legs and trough provide to power data/communication pass thru. Connector kit consists of formed steel housing, mounting brackets, housing to housing harness (jumper) and one charcoal grey extruded data/communication cable manager. Knock out on top cover allows for ceiling post connection. Cover included. Specify paint finish.

- FTAETTC12 is used between two single sided or back to back stations that are 70" w (72" nominal) or less.
- FTAETTC18 is used between two single sided or back to back stations that are 76" w (78" nominal).
- FTAETTC24 is used between two single sided or back to back stations that are 82" w (84" nominal), or when separating two stations (up to 70" w) with a 12" w storage piece.
- FTAETTC30 is used to separate 2 workstations 70" w (72" nominal) or less with an 18" w storage unit in between the surfaces.
- FTAETTC36 is used between two single sided or back to back stations that are 70" w (72" nominal) or less with (2) 12" w storage units or (1) 24" w storage unit.
- FTAETTC42 is used between two single sided or back to back stations that are 70" w (72" nominal) or less with (2) 15" w storage units or (1) 30" w storage unit
- FTAETTC48 is used between two single sided or back to back stations that are 70" w (72" nominal) or less with (2) 18" w storage units or (1) 36" w storage unit.

Required specifications

Base finish*

ELECTRICAL COMPONENTS

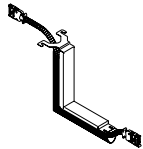
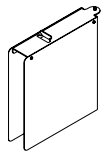

Table to Bridges Connector*



Leg Wire Manager*



Base Feed*

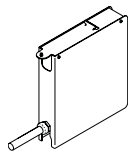

Base Feed* - New York Electrical

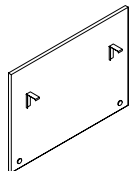

Back-to-Back End Gable*

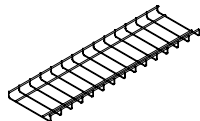

Under Worksurface Cable Basket

MODEL# DIMENSIONS FREIGHT CLASS WT./LBS. CUBIC FT. LIST PRICE

D x W x H

FTTABRC	14 x 2.3 x 15	100	2.40	.28	\$347
---------	---------------	-----	------	-----	--------------

Connects Freefit back-to-back benching to Bridges 29"H table with below worksurface power trough. Please specify paint finish on bracket. Wire manager is always Charcoal.

FTACCL	3.2 x 2 x 16	70	.06	.06	\$531
--------	--------------	----	-----	-----	--------------

Provides wire management from under FreeFit worksurface, down the leg and to the floor. Can only be used on FreeFit regular and media tables. Not for use on back-to-back tables. Kit includes wire manager housing, magnets, screws and cable chain. Magnetically fastens to the FreeFit leg and cable chain is screwed to worksurfaces. Please specify housing paint finish.

FTAEFF	8.75 x 2 x 10.8	92.5	3.50	.30	\$880
--------	-----------------	------	------	-----	--------------

Floor feed housing for FreeFit benching applications only. Includes liquitite whip , 72"L. Must be hard wired to the building power supply by a licensed electrician.

FTAEFF-NYC	14 x 2.55 x 13.41	92.5	3.50	.30	\$743
------------	-------------------	------	------	-----	--------------

Floor feed housing for FreeFit benching applications only. Includes liquitite whip , 72"L. Must be hard wired to the building power supply by a licensed electrician.

FTAEG18H	30.65 x .75 x 18	60	10	.24	\$479
FTAEG22H	30.65 x .75 x 22	60	13	.30	\$516

Optional back-to-back FreeFit Benching end gable is intended to be installed at the end of a FreeFit back-to-back table run. Made of 3/4" thermally fused laminate, it reduces the number of visible elements below the worksurface. Two heights are available. Specify FTAEG18H for extended range bases and FTAEG22H for standard range bases.

FFTCB36	8 x 8 x 1	70	.36	.03	\$121
FFTCB48	8 x 16 x 1	70	.73	.07	\$135
FFTCB54	8 x 22 x 1	70	1.01	.10	\$140
FFTCB60	8 x 28 x 1	70	1.20	.13	\$147
FFTCB66	8 x 34 x 1	70	1.56	.15	\$171
FFTCB72	8 x 40 x 1	70	1.80	.18	\$179
FFTCB78	8 x 46 x 1	92.5	2.16	.21	\$190
FFTCB84	8 x 52 x 1	100	2.39	.24	\$197

Shallow, 8" wide basket manages cable excess. It can be easily unclipped from steel brackets (included). Specify cable basket 30" shorter than worksurface. Steel wire construction, chrome finish baskets; black steel hanging brackets, fasteners.

Required specifications

Base finish*

ELECTRICAL COMPONENTS/ACCESSORIES



Cable Snake

MODEL#	DIMENSIONS D x W x H	FREIGHT CLASS	WT/LBS.	CUBIC FT.	LIST PRICE
BRACS	2 x 8 x 30	70	3	.19	\$153
BRACSH	2 x 8 x 49	70	3	.19	\$290

Flexible cable management trough. Two pathways within the snake, one for data/communication and one for routing power cables. Translucent White finish only.

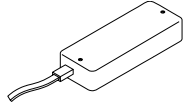

Battery and Charger

FTBATT	8 x 3 x 1.5	70	1.54	.02	\$466
--------	-------------	----	------	-----	--------------

Battery Pak with charging cable mounts to the underside of the worksurface. Features LED bars indicating capacity level and audio alarm when it needs to be charged. On a full charge, the table can cycle from 35 to 45 stroke lengths depending upon the range of column selected and load on the table.

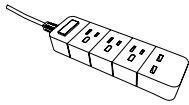

Power Bar with USB

BWAEGC00158GC	1 x 2.3 x 1.3	70	1	.50	\$146
---------------	---------------	----	---	-----	--------------

Power Bar with 3 receptacles + 2 USB and power switch. Standard with 6' cord. Rating 15A, 125V, AC 60Hz, 1875W. USB output 5V, 2.6A (max.) White case, white cord. Available to retrofit CTL/CTR or CTDHL/CTDHR.

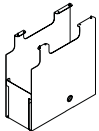

PC Holder

FTACPU	21 x 8 x 21	300	3.57	2.04	\$447
--------	-------------	-----	------	------	--------------

Accepts tower CPU's with a width range from 7.6" to 2.25"- and a maximum height of 18". Durable sheet metal construction. Please specify paint finish.

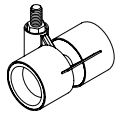

Dual Wheel Casters

BRTLCS	2.7 x 2.5 x 2.6	70	0.06	.01	\$35
--------	-----------------	----	------	-----	-------------

Locking caster. Interchangeable with glides on FreeFit bases. 40mm dia. caster with 8mm thread. White body, light grey tires.

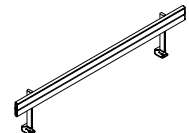

Single Table Accessory Rail*

BRLBST36	2.95 x 33 x 16	65	5.90	.26	\$417
BRLBST42	2.95 x 39 x 16	70	6.44	.30	\$439
BRLBST48	2.95 x 45 x 16	70	6.98	.35	\$455
BRLBST54	2.95 x 51 x 16	70	7.52	.39	\$472
BRLBST60	2.95 x 57 x 16	70	8.07	.43	\$482
BRLBST66	2.95 x 63 x 16	70	8.61	.48	\$499
BRLBST72	2.95 x 69 x 16	70	9.15	.52	\$516
BRLBST78	2.95 x 75 x 16	70	9.69	.56	\$532
BRLBST84	2.95 x 81 x 16	70	10.24	.61	\$548

Table mounted accessory rail. Compatible with standard Bins, Trays and Sorters. Includes end caps and mounting hardware. Please specify paint finish. To ensure proper connection and clearance on tables 46" wide and up, choose accessory rail 13" smaller than the actual table width (70" wide table gets 57" wide rail). Tables 40" wide and smaller use 33" wide accessory rail.

Required specifications

Base finish*

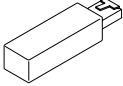
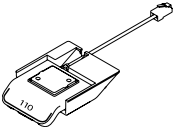
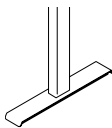
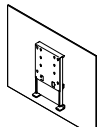
ACCESSORIES	MODEL#	DIMENSIONS	FREIGHT CLASS	WT/LBS.	CUBIC FT.	LIST PRICE
 <p>Anti-Collision Desk Sensor USB Plug</p>		D x W x H				
	FTACDS	8 x 3 x 1.5	60	1.54	.01	\$49
<p>Provides enhanced anti-collision detection. Plugs directly into leg column. Only one USB plug required for table assembly. This is a replacement part. One sensor ships standard with every table.</p>						
 <p>Reminder Controller - LED Display + Bluetooth</p>	FTDPG1C	3 x 4.3 x 1	70	0.4	.01	\$108
	<p>Up/down drive with 4 memory positions. LED light strip reminder, table height display. Bluetooth enabled, connects to Desk Control App. This is a replacement part. Every base comes standard with a controller.</p>					
 <p>Diode Reminder Controller - Memory + Bluetooth</p>	FTDPG1M	3 x 4.3 x 1	70	0.4	.01	\$44
	<p>Up/down drive with 2 memory positions. Bluetooth enabled, connects to Desk Control App. This is a replacement part. Every base comes standard with a controller.</p>					
 <p>Display Handset</p>	FTDHNBT	3 x 4.3 x 1	70	1	.01	\$110
	<p>Up/down drive with 3 memory positions and table height display. Must be specified separately from standard tables and replaced in the field. Use where Bluetooth capabilities are restricted.</p>					
 <p>T-Foot*</p>	FTFOOT24TL	23 x 3 x 1.16	60	4.4	.10	\$121
	FTFOOT30TL	29 x 3 x 1.16	60	4.85	.10	\$131
<p>Replacement single "T" foot or as an optional addition to a 3 leg table.</p>						
 <p>C-Foot*</p>	FTFOOT24CL	23 x 3 x 1.16	60	4.4	.10	\$133
	FTFOOT30CL	29 x 3 x 1.16	60	4.85	.10	\$144
<p>Replacement single "C" foot or as an optional addition to a 3 leg table.</p>						
 <p>Replacement Glides</p>	FTSETGLIDE	- x - x 1.5	70	.06	.10	\$9
	<p>Set of two with 1/2" adjustment.</p>					
 <p>TV Mount</p>	FTMT5145	4 x 51 x 40.5	250	16.82	4.8	\$915
	<p>TV mount for FreeFit media tables. Includes the TV/Display bracket and mounting hardware. Maximum TV size is 50".</p>					

Required specifications

Base finish*

PANTRY STORAGE - 42"H

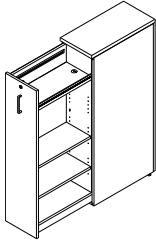

Left (NL) shown

Pantry Storage

MODEL#	DIMENSIONS D x W x H	FREIGHT CLASS	WT/LBS.	CUBIC FT.	LIST PRICE	HP ADD
FFPO1224H42NL	24 x 12 x 42	70	128	7	\$2318	\$29
FFPO1230H42NL	30 x 12 x 42	70	143	9	\$2435	\$35
FFPO1236H42NL	36 x 12 x 42	85	157	11	\$2551	\$40
FFPO1224H42NR	24 x 12 x 42	70	128	7	\$2318	\$29
FFPO1230H42NR	30 x 12 x 42	70	143	9	\$2435	\$35
FFPO1236H42NR	36 x 12 x 42	85	157	11	\$2551	\$40
FFPO1824H42NL	24 x 18 x 42	85	156	11	\$2668	\$40
FFPO1830H42NL	30 x 18 x 42	85	172	13	\$2796	\$51
FFPO1836H42NL	36 x 18 x 42	92.5	187	16	\$2923	\$62
FFPO1824H42NR	24 x 18 x 42	85	156	11	\$2668	\$40
FFPO1830H42NR	30 x 18 x 42	85	172	13	\$2796	\$51
FFPO1836H42NR	36 x 18 x 42	92.5	187	16	\$2923	\$62

The pull out cabinet serves as a multifunctional, customizable storage unit that both defines space and enhances privacy in an open plan environment. Internal organization consists of two fixed shelves on the top and bottom. The two middle shelves are adjustable. Two accessory rails (each 18.25" long) are standard and will accept metal accessories (sold separately - see previous page). Interior cabinet shelves and back are standard in Designer White. Cabinet shell, drawer and top can be specified in any standard laminate. FFPOxxxx will not allow binders.

- For Dry-erase marker board, specify **DE** and **add \$392**. If specified, the dry-erase marker laminate will be applied to the external surface of the pull-out drawer side wall.

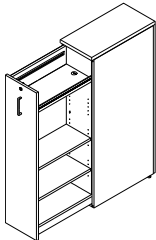

Left (NL) shown

Pantry Storage - w/USB

FFPO1224H42NLUSB	24 x 12 x 42	70	128	7	\$2892	\$29
FFPO1230H42NLUSB	30 x 12 x 42	70	143	9	\$3009	\$35
FFPO1236H42NLUSB	36 x 12 x 42	85	157	11	\$3126	\$40
FFPO1224H42NRUSB	24 x 12 x 42	70	128	7	\$2892	\$29
FFPO1230H42NRUSB	30 x 12 x 42	70	143	9	\$3009	\$35
FFPO1236H42NRUSB	36 x 12 x 42	85	157	11	\$3126	\$40
FFPO1824H42NLUSB	24 x 18 x 42	85	156	11	\$3242	\$40
FFPO1830H42NLUSB	30 x 18 x 42	85	172	13	\$3370	\$51
FFPO1836H42NLUSB	36 x 18 x 42	92.5	187	16	\$3497	\$62
FFPO1824H42NRUSB	24 x 18 x 42	85	156	11	\$3242	\$40
FFPO1830H42NRUSB	30 x 18 x 42	85	172	13	\$3370	\$51
FFPO1836H42NRUSB	36 x 18 x 42	92.5	187	16	\$3497	\$62

The pull out cabinet serves as a multifunctional, customizable storage unit that both defines space and enhances privacy in an open plan environment. Internal organization consists of two fixed shelves on the top and bottom. Top shelf comes with grey felt surface and grommet which allows for cable passage from the USB outlet (located below the top shelf). A 2-prong power cord exits the cabinet through the floor at the back. The two middle shelves are adjustable. Two accessory rails (each 18.25" long) are standard and will accept metal accessories (sold separately - see previous page). Interior cabinet shelves and back are standard in Designer White. Cabinet shell, drawer and top can be specified in any standard laminate. FFPOxxxx will not allow binders.

- For Dry-erase marker board, specify **DE** and **add \$392**. If specified, the dry-erase marker laminate will be applied to the external surface of the pull-out drawer side wall.

Required specifications

Laminate finish

Optional specifications

HP laminate
Dry-erase board

PANTRY STORAGE - 49.5"H

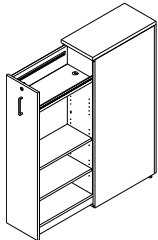

Left (NL) shown

Pantry Storage

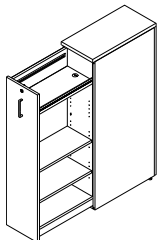

Left (NL) shown

Pantry Storage - w/USB

MODEL#	DIMENSIONS	FREIGHT CLASS	WT/LBS.	CUBIC FT.	LIST PRICE	HP ADD
D x W x H						
FFPO1224NL	24 x 12 x 49.5	70	133	8	\$2472	\$77
FFPO1230NL	30 x 12 x 49.5	85	148	10	\$2591	\$96
FFPO1236NL	36 x 12 x 49.5	92.5	162	15	\$2708	\$109
FFPO1224NR	24 x 12 x 49.5	70	133	8	\$2472	\$77
FFPO1230NR	30 x 12 x 49.5	85	148	10	\$2591	\$96
FFPO1236NR	36 x 12 x 49.5	92.5	162	15	\$2708	\$109
FFPO1824NL	24 x 18 x 49.5	85	161	12	\$2871	\$104
FFPO1830NL	30 x 18 x 49.5	92.5	177	15	\$2997	\$128
FFPO1836NL	36 x 18 x 49.5	92.5	192	18	\$3129	\$147
FFPO1824NR	24 x 18 x 49.5	85	161	12	\$2871	\$104
FFPO1830NR	30 x 18 x 49.5	92.5	177	15	\$2997	\$128
FFPO1836NR	36 x 18 x 49.5	92.5	192	18	\$3129	\$147

The pull out cabinet serves as a multifunctional, customizable storage unit that both defines space and enhances privacy in an open plan environment. Internal organization consists of two fixed shelves on the top and bottom. The two middle shelves are adjustable. Two accessory rails (each 18.25" long) are standard and will accept metal accessories (sold separately - see previous page). Interior cabinet shelves and back are standard in Designer White. Cabinet shell, drawer and top can be specified in any standard laminate. FFPOxxxx will not allow binders.

- For Dry-erase marker board, specify **DE** and **add \$392**. If specified, the dry-erase marker laminate will be applied to the external surface of the pull-out drawer side wall.

FFPO1224NLUSB	24 x 12 x 49.5	70	133	8	\$3046	\$77
FFPO1230NLUSB	30 x 12 x 49.5	85	148	10	\$3165	\$96
FFPO1236NLUSB	36 x 12 x 49.5	92.5	162	15	\$3284	\$109
FFPO1224NRUSB	24 x 12 x 49.5	70	133	8	\$3046	\$77
FFPO1230NRUSB	30 x 12 x 49.5	85	148	10	\$3165	\$96
FFPO1236NRUSB	36 x 12 x 49.5	92.5	162	15	\$3284	\$109
FFPO1824NLUSB	24 x 18 x 49.5	85	161	12	\$3442	\$104
FFPO1830NLUSB	30 x 18 x 49.5	92.5	177	15	\$3573	\$128
FFPO1836NLUSB	36 x 18 x 49.5	92.5	192	18	\$3705	\$147
FFPO1824NRUSB	24 x 18 x 49.5	85	161	12	\$3442	\$104
FFPO1830NRUSB	30 x 18 x 49.5	92.5	177	15	\$3573	\$128
FFPO1836NRUSB	36 x 18 x 49.5	92.5	192	18	\$3705	\$147

The pull out cabinet serves as a multifunctional, customizable storage unit that both defines space and enhances privacy in an open plan environment. Internal organization consists of two fixed shelves on the top and bottom. Top shelf comes with grey felt surface and grommet which allows for cable passage from the USB outlet (located below the top shelf). A 2-prong power cord exits the cabinet through the floor at the back. The two middle shelves are adjustable. Two accessory rails (each 18.25" long) are standard and will accept metal accessories (sold separately - see previous page). Interior cabinet shelves and back are standard in Designer White. Cabinet shell, drawer and top can be specified in any standard laminate. FFPOxxxx will not allow binders.

- For Dry-erase marker board, specify **DE** and **add \$392**. If specified, the dry-erase marker laminate will be applied to the external surface of the pull-out drawer side wall.

Required specifications

Laminate finish

Optional specifications

HP laminate
Dry-erase board

PANTRY STORAGE - 54"H

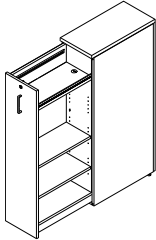

Left (NL) shown

Pantry Storage

MODEL#	DIMENSIONS D x W x H	FREIGHT CLASS	WT/LBS.	CUBIC FT.	LIST PRICE	HP ADD
FFPO1224H54NL	24 x 12 x 54	70	138	9	\$2551	\$29
FFPO1230H54NL	30 x 12 x 54	85	153	11	\$2673	\$29
FFPO1236H54NL	36 x 12 x 54	92.5	167	14	\$2796	\$40
FFPO1224H54NR	24 x 12 x 54	70	138	9	\$2551	\$29
FFPO1230H54NR	30 x 12 x 54	85	153	11	\$2673	\$29
FFPO1236H54NR	36 x 12 x 54	92.5	167	14	\$2796	\$40
FFPO1824H54NL	24 x 18 x 54	92.5	166	14	\$2956	\$40
FFPO1830H54NL	30 x 18 x 54	92.5	182	17	\$3090	\$51
FFPO1836H54NL	36 x 18 x 54	100	197	20	\$3223	\$57
FFPO1824H54NR	24 x 18 x 54	92.5	166	14	\$2956	\$40
FFPO1830H54NR	30 x 18 x 54	92.5	182	17	\$3090	\$51
FFPO1836H54NR	36 x 18 x 54	100	197	20	\$3223	\$57

The pull out cabinet serves as a multifunctional, customizable storage unit that both defines space and enhances privacy in an open plan environment. Internal organization consists of two fixed shelves on the top and bottom. The two middle shelves are adjustable. Two accessory rails (each 18.25" long) are standard and will accept metal accessories (sold separately - see previous page). Interior cabinet shelves and back are standard in Designer White. Cabinet shell, drawer and top can be specified in any standard laminate. FFPOxxxx will not allow binders.

- For Dry-erase marker board, specify **DE** and **add \$392**. If specified, the dry-erase marker laminate will be applied to the external surface of the pull-out drawer side wall.

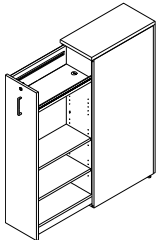

Left (NL) shown

Pantry Storage - w/USB

FFPO1224H54NLUSB	24 x 12 x 54	70	138	9	\$3126	\$29
FFPO1230H54NLUSB	30 x 12 x 54	85	153	11	\$3248	\$29
FFPO1236H54NLUSB	36 x 12 x 54	92.5	167	14	\$3370	\$40
FFPO1224H54NRUSB	24 x 12 x 54	70	138	9	\$3126	\$29
FFPO1230H54NRUSB	30 x 12 x 54	85	153	11	\$3248	\$29
FFPO1236H54NRUSB	36 x 12 x 54	92.5	167	14	\$3370	\$40
FFPO1824H54NLUSB	24 x 18 x 54	92.5	166	14	\$3530	\$40
FFPO1830H54NLUSB	30 x 18 x 54	92.5	182	17	\$3665	\$51
FFPO1836H54NLUSB	36 x 18 x 54	100	197	20	\$3798	\$57
FFPO1824H54NRUSB	24 x 18 x 54	92.5	166	14	\$3530	\$40
FFPO1830H54NRUSB	30 x 18 x 54	92.5	182	17	\$3665	\$51
FFPO1836H54NRUSB	36 x 18 x 54	100	197	20	\$3798	\$57

The pull out cabinet serves as a multifunctional, customizable storage unit that both defines space and enhances privacy in an open plan environment. Internal organization consists of two fixed shelves on the top and bottom. Top shelf comes with grey felt surface and grommet which allows for cable passage from the USB outlet (located below the top shelf). A 2-prong power cord exits the cabinet through the floor at the back. The two middle shelves are adjustable. Two accessory rails (each 18.25" long) are standard and will accept metal accessories (sold separately - see previous page). Interior cabinet shelves and back are standard in Designer White. Cabinet shell, drawer and top can be specified in any standard laminate. FFPOxxxx will not allow binders.

- For Dry-erase marker board, specify **DE** and **add \$392**. If specified, the dry-erase marker laminate will be applied to the external surface of the pull-out drawer side wall.

Required specifications

Laminate finish

Optional specifications

HP laminate
Dry-erase board

CUBE PEDESTALS

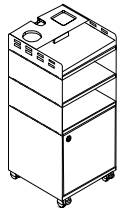

Left (BBFMKL) shown

Mobile Pedestal - BBF

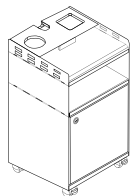

Left (BFMKL) shown

Mobile Pedestal - BF

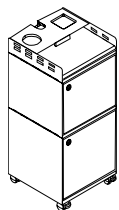

Left (SFMKL) shown

Mobile Pedestal - FF

MODEL# DIMENSIONS FREIGHT CLASS WT./LBS. CUBIC FT. LIST PRICE

D x W x H

Without lock:

FTSSP12BBFML	12 x 12 x 28	70	35	2.33	\$873
FTSSP12BBFMR	12 x 12 x 28	70	35	2.33	\$873

With Lock:

FTSSP12BBFMKL	12 x 12 x 28	70	35	2.33	\$951
FTSSP12BBFMKR	12 x 12 x 28	70	35	2.33	\$951

Mobile pedestal with two open boxes in the middle, one file box at the bottom and a top accessory tray. File box interior dimensions: 11-7/8"H x 11-13/16"W x 10-7/16"D. Includes four locking casters, metal wire divider and optional lock (must specify "K" before the left or right option). Metal wire divider is chrome and sits 3-7/16" from either side and is interchangeable. File door lock, if specified, is located on the top right corner for the right pedestal and top left corner for the left pedestal. Bottom, middle and top shelves, front door and back are made of 3/4" LP laminate. Sides are made of powder coated metal. Accessory tray is PET felt.

Without lock:

FTSSP12BFML	12 x 12 x 22	70	28	1.83	\$685
FTSSP12BFMR	12 x 12 x 22	70	28	1.83	\$685

With Lock:

FTSSP12BFMKL	12 x 12 x 22	70	28	1.83	\$762
FTSSP12BFMKR	12 x 12 x 22	70	28	1.83	\$762

Mobile pedestal with one open box in the middle, one file box at the bottom and a top accessory tray. File box interior dimensions: 11-7/8"H x 11-13/16"W x 10-7/16"D. Includes four locking casters, metal wire divider and optional lock (must specify "K" before the left or right option). Metal wire divider is chrome and sits 3-7/16" from either side and is interchangeable. File door lock, if specified, is located on the top right corner for the right pedestal and top left corner for the left pedestal. Bottom, middle and top shelves, front door and back are made of 3/4" LP laminate. Sides are made of powder coated metal. Accessory tray is PET felt.

Without lock:

FTSSP12SFML	12 x 12 x 28	70	35	2.33	\$796
FTSSP12SFMR	12 x 12 x 28	70	35	2.33	\$796

With Lock:

FTSSP12SFMKL	12 x 12 x 28	70	35	2.33	\$996
FTSSP12SFMKR	12 x 12 x 28	70	35	2.33	\$996

Mobile pedestal with one closed storage box at the top, one file box at the bottom and a top accessory tray. File box interior dimensions: 11-7/8"H x 11-13/16"W x 10-7/16"D. Closed storage box interior dimensions: 10-1/2"H x 11-13/16"W x 10-7/16"D. Includes four locking casters, metal wire divider and optional lock (must specify "K" before the left or right option). Metal wire divider is chrome and sits 3-7/16" from either side and is interchangeable. Door locks, if specified are located on the top right corner for the right pedestal and top left corner for the left pedestal of each box. Bottom, middle and top shelves, front door and back are made of 3/4" LP laminate. Sides are made of powder coated metal. Accessory tray is PET felt.

Required specifications

- Metal finish
- Laminate finish

HANGING PEDESTALS

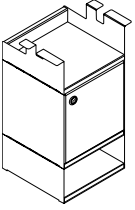

Left (BFBKL) shown

Hanging Pedestal - BFB

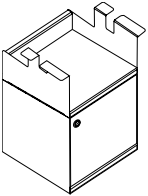

Left (BFKL) shown

Hanging Pedestal - FB

MODEL# DIMENSIONS FREIGHT CLASS WT/LBS. CUBIC FT. LIST PRICE

D x W x H

Without lock:

FTSSPH12BFBKL	12 x 12 x 24	92.5	26	2.33	\$679
FTSSPH12BFBRR	12 x 12 x 24	92.5	26	2.33	\$679

With Lock:

FTSSPH12BFBKL	12 x 12 x 24	92.5	26	2.33	\$755
FTSSPH12BFBKR	12 x 12 x 24	92.5	26	2.33	\$755

Hanging pedestal with one file box in the middle and two open boxes, one at the top and one at the bottom. Attaches to the underside of a worksurface with supplied screws. File box interior dimensions: 11-7/8"H x 11-13/16"W x 10-7/16"D. Includes metal wire divider and optional lock (must specify "K" before the left or right option). Metal wire divider is chrome and sits 3-7/16" from either side and is interchangeable. File door lock, if specified, is located on the top right corner for the right pedestal and top left corner for the left pedestal. Bottom, middle and top shelves, front door and back are made of 3/4" LP laminate. Sides are made of powder coated metal.

Without lock:

FTSSPH12BFL	12 x 12 x 18.5	92.5	20	1.83	\$490
FTSSPH12BFR	12 x 12 x 18.5	92.5	20	1.83	\$490

With Lock:

FTSSPH12BFL	12 x 12 x 18.5	92.5	20	1.83	\$568
FTSSPH12BFR	12 x 12 x 18.5	92.5	20	1.83	\$568

Hanging pedestal with one file box at the bottom and one open box at the top. Attaches to the underside of a worksurface with supplied screws. File box interior dimensions: 11-7/8"H x 11-13/16"W x 10-7/16"D. Includes metal wire divider and optional lock (must specify "K" before the left or right option). Metal wire divider is chrome and sits 3-7/16" from either side and is interchangeable. File door lock, if specified, is located on the top right corner for the right pedestal and top left corner for the left pedestal. Bottom, middle and top shelves, front door and back are made of 3/4" LP laminate. Sides are made of powder coated metal.

Required specifications

- Metal finish
- Laminate finish

HANGING PEDESTALS

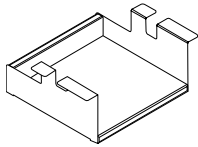

Hanging Pedestal Box*

MODEL#	DIMENSIONS D x W x H	FREIGHT CLASS	WT./LBS.	CUBIC FT.	LIST PRICE
FTSSPH12B	12 x 12 x 6	125	6	0.96	\$190

Hanging pedestal open box. Attaches to the underside of a worksurface with supplied screws to create an open box. Bottom, middle and top shelves, front door and back are made of 3/4" LP laminate. Sides are made of powder coated metal.

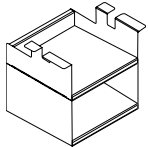

Hanging Pedestal - Two Open Boxes*

FTSSPH12BB	12 x 12 x 6	100	12	1.42	\$379
------------	-------------	-----	----	------	--------------

Hanging pedestal with two open boxes. Attaches to the underside of a worksurface with supplied screws. Bottom, middle and top shelves, front door and back are made of 3/4" LP laminate. Sides are made of powder coated metal.

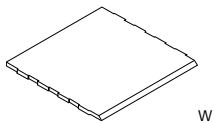

Felt Shelf Liner

FTFELT03BC	12 x 12 x 6	70	0.01	0.03	\$36
------------	-------------	----	------	------	-------------

Felt shelf liner can be added to any closed back shelf. Front edge is cut at 45°.

Required specifications

- Metal finish*
- Laminate finish*

BACK-TO-BACK TABLE - 21"H DIVIDERS

D x W x H

- FreeFit table mounted dividers for single table or single table row; recessed 6.5" at both ends (for example - 72" (70" actual) FreeFit table mounted divider measures 57").
- The center of all dividers is always mounted 2.250" from worksurface's rear edge. Please note the gap between the divider and the worksurface therefore varies, depending on the divider thickness (1.250" framed dividers, 0.750" frameless LP and 0.250" frameless glass).
- 48" (33" actual) - 66" (51" actual) dividers have 2 mounting brackets.
- 72" (57" actual) dividers have 3 mounting brackets.

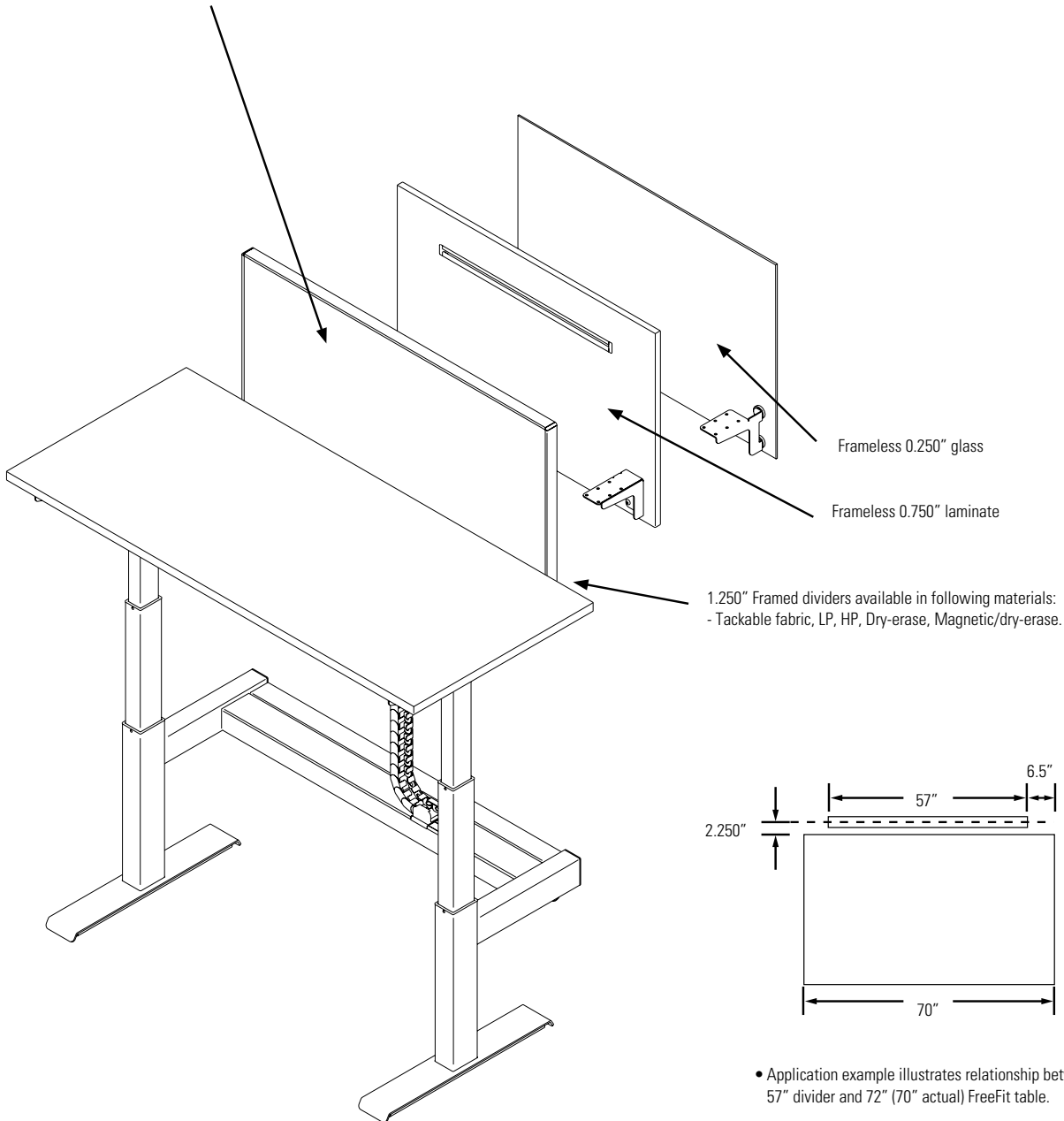

- Application example illustrates relationship between 57" divider and 72" (70" actual) FreeFit table.

- Example Order:
 BWATMFD72
 (actual dimension of 57") for
 BWA2D3072A8
 (actual dimension of 70").

BACK-TO-BACK TABLE - 37"H DIVIDERS

FreeFit Back-to-Back stationary dividers; stationary, shared, secured to table structure; recessed 6.5" at both ends (for example - 72" (70" actual) FreeFit table mounted divider measures 57").

The center of all dividers is always mounted 2.250" from worksurface's rear edge. Please note the gap between the divider and the worksurface therefore varies, depending on the divider thickness (1.250" Framed dividers, 0.750" frameless LP and 0.250" frameless glass).

48" (33" actual) divider for 48" (46" actual) table
 54" (39" actual) divider for 54" (52" actual) table
 60" (45" actual) divider for 60" (58" actual) table
 66" (51" actual) divider for 66" (64" actual) table
 72" (57" actual) divider for 72" (70" actual) table

Framed dividers (Tackable fabric, LP, HP, Dryerase, Magnetic/dry-erase)
 Frameless LP
 Frameless glass

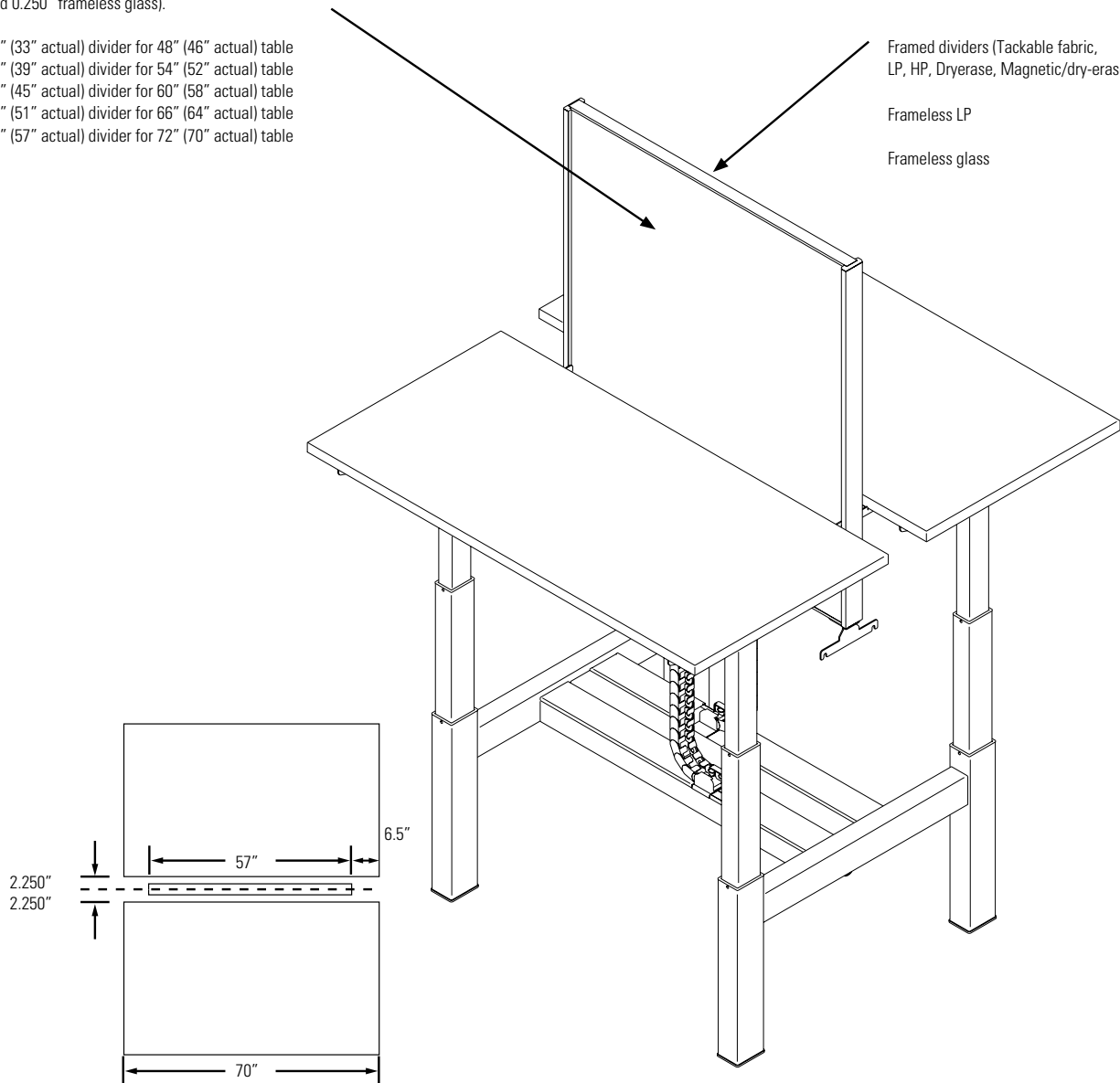

Application example illustrates relationship between 57" shared divider and 72" (70" actual) FreeFit Back-to-Back table.

- Example Order:
 BWASFD72
 (actual dimension of 57") for
 BWA2D6072A8
 (actual dimension of 70").

FELT DIVIDERS

- 9mm thick panels offered in 9 finishes
- Made from 100% PET (polyester) fiber with a high content (50%) of post-recycled material, free of added chemicals, binders and adhesives
- Lightweight panels are tackable, impact and tear resistant, bacteria resistant, moisture resistant, and installation friendly
- Variation in fiber mix and color are inherent to the character of the product

FELT COLORS

BLK	Black	MTS	Mist
BRI	Brick	PWT	Pewter
DEN	Denim	SHR	Shamrock
GPH	Graphite	WHT	White
HVT	Harvest		

BRACKET FINISH

BLK	Black	NEV	Nevada
CHR	Charcoal	SIL	Silver
DWT	Designer White	TPE	Taupe
FOG	Fog	TUN	Tungsten

FELT DIVIDERS

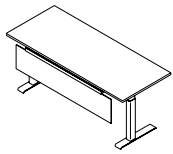

Modesty Felt Divider

FELT DIVIDERS

MODEL#	DIMENSIONS	FREIGHT CLASS	WT/LBS.	CUBIC FT.	LIST PRICE
BWAFMPSN36	4.17 x 21 x 13.94	70	1.84	0.71	\$187
BWAFMPSN42	4.17 x 27 x 13.94	250	2.32	0.91	\$204
BWAFMPSN48	4.17 x 33 x 13.94	250	2.44	1.11	\$284
BWAFMPSN54	4.17 x 39 x 13.94	250	2.86	1.31	\$319
BWAFMPSN60	4.17 x 45 x 13.94	250	3.27	1.51	\$360
BWAFMPSN66	4.17 x 51 x 13.94	250	3.68	1.72	\$508
BWAFMPSN72	4.17 x 57 x 13.94	250	4.09	1.92	\$541

9mm thick PET felt divider is tackable. Fastens to the underside of the worksurface. Installed divider measures 15" below top of the worksurface. Kit includes felt modesty, support extrusion and left and right brackets. Available in 9 PET felt colors. Please specify.

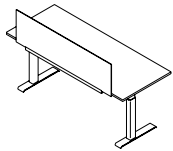

Parallel Felt Divider

BWAFPN36	5.86 x 21 x 18.24	300	2.21	1.3	\$199
BWAFPN42	5.86 x 27 x 18.24	300	2.77	1.67	\$224
BWAFPN48	5.86 x 33 x 18.24	300	2.82	2.04	\$304
BWAFPN54	5.86 x 39 x 18.24	300	3.29	2.41	\$340
BWAFPN60	5.86 x 45 x 18.24	300	3.75	2.78	\$387
BWAFPN66	5.86 x 51 x 18.24	300	4.22	3.15	\$543
BWAFPN72	5.86 x 57 x 18.24	300	4.69	3.53	\$579

Connects parallel on Freefit tables. 9mm thick PET felt divider is tackable. Installed divider measures 15.7" high from the top of the worksurface. Kit includes felt divider, support extrusion and left and right brackets. Available in 9 PET felt colors. Please specify.

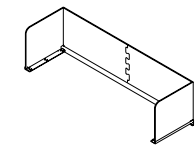

Single

BWAFWR2346	18.46 x 46.84 x 18.24	65	26.58	1.07	\$586
BWAFWR2352	18.46 x 52.84 x 18.24	65	28.4	1.21	\$620
BWAFWR2358	18.46 x 58.84 x 18.24	65	30.22	1.34	\$653
BWAFWR2364	18.46 x 64.84 x 18.24	60	32.02	0.74	\$863
BWAFWR2370	18.46 x 70.84 x 18.24	60	33.84	0.81	\$920
BWAFWR2946	24.46 x 46.84 x 18.24	65	30.74	1.07	\$663
BWAFWR2952	24.46 x 52.84 x 18.24	60	32.55	0.6	\$872
BWAFWR2958	24.46 x 58.84 x 18.24	60	34.37	0.67	\$930
BWAFWR2964	24.46 x 64.84 x 18.24	60	36.19	0.74	\$987
BWAFWR2970	24.46 x 70.84 x 18.24	60	38	0.81	\$1045

End of Run:

BWAFWR2351	18.46 x 51.34 x 18.24	65	27.94	1.05	\$591
BWAFWR2951	24.46 x 51.34 x 18.24	60	32.09	0.62	\$871
BWAFWR2363	18.46 x 63.34 x 18.24	70	31.57	1.5	\$860
BWAFWR2963	24.46 x 63.34 x 18.24	60	35.73	0.87	\$984

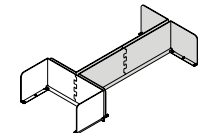

End of Run

Felt Wrap Around Divider*

Wraps around Freefit tables to provide privacy. 9mm thick PET felt divider is tackable. Fastens to the underside of the worksurface. Installed divider measures 15.7" from the top of the worksurface. Divider extends 1.5" past the back of the worksurface. Please choose standard base finish for the extrusion and brackets. PET is available in 9 felt colors. Please specify.

- Anodized Aluminum extrusion - Add **\$156** list upcharge

Required Specifications

Felt color
Bracket finish

Optional Specifications

Anodized extrusion

FELT DIVIDERS

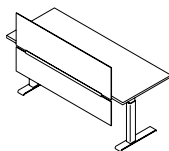

Felt Parallel Divider

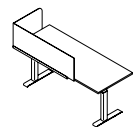

Corner Wrap Felt Divider

MODEL# DIMENSIONS FREIGHT CLASS WT/LBS. CUBIC FT. LIST PRICE

D x W x H

BWAFPDN36	5.86 x 21 x 30.68	300	2.79	2.18	\$294
BWAFPDN42	5.86 x 27 x 30.68	300	3.56	2.81	\$321
BWAFPDN48	5.86 x 33 x 30.68	150	3.82	3.43	\$456
BWAFPDN54	5.86 x 39 x 30.68	150	4.5	4.06	\$505
BWAFPDN60	5.86 x 45 x 30.68	150	5.17	4.68	\$589
BWAFPDN66	5.86 x 51 x 30.68	150	5.85	5.31	\$902
BWAFPDN72	5.86 x 57 x 30.68	150	6.53	5.93	\$957

Felt divider and modesty panel kit secures to the rear bottom of a regular FreeFit table and provides privacy above and below the worksurface. 9mm thick PET felt divider is tackable. Installed divider measures 15.7" from the top of the worksurface and 15" below the top of the worksurface. Kit includes two felt dividers, support extrusion and left and right brackets. Available in 9 PET felt colors. Please specify.

BW AFC2432L	18.52 x 32.46 x 18.24	150	3.82	6.35	\$414
BW AFC2432R	18.52 x 32.46 x 18.24	150	3.82	6.35	\$414
BW AFC2438L	18.52 x 38.46 x 18.24	250	5.46	7.52	\$472
BW AFC2438R	18.52 x 38.46 x 18.24	250	5.46	7.52	\$472
BW AFC2448L	18.52 x 47.46 x 18.24	250	6.16	9.28	\$508
BW AFC2448R	18.52 x 47.46 x 18.24	250	6.16	9.28	\$508

BW AFC3032L	24.52 x 32.46 x 18.24	250	5.72	8.40	\$467
BW AFC3032R	24.52 x 32.46 x 18.24	250	5.72	8.40	\$467
BW AFC3038L	24.52 x 38.46 x 18.24	250	6.19	9.95	\$501
BW AFC3038R	24.52 x 38.46 x 18.24	250	6.19	9.95	\$501
BW AFC3048L	24.52 x 47.46 x 18.24	250	6.89	12.28	\$538
BW AFC3048R	24.52 x 47.46 x 18.24	250	6.89	12.28	\$538

Felt Corner Wrap secures to the side and rear bottom of a FreeFit table, wraps around one side and provides limited privacy. 9mm thick PET felt divider is tackable. Installed divider measures 15.7" from the top of the worksurface. Kit includes felt dividers, support extrusion and large and small brackets. Available in 9 PET felt colors. Please specify.

Required Specifications

- Felt color
- Bracket finish

TABLE MOUNTED DIVIDERS

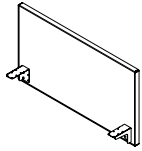

Table Mounted Framed Divider, Fabric*

MODEL#	DIMENSIONS D x W x H	FREIGHT CLASS	WT/LBS.	CUBIC FT.	LIST PRICE
BWATMFD48	1.25 x 33 x 21.5	85	16	1.23	\$431
BWATMFD54	1.25 x 39 x 21.5	85	18	1.46	\$532
BWATMFD60	1.25 x 45 x 21.5	85	20	1.68	\$581
BWATMFD66	1.25 x 51 x 21.5	85	22	1.90	\$652
BWATMFD72	1.25 x 57 x 21.5	85	26	2.13	\$712

Connects parallel on Freefit single and back-to-back tables. Fabric divider is tackable. Fastens to the underside of the worksurface. 1.625" gap between worksurface and divider allows for cable pass-through. Installed divider measures 15.7" from top of worksurface and 5.75" below the worksurface. 48" to 66" dividers include 2 support brackets. 72" divider includes 3 support brackets. Available in the following textiles:

- Global: **Anchorage, Lola, and Merge.**

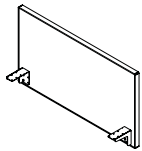

Table Mounted Framed Divider, Laminate**

MODEL#	DIMENSIONS D x W x H	FREIGHT CLASS	WT/LBS.	CUBIC FT.	LIST PRICE	HP ADD	DE ADD	DM ADD
BWATMLD48	1.25 x 33 x 21.5	85	35	1.23	\$283	\$165	\$340	\$519
BWATMLD54	1.25 x 39 x 21.5	85	39	1.46	\$319	\$213	\$424	\$655
BWATMLD60	1.25 x 45 x 21.5	85	44	1.68	\$379	\$225	\$446	\$697
BWATMLD66	1.25 x 51 x 21.5	85	48	1.90	\$436	\$308	\$932	\$1382
BWATMLD72	1.25 x 57 x 21.5	85	52	2.13	\$475	\$311	\$926	\$1373

Connects parallel on Freefit single and back-to-back tables. Divider infill can be specified in low pressure laminate (**LP**), high pressure laminate (**HP**), dry erase whiteboard (**DE**) or dry erase magnetic whiteboard (**DM**) user side only. Fastens to the underside of the worksurface. 1.625" gap between worksurface and divider allows for cable pass-through. Installed divider measures 15.7" from top of worksurface and 5.75" below the worksurface. 48" to 66" dividers include 2 support brackets. 72" divider includes 3 support brackets. When dry erase magnetic whiteboard (DM) is specified it is applied user side ONLY and dry erase whiteboard (DE) is applied on the opposite side.

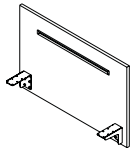

Table Mounted Laminate Divider**

BWATMLLD48	.75 x 33 x 21.5	125	16	1.23	\$339
BWATMLLD54	.75 x 39 x 21.5	125	18	1.46	\$359
BWATMLLD60	.75 x 45 x 21.5	125	20	1.68	\$380
BWATMLLD66	.75 x 51 x 21.5	125	22	1.90	\$561
BWATMLLD72	.75 x 57 x 21.5	125	26	2.13	\$580

Connects parallel on Freefit single and back-to-back tables. Laminate divider with integrated accessory rail, installed on one side only. Integrated anodized aluminum accessory rail, white cut out and rail trims; white power coat brackets. 3/4" LP PVC edged boards. Specify laminate and PVC edge. Fastens to the underside of the worksurface. 1.88" gap between worksurface and divider allows for cable pass-through. Installed divider measures 15.7" from top of worksurface and 5.75" below the worksurface. 48" to 66" dividers include 2 support brackets. 72" divider includes 3 support brackets.

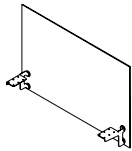

Table Mounted Glass Divider

BWATMGD48	.25 x 33 x 21.5	125	16	1.23	\$724
BWATMGD54	.25 x 39 x 21.5	125	19	1.46	\$779
BWATMGD60	.25 x 45 x 21.5	125	22	1.68	\$834
BWATMGD66	.25 x 51 x 21.5	125	24	1.90	\$884
BWATMGD72	.25 x 57 x 21.5	125	28	2.13	\$942

Frameless glass divider connects parallel on Freefit single and back-to-back tables. Tempered glass, acid etched on one side (similar to frosted), satin chrome disc fasteners and white powder coated steel support brackets. Fastens to the underside of the worksurface. 2.13" gap between worksurface and divider allows for cable pass-through. Installed divider measures 15.7" from top of worksurface and 4.75" below the worksurface. 48" to 66" dividers include 2 support brackets. 72" divider includes 3 support brackets. 1/2" radius on all four corners.

Required specifications

- Fabric*
- Laminate finish**
- Metal frame finish

STATIONARY DIVIDERS

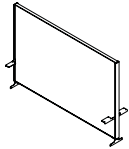

Stationary Framed Divider, Fabric*

MODEL#	DIMENSIONS D x W x H	FREIGHT CLASS	WT/LBS.	CUBIC FT.	LIST PRICE
BWASFD48	1.25 x 33 x 37.2	92.5	25	2.13	\$941
BWASFD54	1.25 x 39 x 37.2	92.5	28	2.52	\$959
BWASFD60	1.25 x 45 x 37.2	92.5	31	2.91	\$990
BWASFD66	1.25 x 51 x 37.2	92.5	34	3.29	\$1052
BWASFD72	1.25 x 57 x 37.2	92.5	37	3.68	\$1344

Provides a stationary framed divider between back-to-back height adjustable tables. Fabric divider is tackable. Divider is anchored to the base and captured between two aluminum upright tracks. The uprights have sliding brackets that connect the worksurfaces to the divider providing continuous support as it travels up and down. 1.625" gap between worksurface and divider allows for cable pass-through. Installed divider measures 54" from floor. Available in the following textiles:

- Global: **Anchorage, Lola, and Merge**

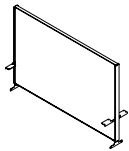

Stationary Framed Divider, Laminate**

MODEL#	DIMENSIONS D x W x H	FREIGHT CLASS	WT/LBS.	CUBIC FT.	LIST PRICE	HP ADD	DE ADD	DM ADD
BWASLD48	2 x 33 x 37.2	65	58	2.13	\$1194	\$405	\$849	\$2224
BWASLD54	2 x 39 x 37.2	65	66	2.52	\$1287	\$434	\$893	\$2338
BWASLD60	2 x 45 x 37.2	65	73	2.91	\$1308	\$435	\$893	\$2339
BWASLD66	2 x 51 x 37.2	65	81	3.29	\$1407	\$486	\$1951	\$4694
BWASLD72	2 x 57 x 37.2	65	88	3.68	\$1923	\$724	\$1875	\$5003

Provides a stationary framed divider between back-to-back height adjustable tables. Divider infill can be specified in low pressure laminate (**LP**), high pressure laminate (**HP**), dry erase whiteboard (**DE**) or dry erase magnetic whiteboard (**DM**) user side only. Divider is anchored to the base and captured between two aluminum upright tracks. The uprights have sliding brackets that connect the worksurfaces to the divider providing continuous support as it travels up and down. 1.625" gap between worksurface and divider allows for cable pass-through. Installed divider measures 54" from floor.

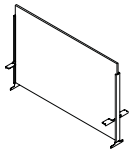

Stationary Laminate Divider**

BWASLLD48	2 x 33 x 37.2	85	28	2.13	\$685
BWASLLD54	2 x 39 x 37.2	85	33	2.52	\$706
BWASLLD60	2 x 45 x 37.2	85	37	2.91	\$725
BWASLLD66	2 x 51 x 37.2	85	41	3.29	\$1098
BWASLLD72	2 x 57 x 37.2	85	46	3.68	\$1120

Provides a stationary laminate divider between back-to-back height adjustable tables. Divider is anchored to the base and captured between two aluminum upright tracks. The uprights have sliding brackets that connect the worksurfaces to the divider providing continuous support as it travels up and down. 1.88" gap between worksurface and divider allows for cable pass-through. Installed divider measures 54" from floor.

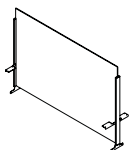

Stationary Glass Divider

BWASGD48	2 x 33 x 37.2	85	30	2.13	\$642
BWASGD54	2 x 39 x 37.2	85	34	2.52	\$730
BWASGD60	2 x 45 x 37.2	85	39	2.91	\$828
BWASGD66	2 x 51 x 37.2	85	43	3.29	\$918
BWASGD72	2 x 57 x 37.2	85	48	3.68	\$1006

Provides a stationary glass divider between back-to-back height adjustable tables. Tempered glass, acid etched on one side (similar to frosted), satin chrome disc fasteners and white powder coated steel support brackets. Divider is anchored to the base and captured between two aluminum upright tracks. The uprights have sliding brackets that connect the worksurfaces to the divider providing continuous support as it travels up and down. 2.13" gap between worksurface and divider allows for cable pass-through. 1/2" radius on top two corners.

Required specifications

- Fabric*
- Laminate finish**
- Metal frame finish

WELLNESS SCREENS- POLYCARBONATE

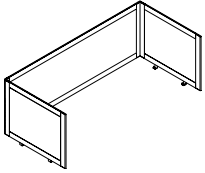

24" H Polycarbonate Divider Screen

MODEL#	DIMENSIONS D x W x H	FREIGHT CLASS	WT./LBS.	CUBIC FT.	LIST PRICE
FFTDP2436H24	31.75 x 34 x 24.6	125	26.55	3.94	\$1126
FFTDP2442H24	31.75 x 40 x 24.6	125	28.10	4.59	\$1162
FFTDP2448H24	31.75 x 46 x 24.6	150	29.65	5.25	\$1194
FFTDP2454H24	31.75 x 52 x 24.6	150	31.20	5.94	\$1229
FFTDP2460H24	31.75 x 58 x 24.6	150	32.75	6.56	\$1263
FFTDP2466H24	31.75 x 64 x 24.6	150	34.30	7.22	\$1295
FFTDP2472H24	31.75 x 70 x 24.6	150	35.85	7.88	\$1331
FFTDP2478H24	31.75 x 76 x 24.6	150	37.40	8.53	\$1366
FFTDP2484H24	31.75 x 82 x 24.6	150	38.95	9.19	\$1399
FFTDP3036H24	37.75 x 34 x 24.6	100	40.50	4.72	\$1205
FFTDP3042H24	37.75 x 40 x 24.6	125	42.05	5.51	\$1241
FFTDP3048H24	37.75 x 46 x 24.6	125	43.60	6.29	\$1275
FFTDP3054H24	37.75 x 52 x 24.6	125	45.15	7.08	\$1312
FFTDP3060H24	37.75 x 58 x 24.6	150	46.70	7.85	\$1344
FFTDP3066H24	37.75 x 64 x 24.6	150	48.25	8.65	\$1377
FFTDP3072H24	37.75 x 70 x 24.6	150	49.80	9.44	\$1412
FFTDP3078H24	37.75 x 76 x 24.6	150	51.35	10.22	\$1446
FFTDP3084H24	37.75 x 82 x 24.6	150	52.90	11.01	\$1481

Powder coated aluminum frame, translucent ribbed polycarbonate. Includes all hardware to connect. Brackets are painted steel. Side dividers extend 7.25" from the front edge of each surface. Back divider extends over the back edge of the worksurface by 1.5", allowing for cable pass-through to trough. Width and depth are nominal sizes representing the sizes of the FreeFit table. Allow for .25" overhang at the sides, 1.5" at the back, and 7.25" at the front. Frame and hardware available in Black (BLK), Charcoal (CHR), Designer White (DWT), Fog (FOG), Nevada (NEV), Silver (SIL), Taupe (TPE), Tungsten (TUN).

- FFTDP24xxH24 are for configurations with 23" deep surfaces.
- FFTDP30xxH24 are for configurations with 29" deep surfaces.

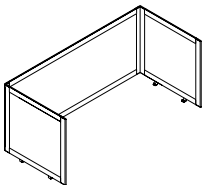

30" H Polycarbonate Divider Screen

FFTDP2436H30	31.75 x 34 x 30.6	125	26.55	3.94	\$1263
FFTDP2442H30	31.75 x 40 x 30.6	125	28.10	4.59	\$1304
FFTDP2448H30	31.75 x 46 x 30.6	150	29.65	5.25	\$1344
FFTDP2454H30	31.75 x 52 x 30.6	150	31.20	5.91	\$1382
FFTDP2460H30	31.75 x 58 x 30.6	150	32.75	6.56	\$1422
FFTDP2466H30	31.75 x 64 x 30.6	150	34.30	7.22	\$1460
FFTDP2472H30	31.75 x 70 x 30.6	150	35.85	7.88	\$1500
FFTDP2478H30	31.75 x 76 x 30.6	150	37.40	8.53	\$1538
FFTDP2484H30	31.75 x 82 x 30.6	150	38.95	9.19	\$1578
FFTDP3036H30	37.75 x 34 x 30.6	100	40.50	4.72	\$1340
FFTDP3042H30	37.75 x 40 x 30.6	125	42.05	5.51	\$1382
FFTDP3048H30	37.75 x 46 x 30.6	125	43.60	6.29	\$1421
FFTDP3054H30	37.75 x 52 x 30.6	125	45.15	7.08	\$1457
FFTDP3060H30	37.75 x 58 x 30.6	150	46.70	7.87	\$1496
FFTDP3066H30	37.75 x 64 x 30.6	150	48.25	8.65	\$1537
FFTDP3072H30	37.75 x 70 x 30.6	150	49.80	9.44	\$1573
FFTDP3078H30	37.75 x 76 x 30.6	150	51.35	10.22	\$1615
FFTDP3084H30	37.75 x 82 x 30.6	150	52.90	11.01	\$1655

Powder coated aluminum frame, translucent ribbed polycarbonate. Includes all hardware to connect. Brackets are painted steel. Side dividers extend 7.25" from the front edge of each surface. Back divider extends over the back edge of the worksurface by 1.5", allowing for cable pass-through to trough. Width and depth are nominal sizes representing the sizes of the FreeFit table. Allow for .25" overhang at the sides, 1.5" at the back, and 7.25" at the front. Frame and hardware available in Black (BLK), Charcoal (CHR), Designer White (DWT), Fog (FOG), Nevada (NEV), Silver (SIL), Taupe (TPE), Tungsten (TUN).

- FFTDP24xxH30 are for configurations with 23" deep surfaces.
- FFTDP30xxH30 are for configurations with 29" deep surfaces.

Required specifications
Frame finish

WELLNESS SCREENS - GLASS

MODEL# DIMENSIONS FREIGHT CLASS WT/LBS. CUBIC FT. LIST PRICE FRST ADD

D x W x H

FFTDG2436H24	31.50 x 36 x 24.60	125	26.55	3.94	\$1569	\$318
FFTDG2442H24	31.50 x 42 x 24.60	125	28.10	4.59	\$1621	\$325
FFTDG2448H24	31.50 x 48 x 24.60	150	29.65	5.25	\$1674	\$338
FFTDG2454H24	31.50 x 54 x 24.60	150	31.20	5.91	\$1724	\$350
FFTDG2460H24	31.50 x 60 x 24.60	150	32.75	6.56	\$1782	\$358
FFTDG2466H24	31.50 x 66 x 24.60	150	34.30	7.22	\$1829	\$371
FFTDG2472H24	31.50 x 72 x 24.60	150	35.85	7.88	\$1894	\$383
FFTDG2478H24	31.50 x 78 x 24.60	150	37.40	8.53	\$1932	\$391
FFTDG2484H24	31.50 x 84 x 24.60	150	38.95	9.19	\$1983	\$403
FFTDG3036H24	37.75 x 36 x 24.60	100	40.50	4.72	\$1674	\$338
FFTDG3042H24	37.75 x 42 x 24.60	125	42.05	5.51	\$1719	\$345
FFTDG3048H24	37.75 x 48 x 24.60	125	43.60	6.29	\$1770	\$358
FFTDG3054H24	37.75 x 54 x 24.60	150	45.15	7.08	\$1822	\$371
FFTDG3060H24	37.75 x 60 x 24.60	150	46.70	7.87	\$1874	\$378
FFTDG3066H24	37.75 x 66 x 24.60	150	48.25	8.65	\$1932	\$391
FFTDG3072H24	37.75 x 72 x 24.60	150	49.80	9.44	\$1977	\$396
FFTDG3078H24	37.75 x 78 x 24.60	150	51.35	10.22	\$2029	\$409
FFTDG3084H24	37.75 x 84 x 24.60	150	52.90	11.01	\$2082	\$423

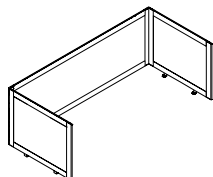

24" H Single Table Glass Divider Screen

Provides privacy in an open plan environment. Easy to clean table mounted partitions. Powder coated aluminum frame with 4mm clear (CLR) glass. Includes all hardware to connect. Brackets are painted steel. Side dividers extend 6.237" from the front edge of each surface. Back divider extends over the back edge of the worksurface by 1.5", allowing for cable pass-through to trough. Width and depth are nominal sizes representing the sizes of the FreeFit table. Allow for .25" overhang at the sides, 1.5" at the back, and 6.237" at the front. Frame and hardware available in Black (BLK), Charcoal (CHR), Designer White (DWT), Fog (FOG), Nevada (NEV), Silver (SIL), Taupe (TPE), Tungsten (TUN). End trim cap is only available in Charcoal (CHR). **Add 20%** upcharge for frosted glass (FRST).

- **FFTDG24xxH24 are for configurations with 24" deep surfaces.**
- **FFTDG30xxH24 are for configurations with 30" deep surfaces.**

FFTDG2436H30	31.50 x 36 x 30.60	125	28.85	3.97	\$1647	\$333
FFTDG2442H30	31.50 x 42 x 30.60	125	30.40	4.59	\$1699	\$345
FFTDG2448H30	31.50 x 48 x 30.60	125	31.95	5.25	\$1749	\$350
FFTDG2454H30	31.50 x 54 x 30.60	150	33.50	5.91	\$1808	\$365
FFTDG2460H30	31.50 x 60 x 30.60	150	35.05	6.56	\$1861	\$378
FFTDG2466H30	31.50 x 66 x 30.60	150	36.60	7.22	\$1907	\$383
FFTDG2472H30	31.50 x 72 x 30.60	150	38.15	7.88	\$1945	\$391
FFTDG2478H30	31.50 x 78 x 30.60	150	39.70	8.53	\$2016	\$409
FFTDG2484H30	31.50 x 84 x 30.60	150	41.25	9.19	\$2074	\$416
FFTDG3036H30	37.75 x 36 x 30.60	100	42.80	4.72	\$1749	\$350
FFTDG3042H30	37.75 x 42 x 30.60	100	44.35	5.51	\$1808	\$365
FFTDG3048H30	37.75 x 48 x 30.60	125	45.90	6.29	\$1854	\$378
FFTDG3054H30	37.75 x 54 x 30.60	125	47.45	7.08	\$1907	\$383
FFTDG3060H30	37.75 x 60 x 30.60	125	49	7.87	\$1965	\$396
FFTDG3066H30	37.75 x 66 x 30.60	150	50.55	8.65	\$2016	\$409
FFTDG3072H30	37.75 x 72 x 30.60	150	52.10	9.44	\$2041	\$409
FFTDG3078H30	37.75 x 78 x 30.60	150	53.65	10.22	\$2120	\$429
FFTDG3084H30	37.75 x 84 x 30.60	150	55.20	11.01	\$2172	\$436

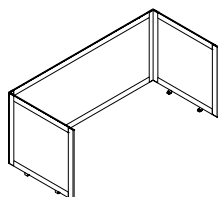

30" H Single Table Glass Divider Screen

Provides privacy in an open plan environment. Easy to clean table mounted partitions. Powder coated aluminum frame with 4mm clear (CLR) glass. Includes all hardware to connect. Brackets are painted steel. Side dividers extend 6.237" from the front edge of each surface. Back divider extends over the back edge of the worksurface by 1.5", allowing for cable pass-through to trough. Width and depth are nominal sizes representing the sizes of the Bridges configuration. Allow for .25" overhang at the sides, 1.5" at the back, and 6.237" at the front. Frame and hardware available in Black (BLK), Charcoal (CHR), Designer White (DWT), Fog (FOG), Nevada (NEV), Silver (SIL), Taupe (TPE), Tungsten (TUN). End trim cap is only available in Charcoal (CHR). **Add 20%** upcharge for frosted glass (FRST).

- **FFTDG24xxH30 are for configurations with 24" deep surfaces.**
- **FFTDG30xxH30 are for configurations with 30" deep surfaces.**

Required specifications
Frame finish

Optional specifications
Frosted glass (FRST)

FELT DIVIDER SCREENS

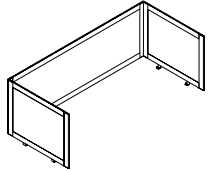

24" H Single Table Felt Divider Screen

MODEL#	DIMENSIONS	FREIGHT CLASS	WT./LBS.	CUBIC FT.	LIST PRICE
D x W x H					
FFTDF2436H24	31.50 x 36 x 24.60	125	22.55	3.94	\$937
FFTDF2442H24	31.50 x 42 x 24.60	125	24.10	4.59	\$961
FFTDF2448H24	31.50 x 48 x 24.60	150	25.65	5.25	\$986
FFTDF2454H24	31.50 x 54 x 24.60	150	27.20	5.91	\$1010
FFTDF2460H24	31.50 x 60 x 24.60	150	28.75	6.56	\$1037
FFTDF2466H24	31.50 x 66 x 24.60	150	30.30	7.22	\$1063
FFTDF2472H24	31.50 x 72 x 24.60	150	31.85	7.88	\$1086
FFTDF2478H24	31.50 x 78 x 24.60	150	33.40	8.53	\$1111
FFTDF2484H24	31.50 x 84 x 24.60	150	34.95	9.19	\$1160
FFTDF3036H24	37.75 x 36 x 24.60	100	36.50	4.72	\$968
FFTDF3042H24	37.75 x 42 x 24.60	125	38.05	5.51	\$1056
FFTDF3048H24	37.75 x 48 x 24.60	125	39.60	6.29	\$1019
FFTDF3054H24	37.75 x 54 x 24.60	150	41.15	7.08	\$1044
FFTDF3060H24	37.75 x 60 x 24.60	150	41.70	7.87	\$1069
FFTDF3066H24	37.75 x 66 x 24.60	150	44.25	8.65	\$1095
FFTDF3072H24	37.75 x 72 x 24.60	150	45.80	9.44	\$1117
FFTDF3078H24	37.75 x 78 x 24.60	150	47.35	10.22	\$1142
FFTDF3084H24	37.75 x 84 x 24.60	150	48.90	11.01	\$1193

Provides privacy in an open plan environment. Powder coated aluminum frame with 9mm felt. Includes all hardware to connect. Brackets are painted steel. Side dividers extend 6.237" from the front edge of each surface. Back divider extends over the back edge of the worksurface by 1.5", allowing for cable pass-through to trough. Width and depth are nominal sizes representing the sizes of the FreeFit table. Allow for .25" overhang at the sides, 1.5" at the back, and 6.237" at the front. Frame and hardware available in Black (BLK), Charcoal (CHR), Designer White (DWT), Fog (FOG), Nevada (NEV), Silver (SIL), Taupe (TPE), Tungsten (TUN). End trim cap is only available in Charcoal (CHR). 9mm PET felt material is tackable and available in 9 colors.

- FFTDF24xxH24 are for configurations with 24" deep surfaces.
- FFTDF30xxH24 are for configurations with 30" deep surfaces.

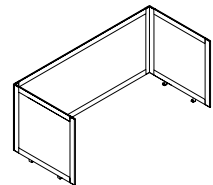

30" H Single Table Felt Divider Screen

FFTDF2436H30	31.50 x 36 x 30.60	125	24.85	3.97	\$930
FFTDF2442H30	31.50 x 42 x 30.60	125	26.40	4.59	\$954
FFTDF2448H30	31.50 x 48 x 30.60	125	27.95	5.25	\$976
FFTDF2454H30	31.50 x 54 x 30.60	150	29.50	5.91	\$999
FFTDF2460H30	31.50 x 60 x 30.60	150	31.05	6.56	\$1022
FFTDF2466H30	31.50 x 66 x 30.60	150	32.60	7.22	\$1045
FFTDF2472H30	31.50 x 72 x 30.60	150	34.14	7.88	\$1069
FFTDF2478H30	31.50 x 78 x 30.60	150	34.70	8.53	\$1092
FFTDF2484H30	31.50 x 84 x 30.60	150	37.25	9.19	\$1147
FFTDF3036H30	37.75 x 36 x 30.60	100	38.80	4.72	\$975
FFTDF3042H30	37.75 x 42 x 30.60	100	40.35	5.51	\$998
FFTDF3048H30	37.75 x 48 x 30.60	125	41.90	6.29	\$1021
FFTDF3054H30	37.75 x 54 x 30.60	125	43.45	7.08	\$1044
FFTDF3060H30	37.75 x 60 x 30.60	125	45	7.87	\$1069
FFTDF3066H30	37.75 x 66 x 30.60	150	46.55	8.65	\$1092
FFTDF3072H30	37.75 x 72 x 30.60	150	48.10	9.44	\$1114
FFTDF3078H30	37.75 x 78 x 30.60	150	49.65	10.22	\$1137
FFTDF3084H30	37.75 x 84 x 30.60	150	51.20	11.01	\$1191

Provides privacy in an open plan environment. Powder coated aluminum frame with 9mm felt. Includes all hardware to connect. Brackets are painted steel. Side dividers extend 6.237" from the front edge of each surface. Back divider extends over the back edge of the worksurface by 1.5", allowing for cable pass-through to trough. Width and depth are nominal sizes representing the sizes of the Bridges configuration. Allow for .25" overhang at the sides, 1.5" at the back, and 6.237" at the front. Frame and hardware available in Black (BLK), Charcoal (CHR), Designer White (DWT), Fog (FOG), Nevada (NEV), Silver (SIL), Taupe (TPE), Tungsten (TUN). End trim cap is only available in Charcoal (CHR). 9mm PET felt material is tackable and available in 9 colors.

- FFTDF24xxH30 are for configurations with 24" deep surfaces.
- FFTDF30xxH30 are for configurations with 30" deep surfaces.

Required Specifications

Frame finish
Felt finish