

Flip-N-Go® Conference/Training Tables

Safco® Products marketing materials are designed to be used as sales tools for our Dealer network.

- Minimal assembly required
- Dual-sided levers for a quick flip of the top
- Tables nest for compact storage
- Integrated Modesty Panel with built-in cable trough
- Tables can be connected together by using ganging kit (included)
- Tables are shipped in two boxes, top and base separately
- Overall HPL table height: 29"
- Four locking casters
- 5¼" between tables when nested
- 150 lb. weight capacity, Evenly distributed
- Base available in Black or Silver Finishes
- Tables available in either Thermally Fused Laminate (TFL) with standard T-Mold or High Pressure Laminate (HPL) with your choice of 3 edge treatments
- HPL Edge Treatments: 3mm (H3), Knife-Edge (HK) or Standard T-Mold (HT) available in corporate edge colors
- Manufactured cutouts (5¼ x 3") for daisy chain electrical kits available on 24"D rectangular tables (one centered cutout per table grommet not included)
- Add "E" suffix and \$30 list upcharge per cutout
- Power Options page 230 for surface mount kits

How to Specify

Start with base model number and **SELECT ONE CODE FROM EACH OF THE OPTIONS** to complete your final model number for ordering:

Select MODEL NUMBER (ie., LF2448)	Step 1: Select [✦] CUTOUT (OPTIONAL)	Step 2: Select [■] LAMINATE/EDGE TYPE
	E = Rectangular (Cutout Only) (Add \$30 List)	H3 = HPL Laminate /3mm Edge
	G = Center Grommet (Add \$30 List)	HK = HPL Laminate /Knife Edge HT = HPL Laminate /T-Mold Edge
	M = Left/Right (2) Grommets (Add \$60 List)	T = TFL Laminate /T-Mold Edge

Add codes to indicate your selections: E (Rectangular Cutout Only) H3 (HPL Laminate /3mm Edge)

The final Model Number for Base Product LF2448 with the highlighted selections would be LF2448-E-H3 (or LF2448EH3).

• See next page for Cutout and Laminate/Edge options

Note: All non-standard cutouts (other than above) will be reviewed to determine if the cutout does not interfere with the base, degrade table strength or cause imbalance. Contact specials@safcoproducts.com for quote request and drawing signoff will be required before order is processed.

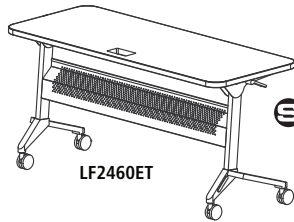

Rectangular Surfaces GSA S

Model No.	Description	Wt.	Available Cutouts	TFL List Price "T" Suffix	HPL List Price HT, HK or H3 Suffix
LF1848	48 x 18" Rectangular	66	G	674.00	718.00
LF1860	60 x 18" Rectangular	76	G,M	718.00	796.00
LF1872	72 x 18" Rectangular	86	G,M	766.00	841.00
LF2448	48 x 24" Rectangular	76	E,G	718.00	796.00
LF2460	60 x 24" Rectangular	86	E,G,M	796.00	872.00
LF2472	72 x 24" Rectangular	96	E,G,M	841.00	934.00

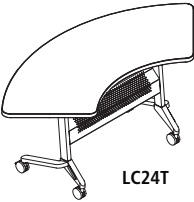

Crescent Surfaces (48" Radius) GSA S

LC24	67 x 24" Crescent	76	-	858.00	934.00
------	-------------------	----	---	--------	--------

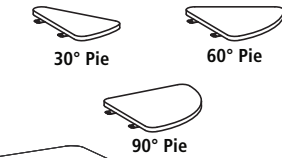

Trapezoid Surfaces GSA S

LP24	60 x 24" Trapezoid	76	-	766.00	828.00
------	--------------------	----	---	--------	--------

Pie Connectors GSA S

P3018	18" x 30° Pie	4	-	260.00	291.00
P6018	18" x 60° Pie	8	-	273.00	305.00
P9018	18" x 90° Pie	12	-	291.00	322.00
P3024	24" x 30° Pie	6	-	260.00	291.00
P6024	24" x 60° Pie	12	-	273.00	305.00
P9024	24" x 90° Pie	18	-	291.00	322.00

Transition Tables (Surfaces can be installed in either direction) GSA S

LT24	48"W x 24"D	76	-	859.00	934.00
------	-------------	----	---	--------	--------

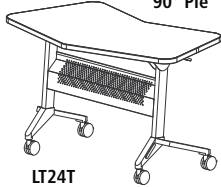

Flip-N-Go® Conference/Training Tables - Quick Ship Options

- Low pressure laminate tabletop with Black T-mold edge band
- Laminate top options: Regal Mahogany (RMH), Folkstone (FLK4), Cherry (LCRM), Mocha (LDCM)
- Black (S) or Silver (SLV) base to match workspace décor

Example of ordering Quick Ship Model Number for Black (S) Base Product LF2448T with the selected laminate color would be LF2448T-S-FLK4 (or LF2448TSFLK4).

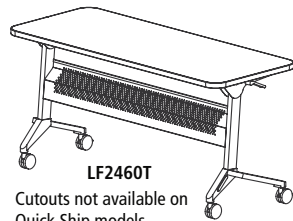

Rectangular Surfaces GSA S

Model No.	Description	Wt.	List Price
LF1848T	48 x 18" Rectangular	66	718.00
LF1860T	60 x 18" Rectangular	76	796.00
LF1872T	72 x 18" Rectangular	86	841.00
LF2448T	48 x 24" Rectangular	76	796.00
LF2460T	60 x 24" Rectangular	86	872.00
LF2472T	72 x 24" Rectangular	96	934.00

Cutouts not available on Quick Ship models

Cutout Options [♣]

"E" - \$30 List upcharge

(1) Manufactured rectangular cutout 5 1/4 x 3" for daisy chain electrical kits only. Grommet caps not included with cutout. See page 230 for available kit options.



Cutout-E

"G" - \$30 List upcharge

(1) Manufactured round cutout 1 3/4" in diameter located in center approach side of top. Includes grommet cap. Black only.



Cutout-G

"M" - \$60 List upcharge

(2) Manufactured round cutouts 1 3/4" diameter located on right and left approach side of top. Includes (2) grommet caps. Black only.



Cutout-M

Laminate Edge Type [■]

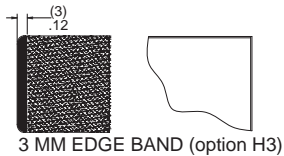

3 MM EDGE BAND (option H3)

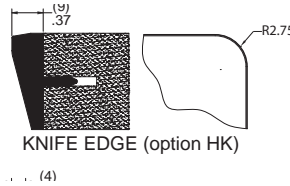

KNIFE EDGE (option HK)

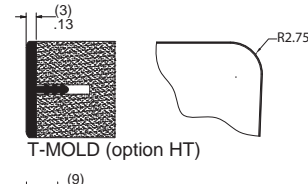

T-MOLD (option HT)

Note: All non-standard cutouts (other than above) will be reviewed to determine if the cutout does not interfere with the base, degrade table strength or cause imbalance. Contact specials@safcoproducts.com for quote request and drawing signoff will be required before order is processed.

Flip-N-Go® Conference/Training Tables - Idea Starters

• Must order by individual model numbers.



Flip-N-Go Typical #1

Consists of:

Qty.	Model No.	Description	List Price Each
4	LF2460T	Rectangular Table, 24 x 60"	796.00
2	LT24T	24"D Transition Table	859.00
2	P3024T	24" x 30° Pie	260.00

Total: 5,422.00

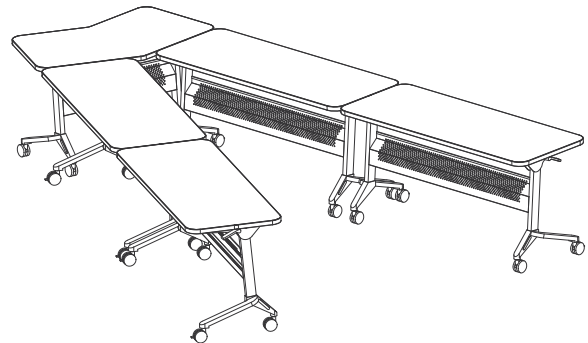

Flip-N-Go Typical #2

Consists of:

Qty.	Model No.	Description	List Price Each
4	LF2460T	Rectangular Table, 24 x 60"	796.00
1	LT24T	24"D Transition Table	859.00

Total: 4,043.00

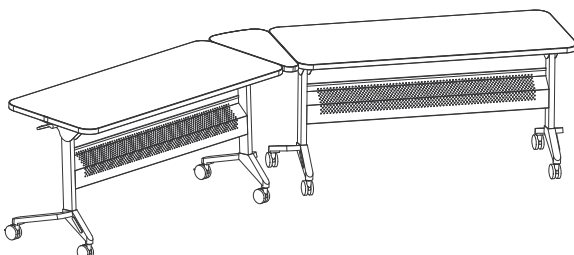

Flip-N-Go Typical #3

Consists of:

Qty.	Model No.	Description	List Price Each
2	LF2460T	Rectangular Table, 24 x 60"	796.00
1	P3024T	24" x 30° Pie	260.00

Total: 1,852.00