

# Cohere™ Tables - Flip & Nest

Safco® Products marketing materials are designed to be used as sales tools for our Dealer network.

- This table is available in T-Leg configuration only
- Surfaces are constructed with 1 1/8" thick high pressure laminate with 3mm T-Mold or 3mm Edgeband
- Optional frosted acrylic modesty panels are available and attach to the underside of the surface
- This table is available with casters only. 3" locking, non-marring Black casters are standard

- Optional premium 3" White nylon caster with locking Gray urethane anti-vibration tread for smooth and quiet movement is available
- Flipping mechanism and stabilizer bar in Silver finish only
- Overall table height is 29" from floor to top of 1 1/8" surface
- Legs/Feet available in Black, Silver or White powder coat finishes
- Optional polished aluminum feet are available for an upcharge
- Optional premium Caster Kit available - order model FWCAST

## HOW TO SPECIFY

Start with base model number and **SELECT ONE CODE FROM EACH OF THE OPTIONS** to complete your final model number for ordering:

Select MODEL NUMBER (ie., FR1848)	Option 1 [⚡] EDGE	Option 2 [■] CUTOUT	Option 3 [●] LEG STYLE	Option 4 [✓] FOOT FINISH	Option 5 [✕] CASTER
	H3 = Edge Band (Square Corner)	N = No Grommet (No Power)	T = T-Leg Only	P = Standard (Same Color)	S = Standard Black Only
	HT = T-Mold (Radius Corner)	G = Center Grommet Only + \$30 M = Left/Right Grommet + \$60 E = Rectangular (Cutout Only) + \$30		A = Polished Aluminum Feet + \$42 List	

Add codes to indicate options you would like: **H3** (with Edge Band)    **N** (Without Grommet)    **T** (With T-Leg Only)    **P** (in Standard Color)    **S** (Standard Black Only)

The final model number for base product FR1848 with the highlighted options would be FR1848-H3-N-T-P-S (or FR1848H3NTPS).

Note: All non-standard cutouts (other than above) will be reviewed to determine if the cutout does not interfere with the base, degrade table strength or cause imbalance. Contact spaceplanning@safcoproducts.com for quote request and drawing signoff will be required before order is processed.

### laminate edge type [⚡]

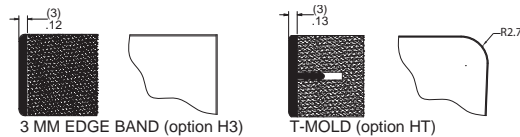

### Cutout Options [■]

#### G - \$30 List upcharge

(1) Manufactured round cutout 1 3/4" in diameter located in center approach side of top. Includes grommet cap. Black only.



Cutout-G

#### M - \$60 List upcharge

(2) Manufactured round cutouts 1 3/4" diameter located on right and left approach side of top. Includes (2) grommet caps. Black only.



Cutout-M

#### E - \$30 List upcharge

(1) Manufactured rectangular cutout 5 1/4 x 3" for daisy chain electrical kits only. Grommet caps not included with cutout.



Cutout-E

## Cohere™ Tables - Acrylic Modesty Panels - Flip & Nest Style

- Brackets available in your choice of Black, White or Silver powder coat finish

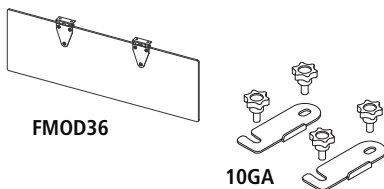

Model No.	Description	Wt.	List Price
FMOD36	30"W x 10"H - For 36" & Transition Table	7	323.00
FMOD42	36"W x 10"H - For 42" Table	8	333.00
FMOD48	42"W x 10"H - For 48" Table	9	358.00
FMOD54	48"W x 10"H - For 54" Table	10	381.00
FMOD60	54"W x 10"H - For 60" Table	11	405.00
FMOD66	60"W x 10"H - For 66" Table	12	439.00
FMOD72	66"W x 10"H - For 72" Table	13	463.00
10GA	Universal Ganging Accessory	1	62.00
Optional White Caster			
FWCAST	Cohere Premium Caster Kit, set of 4		76.00

## Cohere™ Tables - Steel Modesty Panels - Flip & Nest Style

- Brackets available in your choice of Black, White or Silver paint
- Steel Modesty panels are available in your choice of Corporate Paint Colors

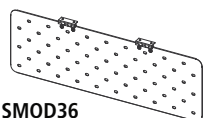

Model No.	Description	Wt.	List Price
SMOD36	30"W x 10"H - For 36" & Transition Table	7	166.00
SMOD42	36"W x 10"H - For 42" Table	8	177.00
SMOD48	42"W x 10"H - For 48" Table	9	189.00
SMOD54	48"W x 10"H - For 54" Table	10	192.00
SMOD60	54"W x 10"H - For 60" Table	11	199.00
SMOD66	60"W x 10"H - For 66" Table	12	210.00
SMOD72	66"W x 10"H - For 72" Table	13	222.00

**Specification Tips:**

- Overall footprint depth is 20½" for 24"D table. Each additionally nested table adds 7½" in total footprint depth. Total depth for 3 tables would be 35½"
- 54" W surfaces and smaller are available with a center grommet option only. 60" W surface and larger are also available with two grommets positioned on the left and right
- Circular grommet cutouts are 1¾" diameter and located 3½" from the rear of the surface and 7" from the end for the left and right option. Grommets are available in Black only and only on rectangular tops
- Support beam provides integrated cable management clips
- Optional ganging hardware is available. Specify one package per seam
- Access to all standard Wilsonart®, Nevamar®, Formica® and Pionite® laminates is available



FR1848HTGTPS

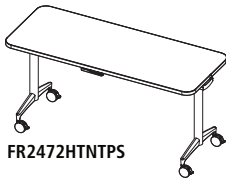

FR2472HTNTPS

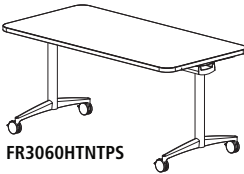

FR3060HTNTPS

Model No.	Options:					Description	Optional Cutouts	Wt.	List Price
<b>Rectangular</b>									
	1	2	3	4	5				
FR1848			T		S	48 x 18" Rectangular	G	52	1,027.00
FR1860			T		S	60 x 18" Rectangular	G, M	61	1,050.00
FR1872			T		S	72 x 18" Rectangular	G, M	69	1,128.00
FR2436			T		S	36 x 24" Rectangular	G	55	1,027.00
FR2442			T		S	42 x 24" Rectangular	G	60	1,044.00
FR2448			T		S	48 x 24" Rectangular	G, E	65	1,064.00
FR2454			T		S	54 x 24" Rectangular	G, E	71	1,080.00
FR2460			T		S	60 x 24" Rectangular	G, M, E	76	1,093.00
FR2466			T		S	66 x 24" Rectangular	G, M, E	82	1,189.00
FR2472			T		S	72 x 24" Rectangular	G, M, E	87	1,254.00
FR3036			T		S	30 x 36" Rectangular	G	68	1,086.00
FR3042			T		S	30 x 42" Rectangular	G	73	1,110.00
FR3048			T		S	48 x 30" Rectangular	G, E	78	1,135.00
FR3054			T		S	54 x 30" Rectangular	G, E	85	1,153.00
FR3060			T		S	60 x 30" Rectangular	G, M, E	92	1,183.00
FR3066			T		S	66 x 30" Rectangular	G, M, E	98	1,290.00
FR3072			T		S	72 x 30" Rectangular	G, M, E	105	1,337.00
FR3648			T		S	48 x 36" Rectangular	G, E	91	1,284.00
FR3660			T		S	60 x 36" Rectangular	G, M, E	107	1,421.00
FR3672			T		S	72 x 36" Rectangular	G, M, E	123	1,493.00

**Cohere™ Transition Tables**



FT2448HTNTPS

<b>Transition Tables</b>									
Options:	1	2	3	4	5	Description	Optional Cutouts	Wt.	List Price
FT2448		N	T		S	48 x 24" Transition	N/A	62	1,064.00
FT3048		N	T		S	48 x 30" Transition	N/A	69	1,135.00

**Cohere™ Half Round Tables**



FH2448

<b>Half Round Tables</b>									
Options:	1	2	3	4	5	Description	Optional Cutouts	Wt.	List Price
FH2448		N	T		S	24 x 48" Half Round	N/A	62	1,064.00
FH3060		N	T		S	30 x 60" Half Round	N/A	69	1,183.00
FH3672		N	T		S	36 x 72" Half Round	N/A	75	1,493.00

Office Suites  
Seating  
Tables & Desks  
Meeting Essentials  
Personal Organization  
Ergonomics  
High Density Storage  
Storage & Filing  
Facilities  
Technology Furniture  
Art & Engineering  
K-12 Education

**Fixed-Height Tables**

- Surfaces are constructed with 1 1/8" thick high pressure laminate with 3mm T-Mold or 3mm Edgeband
- This table is available with Black glides (Glides have 1/2" leveling range) or 3" Black locking casters
- Overall table height is 29" from floor to top of 1 1/8" surface
- Base available in Black, Silver or White powder coat finishes
- Glides and casters are not field interchangeable as the overall table height will be affected

**How to Specify**

Start with base model number and **SELECT ONE CODE FROM EACH OF THE OPTIONS** to complete your final model number for ordering:

Select MODEL NUMBER (ie., HR1848)	Option 1 [♣] EDGE	Option 2 [■] CUTOUT	Option 3 [●] LEG STYLE	Option 4 [✓] FOOT FINISH
	H3 = Edge Band (Square Corner)	N = No Grommet (No Power)	T = T-Leg with Glide	P = Standard (Same Color)
	HT = T-Mold (Radiused Corner)	G = Center Grommet Only + \$30 M = Left/Right Grommet + \$60 E = Rectangular (Cutout only) + \$30	C = C-Leg with Glide  R = T-Leg with Standard Caster + \$42	A = Polished Aluminum Feet + \$42 List
Add codes to indicate options you would like:	<b>H3</b> (with Edge Band)	<b>N</b> (Without Grommet)	<b>T</b> (with T-Leg Style)	<b>P</b> (in Standard Color)

The final model number for Base Product HR1848 with the highlighted options would be HR1848-H3-N-T-P (or HR1848H3NTP).

**Note:** All non-standard cutouts (other than above) will be reviewed to determine if the cutout does not interfere with the base, degrade table strength or cause imbalance. Contact spaceplanning@safcoproducts.com for quote request and drawing signoff will be required before order is processed.

**Cutout Options [■]**

**G - \$30 List upcharge**

(1) Manufactured round cutout 1 3/4" in diameter located in center approach side of top. Includes grommet cap. Black only.



Cutout-G

**M - \$60 List upcharge**

(2) Manufactured round cutouts 1 3/4" diameter located on right and left approach side of top. Includes (2) grommet caps. Black only.



Cutout-M

**E - \$30 List upcharge**

(1) Manufactured rectangular cutout 5 1/4 x 3" for daisy chain electrical kits only. Grommet caps not included with cutout.

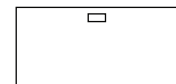

Cutout-E

**Laminate Edge Type [♣]**

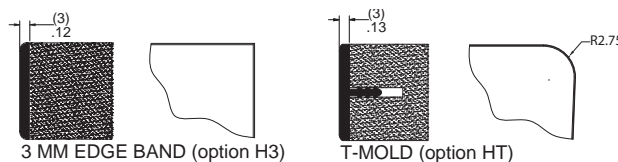

Office Suites  
Seating  
Tables & Desks  
Meeting Essentials  
Personal Organization  
Ergonomics  
High Density Storage  
Storage & Filing  
Facilities  
Technology Furniture  
Art & Engineering  
K-12 Education

**Specification Tips:**

- C-Legs are available only in 24" and 30" deep surfaces
- **54"W surfaces and smaller are available with a center grommet option only. 60"W surface and larger are also available with two grommets positioned on the left and right**
- Grommet cutouts are 1¾" diameter and located 3½" from the rear of the surface and 7" from the end for the left and right option. Grommets are available in Black only
- All surfaces 60" and longer utilize a steel reinforcement bar to prevent surface deflection
- Optional ganging hardware is available. Specify one package per seam
- These tables are designed for static use applications only. They are not designed to be slid and/or dragged across any floor space. For applications requiring mobility, please refer to one of our many mobile training options
- Access to all standard Wilsonart®, Nevamar®, Formica® and Pionite® laminates is available

**Cohere™ Rectangular Fixed-Height**

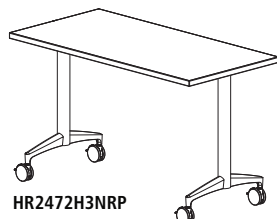
Model No.	Options:				Description	- Optional Cutouts	Wt.	List Price
	1	2	3	4				
 HR2472H3NRP	✘	✘	✘	✔	48 x 18" Rectangular	G	44	739.00
HR1848	✘	✘	✘	✔	48 x 18" Rectangular	G	44	739.00
HR1860	✘	✘	✘	✔	60 x 18" Rectangular	G, M	52	775.00
HR1872	✘	✘	✘	✔	72 x 18" Rectangular	G, M	59	811.00
HR2436	✘	✘	✘	✔	36 x 24" Rectangular	G	47	759.00
HR2442	✘	✘	✘	✔	42 x 24" Rectangular	G	52	775.00
HR2448	✘	✘	✘	✔	48 x 24" Rectangular	G, E	57	795.00
HR2454	✘	✘	✘	✔	54 x 24" Rectangular	G, E	62	831.00
HR2460	✘	✘	✘	✔	60 x 24" Rectangular	G, M, E	67	841.00
HR2466	✘	✘	✘	✔	66 x 24" Rectangular	G, M, E	72	884.00
HR2472	✘	✘	✘	✔	72 x 24" Rectangular	G, M, E	77	901.00
HR3036	✘	✘	✘	✔	36 x 30" Rectangular	G	53	835.00
HR3042	✘	✘	✘	✔	42 x 30" Rectangular	G	60	841.00
HR3048	✘	✘	✘	✔	48 x 30" Rectangular	G, E	70	854.00
HR3054	✘	✘	✘	✔	54 x 30" Rectangular	G, E	76	859.00
HR3060	✘	✘	✘	✔	60 x 30" Rectangular	G, M, E	83	877.00
HR3066	✘	✘	✘	✔	66 x 30" Rectangular	G, M, E	89	901.00
HR3072	✘	✘	✘	✔	72 x 30" Rectangular	G, M, E	95	920.00
HR3648	✘	✘	✘	✔	48 x 36" Rectangular	G, E	83	901.00
HR3660	✘	✘	✘	✔	60 x 36" Rectangular	G, M, E	98	972.00
HR3672	✘	✘	✘	✔	72 x 36" Rectangular	G, M, E	113	1,044.00

\* NOTE: C-Leg not available on 18"D.

- Optional CPU bracket available on 60" and larger tops for additional charge (model # C894) found on page 233.
- Optional keyboard (model #195TKLS), found on page 233 also works with the above Cohere tables.

**Cohere™ Fixed-Height Transition Table**

Model No.	Options:				Description	Optional Cutouts	Wt.	List Price
	1	2	3	4				
 HT2448HTNCP	✘	N	✘	✔	48 x 24" Transition	N/A	59	795.00
HT3048	✘	N	✘	✔	48 x 30" Transition	N/A	66	854.00

Office Suites  
Seating  
Tables & Desks  
Meeting Essentials  
Personal Organization  
Ergonomics  
High Density Storage  
Storage & Filing  
Facilities  
Technology Furniture  
Art & Engineering  
K-12 Education

- Available in T-Leg configuration only
- Under table clearance is 25<sup>7</sup>/<sub>8</sub>" to 33<sup>7</sup>/<sub>8</sub>"
- Table height from floor to top of surface ranges from 26" to 34" on 1" increments (8" travel range)
- Meets ADA height of 32"
- Surfaces are constructed with 1<sup>1</sup>/<sub>8</sub>" thick high pressure laminate with 3mm Edgeband or 3mm T-Mold

- Available with Black glides (Glides have 1/2" leveling range) or 3" Black locking casters
- Base available in Black, Silver or White powder coat finishes
- Glides and casters are not field interchangeable
- Glides have 1/2" leveling range

## How to Specify

Start with base model number and **SELECT ONE CODE FROM EACH OF THE OPTIONS** to complete your final model number for ordering:

Select MODEL NUMBER (ie., PR1848)	Option 1 [♣] EDGE	Option 2 [■] CUTOUT	Option 3 [●] LEG STYLE	Option 4 [✓] FOOT FINISH
	H3 = Edgeband (Square Corner)	N = No Grommet (No Power)	T = T-Leg with Glide	P = Standard (Same Color)
	HT = T-Mold (Radiused Corner)	G = Center Grommet Only + \$30	R = T-Leg with Standard Caster + \$42	A = Polished Aluminum Feet + \$42 List
		M = Left/Right Grommet + \$60		
Add codes to indicate options you would like:	H3 (with Edge Band)	N (Without Grommet)	T (T-Leg with Glide)	P (in Standard Color)

The final model number for Base Product PR1848 with the highlighted options would be PR1848-H3-N-T-P (or PR1848H3NTP).

**Note:** All non-standard cutouts (other than above) will be reviewed to determine if the cutout does not interfere with the base, degrade table strength, or cause imbalance. Contact [spaceplanning@safcoproducts.com](mailto:spaceplanning@safcoproducts.com) for quote request and drawing signoff will be required before order is processed.

### Cutout Options [■]

#### G - \$30 List upcharge

(1) Manufactured round cutout 1<sup>3</sup>/<sub>4</sub>" in diameter located in center approach side of top. Includes grommet cap. Black only.



Cutout-G

#### M - \$60 List upcharge

(2) Manufactured round cutouts 1<sup>3</sup>/<sub>4</sub>" diameter located on right and left approach side of top. Includes (2) grommet caps. Black only.



Cutout-M

### Laminate Edge Type [♣]

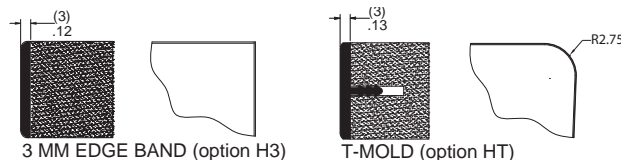

3 MM EDGE BAND (option H3)

T-MOLD (option HT)

Training Table Power Options available for fixed-height tables. Please see page 233.

## Cohere™ Tables - Acrylic Modesty Panel - Fixed & Pin Style

- Brackets available in your choice of Black, White or Silver powder coat finish

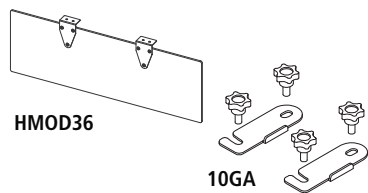

HMOD36

10GA

Model No.	Description	Wt.	List Price
HMOD36	30"W x 10"H - For 36" & Transition Table	7	323.00
HMOD42	36"W x 10"H - For 42" Table	8	333.00
HMOD48	42"W x 10"H - For 48" Table	9	358.00
HMOD54	48"W x 10"H - For 54" Table	10	381.00
HMOD60	54"W x 10"H - For 60" Table	11	405.00
HMOD66	60"W x 10"H - For 66" Table	12	439.00
HMOD72	66"W x 10"H - For 72" Table	13	463.00
10GA	Universal Ganging Accessory	1	62.00
<b>Optional White Caster</b>			
FWCAST	Cohere Premium Caster Kit, set of 4		76.00

## Cohere™ Tables - Steel Modesty Panel - Fixed & Pin Style

- Steel Modesty panels are available in your choice of Corporate Paint Colors

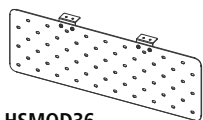

HSMOD36

Model No.	Description	Wt.	List Price
HSMOD36	30"W x 10"H - For 36" & Transition Table	7	166.00
HSMOD42	36"W x 10"H - For 42" Table	8	177.00
HSMOD48	42"W x 10"H - For 48" Table	9	189.00
HSMOD54	48"W x 10"H - For 54" Table	10	192.00
HSMOD60	54"W x 10"H - For 60" Table	11	199.00
HSMOD66	60"W x 10"H - For 66" Table	12	210.00
HSMOD72	66"W x 10"H - For 72" Table	13	222.00

**Specification Tips:**

- 54"W surfaces and smaller are available with a center grommet option only. 60"W surface and larger are also available with two grommets positioned on the left and right
- Grommet cutouts are 1¼" round and located 3½" from the rear of the surface and 7" from the end for the left and right option. Grommets are available in Black only
- All surfaces 60" and longer utilize a steel reinforcement bar to prevent surface deflection
- Optional ganging hardware is available. Specify one package per seam
- Access to all standard Wilsonart®, Nevamar®, Formica® and Pionite® laminates is available

**Cohere™ Rectangular Pin-Height Adjustable Tables**

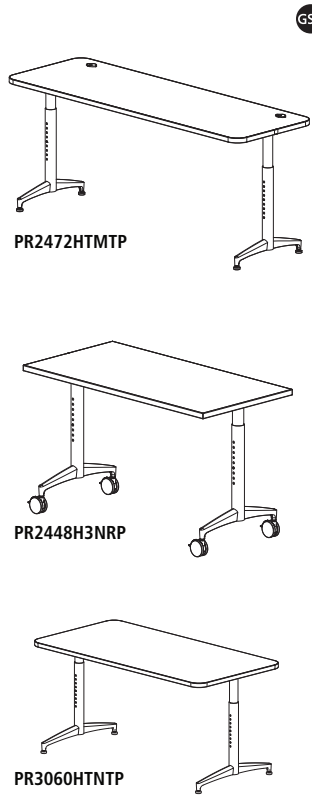

Model No.	Options:				Description	Optional Cutouts	Wt.	List Price
	1	2	3	4				
PR1848	✘	■	●	✓	48 x 18" Rectangular	G	50	1,080.00
PR1860	✘	■	●	✓	60 x 18" Rectangular	G, M	58	1,153.00
PR1872	✘	■	●	✓	72 x 18" Rectangular	G, M	65	1,183.00
PR2436	✘	■	●	✓	36 x 24" Rectangular	G	53	1,080.00
PR2442	✘	■	●	✓	42 x 24" Rectangular	G	58	1,128.00
PR2448	✘	■	●	✓	48 x 24" Rectangular	G	63	1,135.00
PR2454	✘	■	●	✓	54 x 24" Rectangular	G	68	1,176.00
PR2460	✘	■	●	✓	60 x 24" Rectangular	G, M	73	1,199.00
PR2466	✘	■	●	✓	66 x 24" Rectangular	G, M	78	1,235.00
PR2472	✘	■	●	✓	72 x 24" Rectangular	G, M	83	1,277.00
PR3036	✘	■	●	✓	36 x 30" Rectangular	G	71	1,176.00
PR3048	✘	■	●	✓	48 x 30" Rectangular	G	76	1,199.00
PR3054	✘	■	●	✓	54 x 30" Rectangular	G	82	1,259.00
PR3060	✘	■	●	✓	60 x 30" Rectangular	G, M	89	1,295.00
PR3066	✘	■	●	✓	66 x 30" Rectangular	G, M	95	1,319.00
PR3072	✘	■	●	✓	72 x 30" Rectangular	G, M	101	1,337.00
PR3648	✘	■	●	✓	48 x 36" Rectangular	G	89	1,284.00
PR3660	✘	■	●	✓	60 x 36" Rectangular	G, M	104	1,378.00
PR3672	✘	■	●	✓	72 x 36" Rectangular	G, M	119	1,421.00

• Optional CPU bracket available on 60" and larger tops for additional charge (model # C894) found on page 233.  
 Optional keyboard (model #195TKLS), found on page 233 also works with above Cohere tables.

**Cohere™ Transition Pin-Height Adjustable Tables**

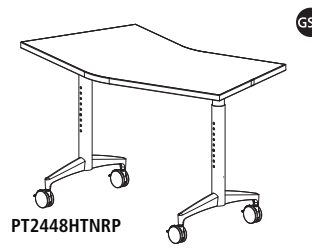

Model No.	Options:				Description	Optional Cutouts	Wt.	List Price
	1	2	3	4				
PT2448	✘	N	●	✓	48"W x 24"H Transition	N/A	59	1,135.00
PT3048	✘	N	●	✓	48"W x 30"H Transition	N/A	66	1,199.00

Office Suites  
 Seating  
 Tables & Desks  
 Meeting Essentials  
 Personal Organization  
 Ergonomics  
 High Density Storage  
 Storage & Filing  
 Facilities  
 Technology Furniture  
 Art & Engineering  
 Education  
 K-12

### Specification Tips:

- Surfaces are constructed with 1 1/8" thick high pressure laminate with 3mm Edgeband or 3mm T-Mold
- This table is available with Black glides only. Glides have 1/2" leveling range
- Overall dining table height is 29" from floor to top of 1 1/8" surface. Overall bar table height is 42" from floor to top of 1 1/8" surface
- Base available in Black, Silver or White powder coat finishes
- Bases ship fully assembled
- Optional polished aluminum feet are available for an upcharge
- Access to all standard Wilsonart®, Nevamar®, Formica® and Pionite® laminates is available

### How to Specify

Start with base model number and **SELECT ONE CODE FROM THE OPTION** to complete your final model number for ordering:

Select MODEL NUMBER (ie., HD1848)	Option 1 [❖] EDGE	Option 2 [■] FOOT FINISH
	H3 = Edge Band (Square Corner)	P = Standard (Same Color)
	HT = T-Mold (Radiused Corner)	A = Polished Aluminum + \$42 List
Add codes to indicate options you would like:	<b>H3</b> (with Edge Band)	<b>P</b> (in Standard Color)

The final Model Number for Base Product HD24D with the highlighted options would be HD24D-H3-P (or HD24DH3P).

### Edge Options

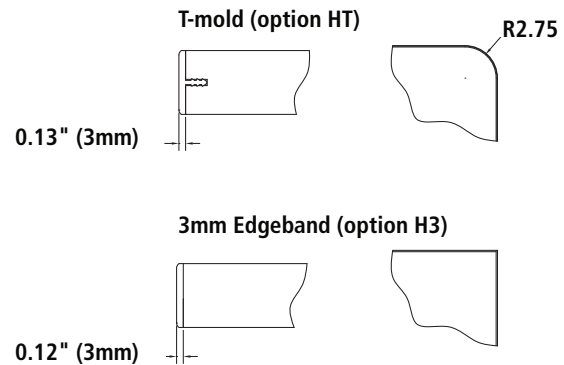

# Cohere™ Tables - Hospitality Tables

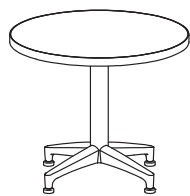

HD24DHTP



HB24SHTP

Model No.	Description	Wt.	List Price
<b>29" H Dining Height</b>			
Option:	1	2	
HD24D	24" Round	32	767.00
HD30D	30" Round	42	810.00
HD36D	36" Round	52	925.00
HD42D	42" Round	66	1,024.00
HD24S	24" Square	36	767.00
HD30S	30" Square	48	810.00
HD36S	36" Square	63	925.00
HD42S	42" Square	80	1,024.00
<b>42" H Bar Height</b>			
Option:	1	2	
HB24D	24" Round	33	792.00
HB30D	30" Round	43	834.00
HB36D	36" Round	54	951.00
HB42D	42" Round	68	1,046.00
HB24S	24" Square	37	792.00
HB30S	30" Square	49	834.00
HB36S	36" Square	64	951.00
HB42S	42" Square	81	1,046.00

**HOW TO SPECIFY:** Select Model No. & Add Suffix Codes

<b>OPTION 1</b> [❖]	Select EDGE Edgeband (H3) T-Mold (HT)	<b>OPTION 2</b> [■]	Select FOOT Finish Standard (P) Pol. Alum. (A)*
------------------------	---------------------------------------	------------------------	---

\* NOTE: See details at beginning of section for upcharge costs for this option selection.

**Specification Tips:**

- Surfaces are constructed with 1 1/8" thick high pressure laminate with 3mm Edgeband or 3mm T-Mold
- This table is available with Black glides only. Glides have 1/2" leveling range
- Overall End Table height is 20" from floor to top of 1 1/8" surface
- Overall Coffee Table height is 16" from floor to top of 1 1/8" surface
- Base available in Black, Silver or White powder coat finishes
- Bases ship fully assembled
- Optional polished aluminum foot is available for an upcharge
- Access to all standard Wilsonart®, Nevamar®, Formica® and Pionite® laminates is available

**How to Specify**

Start with base model number and **SELECT ONE CODE FROM THE OPTION** to complete your final model number for ordering:

Select MODEL NUMBER (ie., LE24D)	Option 1 [❖] EDGE	Option 2 [■] FOOT FINISH
	H3 = Edgeband (Square Corner)	P = Standard (Same Color)
	HT = T-Mold (Radiused Corner)	A = Polished Aluminum + \$42 List
Add codes to indicate options you would like:	<b>H3</b> (with Edgeband)	<b>P</b> (in Standard Color)

The final Model Number for Base Product LE24D with the highlighted options would be LE24D-H3-P (or LE24DH3P).

**Edge Options**

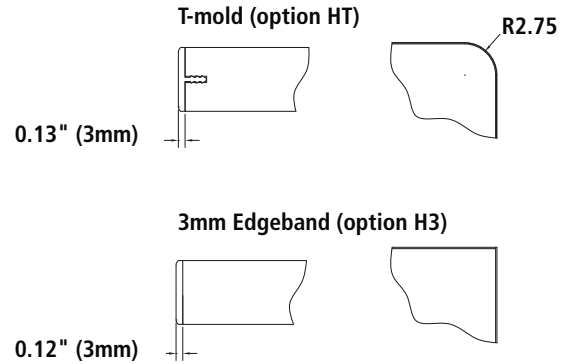

Cohere™ Tables - Occasional Tables







Model No.	Description	Wt.	List Price
<b>20" H End Tables</b>			
Option:	1	2	
LE24D	24" Round	30	755.00
LE30D	30" Round	40	816.00
LE36D	36" Round	50	901.00
LE24S	24" Square	34	755.00
LE30S	30" Square	46	816.00
LE36S	36" Square	61	901.00
<b>16" H Coffee Tables</b>			
Option:	1	2	
LC42D	42" Round	65	1,059.00
LC48D	48" Round	80	1,115.00
LC42S	42" Square	78	1,059.00
LC48S	48" Square	97	1,071.00

Office Suites  
Seating  
Tables & Desks  
Meeting Essentials  
Personal Organization  
Ergonomics  
High Density Storage  
Storage & Filing  
Facilities  
Technology Furniture  
Art & Engineering  
K-12 Education



### Specification Tips:

- Surfaces are constructed with 1 1/8" thick high pressure laminate with 3mm Edgeband or 3mm T-Mold
- This table is available with Black glides only. Glides have 1/2" leveling range
- Base available in Black, Silver or White powder coat finishes
- Optional polished aluminum foot/bridge is available for an upcharge
- Top sizes 120" and smaller come as one piece. 144" tops come in two pieces. 216" tops come in three pieces
- Y and multiple column bases require assembly
- Overall table height is 29" from floor to top of 1 1/8" work surface
- Access to all standard Wilsonart®, Nevamar®, Formica® and Pionite® laminates is available

Top Style			
			
48 x 48"	48" Dia.	72 x 36"	72 x 36"
54 x 54"	54" Dia.	84 x 42"	84 x 42"
-	60" Dia.	96 x 42"	96 x 42"
-	-	96 x 48"	96 x 48"
-	-	96 x 54"	96 x 54"
-	-	108 x 48"	108 x 48"
-	-	108 x 54"	108 x 54"
-	-	120 x 48"	120 x 48"
-	-	120 x 54"	120 x 54"
-	-	144 x 54"	144 x 54"
-	-	216 x 54"	216 x 54"

### EDGE OPTIONS

#### 3mm Edgeband (option H3)

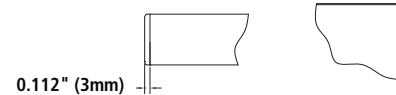

#### T-mold (option HT)

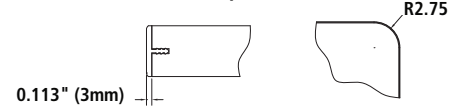

### How to Specify

Start with base model number and **SELECT ONE CODE FROM EACH OF THE OPTIONS** to complete your final model number for ordering:

Select MODEL NUMBER (ie., CX4848D)	Option 1 [❖] EDGE	Option 2 [■] CUTOUT	Option 3 [●] FOOT FINISH
	H3 = Edgeband (Square Corner)	N = No Grommet Only (No Power)	P = Standard (Same Color)
	HT = T-Mold (Radiused Corner)		B = Polished Aluminum + \$85 List

Add codes to indicate options you would like: **H3** (with Edgeband)    **N** (Without Grommet)    **P** (Same Color)

The final Model Number for Base Product CX4848D with the highlighted options would be CX4848D-H3-N-P (or CX4848DH3NP).

# Cohere™ Tables - Conference Tables

### BASE STYLES:

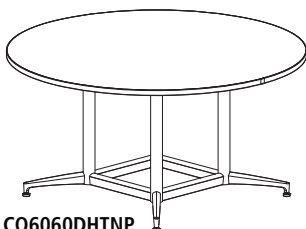
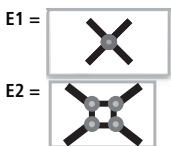

Model No.	Description	Base Style	Suggested Seating Capacity*	Wt.	List Price
<b>Single Base – Bases are included with tabletop</b> 					
<b>Option:</b>		<b>1</b>	<b>2</b>	<b>3</b>	
CX4848D	48" Round				1,450.00
CX5454D	54" Round				1,703.00
CQ6060D	60" Round				2,678.00
CQ4848S	48" Square				2,044.00
CQ5454S	54" Square				2,192.00

\* Recommended seating capacity based on 27" per chair.

Base Styles:

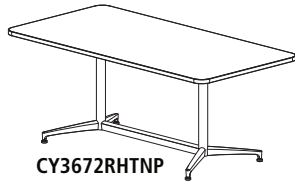
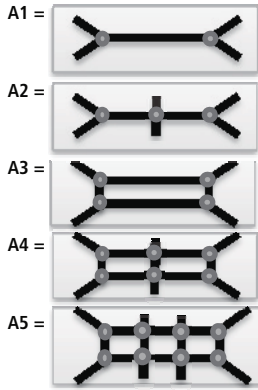

Model No.	Description	Base Style	Suggested Seating Capacity*	Wt.	List Price
<b>Y-Base Configuration – Bases are included with tabletop</b>					
<b>Option:</b>	<b>1</b>	<b>2</b>	<b>3</b>		
CY3672R		<b>N</b>		72 x 36" Rectangular	A1 6 111 1,675.00
CY3672B		<b>N</b>		72 x 36" Boat	A1 6 111 1,675.00
CY4284R		<b>N</b>		84 x 42" Rectangular	A1 8 145 2,038.00
CY4284B		<b>N</b>		84 x 42" Boat	A1 8 145 2,038.00
CY4296R		<b>N</b>		96 x 42" Rectangular	A1 8 163 2,313.00
CY4296B		<b>N</b>		96 x 42" Boat	A1 8 163 2,313.00
CY4896R		<b>N</b>		96 x 48" Rectangular	A1 8 183 2,678.00
CY4896B		<b>N</b>		96 x 48" Boat	A1 8 183 2,678.00
CY5496R		<b>N</b>		96 x 54" Rectangular	A3 8 214 3,540.00
CY5496B		<b>N</b>		96 x 54" Boat	A3 8 214 3,540.00
CY48108R		<b>N</b>		108 x 48" Rectangular	A1 10 204 2,957.00
CY48108B		<b>N</b>		108 x 48" Boat	A1 10 204 2,957.00
CY54108R		<b>N</b>		108 x 54" Rectangular	A3 10 239 3,640.00
CY54108B		<b>N</b>		108 x 54" Boat	A3 10 239 3,640.00
CY48120R		<b>N</b>		120 x 48" Rectangular	A2 10 228 3,626.00
CY48120B		<b>N</b>		120 x 48" Boat	A2 10 228 3,626.00
CY54120R		<b>N</b>		120 x 54" Rectangular	A4 10 267 4,845.00
CY54120B		<b>N</b>		120 x 54" Boat	A4 10 267 4,845.00
CY54144R		<b>N</b>		144 x 54" Rectangular	A4 10 314 5,685.00
CY54144B		<b>N</b>		144 x 54" Boat	A4 10 314 5,685.00
CY54216R		<b>N</b>		216 x 54" Rectangular	A5 14 453 8,495.00
CY54216B		<b>N</b>		216 x 54" Boat	A5 14 453 8,495.00

\* NOTE: Recommended seating capacity based on 27" per chair. Additional lead time required for 120" and larger.

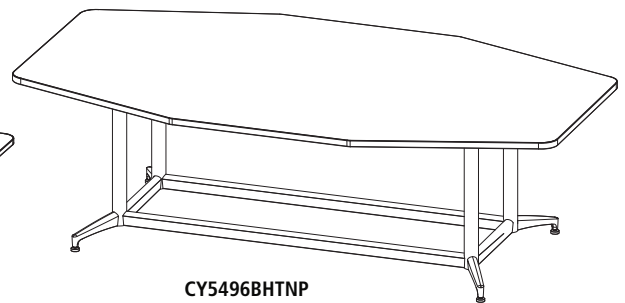
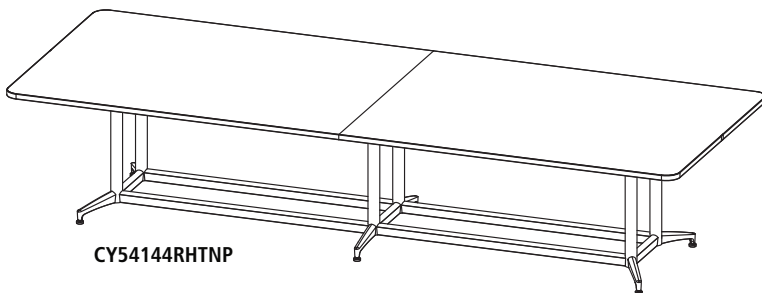

**HOW TO SPECIFY:**  
Select Model No. & Add Suffix Codes

**OPTION 1** Select EDGE Edgeband (H3) T-Mold (HT)

**OPTION 2** CUTOUT None ONLY None (N)

**OPTION 3** Select FOOT Finish Standard (P) Pol. Alum. (B)\*

\* NOTE: See details at beginning of section for upcharge costs for these option selections.

Office Suites  
Seating  
Tables & Desks  
Meeting Essentials  
Personal Organization  
Ergonomics  
High Density Storage  
Storage & Filing  
Facilities  
Technology Furniture  
Art & Engineering  
Education