

NAPOLI[®] VENEER SERIES



FAST Freight
QUICK-SHIP

The Napoli veneer desk system features Italian-influenced, sophisticated styling for business or home office. Available in two rich finishes, Napoli Furniture features AA-grade select North American hardwood veneers throughout.

Surfaces: Sierra Cherry finish on Cherry veneer, or Mahogany finish on Walnut veneer.

- Desk, Return and Extension work surfaces are 1-1/8" thick with a distinctive beveled edge.
- All veneer surfaces are protected with two coats of high-tech catalyzed lacquer.
- All models in all finishes are available on both the Quick-Ship and Fast Freight delivery programs with no quantity limitations.
- Recommended under-cabinet LED Task Light is model EZDP. Other LED Task/Desk lighting is available in the ACCESSORIES section at the end of this price list.
- All locks are keyed-alike and feature removable cores for installing "keyed-different" locks after-market.
- Silver detailing adds contemporary look to the Napoli series.

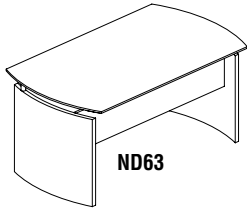
DESK



- Napoli desk surface seems to "float" on Silver supports.
- Silver modesty panel.
- Curved end panels reflect curved ends of work surface.

Model No.	Dimensions	Wt.	List Price
ND63	63"W x 36"D x 29 1/2"H	155#	\$1310
ND72	72"W x 36"D x 29 1/2"H	183#	\$1416

CURVED DESK RETURN WITH PENCIL-BOX-FILE PEDESTAL

- Creates L-shaped work surface when attached to desk.
- Available for right or left side of desk.
- Gang-lock features removable core.
- Supported by Return Pencil-Box-File Pedestal.
- Pedestal drawer interiors finished to match exterior veneer.
- Stands off floor on Silver legs.

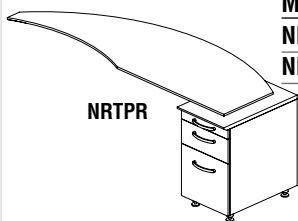

Model No.	Description	Dimensions	Wt.	List Price
NRTPR	63" Right return	63"W x 24"D x 29 1/2"H	123#	\$1324
NRTPL	63" Left return	63"W x 24"D x 29 1/2"H	123#	\$1324

CURVED DESK EXTENSION

- Creates conference end to Napoli desk.
- Leg includes grommets for cable management.
- Supported by Silver leg.
- Available for right or left side of desk.

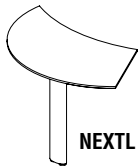

Model No.	Description	Dimensions	Wt.	List Price
NEXTR	Right extension	47"W x 28"D x 29 1/2"H	51#	\$601
NEXTL	Left extension	47"W x 28"D x 29 1/2"H	51#	\$601

CREDENZA

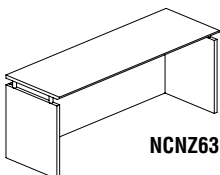

Model No.	Dimensions	Wt.	List Price
NCNZ63	63"W x 24"D x 29 1/2"H	133#	\$1135
NCNZ72	72"W x 24"D x 29 1/2"H	151#	\$1223

BRIDGE

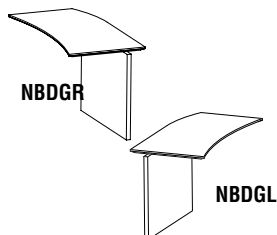

- Not free standing. Requires connection to credenza and desk.
- Features modesty panel.

Model No.	Description	Dimensions	Wt.	List Price
NBDGR	Right Hand Bridge	48"W x 24"D x 29 1/2"H	68#	\$714
NBDGL	Left Hand Bridge	48"W x 24"D x 29 1/2"H	68#	\$714

NAPOLI VENEER SERIES

HUTCH

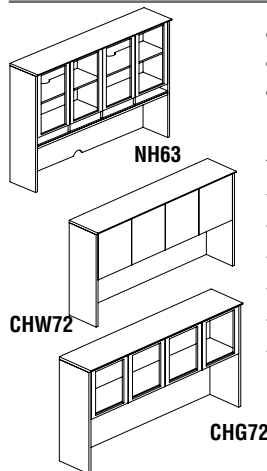

- Clear glass doors with silver frames.
- Four open compartment slots accept optional trays (See Hutch Trays).
- Provides 19 3/4"H clearance below shelf.
- Two, 12"H storage levels.
- Fully assembled.

Model No.	Dimensions	Wt.	List Price
NH63	63"W x 15"D x 50 1/2"H	183#	\$2439
NH72	72"W x 15"D x 50 1/2"H	209#	\$2584
CHW63 (with Wood Doors)	63 3/4"W x 15"D x 38 1/2"H	160#	\$1665
CHG63 (with Glass Doors)	63 3/4"W x 15"D x 38 1/2"H	160#	\$1665
CHW72 (with Wood Doors)	71 3/4"W x 15"D x 38 1/2"H	172#	\$1775
CHG72 (with Glass Doors)	71 3/4"W x 15"D x 38 1/2"H	172#	\$1775

NOTE: Recommended under-cabinet LED Task Light is model EZDP.
Other LED Task/Desk lighting is available in the ACCESSORIES section at the end of this price list.

FABRIC PANELS

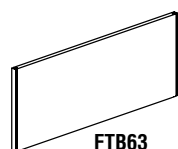

- Stocked in MIR1454 Birch Fabric.
- Other fabrics available as a special order; special orders sold in pairs.

Model No.	Dimensions	Wt.	List Price
FTB63	60"W x 18 1/2"H	15#	\$493
FTB72	69"W x 18 1/2"H	16#	\$493

HUTCH TRAYS

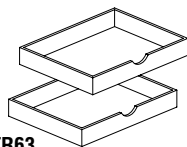

- Sold in pairs.
- Leather inlay.
- Silver.

Model No.	Description	Dimensions	Wt.	List Price
NHTR63	Hutch Trays - 63 (2)	14 5/8"W x 12 3/4"D x 2 3/8"H	7#	\$219
NHTR72	Hutch Trays - 72 (2)	15 1/8"W x 12 3/4"D x 2 3/8"H	8#	\$219

PEDESTALS

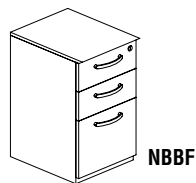

- Drawer interiors finished to match exterior veneer.
- Drawers operate smoothly using full-extension ball-bearing suspensions.
- Fits under credenzas.
- Gang-lock features removable core.
- Finished top surface.

Model No.	Dimensions	Wt.	List Price
NBBF Box-Box File	15 1/4"W x 21 1/4"D x 26"H	80#	\$903
NFF File-File	15 1/4"W x 21 1/4"D x 26"H	78#	\$860

CENTER DESK DRAWER

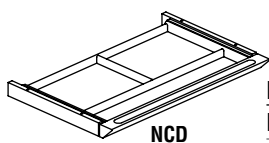

- Solid wood frame construction. Leather lined interior compartments.
- Drawer operates smoothly using full-extension ball-bearing suspension.
- Beveled front edge to match desk surface design.

Model No.	Dimensions	Wt.	List Price
NCD	30"W x 18"D x 2"H Assembled	10#	\$245

NAPOLI VENEER SERIES

MOBILE PEDESTALS

- Choice of two styles featuring two file drawers or two box drawers and one file drawer.
- File drawers accommodate letter and legal sized hanging file folders.
- Includes counter-weight for stability when in use.
- Drawers operate smoothly using full-extension ball-bearing suspensions.
- Gang-lock features removable core enabling keyed-alike suites.
- 2" dual-hooded casters. (2 lock, 2 non-lock)

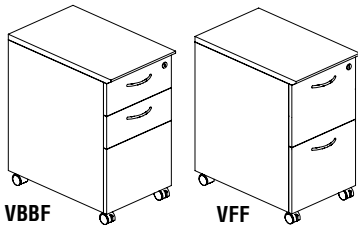

Model No.	Description	Dimensions	Wt.	List Price
VBBF	Box-Box-File	15 1/4"W x 24"D x 27 1/2"H Assembled	92#	\$897
VFF	File-File	15 1/4"W x 24"D x 27 1/2"H Assembled	80#	\$870

LATERAL FILE



- Accommodate letter and legal sized hanging file folders.
- Includes counter-weight for stability when in use.
- Gang-lock features removable core enabling keyed-alike suites.
- Drawers operate smoothly using full-extension ball-bearing suspensions.

Model No.	Description	Dimensions	Wt.	List Price
VLF	File-File	36"W x 19"D x 29 1/2"H Assembled	160#	\$1573

WARDROBE CABINETS



- Universal Door can either hinge on either right or left.
- Interior features sliding wardrobe hanging bar.
- Includes one fixed shelf and three adjustable shelves. (1 1/4" increments)

Model No.	Description	Dimensions	Wt.	List Price
VWRD	Universal Door	23 5/8"W x 19"D x 80"H	180#	\$1728

HIGH WALL CABINET WITH DOORS

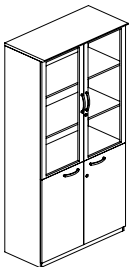

- Features glass doors with silver frame above wood doors.
- Top and bottom doors lock separately. Keyed alike.
- Includes two adjustable shelves in top section and one adjustable shelf in lower section.
- Able to stand alone or be flanked by Wardrobe Cabinets.

Model No.	Dimensions	Wt.	List Price
VHC	40"W x 19"D x 80"H	284#	\$2749

68" WALL CABINET

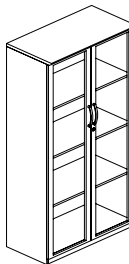

- Storage unit with choice of wood doors or glass doors.
- Includes one fixed shelf and two adjustable shelves.

Model No.	Description	Dimensions	Wt.	List Price
VCG	With glass doors	36"W x 19"D x 68"H	253#	\$1921

NAPOLI VENEER SERIES

LOW WALL CABINET WITH DOORS

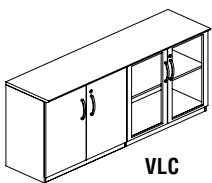

- Features a choice of wood/glass, all-wood, or all-glass door sets.
- Sets of doors lock separately. Keyed alike.
- Includes one adjustable shelf on each side.

Model No.	Description	Dimensions	Wt.	List Price
VLC	Wood/Glass Door Combination	72"W x 19"D x 29 1/2"H	193#	\$1856
VLCW	All Wood Doors	72"W x 19"D x 29 1/2"H	193#	\$1856
VLCG	All Glass Doors	72"W x 19"D x 29 1/2"H	193#	\$1856

BOOKCASES

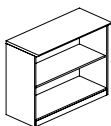

- Open shelves for convenient storage.
- Adjustable shelves.
- VB2 & VB5 support 75 lbs. per shelf, evenly distributed; VBQ2 supports 25 lbs. per shelf, evenly distributed.
- Choice of two or five shelf units.
- 1" thick shelves.

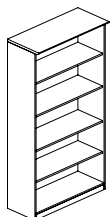

Model No.	Description	Dimensions	Wt.	List Price
VB2	2 Shelf	36"W x 16"D x 29 1/2"H	64#	\$764
VB5	5 Shelf	36"W x 16"D x 68"H	140#	\$1480
VBQ2	2 Shelf 1/4 - Round	19"W x 19"D x 29 1/2"H	25#	\$718

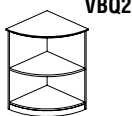

NAPOLI RECEPTION FURNITURE

First impressions are critical for any business. The Napoli Reception Furniture is available in two finishes, and features AA-grade North American hardwood veneers throughout.

Surfaces: Sierra Cherry finish on Cherry veneer and Mahogany finish on Walnut veneer.

- All Napoli Reception Stations (except NRS) include a center drawer.
- Non-handed return.
- 3/4" frosted, tempered glass.
- Universal ADA Reception Return can only be used with Napoli Reception Station.

Model No.	Description	Dimensions	Wt.	List Price
NRS	Reception Station (no peds)	87 1/4"W x 37 1/4"D x 42 3/4"H	398#	\$3228
NRSBF	Reception Station with B/B/F, F/F	87 1/4"W x 37 1/4"D x 42 3/4"H	577#	\$5150
NRSBB	Reception Station with 2-B/B/F	87 1/4"W x 37 1/4"D x 42 3/4"H	562#	\$5179
NRSLBF	Reception Station with B/B/F, F/F	87 1/4"W x 37 1/4"D x 42 3/4"H Desk 48"W x 25"D x 39 1/4"H Return	980#	\$6752
NRSLBB	Reception Station with 2-B/B/F	87 1/4"W x 37 1/4"D x 42 3/4"H Desk 48"W x 25"D x 39 1/4"H Return	980#	\$6764
NRSLFF	Reception Station with 2-F/F	87 1/4"W x 37 1/4"D x 42 3/4"H Desk 48"W x 25"D x 39 1/4"H Return	980#	\$6723
NRSLBA	Reception Station with 1-B/B/F Universal ADA Return	87 1/4"W x 37 1/4"D x 42 3/4"H Desk 38"W x 20 1/2"D x 28 3/4"H Return	553#	\$4803
NRTNA	Universal ADA Return	38"W x 20 1/2"D x 28 3/4"H	64#	\$477

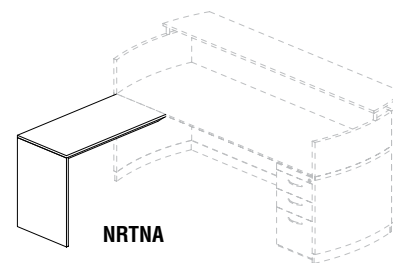
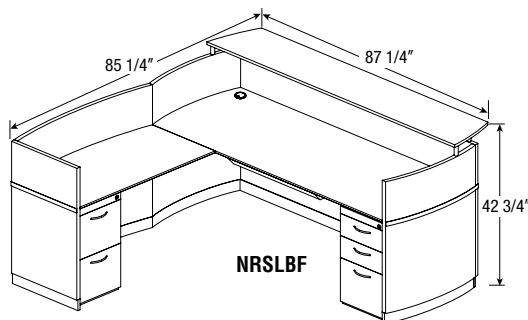
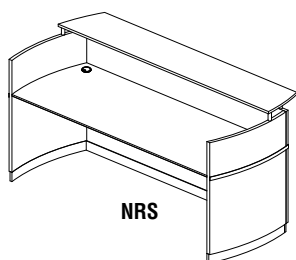

NAPOLI VENEER SERIES

NAPOLI CONFERENCE TABLES

The Napoli veneer conference room furniture features elegant lines with excellent durability. Available in two rich finishes, Napoli features AA-grade select North American hardwood veneers throughout.

Surfaces: Sierra Cherry finish on cherry veneer and Mahogany finish on walnut veneer.

- All veneer surfaces are protected with two coats of high-tech catalyzed lacquer.
- Grommet hole cutout size is 2 3/4" x 6".

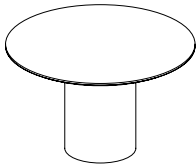

NCR48

Model No.	Description	Dimensions	Wt.	List Price
NC6	6' Conference Table	72"W x 36"D x 29 1/2"H	197#	\$1832
NC8	8' Conference Table	96"W x 42"D x 29 1/2"H	236#	\$2278
NC10	10' Conference Table	120"W x 48"D x 29 1/2"H	306#	\$3224
NC12	12' Conference Table	144"W x 54"D x 29 1/2"H	358#	\$5256
NC14	14' Conference Table	168"W x 54"D x 29 1/2"H	399#	\$5502
NC18	18' Conference Table	216"W x 54"D x 29 1/2"H	545#	\$7853
NC20	20' Conference Table	240"W x 54"D x 29 1/2"H	585#	\$8098
NC24	24' Conference Table	288"W x 54"D x 29 1/2"H	732#	\$10450
NC26	26' Conference Table	312"W x 54"D x 29 1/2"H	772#	\$10694
NC30	30' Conference Table	360"W x 54"D x 29 1/2"H	919#	\$13047
NCR48	Round Conference Table	48" Round x 29 1/2"H	135#	\$1514
CTMB	Presentation Board	48" x 48" x 3 1/4"	110#	\$1467

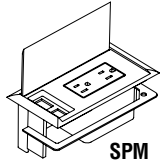
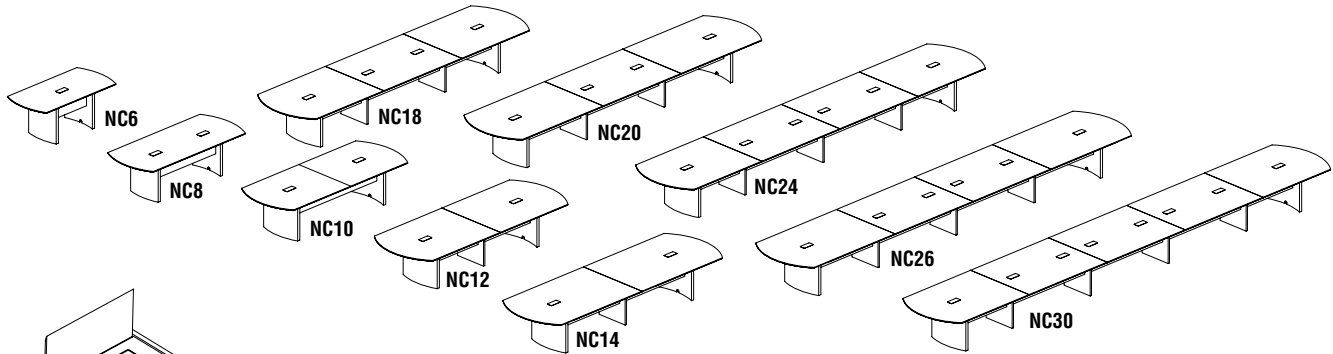

SPM

Model No.	Description	List Price
SPM 	6 1/4"W x 4"D x 1 1/2"H Optional Power Module, UL Listed [includes RJ11-Cat 3 coupler (phone) and RJ45 coupler (data)] – 6' power cord. Black only.	\$298

BUFFET

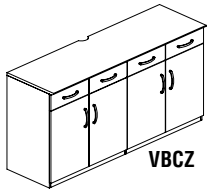

VBCZ

- Features two cabinet compartments (one adjustable shelf in each) and four drawers.
- Designed for audio/visual support including cable pass throughs and inset back panel for wall plug clearance.
- All drawer and cabinet interiors are full-finished veneer.

Model No.	Dimensions	Wt.	List Price
VBCZ	72"W x 22"D x 36"H	297#	\$2972

REPLACEMENT LOCK CORES

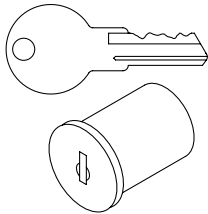

- Allows pedestals and laterals to be keyed uniquely for up to 15 different workstations.
- Master key available.
- Must purchase a core removal tool to change locks cores.

Model No.	Description	Wt.	List Price
REALCC0311 through REALCC0325 (Silver)	Replacement core with keys	1#	\$22
REALCRK	Core removal tool	1#	\$22
REALCMK	Master Key	1#	\$22