

DRAFTING FURNITURE



Ranger® Drawing Tables
Ranger® Team Tables
Futur Matic® Drawing Tables
Prokits
Straightedges
Vertical Hanging Files
Plan Files

WORKSPACES

DESKS &
STORAGE

TABLES

SEATING

HIGH DENSITY
STORAGE

MAIL ROOM
FURNITURE

TECHNOLOGY
FURNITURE

**DRAFTING
FURNITURE**

ACCESSORIES

PRODUCT
INDEX

DRAWING TABLES



Mayline's original flagship products set the standard more than 70 years ago - a unique product family bringing our drafting heritage into today's modern workplace.

RANGER® STEEL 4-POST & SPLIT-TOP

Drawing Boards: Thermally fused 1" thick Tables woodgrain low-pressure laminate surface with steel end cleats only, six top sizes.

Top Height: 37" from floor.

Tilt Angle: 50° from horizontal.

Available Options:

Tool Drawer: Comes with insert tray and lock with two keys.

Shallow Plan Drawer: Convenient storage for papers and reference materials. Not available with the split-top table.

Table is shipped knocked down.

Drawer Dimensions:

Tool Drawer

Shallow Drawer

Table 7734B

Table 7736B

All other tables

Height	Width	Depth
3 3/8"	10 3/8"	27 3/8"
1 5/8"	24 1/4"	27 3/8"
1 5/8"	36 1/4"	27 3/8"
1 5/8"	48 1/4"	27 3/8"

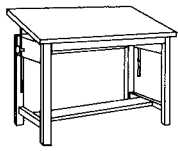

Model No.	Description	Wt.	List Price
Ranger Steel 4-Post Table only. No drawers.			
7732	30" x 42"	108#	\$1343
7734	37 1/2" x 48"	118#	\$1441
7736	37 1/2" x 60"	157#	\$1518
7737	37 1/2" x 72"	167#	\$1839
7738	43 1/2" x 72"	177#	\$2017
7739	43 1/2" x 84"	185#	\$2241

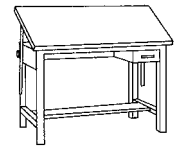

Model No.	Description	Wt.	List Price
Ranger Steel 4-Post A Combination Table with tool drawer only.			
7732A	30" x 42"	134#	\$1563
7734A	37 1/2" x 48"	146#	\$1676
7736A	37 1/2" x 60"	160#	\$1718
7737A	37 1/2" x 72"	177#	\$1897
7738A	43 1/2" x 72"	187#	\$2158
7739A	43 1/2" x 84"	195#	\$2321

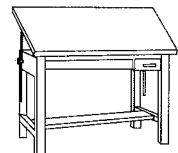

Model No.	Description	Wt.	List Price
Ranger Steel 4-Post B Combination Table with tool and shallow drawers.			
7734B	37 1/2" x 48"	156#	\$1822
7736B	37 1/2" x 60"	172#	\$1934
7737B	37 1/2" x 72"	194#	\$2080
7738B	43 1/2" x 72"	204#	\$2354
7739B	43 1/2" x 84"	212#	\$2569

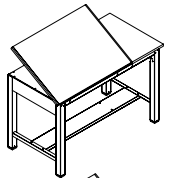

Ranger Split-Top

 Table only. No drawers.

Model No.	Overall	Tilt Surface	Fixed Surface	Wt.	List Price
7772	30" x 60"	42"W	18"W	150#	\$2186
7773	30" x 72"	48"W	24"W	160#	\$2374

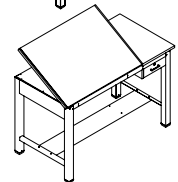

Ranger Split-Top A Combination.

 Table with tool drawer only.

Model No.	Overall	Tilt Surface	Fixed Surface	Wt.	List Price
7772A	30" x 60"	42"W	18"W	155#	\$2567
7773A	30" x 72"	48"W	24"W	165#	\$2757

RANGER® SPLIT TOP PROJECT TABLE

The perfect design solution with an angled and horizontal worksurface all-in-one project table. With LPL and HPL laminate choices and a large horizontal surface to accommodate a laptop and/or keyboard the Mayline® Ranger® Split Top Project Table is a unique product bringing together Mayline's drafting heritage into a modern workplace.

- Available in a 60" width and 31" depth.
- Available in low pressure (no suffix) and high pressure (L suffix) on the tilt surface.
- Tilt surface ships with steel end cleats and pencil/marker stop.
- Tilt surface ships with steel end cleats and pencil/marker ledge.
- Tilt angle 50° from horizontal.
- Grommet standard and centered on rear horizontal surface worksurface.
- Table legs contain adjustable leveling glides.
- Optional Caster Kit available (order as part #350221) providing 4 casters (2 locking and 2 non-locking).
- Optional tool drawer, or tool and shallow plan drawer combination for storage.
- Tool drawer comes with insert tray and lock with two keys.
- Tool drawer dimensions: 3 3/8"H x 10 3/8"W x 27 3/8"D.
- Shallow plan drawer convenient for storage of papers and reference materials.
- Shallow plan drawer dimensions: 1 5/8"H x 36 1/4"W x 27 3/8"D.
- Top height approximately 37" from floor.
- Ships knocked down, assembly required.
- Over 900+ HPL laminates on horizontal and tilt surfaces, including dry erase options.

Model No.	Overall	Tilt Surface	Fixed Surface	Wt.	List Price
Split Top Project Table Table only. No drawers.					
7774	31" x 59"	31" x 30"	30" x 29"	159#	\$2201
7774L	31" x 59"	31" x 30" HPL	30" x 29" HPL	159#	\$2331
Split Top Project Table Table with tool drawer only.					
7774A	31" x 59"	31" x 30"	30" x 29"	164#	\$2571
7774LA	31" x 59"	31" x 30" HPL	30" x 29" HPL	164#	\$2709
Split Top Project Table Table with tool and shallow drawers.					
7774B	31" x 59"	31" x 30"	30" x 29"	168#	\$2686
7774LB	31" x 59"	31" x 30" HPL	30" x 29" HPL	168#	\$2909

Note: Weights listed are only estimates.

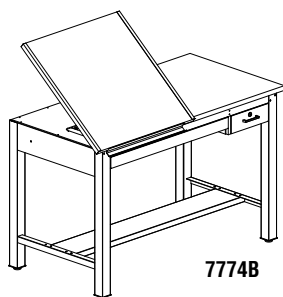

7774B

RANGER® TEAM TABLES

GIZA/CAP

Mayline's Ranger Team Table is the perfect solution for project or other team meetings. The Team Table has the same great strength and quality as our standard Ranger drafting table which is the result of years of experience in the drafting industry. A variety of storage under the standing height table can house project or meeting materials.

- Rectangular shape 36"D x 96"W x 42"H.
- Heavy-duty steel base provides strength and stability and is available as standard in Mayline Corporate colors.
- High pressure laminate top with 3mm edge banding.
- All Mayline Corporate color HPLs available from Wilsonart, Nevamar, Pionite and Formica.
- Custom colors for storage or table elements available upon request with an extended lead time. Please call Customer Service for a quotation.

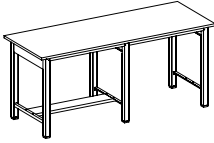

Model No.	Description	Wt.	List Price
7760	36"D x 96"W x 42"H Ranger Base Standing Height Table Interior Frame Dimensions 23"D x 41 1/4"W per Leg Section (85 1/2"W overall) x 39"H	170#	\$2306

The Ranger Team Table can be used with Mayline® Plan Files, Lateral Files and Bookcases to store a variety of team and project materials. Refer to interior table dimensions to verify how many units will fit beneath the table. Please contact Customer Service 1-800-822-8037 with questions.

RANGER® TEAM TYPICALS

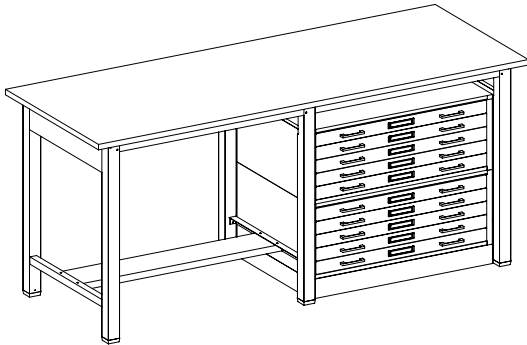

RANGER TEAM TYPICAL #1 – Any combination of Interlocking Files can be used, 5-Drawer and 10-Drawer models as seen in this Price List page 383.

Consists of:			
QTY.	MODEL NO.	DESCRIPTION	LIST PRICE EACH
1	7760	Team Table	\$2306
1	7767U	Steel Cap	\$562
1	7767W	Flush Base	\$387
2	7767	5-Drawer Files	\$2431

RTT1

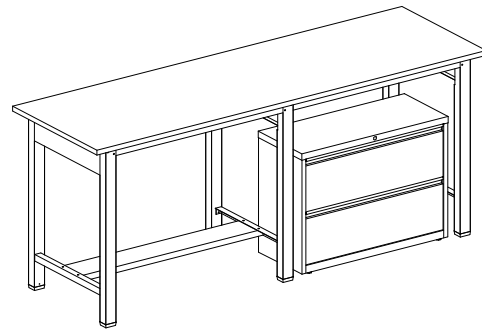
TOTAL: **\$8007**

RANGER TEAM TYPICAL #2 – (Note: Back-to-back laterals would extend beyond the leg structure of the table.)

Consists of:			
QTY.	MODEL NO.	DESCRIPTION	LIST PRICE EACH
1	7760	Team Table	\$2306
1	HLT362	Lateral File	\$878

RTT2

TOTAL: **\$3184**

ECONOMY RANGER® STEEL 4-POST

Drawing Board: Thermally-fused laminate surface, two top sizes.

Top Height: 37" from floor.

Tilt Angle: 50° from horizontal.

Available Options: Tool Drawer, Shallow Plan Drawer (locks not available).

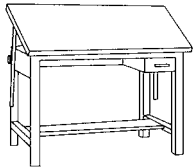

Model No.	Description	Wt.	List Price
Economy Ranger Steel 4-Post Table only. No drawers.			
7724	38 1/2" x 48"	110#	\$1320
7726	38 1/2" x 60"	150#	\$1345

Economy Ranger Steel 4-Post A Combination Table with tool drawer only.

7724A	38 1/2" x 48"	138#	\$1573
7726A	38 1/2" x 60"	152#	\$1609

Economy Ranger Steel 4-Post B Combination Table with tool and shallow drawers.

7724B	38 1/2" x 48"	148#	\$1676
7726B	38 1/2" x 60"	160#	\$1722

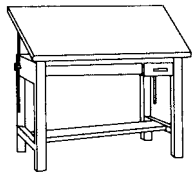

WOOD 4-POST

Drawing Tops: Thermally-fused laminate surface, two top sizes. end cleats; two top sizes.

Top Height: 37" from floor.

Tilt Angle: 50° from horizontal.

Available Options:

Tool Drawer: Equipped with removable insert tray, individual lock with two keys.

Shallow Plan Drawer: Storage drawer for papers and reference materials.

Drawer Dimensions:	Height	Width	Depth
Tool Drawer	3 3/4"	10 3/4"	25"
Shallow Plan Drawer	1 7/8"	46"	25"

Table is shipped knocked down.

- 200 lb. weight capacity
- Drawer interiors are finished.

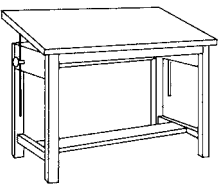

Model No.	Description	Wt.	List Price
Wood 4-Post only. No drawers.			
7706	37 1/2" x 60"	137#	\$2879
7707	37 1/2" x 72"	154#	\$3105

Finishes: Standard - Naturalist, Golden Oak, or Unfinished

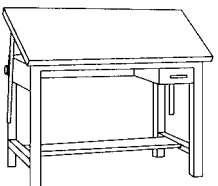

Wood 4-Post A Combination with tool drawer.

7706A	37 1/2" x 60"	147#	\$3194
7707A	37 1/2" x 72"	164#	\$3419

Finishes: Standard - Naturalist, Golden Oak, or Unfinished

Wood 4-Post B Combination with tool and shallow drawers.

7706B	37 1/2" x 60"	160#	\$3354
7707B	37 1/2" x 72"	172#	\$3598

Finishes: Standard - Naturalist, Golden Oak, or Unfinished

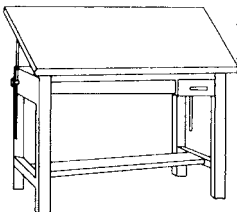

FUTUR-MATIC® DRAWING TABLES

Drawing Boards: Thermally-fused laminate surface, two top sizes.

Top Height Range: 18" travel range, 30" to 48" adjustment.

Tilt Angle: Horizontal tilt to 89°.

Electrical System: 110V, 60 Hz, 24V DC motor. Draws 1.2 amps under full load.

FM T/C Drive System: 250 pounds of lifting capacity and 150 foot pounds of tilting torque. All gear drive. No belts or pulleys.

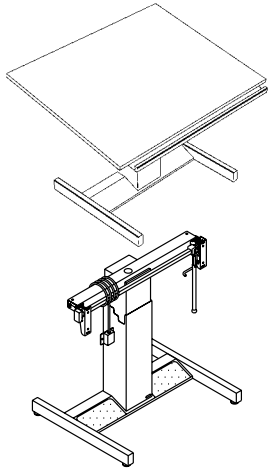

Model No.	Description	Wt.	List Price
Futur-Matic with electric height and manual tilt adjustment.			
8693B	30" x 42"	160#	\$5590
8694B	37 1/2" x 48"	180#	\$5997
8696B	37 1/2" x 60"	190#	\$6141
8697B	37 1/2" x 72"	242#	\$6305
Power Bases with 29" - 47" height adjustment. Power height. Manual tilt.			
81370A6	(without board brackets)	104#	\$4517
3117	Board brackets for 81370A6	10#	\$162

Board brackets sold separately. Required for addition of all work surfaces.

NOTE: Mounting hole patterns for digitizer tablets vary from manufacturer to manufacturer and require different brackets. Please contact your digitizer tablet dealer or manufacturer first to obtain this information before ordering.

LIGHT TABLES

Drawing Boards: Self-contained light box with translucent 1/8" acrylic diffuser panel, 1/4" clear glass and hardwood frame with Naturalist finish.

Dimming Control Range: 0 - 325 foot candles, with solid state, full-range dimming control.

Lighting: 30" x 36" Four 30W Tubes (supplied) or 30" x 48" Four 40W Tubes (supplied). All tubes must be cool white rapid-start only.

Electrical Requirements: 120V, 60 Hz, 2.0 Amps.

Model No.	Top Size	Glass Size	Wt.	List Price
Ranger Steel 4-Post Light Tables with tool and shallow drawer units.				
7734BLT	37 1/2" x 48"	30" x 36"	250#	\$7063
7736BLT	37 1/2" x 60"	30" x 48"	256#	\$7462
Colors: Standard - White, Desert Sage, Gray				
Replacement Light Tops				
20627R3	37 1/2" x 48"	30" x 36"	126#	\$5426
20628R3	37 1/2" x 60"	30" x 48"	146#	\$5817

Note: Glass used is 1/4" thick clear with swiped edges. When purchasing light tops separately, specify what type table is being used so proper hardware is supplied.

Finishes: Standard - Naturalist

PROKITS

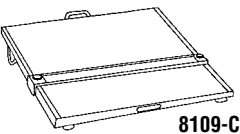

8109-C

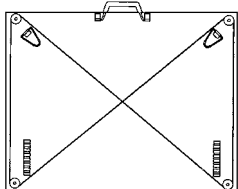

Model No.	Description	Wt.	List Price
PROFESSIONAL DRAWING KITS (PROKITS)			
Woodgrain Low-Pressure Laminate with Transparent Edge Kit Rule			
8111C	15" x 20"	8#	\$332
8109C	18" x 24"	12#	\$342
8115C	30" x 42"	31#	\$495

STRAIGHTEDGES

MAYLINE® STRAIGHTEDGE SPECIFICATIONS

Delrin® rollers best for Mylar sheets or Steel rollers for vellum and other paper medium.

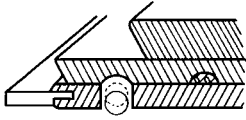

Model No.	Length		Wt.	List Price
Mobile Parallel Ruling Straightedge with E-Z Grip Cap with Steel Rollers				
7271A	36"		2.6#	\$386
7272A	42"	Above-board	2.9#	\$404
7273A	48"	mounting hardware included	3.3#	\$460
7275A	60"		4.1#	\$605

Model No.	Length		Wt.	List Price
Mobile Parallel Ruling Straightedge with E-Z Grip Cap & Armoredge® with Steel Rollers				
7271ASE	36"		2.5#	\$502
7272ASE	42"	Above-board	2.9#	\$534
7273ASE	48"	mounting hardware included	3.3#	\$602
7275ASE	60"		4.1#	\$801

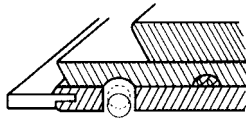

Model No.	Length		Wt.	List Price
Mobile Parallel Ruling Straightedge with E-Z Grip Cap with Delrin® Rollers				
D7270A	30"		2.3#	\$380
D7271A	36"		2.6#	\$397
D7272A	42"	Above-board	2.9#	\$413
D7273A	48"	mounting hardware included	3.3#	\$463
D7275A	60"		4.1#	\$610

Model No.	Length		Wt.	List Price
Mobile Parallel Ruling Straightedge with E-Z Grip Cap & Armoredge® with Delrin® Rollers				
D7271ASE	36"		2.5#	\$525
D7272ASE	42"	Above-board	2.9#	\$540
D7273ASE	48"	mounting hardware included	3.3#	\$561
D7275ASE	60"		4.1#	\$770

Model No.	Length		Wt.	List Price
Mobile Parallel Ruling Straightedge with Steel Rollers				
7260A	30"		1.9#	\$281
7261A	36"		2.1#	\$297
7262A	42"	Above-board	2.4#	\$312
7263A	48"	mounting hardware included	2.7#	\$332
7265A	60"		3.3#	\$432

MAYLINE STRAIGHTEDGE SPECIFICATIONS

Model No.	Length		Wt.	List Price
Mobile Parallel Ruling Straightedge with Armoredge® with Steel Rollers				
7261ASE	36"		2.2#	\$440
7262ASE	42"		2.4#	\$459
7263ASE	48"	Above-board mounting hardware included	2.8#	\$475
7265ASE	60"		3.4#	\$576

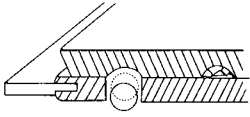

Mobile Parallel Ruling Straightedge with Delrin® Rollers				
D7260A	30"		1.9#	\$272
D7261A	36"		2.1#	\$291
D7262A	42"	Above-board mounting hardware included	2.4#	\$308
D7263A	48"		2.8#	\$324
D7265A	60"		3.4#	\$391

Mobile Parallel Ruling Straightedge with Armoredge® with Delrin® Rollers				
D7261ASE	36"		2.2#	\$453
D7262ASE	42"		2.4#	\$466
D7263ASE	48"	Above-board mounting hardware included	2.8#	\$484
D7265ASE	60"		3.4#	\$568

E-Z Grip Parallel Ruling Straightedge				
7250A	30"		1.7#	\$264
7251A	36"		2.0#	\$281
7252A	42"	Above-board mounting hardware included	2.3#	\$297
7253A	48"		2.6#	\$312
7255A	60"		3.1#	\$413

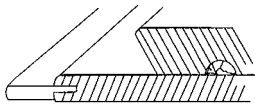

E-Z Grip Parallel Ruling Straightedge with Armoredge®				
7251ASE	36"		2.0#	\$411
7252ASE	42"		2.3#	\$431
7253ASE	48"	Above-board mounting hardware included	2.6#	\$442
7255ASE	60"		3.1#	\$562

Conversion Kit				
7302D	Conversion Kit – includes complete hardware and mounting attachments to convert any size above-board straightedge to underboard.		1.0#	\$172

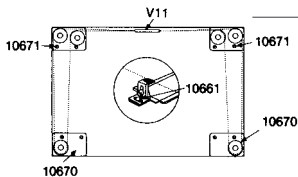

DRAWING ACCESSORIES

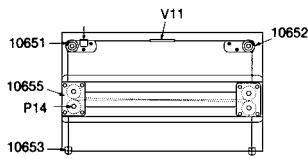

The numbers indicated in the illustration are for part identification only.

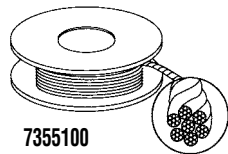

7355100

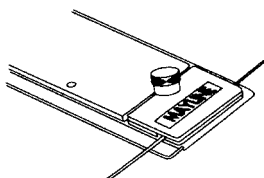
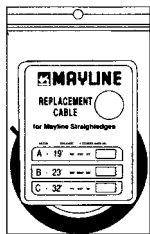

Model No.	Length	Wt.	List Price
E-Z Grip Blade Only with Armoredge®			
7251SE	36"	1.8#	\$288
7252SE	42"	2.1#	\$307
7253SE	48"	2.4#	\$345
7255SE	60"	3.0#	\$412

Underboard Attachment

7302A	30" to 42"	0.6#	\$124
7302B	48" to 72"	0.6#	\$131
7302C	84" to 96"	0.6#	\$135

Above Board Attachment Only

7301A	30" to 42"	0.4#	\$102
7301B	48" to 72"	0.4#	\$108
7301C	84" to 96"	0.4#	\$117

Hardware Bags

7306	Replacement hardware bag for above-board straightedge (Edgemount)	0.5#	\$47
7307	Hardware for mold edge surfaces	1.0#	\$112
7308	Hardware bag for above-board straightedge (Surface Mount)	1.0#	\$47

7 x 7 Lubricated Stainless Steel Cable with Nylon Coating

7355100	100' Spool	0.5#	\$98
7355300	300' Spool	0.8#	\$263
7355A	Replacement Cable for 30" - 42" straightedge, 19 feet	0.1#	\$32
7355B	Replacement Cable for 48" - 60" straightedge, 23 feet	0.1#	\$43
7355C	Replacement Cable for 72" - 96" straightedge, 32 feet	0.1#	\$57

Cut to length coils. Save time in measuring, cutting, and coiling. Pre-packed.

Note: For all types of parallel ruling attachments. Braided wire is corrosion resistant. Outside diameter .035".

Model No.	Description	Wt.	List Price
-----------	-------------	-----	------------

Straightedge Brake

7305	Parallel Ruling Straightedge Brake for all Mayline® above-board blades; 2 brakes per package.	0.1#	\$55
------	---	------	------

One slight twist of the knob locks the straightedge into position enabling complete freedom of hands for use of lettering sets or inking. Also prevents loss of position due to bumping or adjusting table.

Note: Standard on all new above-board straightedges.

Touch Up Paint

9552	Must specify color, some not available.	1#	\$31
------	---	----	------

Touch up paint matched for all Mayline® metal finishes. Available in 12 oz. pressurized spray cans. Ground shipment only.

Drawing Vinyl

9501V	24" x 30"	4#	\$86
9511V	30" x 36"	45#	\$107
9503V	30" x 42"	5#	\$113
9504V	37 1/2" x 48"	10#	\$175
9506V	37 1/2" x 60"	15#	\$201
9507V	37 1/2" x 72"	18#	\$241

Color: Green on one side, Off-White other side. For clear vinyl, add C suffix.

When ordering drawing vinyl with tables, we will apply it to your table top with double faced tape along the top edge only for an additional \$100 list. Never cement vinyl to your drawing top. May cause warpage or damage.

VERTICAL HANGING FILES

Ideal choice for economical, mobile filing of active documents.

Rolling Stands: Constructed of tubular steel finished with an electrostatically applied high solid polyester paint. Front locking casters.

Clamps: Spring-loaded metal mounting clips with metal wing knobs. Hold up to 100 sheets. Includes plastic ID holders and cards.

Hangers: Metal pivot hangers for easy removal of clamps.

Model No.

Vertical File Rolling Stand Complete (Adjusts: 45 1/4" - 60"H and 28 1/2" - 42 1/2"D)

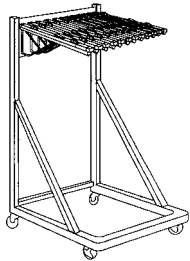

	Max. Filing Width	Description	Wt.	List Price
9321	18"	Rolling stand with 12 hangers and clamps	63#	\$1575
9322	24"	Rolling stand with 12 hangers and clamps	66#	\$1643
9323	30"	Rolling stand with 12 hangers and clamps	69#	\$1716
9324	36"	Rolling stand with 12 hangers and clamps	71#	\$1855
9325	42"	Rolling stand with 12 hangers and clamps	75#	\$1946
9329	-	Rolling stand only; Height adjusts from 45 1/4" to 60"H. Depth adjusts from 28 1/2" to 42 1/2". Width is 26 3/4".	39#	\$749
9329H	-	Rolling stand with hangers (no clamps)	51#	\$1038

Color: Standard - Sand Beige

Vertical File Wall Rack Complete

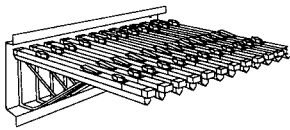

	Max. Filing Width	Description	Wt.	List Price
9301	18"	Wall rack with 12 hangers and clamps	46#	\$1002
9302	24"	Wall rack with 12 hangers and clamps	48#	\$1077
9303	30"	Wall rack with 12 hangers and clamps	50#	\$1147
9304	36"	Wall rack with 12 hangers and clamps	54#	\$1284
9305	42"	Wall rack with 12 hangers and clamps	58#	\$1372
9309	-	Wall rack only; 10 1/4"H x 23 1/8"L	6.5#	\$109
9309H	-	Wall rack with 12 hangers (no clamps)	18.5#	\$455

Color: Standard - Sand Beige

Expandable Mobile Plan Center - Adjustable vertical file cart

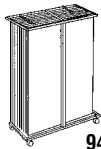

9429

	Max. Filing Width	Description	Wt.	List Price
9429	27" - 39"	Expandable file cart, 40"-52" H x 16" D 1200 sheet, 12 clamp capacity	25#	\$806

Note: Accepts clamps of 24", 30", and 36" length. (not included)

Color: Standard - Sand Beige

Vertical File End Resting Wall Rack Complete

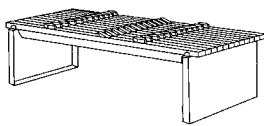

	Max. Filing Width	Description	Wt.	List Price
9311	18"	Wall rack with 12 clamps	18#	\$635
9312	24"	Wall rack with 12 clamps	22#	\$705
9313	30"	Wall rack with 12 clamps	24#	\$782
9314	36"	Wall rack with 12 clamps	28#	\$920
9315	42"	Wall rack with 12 clamps	32#	\$1011
9319	-	Wall rack only for End Resting Clamps 8"H x 15"L	6#	\$110

Color: Standard - Sand Beige

Clamps Only	Size	Qty.	Wt.	List Price
93316	18"	6/ctn.	6#	\$264
93326	24"	6/ctn.	8#	\$301
93336	30"	6/ctn.	9#	\$332
93346	36"	6/ctn.	10#	\$402
93356	42"	6/ctn.	12#	\$444

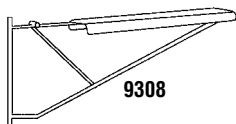
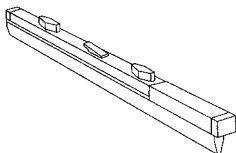

9308

Hangers Only	Description	Wt.	List Price
9308	For clamps 9331 - 9335 packed 12 per carton	12#	\$382

Vertical File Parts	Description	Wt.	List Price
10550	Knobs, 12 per package	.50#	\$61
10551	Springs, 12 per package	.50#	\$31
10552	T-Bolts, 12 per package	.50#	\$44
10553	Labels and Holders, 12 per package	1#	\$35

PLAN FILES



WORKSPACES
 DESKS & STORAGE
 TABLES
 SEATING
 HIGH DENSITY STORAGE
 MAIL ROOM FURNITURE
 TECHNOLOGY FURNITURE
 DRAFTING FURNITURE
 ACCESSORIES
 PRODUCT INDEX

C-FILES® (NOTE: Not on GSA)

Self-contained steel C-Files® have integral cap and can be bolted together for stacking. Drawers have front metal plan depressor and rear hood to keep documents flat and orderly. High base designed to support one file. Drawer pulls are chrome. Files stack five high on flush base. Files stack two high on base legs.

File physical paper capacity: 1000 sheets vellum per file.
 100 sheets vellum per drawer in a 10 drawer file.
 200 sheets vellum per drawer in a 5 drawer file.

File weight capacity: 20 lbs. (9.1 kg) per drawer in a 10 drawer file evenly distributed.
 40 lbs. (18.2 kg) per drawer in a 5 drawer file evenly distributed.

Model No.

Mayline® Self-Contained Steel C-Files®

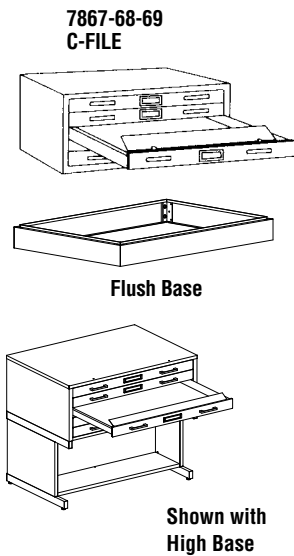

For 24" x 36" Sheets

		Overall Unit Sizes			Inside Drawer Sizes			Wt.	List Price
		W	H	D	W	H	D		
7867C	Five-Drawer File	40 3/4"	15 3/8"	28 3/8"	37"	2"	25 3/4"	170#	\$1970
7867D	Five-Drawer with Dust Cover	40 3/4"	15 3/8"	28 3/8"	37"	2"	25 3/4"	177#	\$2188
7977C	Ten-Drawer File	40 3/4"	15 3/8"	28 3/8"	37"	5/8"	25 3/4"	210#	\$4158
7977D	Ten-Drawer with Dust Covers	40 3/4"	15 3/8"	28 3/8"	37"	5/8"	25 3/4"	216#	\$4696
7877	20" High Base with Bookshelf	40 3/4"	20"	28 3/8"	33 3/4"	-	14 1/2"	52#	\$792
7867W	Flush Base	40 3/4"	4"	28 3/8"	-	-	-	14#	\$343
7890X	Base Legs	41"	6"	28 5/8"	-	-	-	15#	\$332
7890Y	Base Legs	41"	19 3/8"	28 5/8"	-	-	-	45#	\$711

For 30" x 42" Sheets

		Overall Unit Sizes			Inside Drawer Sizes			Wt.	List Price
		W	H	D	W	H	D		
7868C	Five-Drawer File	46 3/4"	15 3/8"	35 3/8"	43"	2"	32 3/4"	220#	\$2290
7868D	Five-Drawer File with Dust Covers	46 3/4"	15 3/8"	35 3/8"	43"	2"	32 3/4"	229#	\$2508
7978C	Ten-Drawer File	46 3/4"	15 3/8"	35 3/8"	43"	5/8"	32 3/4"	305#	\$4333
7978D	Ten-Drawer with Dust Covers	46 3/4"	15 3/8"	35 3/8"	43"	5/8"	32 3/4"	310#	\$4907
7878	20" High Base with Bookshelf	46 3/4"	20"	35 3/8"	44 3/4"	-	14 1/2"	63#	\$896
7868W	Flush Base	46 3/4"	4"	35 3/8"	-	-	-	16#	\$381
7890X	Base Legs	47"	6"	35 5/8"	-	-	-	15#	\$332
7890Y	Base Legs	47"	19 3/8"	35 5/8"	-	-	-	45#	\$711

For 36" x 48" Sheets

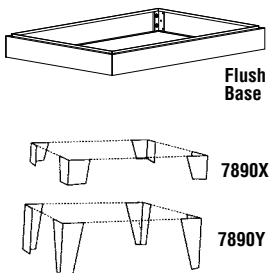

		Overall Unit Sizes			Inside Drawer Sizes			Wt.	List Price
		W	H	D	W	H	D		
7869C	Five-Drawer File	53 3/4"	15 3/8"	41 3/8"	50"	2"	38 3/4"	275#	\$2731
7869D	Five-Drawer File with Dust Covers	53 3/4"	15 3/8"	41 3/8"	50"	2"	38 3/4"	279#	\$2951
7979C	Ten-Drawer File	53 3/4"	15 3/8"	41 3/8"	50"	5/8"	38 3/4"	365#	\$5156
7979D	Ten-Drawer with Dust Covers	53 3/4"	15 3/8"	41 3/8"	50"	5/8"	38 3/4"	350#	\$5861
7879	20" High Base with Bookshelf	53 3/4"	20"	41 3/8"	51 3/4"	-	14 1/2"	70#	\$988
7869W	Flush Base	53 3/4"	4"	41 3/8"	-	-	-	18#	\$459
7890X	Base Legs	54"	6"	41 5/8"	-	-	-	15#	\$332
7890Y	Base Legs	54"	19 3/8"	41 5/8"	-	-	-	45#	\$711

HAMILTON UNIT SYSTEM™ FILES SPECIFICATIONS

Interlocking steel plan files are designed for ease of stacking. Capacity of drawers may be increased by using Model No. 7965 and 7966 magnetic drawer dividers to arrange drawers for 1/2-, 1/4-, and 1/8-size drawing. Drawers have front metal plan depressor and rear hood to keep documents flat and orderly. Dust covers optional. 10-drawer files have patented tracing lifter for ease of retrieval. Able to stack three high on flush base. Files stack two high on base legs.

File physical paper capacity: 1000 sheets vellum per file.
100 sheets vellum per drawer in a 10 drawer file.
200 sheets vellum per drawer in a 5 drawer file.

File weight capacity: 20 lbs. (9.1 kg) per drawer in a 10 drawer file evenly distributed.
40 lbs. (18.2 kg) per drawer in a 5 drawer file evenly distributed.

Model No.

Hamilton Unit System Files

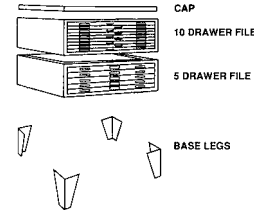

Base Option 7890X

For 24" x 36" Sheets		Overall Unit Sizes			Inside Drawer Sizes			Wt.	List Price
		W	H	D	W	H	D		
1J1	Flat Cap	43 5/16"	3/4"	33 1/4"	-	-	-	33#	\$463
1J15	Five-Drawer File	43 5/16"	15 3/8"	32 1/2"	39 1/2"	2"	29"	188#	\$2687
1J15D	Five-Drawer File, Dust Covers	43 5/16"	15 3/8"	32 1/2"	39 1/2"	2"	29"	195#	\$2976
1J117	Flush Base	43 5/16"	4"	32 1/2"	-	-	-	14#	\$437
1J100	Ten-Drawer File	43 5/16"	15 3/8"	32 1/2"	37 1/2"	3/4"	29"	421#	\$8072
7890X	Base Legs (set of 4)	-	6"	-	-	-	-	15#	\$332
7890Y	Base Legs (set of 4)	-	19 3/8"	-	-	-	-	45#	\$711

For 30" x 42" Sheets		Overall Unit Sizes			Inside Drawer Sizes			Wt.	List Price
		W	H	D	W	H	D		
2J1	Flat Cap	49 5/16"	3/4"	39 1/4"	-	-	-	44#	\$580
2J15	Five-Drawer File	49 5/16"	15 3/8"	38 1/2"	45 1/2"	2"	35"	233#	\$3183
2J15D	Five-Drawer File, Dust Covers	49 5/16"	15 3/8"	38 1/2"	45 1/2"	2"	35"	242#	\$3482
2J117	Flush Base	49 5/16"	4"	38 1/2"	-	-	-	16#	\$553
2J100	Ten-Drawer File	49 5/16"	15 3/8"	38 1/2"	43 1/2"	3/4"	35"	492#	\$9620
7890X	Base Legs (set of 4)	-	6"	-	-	-	-	15#	\$332
7890Y	Base Legs (set of 4)	-	19 3/8"	-	-	-	-	45#	\$711

For 36" x 48" Sheets		Overall Unit Sizes			Inside Drawer Sizes			Wt.	List Price
		W	H	D	W	H	D		
3J1	Flat Cap	55 5/16"	3/4"	45 1/4"	-	-	-	51#	\$711
3J15	Five-Drawer File	55 5/16"	15 3/8"	44 1/2"	51 1/2"	2"	41"	293#	\$3653
3J15D	Five-Drawer File, Dust Covers	55 5/16"	15 3/8"	44 1/2"	51 1/2"	2"	41"	304#	\$3952
3J117	Flush Base	55 5/16"	4"	44 1/2"	-	-	-	18#	\$663
3J100	Ten-Drawer File	55 5/16"	15 3/8"	44 1/2"	49 1/2"	3/4"	41"	635#	\$11099
7890X	Base Legs (set of 4)	-	6"	-	-	-	-	15#	\$332
7890Y	Base Legs (set of 4)	-	19 3/8"	-	-	-	-	45#	\$711

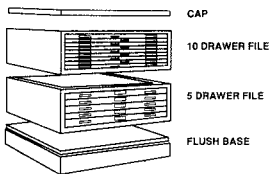

Base Option 3J117

For 42" x 72" Sheets		Overall Unit Sizes			Inside Drawer Sizes			Wt.	List Price
		W	H	D	W	H	D		
4J1	Flat Cap	79 5/16"	3/4"	51 1/4"	-	-	-	103#	\$1951
4J15D	Five-Drawer File, Dust Covers	79 5/16"	15 3/8"	50 1/2"	75 1/2"	1 1/2"	47"	525#	\$10855
4J17	Flush Base	79 5/16"	4"	50 1/2"	-	-	-	92#	\$1680

(Use Flush Base only.)

MAYLINE INTERLOCKING STEEL PLAN FILES



Available as five or ten-drawer stackable, interlocking units. Available with either front plan depressor or coated fabric dust covers. Stores up to 1,000 sheets. Able to stack three files on flush base. Files stack two high on base legs.

File physical paper capacity: 1000 sheets vellum per file.
100 sheets vellum per drawer in a 10 drawer file.
200 sheets vellum per drawer in a 5 drawer file.

File weight capacity: 20 lbs. (9.1 kg) per drawer in a 10 drawer file evenly distributed.
40 lbs. (18.2 kg) per drawer in a 5 drawer file evenly distributed.

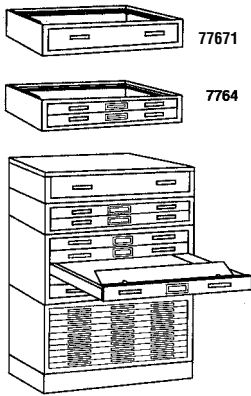

For 24" x 36" Sheets		Overall Unit Sizes			Inside Drawer Sizes			Wt.	List Price
		W	H	D	W	H	D		
7767U	Steel Cap	40 3/4"	3/4"	29 1/4"	-	-	-	25#	\$562
7767	Five Drawer File	40 3/4"	15 3/8"	28 3/8"	37"	2"	25 3/4"	171#	\$2431
7767D	Five-Drawer File, Dust Covers	40 3/4"	15 3/8"	28 3/8"	37"	2"	25 3/4"	178#	\$2717
7967	Ten-Drawer File	40 3/4"	15 3/8"	28 3/8"	37"	5/8"	26"	228#	\$4667
7967D	Ten-Drawer File, Dust Covers	40 3/4"	15 3/8"	28 3/8"	37"	5/8"	26"	230#	\$5273
7767W	Flush Base	40 3/4"	4"	-	-	-	-	14#	\$387
77671	Deep-Drawer File	40 3/4"	7 3/16"	28 3/8"	37"	4 3/4"	26"	65#	\$1542
7764	Two-Drawer File	40 3/4"	7 3/16"	28 3/8"	37"	2"	25 3/4"	78#	\$1505
7890X	Base Legs	41"	6"	28 5/8"	-	-	-	15#	\$332
7890Y	Base Legs	41"	19 3/8"	28 5/8"	-	-	-	45#	\$711

For 30" x 42" Sheets		Overall Unit Sizes			Inside Drawer Sizes			Wt.	List Price
		W	H	D	W	H	D		
7768U	Steel Cap	46 3/4"	3/4"	36 1/4"	-	-	-	30#	\$679
7768	Five-Drawer File	46 3/4"	15 3/8"	35 3/8"	43"	2"	32 3/4"	211#	\$2786
7768D	Five-Drawer File, Dust Covers	46 3/4"	15 3/8"	35 3/8"	43"	2"	32 3/4"	220#	\$3081
7968	Ten-Drawer File	46 3/4"	15 3/8"	35 3/8"	43"	5/8"	33"	298#	\$5285
7968D	Ten-Drawer File, Dust Covers	46 3/4"	15 3/8"	35 3/8"	43"	5/8"	33"	300#	\$5985
7768W	Flush Base	46 3/4"	4"	35 3/8"	-	-	-	16#	\$427
7890X	Base Legs	47"	6"	35 5/8"	-	-	-	15#	\$332
7890Y	Base Legs	47"	19 3/8"	35 5/8"	-	-	-	45#	\$711

For 36" x 48" Sheets		Overall Unit Sizes			Inside Drawer Sizes			Wt.	List Price
		W	H	D	W	H	D		
7769U	Steel Cap	53 3/4"	3/4"	42 1/2"	-	-	-	45#	\$877
7769	Five-Drawer File	53 3/4"	15 3/8"	41 3/8"	50"	2"	38 3/4"	257#	\$3367
7769D	Five-Drawer File, Dust Covers	53 3/4"	15 3/8"	41 3/8"	50"	2"	38 3/4"	267#	\$3655
7969	Ten-Drawer File	53 3/4"	15 3/8"	41 3/8"	50"	5/8"	39"	365#	\$6356
7969D	Ten-Drawer File, Dust Covers	53 3/4"	15 3/8"	41 3/8"	50"	5/8"	39"	375#	\$7227
7769W	Flush Base	53 3/4"	4"	41 3/8"	-	-	-	18#	\$517
7890X	Base Legs	54"	6"	41 5/8"	-	-	-	15#	\$332
7890Y	Base Legs	54"	19 3/8"	41 5/8"	-	-	-	45#	\$711

File Lock Description		Wt.	List Price
90J006	Locking Device, steel latch fits all 5- and 10- drawer steel files	2#	\$112

Partition for Metal Plan Files (Black only)			
7965	Plastic, magnetic divider for all steel 5-drawer files 6" L x 1 5/8"W x 1 5/8" H	6 per pack	1# \$66

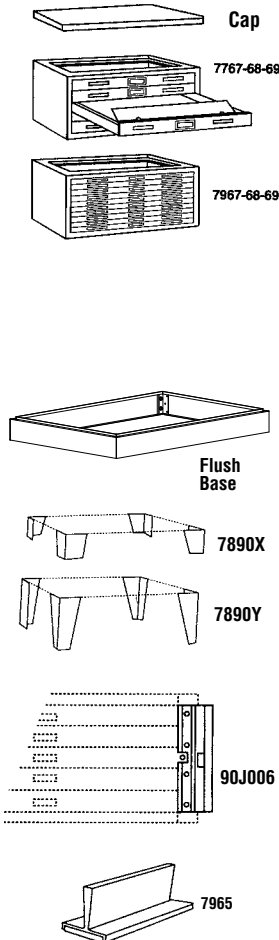

WORKSPACES
DESKS & STORAGE
TABLES
SEATING
HIGH DENSITY STORAGE
MAIL ROOM FURNITURE
TECHNOLOGY FURNITURE
DRAFTING FURNITURE
ACCESSORIES
PRODUCT INDEX

HAMILTON™ REGULAR SERIES PLAN FILES SPECIFICATIONS (NOTE: Not on GSA)

Interlocking steel plan files are designed for ease of stacking. Drawers have front plan depressor and rear hood to keep documents flat and orderly. Drawers with dust covers are optional. May be integrated with Mayline® files. Able to be stacked three high on flush base. Files stack two high on base legs.

File physical paper capacity: 1000 sheets vellum per file.
 100 sheets vellum per drawer in a 10 drawer file.
 200 sheets vellum per drawer in a 5 drawer file.

File weight capacity: 20 lbs. (9.1 kg) per drawer in a 10 drawer file evenly distributed.
 40 lbs. (18.2 kg) per drawer in a 5 drawer file evenly distributed.

Model No.

For 24" x 36" Sheets		Overall Unit Sizes			Inside Drawer Sizes			Wt.	List Price
		W	H	D	W	H	D		
5J1	Flat Cap	40 3/4"	3/4"	29 1/4"	-	-	-	25#	\$562
5J15	Five-Drawer File	40 3/4"	15 3/8"	28 3/8"	37"	2"	25 3/4"	171#	\$2511
5J15D	Five-Drawer with Dust Covers	40 3/4"	15 3/8"	28 3/8"	37"	2"	25 3/4"	178#	\$2793
5J117	Flush Base	40 3/4"	4"	28 3/8"	-	-	-	14#	\$387

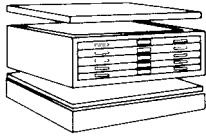

For 30" x 42" Sheets		Overall Unit Sizes			Inside Drawer Sizes			Wt.	List Price
		W	H	D	W	H	D		
6J1	Flat Cap	46 3/4"	3/4"	36 1/4"	-	-	-	30#	\$679
6J15	Five-Drawer File	46 3/4"	15 3/8"	35 3/8"	43"	2"	32 3/4"	211#	\$2875
6J15D	Five-Drawer with Dust Covers	46 3/4"	15 3/8"	35 3/8"	43"	2"	32 3/4"	220#	\$3171
6J117	Flush Base	46 3/4"	4"	35 3/8"	-	-	-	16#	\$427

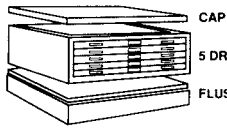

For 36" x 48" Sheets		Overall Unit Sizes			Inside Drawer Sizes			Wt.	List Price
		W	H	D	W	H	D		
7J1	Flat Cap	53 3/4"	3/4"	42 1/4"	-	-	-	45#	\$877
7J15	Five-Drawer File	53 3/4"	15 3/8"	41 3/8"	50"	2"	38 3/4"	257#	\$3447
7J15D	Five-Drawer with Dust Covers	53 3/4"	15 3/8"	41 3/8"	50"	2"	38 3/4"	268#	\$3744
7J117	Flush Base	53 3/4"	4"	41 3/8"	-	-	-	18#	\$517
7890X	Base Legs (set of 4)	-	6"	-	-	-	-	15#	\$332
7890Y	Base Legs (set of 4)	-	19 3/8"	-	-	-	-	45#	\$711

MUSEUM FILES SPECIFICATIONS



Self-contained Museum Files have integral cap and can be bolted together for stacking. Drawers have front metal plan depressor and rear hood to keep documents flat and orderly. Has fully enclosed drawer cabinet bottom. Drawer suspension uses greaseless nylon rimmed ball bearings to eliminate metal to metal contact and abrasion. Paint finish specially formulated to prevent outgassing. Optional high base supports one file. Able to stack three files on flush base.

File physical paper capacity: 1000 sheets vellum per file.
 100 sheets vellum per drawer in a 10 drawer file.
 200 sheets vellum per drawer in a 5 drawer file.

File weight capacity: 20 lbs. (9.1 kg) per drawer in a 10 drawer file evenly distributed.
 40 lbs. (18.2 kg) per drawer in a 5 drawer file evenly distributed.

Model No.

For 24" x 36" Sheets		Overall Unit Sizes			Inside Drawer Sizes			Wt.	List Price
		W	H	D	W	H	D		
7667	Five-Drawer File	40 3/4"	15 3/8"	28 3/8"	37"	2"	25 3/4"	175#	\$2863
7677	Ten-Drawer File	40 3/4"	15 3/8"	28 3/8"	37"	5/8"	25 3/4"	345#	\$5724
7767W	Flush Base for 7667 & 7677	40 3/4"	4"	28 3/8"	-	-	-	14#	\$387
7877	20" High Base	40 3/4"	20"	28 3/8"	-	-	-	52#	\$792

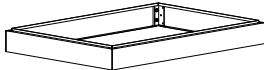
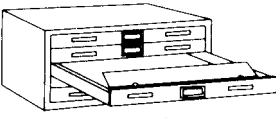

Shown with Flush Base

For 30" x 42" Sheets		Overall Unit Sizes			Inside Drawer Sizes			Wt.	List Price
		W	H	D	W	H	D		
7668	Five-Drawer File	46 3/4"	15 3/8"	35 3/8"	43"	2"	32 3/4"	225#	\$3301
7678	Ten-Drawer File	46 3/4"	15 3/8"	35 3/8"	43"	5/8"	32 3/4"	445#	\$5979
7768W	Flush Base for 7668 & 7678	46 3/4"	4"	35 3/8"	-	-	-	16#	\$427
7878	20" High Base	46 3/4"	20"	35 3/8"	-	-	-	63#	\$896

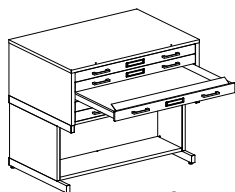

Shown with High Base

For 36" x 48" Sheets		Overall Unit Sizes			Inside Drawer Sizes			Wt.	List Price
		W	H	D	W	H	D		
7669	Five-Drawer File	53 3/4"	15 3/8"	41 3/8"	50"	2"	38 3/4"	280#	\$3915
7679	Ten-Drawer File	53 3/4"	15 3/8"	41 3/8"	50"	5/8"	38 3/4"	550#	\$7099
7769W	Flush Base for 7669 & 7679	53 3/4"	4"	41 3/8"	-	-	-	18#	\$517
7879	20" High Base	53 3/4"	20"	41 3/8"	-	-	-	70#	\$988

WOOD PLAN FILES (NOTE: Not on GSA)

- Drawer fronts and case sides are finished in oak.
- Drawer bottoms are hardboard.
- Antique brass drawer pulls.
- Bases are shipped unassembled.

File physical paper capacity: 1000 sheets vellum per file.
100 sheets vellum per drawer in a 10 drawer file.
200 sheets vellum per drawer in a 5 drawer file.

File weight capacity: 20 lbs. (9.1 kg) per drawer in a 10 drawer file evenly distributed.
40 lbs. (18.2 kg) per drawer in a 5 drawer file evenly distributed.

Model No.

Wood Plan Files

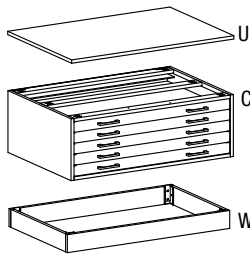

	For 24" x 36" Sheets	Overall Unit Sizes			Inside Dimensions			Wt.	List Price
		W	H	D	W	H	D		
7717U	Cap	40 13/16"	3/4"	27 3/4"	-	-	-	30#	\$667
7717C	Five-Drawer File	40 11/16"	13 7/8"	27 3/8"	37 5/8"	17/8"	25"	112#	\$2453
7717W	Flush Base	40 11/16"	4"	25 3/8"	-	-	-	15#	\$639

Finishes: Standard - Naturalist, Golden Oak, or Unfinished
Both sides of shelf unit.

	For 30" x 42" Sheets	Overall Unit Sizes			Inside Dimensions			Wt.	List Price
		W	H	D	W	H	D		
7718U	Cap	45 5/8"	3/4"	34 3/4"	-	-	-	36#	\$863
7718C	Five-Drawer File	45 1/2"	13 7/8"	34 3/8"	42 3/8"	1 7/8"	32"	140#	\$2644
7718W	Flush Base	45 1/2"	4"	32 3/8"	-	-	-	18#	\$710

Finishes: Standard - Naturalist, Golden Oak, or Unfinished
Both sides of shelf unit.

	For 36" x 48" Sheets	Overall Unit Sizes			Inside Dimensions			Wt.	List Price
		W	H	D	W	H	D		
7719U	Cap	53 7/16"	3/4"	40 3/4"	-	-	-	52#	\$1059
7719C	Five-Drawer File	53 5/16"	13 7/8"	40 3/8"	50 3/16"	15/8"	38"	172#	\$3497
7719W	Flush Base	53 5/16"	4"	38 3/8"	-	-	-	22#	\$826

Finishes: Standard - Naturalist, Golden Oak, or Unfinished
Both sides of shelf unit included.

MOBILE B-SIZE DRAWER FILE (NOTE: Not on GSA)

Eight-drawer steel file stores up to 2,500 sheets. All-steel construction. Four casters: 2 locking, 2 non-locking. Gang lock included.
Standard Finishes: Sand Beige, White, Black, Gray

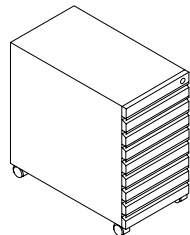

Model No.	Overall Unit Sizes			Inside Dimensions			Wt.	List Price
	W	H	D	W	H	D		
9P810	15 1/4"	27 1/8"	27 3/4"	12 3/4"	1 3/4"	23 1/2"	109#	\$1572

ROLL FILE CART

- Two sizes, wire construction
- 2" poly dual wheel non-scarring casters
- Insert included to accommodate various size rolled documents
- Easy to assemble
- Black finish only

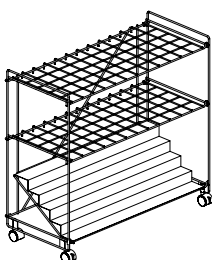

Model No.	Description	Length	Height	Depth	Wt.	List Price
❖ RF36	36 - 3 1/2" Openings	34"	32"	15"	28#	\$272
❖ RF60	60 - 2 1/2" Openings	34"	32"	15"	28#	\$286

❖ Indicates Quick-Ship models.