

Office Doctor Discount Office Furniture

[www.OfficeDr.com](http://www.OfficeDr.com) 856-368-9085

Groupe Lacasse Half Price Sale On Now

Take Half Off the List Prices in this PDF

**Call 856-368-9085 Now**

Free Layout & Design Service

**Metal Storage Cabinets & Files**



## TABLE OF CONTENTS

AVAILABLE SPECIALS .....	2
QUICKSHIP PROGRAM .....	2
SPECIFICATIONS .....	3
CHOOSING THE RIGHT STORAGE FURNITURE .....	3
CAPACITY AND FILING SPACE .....	4
COUNTERWEIGHTS AND ANCHORS .....	5
LOCKING PROGRAM .....	5
LATERAL FILES / CABINETS AND BOOKCASES .....	6
WARDROBES / MULTIFUNCTION STORAGE FURNITURE .....	7
VERTICAL FILES / COMBINED TOWERS / PEDESTALS .....	8
OPTION SPECIFICATIONS AND FINISHES .....	9

METAL STORAGE FURNITURE .....	10
LATERAL FILES .....	10
CABINETS .....	10-11
BOOKCASES .....	11
WARDROBES .....	11
MULTIFUNCTION STORAGE FURNITURE .....	11-12
VERTICAL FILES .....	12-13
LAMINATE TOPS .....	13
PEDESTALS .....	13-14
COMBINED TOWERS .....	14-15
ACCESSORIES .....	15-16

## FIND OUT ABOUT OUR AVAILABLE SPECIALS!

Other special products are also available upon request: lockers, plan files, display cases, filing bookcases, etc. For information purposes, here are some examples of special products:

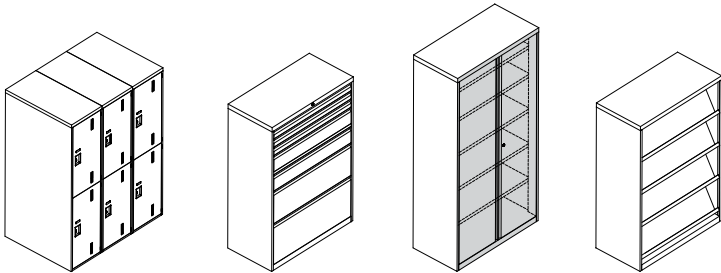

Customized locker

Multidrawer lateral file

2-tone cabinet  
72" H (1829 mm)

Display case

### CUSTOMIZED COLORS:

- It is possible to get a two-tone layout by specifying the front and case colors.
- It is also possible to develop a storage unit with your choice of color.

### CUSTOMIZED DRAWERS DIMENSIONS AND CONFIGURATIONS:

- Standard-sized cases can easily accommodate your choice of drawer heights: 3" (76 mm), 6" (152 mm), 9" (229 mm), 12" (305 mm), 13 1/2" (343 mm) and 15" (381 mm).
- A storage unit can also be made with special dimensions (W x H x D).

### IMPORTANT:

No minimum quantity necessary. However, certain conditions, dimensional limitations and development costs may apply. For any special request, please send your request to [special@groupelacasse.com](mailto:special@groupelacasse.com) or contact Customer Service for further information.

### LACASSE QUICKSHIP PROGRAM\*

Products and suggested layouts identified by this pictogram are part of the Lacasse quick delivery program.

\* Due to current market conditions, always refer to our Lead-Time Guide for a confirmation of our current Lacasse QuickShip lead-times.



### PROGRAM CONDITIONS AND LIMITATIONS:

- Maximum of five (5) of each item and each color per order.
- QuickShip products are ready for shipment after reception of a ready-to-process order and delivered on next available trailer.

### IMPORTANT:

Place QuickShip orders separately from regular Lacasse orders. When preparing QuickShip orders, indicate the code "QS" in front of the QuickShip product code; i.e.: QSRI DFS-183628LF2.

# SPECIFICATIONS

## CHOOSING THE RIGHT STORAGE FURNITURE

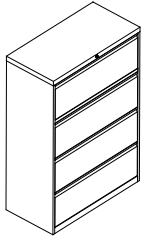

**Lateral file with fixed fronts**

Offers a superior filing capacity. Perfect for any workstation; allowing an easy access to files.

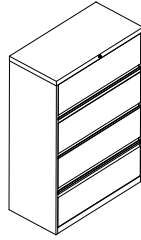

**Lateral file with receding fronts and roll-out shelves**

Designed for a quick consultation of documents with end-tabs. Perfect for the medical field.

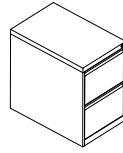

**Pedestal / vertical file**

Designed to be integrated into all your projects and requires little floor space. Vertical file is ideal for long-term filing.

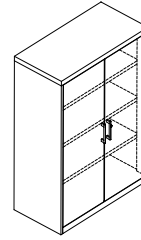

**Cabinet / bookcase**

Adjustable shelves allow an optimal use of storage space. Perfect for binders, books, catalogues and stationery.

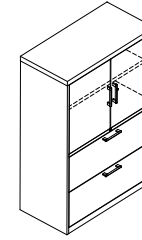

**Multifunction storage unit / combined towers**

The different compartments offer diversified storage space. Perfect for a small volume of filing and for an individual workstation.

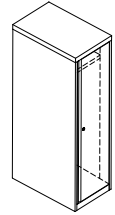

**Wardrobe**

Offers a safe personal storage space for clothes, shoes, bags, etc.

### General Information

- In this price book, dimensions are exact and may differ from other Groupe Lacasse collections.
- Metal storage furniture is GREENGUARD GOLD certified and meets or exceeds ANSI/BIFMA standards. See product specifications for more details.
- Products are made from 68% recycled materials and are 99.5% recyclable.
- Furniture on glides is shipped assembled and ready to use.
- Cleaning method: clean furniture with a damp cloth and mild soap. Dry the surface with a soft cloth.

### Design

- All products in this collection were carefully designed with horizontal lines that maintain a uniform appearance among the different storage units.
- Inset drawers and doors create a sleek and neutral look.

- The case construction with smooth seams and no overlaps allows to place the storage units side by side without creating unwanted gaps.
- The storage furniture gets its impeccable look from a smooth-finish powder paint.

### General Specifications

- Each unit is equipped with 4 levelers that are accessible from the inside and allow an adjustment of 1" (25 mm), ensuring stability on uneven floors.
- The inside of storage units and drawers are the same color as the outside.
- Storage units with a height of 27 7/8" (708 mm) can support a work surface with a conventional height of 29" (737 mm) or more.
- Adding a laminate top on a unit that has a height of 27 7/8" (708 mm) or 40 1/16" (1018 mm) creates a work space at sitting or standing heights. See page 13.
- Classic (Z) and Straight (K) pulls are interchangeable; 5" (128 mm) on center drillings.

### Steel Gauges

Storage furniture is entirely made and welded with first-quality cold-rolled steel. Please note that the lower the gauge, the thicker the steel.

	Lateral files / Multifunction files / Low storage units	Vertical files / Pedestal	Cabinets / Wardrobes	Bookcases	Cabinets-Lateral files combos	Combined towers
Top	20	20	20	20	20	20
Side	20	20	20	20	20	20
Back	20	20 / 14	20	20	20	20
Bottom	20	16	16	16	20	16
Drawer front	20	20	-	-	20	20
Drawer side	18	20	-	-	18	20
Drawer bottom	20	20	-	-	20	20
Top reinforcement	18	18	-	-	18	-
Side reinforcement	18	18	-	-	18	-
Crossbar	20*	20* / -	-	-	20	-
Leveler support	16	-	-	-	16	-
Flip system	20*	-	-	-	-	-
Door	-	-	20	-	20	20*
Shelf	-	-	20	20	20	20
Shelf support	-	-	18 / -	18	18	18

\* If applicable.

# SPECIFICATIONS

## LATERAL FILES CAPACITY AND FILING SPACE

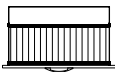
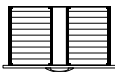
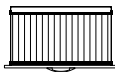
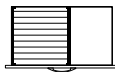
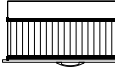
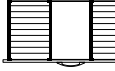
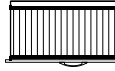
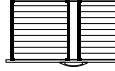
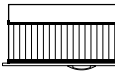
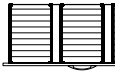
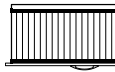
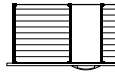
Fixed front				Filing Space - Letter Size		Espace de classement - Format légal	
Tiroirs	W x D x H (in)	W x D x H (mm)	Capacity	Left / Right	Front / Rear*	Left / Right	Front / Rear*
30" W (762 mm)	26 3/4 x 15 1/16 x 11 5/8	679 x 383 x 295	90 lb / 40,8 kg	 26 3/4" (679 mm)	 30 1/8" (765 mm)	 26 3/4" (679 mm)	 15 1/16" (383 mm)
36" W (914 mm)	32 3/4 x 15 1/16 x 11 5/8	832 x 383 x 295	105 lb / 47,6 kg	 32 3/4" (832 mm)	 30 1/8" (765 mm)	 32 3/4" (832 mm)	 30 1/8" (765 mm)
42" W (1067 mm)	38 3/4 x 15 1/16 x 11 5/8	984 x 383 x 295	125 lb / 56,7 kg	 38 3/4" (984 mm)	 45 3/16" (1148 mm)	 38 3/4" (984 mm)	 30 1/8" (765 mm)

\* Requires front-to-back hanging bars, sold separately. See page 16.

**Note:** Fixed and roll-out shelves with retractable door have an interior filing height of 10 5/8" (270 mm) instead of 11 5/8" (295 mm).

## CABINETS AND BOOKCASES CAPACITY AND FILING SPACE

Storage unit	Shelves Dimensions				Capacity (weight uniformly distributed)	
	Cabinet		Bookcase		Cabinet	Bookcase
	W x D x H (in)	W x D x H (mm)	W x D x H (in)	W x D x H (mm)		
30" W (762 mm)	29 3/4 x 14 1/4 x 3/4	756 x 362 x 19	29 3/4 x 16 3/4 x 3/4	756 x 425 x 19	90 lb / 40,8 kg	105 lb / 47,6 kg
36" W (914 mm)	35 3/4 x 14 1/4 x 3/4	908 x 362 x 19	35 3/4 x 16 3/4 x 3/4	908 x 425 x 19	105 lb / 47,6 kg	125 lb / 56,7 kg
42" W (1067 mm)	41 3/4 x 14 1/4 x 3/4	1060 x 362 x 19	41 3/4 x 16 3/4 x 3/4	1060 x 425 x 19	125 lb / 56,7 kg	145 lb / 65,8 kg

## STORAGE SPACE AND CAPACITY OF VERTICAL FILES, TOWERS AND PEDESTALS

Storage unit	Interior Dimensions*				Capacity (weight uniformly distributed)	
	Box drawer		File drawer		Box drawer	File drawer
	W x D x H (in)	W x D x H (mm)	W x D x H (in)	W x D x H (mm)		
18" D (457 mm)	12 x 16 x 5 3/8	305 x 406 x 137	12 x 16 x 11 5/8	305 x 406 x 295	17 lb / 7,7 kg	36 lb / 16,3 kg
22" D (457 mm)	12 x 16 x 5 3/8	305 x 406 x 137	12 x 16 x 11 5/8	305 x 406 x 295	17 lb / 7,7 kg	36 lb / 16,3 kg
24" D (610 mm)	12 x 16 x 5 3/8	305 x 406 x 137	12 x 16 x 11 5/8	305 x 406 x 295	17 lb / 7,7 kg	36 lb / 16,3 kg
28" D Letter (711 mm)	12 x 24 x 5 3/8	305 x 610 x 137	12 x 24 x 11 5/8	305 x 610 x 295	26 lb / 11,8 kg	54 lb / 24,5 kg
28" D Legal (711 mm)	15 x 24 x 5 3/8	381 x 610 x 137	15 x 24 x 11 5/8	381 x 610 x 295	32 lb / 14,5 kg	67 lb / 30,4 kg

\* Mobile pedestals: remove in height 1" (25 mm) per file drawer and 1/2" (13 mm) per box drawer.

COUNTERWEIGHTS AND ANCHORS

In order to meet ANSI/BIFMA standards of stability, some products must be installed under a work surface, be ganged/anchored or have a counterweight. Please see each product's Specifications section for more details.

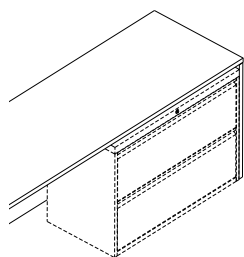

Installation under a work surface

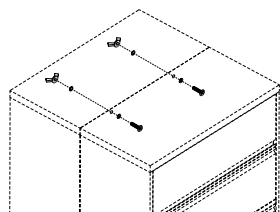

Back-to-back or side-by-side ganging\*

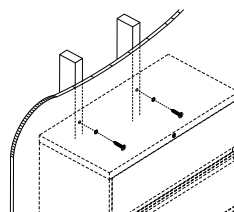

Wall anchoring

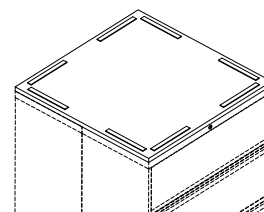

Ganging with a laminate top

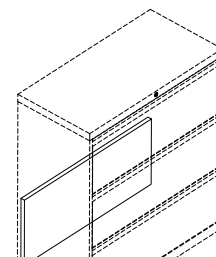

Factory-installed or optional counterweight\*\*

\* Ganging kit RINNN-GKIT sold separately, page 16.

\*\* Refer to the price book for more details (see pages 15-16).

LOCKING PROGRAM

Standard Lock

- All storage units except bookcases are equipped with a single lock system. Cabinets/Lateral files combos have 2 locks.
- Each key lock has a factory-installed lock plug and key numbers are attributed in random fashion for each storage unit.
- It is possible to change lock plugs and install a keyed alike system. Master Key and Control Key also offered. For further information, contact the Groupe Lacasse Customer Service.
- The locking system accepts a key lock (standard) or an electronic lock (option).

Electronic Lock (option)

- The Versa Mini, from Numeris by Digilock, is an electronic lock intended to secure storage furniture for hospitality, retail and healthcare professionals.
- When specified in option, the electronic lock (D) is factory installed. A key lock on an existing unit can be changed for an electronic lock (see page 16).
- Installed horizontally with keypad on the left on a file and vertically installed with keypad at top on a cabinet or a wardrobe.

- The lock uses 2 small coin cell lithium batteries for an average of 50,000 actuations. The battery compartment is located within the front of the lock to allow changing batteries without unlocking or opening the door.
- The keypad interface allows the user to operate the lock with a 4 to 7-digit user code for a multitude of combinations.
- Manager Keys (required and sold separately, see page 16) provide bypass access in case the user is unable to access their storage unit. It can also operate the locks in case of battery failure. Manager Keys are programmed into the lock system by a unique Programming Key (required and sold separately, see page 16).
- The lock is programmed to assigned use functionality by default, which allows up to 20 simultaneous user codes. It can be easily changed to shared use functionality with a Programming Key.
- In shared use, the lock is designed for day use applications. The user chooses an available storage unit and operates it with a self-selected user credential code. Once the storage unit is vacated, it becomes available for a different user.
- Manager Keys are programmed into the lock system by a unique Programming Key (required and sold separately, see page 16).

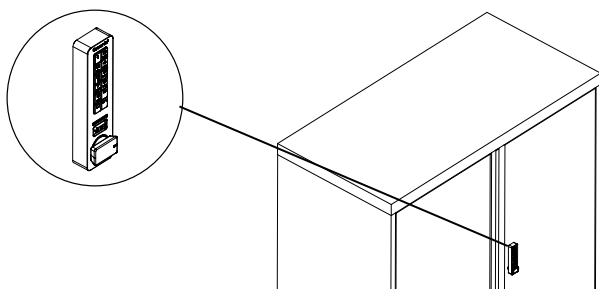

Vertical installation

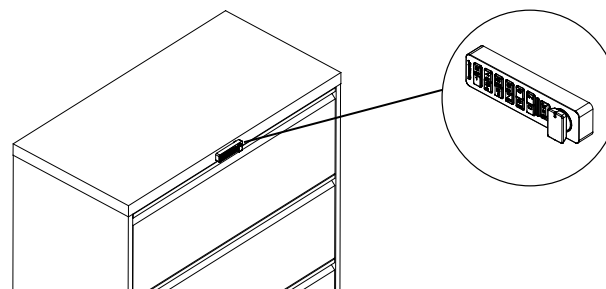

Horizontal installation

## SPECIFICATIONS

### LATERAL FILES

- 15 different configurations are possible; 2, 3, 4, 5 or 6-high, 30" W (762 mm), 36" W (914 mm) or 42" W (1067 mm) and 18" D (457 mm).
- Drawers come with a fixed front (D) or a receding front and a roll-out shelf (R).
- A posting shelf (P) at a height of 40" (1016 mm) is available in option to make reading and filing easier. Offered on 4, 5 and 6-drawer files.
- On all configurations, the 1<sup>st</sup> drawer from the bottom has a fixed front (D). The 5<sup>th</sup> drawer has a receding front with a roll-out shelf (R). The 6<sup>th</sup> drawer has a receding front and a fixed shelf (F).

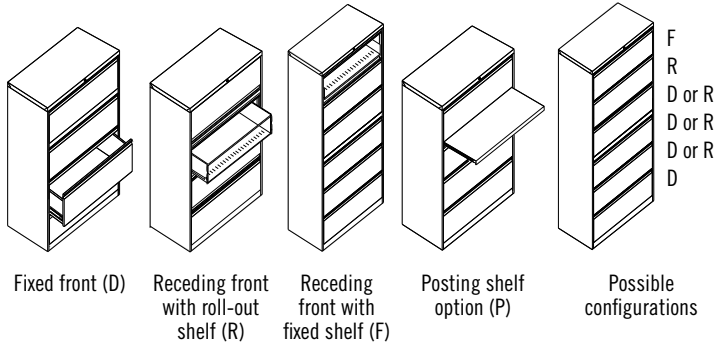

- Drawers are 12" H (305 mm) and can accommodate letter, legal or A4-size documents.
- In order to meet ANSI/BIFMA stability standards, lateral file must be installed under a work surface, be attached or have a counterweight (not required for 5 or 6-drawer files).
- A lock is installed above the highest drawer, allowing to lock all drawers at once.

- Drawers and roll-out shelves are equipped with full-extension telescopic slides. The ball-bearing system is designed to support intensive use.
- The 2-drawer file is also offered in universal height that fits under a 28" H (711 mm) work surface. That file doesn't offer the same visual compatibility when side-to-side with other units from this collection.
- Label holder included on each integrated pull for easy identification.
- Two hanging bars are included with each drawer to allow side-to-side filing. For front-to-back filing and dividers, see page 16.

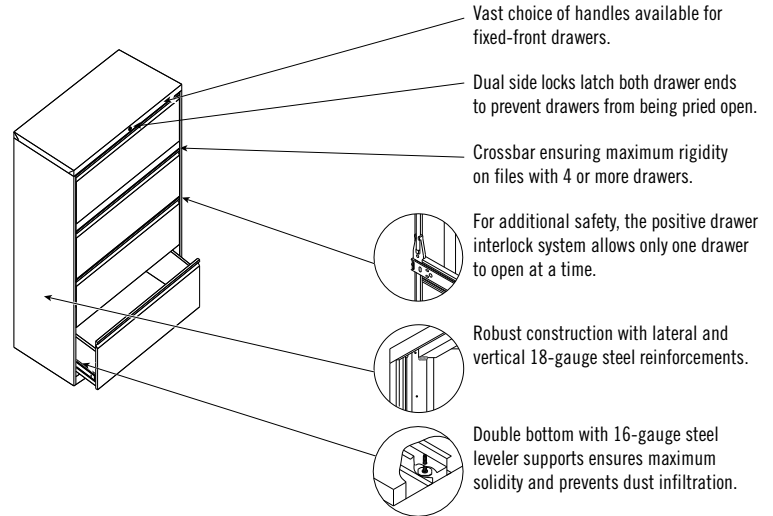

### CABINETS AND BOOKCASES

- 15 different configurations are possible; 2, 3, 4, 5 or 6 compartments high, 30" W (762 mm), 36" W (914 mm) or 42" W (1067 mm) and 18" D (457 mm).
- A half-height lock is installed on the right door of the cabinet and allows to lock the 2 doors, from the bottom up.
- Interior space allows to store standard binders on all shelves except one (ex.: a 4-compartment cabinet or bookcase can hold binders on 3 shelves only).
- Shelves are adjustable every 1½" (38 mm). Additional shelves are available (see page 15).

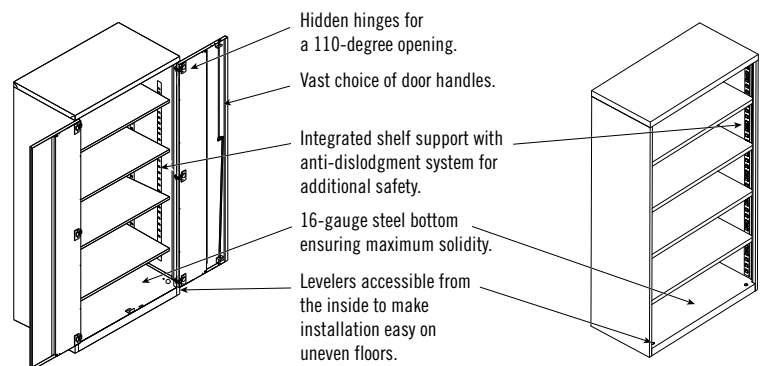

## WARDROBES

- 8 different configurations are possible; hinges on left/right, 53 <sup>3</sup>/<sub>8</sub>" H (1356 mm) and 65 <sup>1</sup>/<sub>2</sub>" H (1664 mm), 15" W (381 mm) or 18" W (457 mm) and 24" D (610 mm).
- A half-height lock is installed on the door.
- A fixed shelf with a clothing hanger bar is located at 7 <sup>1</sup>/<sub>2</sub>" H (191mm) from the top and allows the storage of personal effects.

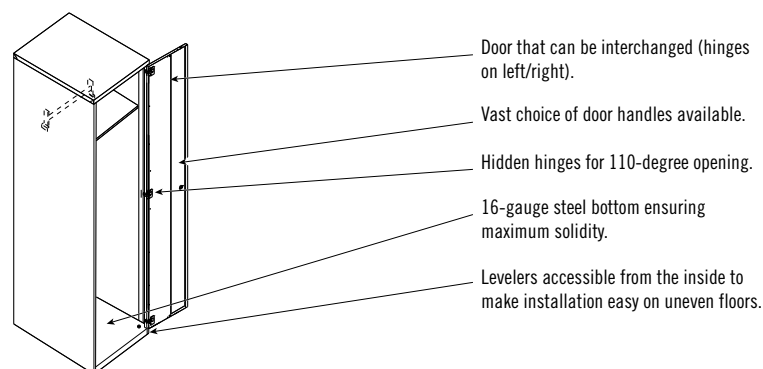

## CABINETS / LATERAL FILES COMBOS

- 12 different configurations are possible; 2, 3, 4 or 5 compartments high, 30" W (762 mm), 36" W (914 mm) or 42" W (1067 mm) and 18" D (457 mm).
- In order to meet ANSI/BIFMA stability standards, 53 <sup>3</sup>/<sub>8</sub>" H (1356 mm) or less cabinets/files must be attached or have a counterweight.
- Two independent locks for cabinet and drawers.
- Drawers are equipped with full-extension telescopic slides. The ball-bearing system is designed to support intensive use.
- Label holder included on each integrated pull for easy identification.
- Two hanging bars are included with each drawer to allow side-to-side filing. For front-to-back filing and dividers, see page 16.
- Shelves are adjustable every 1 <sup>1</sup>/<sub>2</sub>" (38 mm). Additional shelves are available (see page 15).

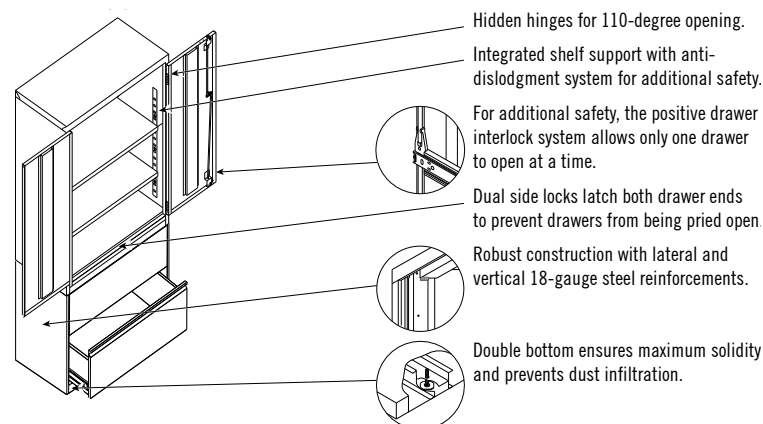

## MULTIFUNCTION FILES

- 6 different configurations are possible; left or right box drawers, 30" W (762 mm), 36" W (914 mm) or 42" W (1067 mm) and 18" D (457 mm).
- In order to meet ANSI/BIFMA stability standards, multifunction files must be installed under a work surface, be attached or have a counterweight.
- Box drawers width is 12" (305 mm) for a 30" W (914 mm) unit, 18" (457 mm) for a 36" W (914 mm) unit, and 24" (610 mm) for a 42" W (1067 mm) unit.
- Central lock locks all drawers at once.
- Pencil tray included in the first box drawer.
- Label holder included on each integrated pull of lateral file drawer for easy identification.
- Two hanging bars are included with file drawers to allow side-to-side filing. For front-to-back filing and dividers, see page 16.
- Laminate tops and cushions are available. See pages 13 and 15.

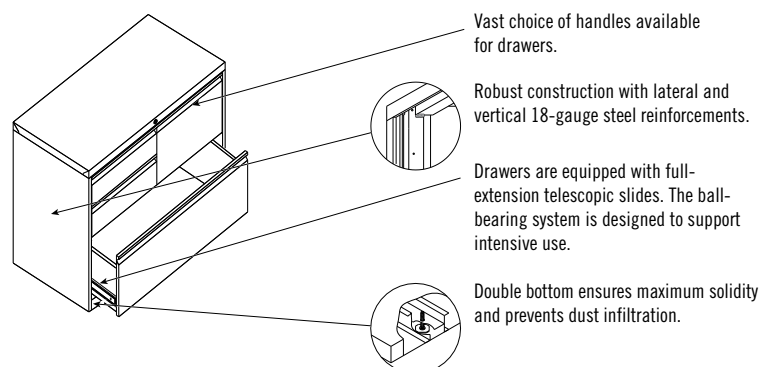

## COMBINED TOWERS

- 32 different configurations are possible with a cabinet or bookcase combined with box and file drawers, with or without a wardrobe; 53 3/8" (1356 mm) and 65 1/2" (1664 mm) in height, with a width of 14 3/4" (375 mm) or 23 3/4" (604 mm).
- The wardrobe, cabinet and pedestal each have their own lock, making it possible to lock each compartment independently.
- The drawers are equipped with full-extension telescopic slides. The ball bearing system is designed to support intensive use.
- Combined towers with a height of 53 3/8" (1356 mm) include 1 shelf, adjustable each 1 1/2" (38 mm). Combined towers with a height of 65 1/2" (1664 mm) include 2 shelves.
- Wardrobe and cabinet open outward. Cabinet hinges are interchangeable. Wardrobe has a clothing hanger bar.
- Pencil tray included in the first box drawer, and two hanging bars to allow side-to-side filing are included in each file drawer.
- Label holder included on each integrated file drawer pull for easy identification.

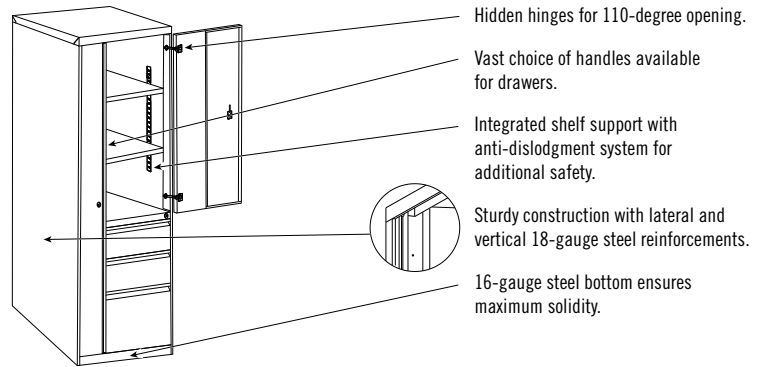

## VERTICAL FILES

- 8 different configurations are possible; 2, 3, 4 or 5-high, 14 3/4" W (375 mm) or 17 3/4" W (451 mm) and 28" D (711 mm).
- In order to meet ANSI/BIFMA stability standards, vertical files with 3 or less drawers must be attached or have a counterweight.
- Drawers are 12" H (305 mm) and can accommodate letter, legal or A4-size documents. They are available with fixed front (D).
- A lock is installed above the highest drawer, allowing to lock all drawers at once.
- Label holder included on each integrated pull for easy identification.
- Full-height sides of drawers allow front-rear filing. For dividers and compressors, see page 16.

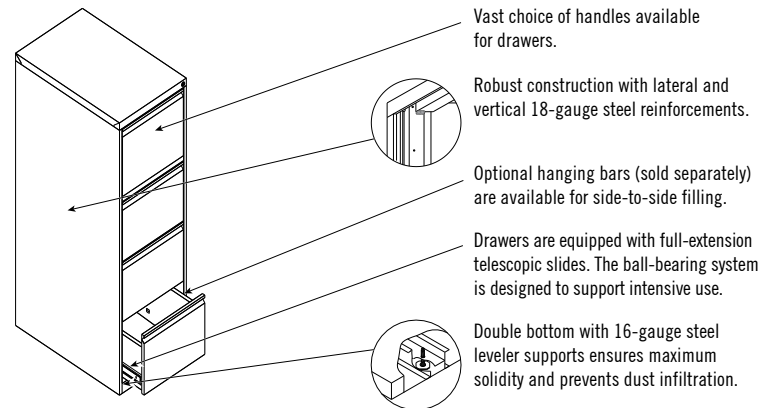

## PEDESTALS

- 15 different configurations are possible: 3 drawer configurations with a depth of 18" (457 mm), 22" (559 mm) and 28" (711 mm). Offered on glides or casters.
- The pedestals meet ANSI/BIFMA stability standards and include a counterweight when necessary.
- The fixed pedestal has a box drawer with a height of 6" (152 mm) and a file drawer with a height of 12" (305 mm).
- The mobile pedestal has a box drawer with a height of 5 1/2" (140 mm) and a file drawer with a height of 11" (279 mm).
- A single lock locks all drawers simultaneously.
- Pencil tray included in the first box drawer, and two hanging bars to allow side-to-side filing are included in each file drawer.
- Label holder included on each integrated file drawer pull for easy identification.
- For dividers and compressors, see page 16.
- The mobile pedestal can receive a cushion (RINNN-CU \_ \_ \_ \_).

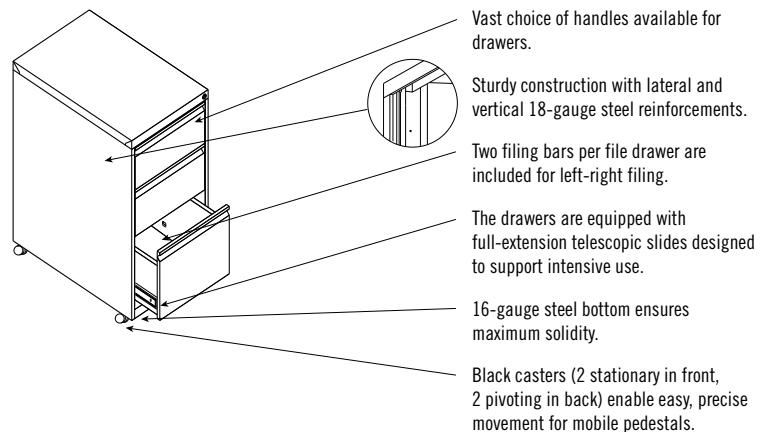

# METAL STORAGE FURNITURE

## SPECIFICATIONS

### INTEGRATED PULLS



**F – Full**

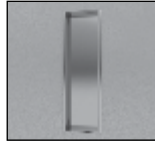

**R – Recessed**  
Non-painted  
aluminum

### EXTERNAL PULLS



**K – Classic**

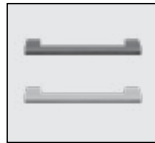

**Z – Straight**



**M – Modern**



**W – Modern**  
White

### ACCENT COLORS



**A – Anthracite Grey**



**S – Silver**

### LOCKS



**Standard**



**D – Electronic**  
Black or Nickel

### LACASSE QUICKSHIP PROGRAM\*

Products and suggested layouts identified by this pictogram are part of the Lacasse quick delivery program.

Please refer to page 2 for complete program details.

\* Due to current market conditions, always refer to our Lead-Time Guide for a confirmation of our current Lacasse QuickShip lead-times.



### CODIFICATION

Series	Options		
	Drawers	Pulls	Accent
<b>RI</b>	<b>D</b> Fixed front(s) <b>R</b> Recessed front(s)	<b>F</b> Full <b>R</b> Recessed <b>Z</b> Straight <b>K</b> Classic <b>M</b> Modern <b>W</b> White modern	<b>A</b> Anthracite Grey <b>S</b> Silver

### OPTIONS INTEGRATION

Electronic lock: indicate **D** at the end of the code and add **\$702** to price.

Ex: **RIDFA-184254LF4D**

Counterweight: indicate **W** at the end of the code and add **\$292** to price. Factory installed.

Ex: **RIDFA-183028LF2W**

Posting shelf for lateral files with 4 or more drawers: indicate **P** at the end of the code and add **\$309** to price. Ex: **RIDFA-183054LF4P**

### TOP - EDGEBANDING

#### N Edge

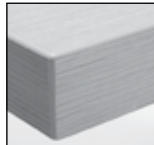

Smooth, 1/16" (1,5 mm) thick edge.

The **N** edge is matched with the finish specified for the surface.

### CODIFICATION

Series	Options	
	Finishes / thickness	Edgebanding
<b>R</b>	<b>1</b> Thermofused laminate top 1" <b>2</b> High-pressure laminate top 1" <b>5</b> Thermofused laminate top 1½" <b>6</b> High-pressure laminate top 1½"	<b>N</b> Smooth edge

### METAL STORAGE FURNITURE - PAINT COLORS

#### Standard Colors

**P01** Crystal Black  
**P04** Charcoal  
**P28** Anthracite Grey  
**P29** Willow Grey

**P44** Metallic Silver  
**P53** Snow

### CUSHIONS - CHOICE OF UPHOLSTERY

Several choices of upholstery are available. Please refer to the United Chair® Standard Upholstery Program.

	W x D x H (in)	W x D x H (mm)	Code	Price (\$)
--	----------------	----------------	------	------------

**LATERAL FILES**

**Fixed-front lateral files - integrated pulls**

The 5<sup>th</sup> drawer has a receding front with a roll-out shelf. The 6<sup>th</sup> drawer has a receding front with a fixed shelf. In order to comply with ANSI/BIFMA, a counterweight or anchoring solution is required for files with 4 or less drawers.

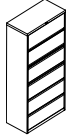

6-high.

42 x 18 x 77 <sup>5</sup> / <sub>8</sub>	1067 x 457 x 1972	RID__-184278LF6	4,785
36 x 18 x 77 <sup>5</sup> / <sub>8</sub>	914 x 457 x 1972	RID__-183678LF6	3,942
30 x 18 x 77 <sup>5</sup> / <sub>8</sub>	762 x 457 x 1972	RID__-183078LF6	3,817

Fixed fronts (D). Specify the pull code (F, R). Specify the accent color (A, S).

5-high.

42 x 18 x 65 <sup>1</sup> / <sub>2</sub>	1067 x 457 x 1664	RID__-184266LF5	3,817
36 x 18 x 65 <sup>1</sup> / <sub>2</sub>	914 x 457 x 1664	RID__-183666LF5	2,965
30 x 18 x 65 <sup>1</sup> / <sub>2</sub>	762 x 457 x 1664	RID__-183066LF5	2,888

Fixed fronts (D). Specify the pull code (F, R). Specify the accent color (A, S).

4-high.

42 x 18 x 53 <sup>3</sup> / <sub>8</sub>	1067 x 457 x 1356	RID__-184254LF4	2,956
36 x 18 x 53 <sup>3</sup> / <sub>8</sub>	914 x 457 x 1356	RID__-183654LF4	2,403
30 x 18 x 53 <sup>3</sup> / <sub>8</sub>	762 x 457 x 1356	RID__-183054LF4	2,389

Fixed fronts (D). Specify the pull code (F, R). Specify the accent color (A, S).

3-high.

42 x 18 x 40 <sup>1</sup> / <sub>16</sub>	1067 x 457 x 1018	RID__-184241LF3	2,346
36 x 18 x 40 <sup>1</sup> / <sub>16</sub>	914 x 457 x 1018	RID__-183641LF3	1,914
30 x 18 x 40 <sup>1</sup> / <sub>16</sub>	762 x 457 x 1018	RID__-183041LF3	1,854

Fixed fronts (D). Specify the pull code (F, R). Specify the accent color (A, S).

2-high.

42 x 18 x 27 <sup>1</sup> / <sub>8</sub>	1067 x 457 x 708	RID__-184228LF2	1,695
36 x 18 x 27 <sup>1</sup> / <sub>8</sub>	914 x 457 x 708	RID__-183628LF2	1,428
30 x 18 x 27 <sup>1</sup> / <sub>8</sub>	762 x 457 x 708	RID__-183028LF2	1,310

Fixed fronts (D). Specify the pull code (F, R). Specify the accent color (A, S).

2-high, universal height.

42 x 18 x 26 <sup>7</sup> / <sub>8</sub>	1067 x 457 x 683	RID__-184227LF2	1,695
36 x 18 x 26 <sup>7</sup> / <sub>8</sub>	914 x 457 x 683	RID__-183627LF2	1,428
30 x 18 x 26 <sup>7</sup> / <sub>8</sub>	762 x 457 x 683	RID__-183027LF2	1,310

Fixed fronts (D). Specify the pull code (F, R). Specify the accent color (A, S).

**Fixed-front lateral files - external pulls**

In order to comply with ANSI/BIFMA, a counterweight or anchoring solution is required.

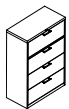

4-high.

42 x 18 x 53 <sup>3</sup> / <sub>8</sub>	1067 x 457 x 1356	RID__-184254LF4	2,956
36 x 18 x 53 <sup>3</sup> / <sub>8</sub>	914 x 457 x 1356	RID__-183654LF4	2,403
30 x 18 x 53 <sup>3</sup> / <sub>8</sub>	762 x 457 x 1356	RID__-183054LF4	2,389

Fixed fronts (D). Specify the pull code (K, M, Z, W). Specify the accent color (A, S).

3-high.

42 x 18 x 40 <sup>1</sup> / <sub>16</sub>	1067 x 457 x 1018	RID__-184241LF3	2,346
36 x 18 x 40 <sup>1</sup> / <sub>16</sub>	914 x 457 x 1018	RID__-183641LF3	1,914
30 x 18 x 40 <sup>1</sup> / <sub>16</sub>	762 x 457 x 1018	RID__-183041LF3	1,854

Fixed fronts (D). Specify the pull code (K, M, Z, W). Specify the accent color (A, S).

Electronic lock option (D): add \$702.

Counterweight option (W): add \$292.

Posting shelf option (P)\*: add \$309.

\*Available on file with 4 drawers.

	W x D x H (in)	W x D x H (mm)	Code	Price (\$)
--	----------------	----------------	------	------------

**Fixed-front lateral files - external pulls (cont'd)**



2-high.

42 x 18 x 27 <sup>1</sup> / <sub>8</sub>	1067 x 457 x 708	RID__-184228LF2	1,695
36 x 18 x 27 <sup>1</sup> / <sub>8</sub>	914 x 457 x 708	RID__-183628LF2	1,428
30 x 18 x 27 <sup>1</sup> / <sub>8</sub>	762 x 457 x 708	RID__-183028LF2	1,310

Fixed fronts (D). Specify the pull code (K, M, Z, W). Specify the accent color (A, S).

2-high, universal height.

42 x 18 x 26 <sup>7</sup> / <sub>8</sub>	1067 x 457 x 683	RID__-184227LF2	1,695
36 x 18 x 26 <sup>7</sup> / <sub>8</sub>	914 x 457 x 683	RID__-183627LF2	1,428
30 x 18 x 26 <sup>7</sup> / <sub>8</sub>	762 x 457 x 683	RID__-183027LF2	1,310

Fixed fronts (D). Specify the pull code (K, M, Z, W). Specify the accent color (A, S).

**Receding-front lateral files - integrated pulls**

The 1<sup>st</sup> drawer from the bottom has a fixed front. The 6<sup>th</sup> drawer has a receding front with a fixed shelf. In order to comply with ANSI/BIFMA, a counterweight or anchoring solution is required for files with 4 or less drawers.



6-high.

42 x 18 x 77 <sup>5</sup> / <sub>8</sub>	1067 x 457 x 1972	RIR__-184278LF6	5,152
36 x 18 x 77 <sup>5</sup> / <sub>8</sub>	914 x 457 x 1972	RIR__-183678LF6	4,651
30 x 18 x 77 <sup>5</sup> / <sub>8</sub>	762 x 457 x 1972	RIR__-183078LF6	4,617

Receding fronts (R). Specify the pull code (F, R). Specify the accent color (A, S).

5-high.

42 x 18 x 65 <sup>1</sup> / <sub>2</sub>	1067 x 457 x 1664	RIR__-184266LF5	4,267
36 x 18 x 65 <sup>1</sup> / <sub>2</sub>	914 x 457 x 1664	RIR__-183666LF5	3,674
30 x 18 x 65 <sup>1</sup> / <sub>2</sub>	762 x 457 x 1664	RIR__-183066LF5	3,608

Receding fronts (R). Specify the pull code (F, R). Specify the accent color (A, S).



4-high.

42 x 18 x 53 <sup>3</sup> / <sub>8</sub>	1067 x 457 x 1356	RIR__-184254LF4	3,534
36 x 18 x 53 <sup>3</sup> / <sub>8</sub>	914 x 457 x 1356	RIR__-183654LF4	3,058
30 x 18 x 53 <sup>3</sup> / <sub>8</sub>	762 x 457 x 1356	RIR__-183054LF4	2,840

Receding fronts (R). Specify the pull code (F, R). Specify the accent color (A, S).



3-high.

42 x 18 x 40 <sup>1</sup> / <sub>16</sub>	1067 x 457 x 1018	RIR__-184241LF3	2,738
36 x 18 x 40 <sup>1</sup> / <sub>16</sub>	914 x 457 x 1018	RIR__-183641LF3	2,453
30 x 18 x 40 <sup>1</sup> / <sub>16</sub>	762 x 457 x 1018	RIR__-183041LF3	2,428

Receding fronts (R). Specify the pull code (F, R). Specify the accent color (A, S).



2-high.

42 x 18 x 27 <sup>1</sup> / <sub>8</sub>	1067 x 457 x 708	RIR__-184228LF2	2,337
36 x 18 x 27 <sup>1</sup> / <sub>8</sub>	914 x 457 x 708	RIR__-183628LF2	1,880
30 x 18 x 27 <sup>1</sup> / <sub>8</sub>	762 x 457 x 708	RIR__-183028LF2	1,746

Receding front (R). Specify the pull code (F, R). Specify the accent color (A, S).

\*Available on file with 4 and more drawers.

**CABINETS**

**Cabinets - integrated pulls**

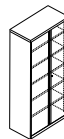

6 compartments (5 adjustable shelves).

42 x 18 x 77 <sup>5</sup> / <sub>8</sub>	1067 x 457 x 1972	RIN__-421878B	2,866
36 x 18 x 77 <sup>5</sup> / <sub>8</sub>	914 x 457 x 1972	RIN__-361878B	2,715
30 x 18 x 77 <sup>5</sup> / <sub>8</sub>	762 x 457 x 1972	RIN__-301878B	2,556

Specify the pull code (F, R). Specify the accent color (A, S).

5 compartments (4 adjustable shelves).

42 x 18 x 65 <sup>1</sup> / <sub>2</sub>	1067 x 457 x 1664	RIN__-421866B	2,370
36 x 18 x 65 <sup>1</sup> / <sub>2</sub>	914 x 457 x 1664	RIN__-361866B	2,205
30 x 18 x 65 <sup>1</sup> / <sub>2</sub>	762 x 457 x 1664	RIN__-301866B	2,121

Specify the pull code (F, R). Specify the accent color (A, S).

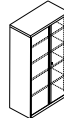

	W x D x H (in)	W x D x H (mm)	Code	Price (\$)
<b>Cabinets - integrated pulls</b> (cont'd)	<i>4 compartments (3 adjustable shelves).</i>			
	42 x 18 x 53 <sup>3</sup> / <sub>8</sub>	1067 x 457 x 1356	RIN__-421854B	2,061
	36 x 18 x 53 <sup>3</sup> / <sub>8</sub>	914 x 457 x 1356	RIN__-361854B	1,914
	30 x 18 x 53 <sup>3</sup> / <sub>8</sub>	762 x 457 x 1356	RIN__-301854B	1,837
	<b>Specify the pull code (F, R). Specify the accent color (A, S).</b>			
	<i>3 compartments (2 adjustable shelves).</i>			
	42 x 18 x 40 <sup>1</sup> / <sub>16</sub>	1067 x 457 x 1018	RIN__-421841B	1,779
	36 x 18 x 40 <sup>1</sup> / <sub>16</sub>	914 x 457 x 1018	RIN__-361841B	1,644
	30 x 18 x 40 <sup>1</sup> / <sub>16</sub>	762 x 457 x 1018	RIN__-301841B	1,577
	<b>Specify the pull code (F, R). Specify the accent color (A, S).</b>			
<i>2 compartments (1 adjustable shelf).</i>				
42 x 18 x 27 <sup>1</sup> / <sub>8</sub>	1067 x 457 x 708	RIN__-421828B	1,436	
36 x 18 x 27 <sup>1</sup> / <sub>8</sub>	914 x 457 x 708	RIN__-361828B	1,353	
30 x 18 x 27 <sup>1</sup> / <sub>8</sub>	762 x 457 x 708	RIN__-301828B	1,310	
<b>Specify the pull code (F, R). Specify the accent color (A, S).</b>				

	W x D x H (in)	W x D x H (mm)	Code	Price (\$)
<b>Cabinets - external pulls</b>	<i>6 compartments (5 adjustable shelves).</i>			
	42 x 18 x 77 <sup>3</sup> / <sub>8</sub>	1067 x 457 x 1972	RIN__-421878B	2,866
	36 x 18 x 77 <sup>3</sup> / <sub>8</sub>	914 x 457 x 1972	RIN__-361878B	2,715
	30 x 18 x 77 <sup>3</sup> / <sub>8</sub>	762 x 457 x 1972	RIN__-301878B	2,556
	<b>Specify the pull code (K, M, Z, W). Specify the accent color (A, S).</b>			
	<i>5 compartments (4 adjustable shelves).</i>			
	42 x 18 x 65 <sup>1</sup> / <sub>2</sub>	1067 x 457 x 1664	RIN__-421866B	2,370
	36 x 18 x 65 <sup>1</sup> / <sub>2</sub>	914 x 457 x 1664	RIN__-361866B	2,205
	30 x 18 x 65 <sup>1</sup> / <sub>2</sub>	762 x 457 x 1664	RIN__-301866B	2,121
	<b>Specify the pull code (K, M, Z, W). Specify the accent color (A, S).</b>			
<i>4 compartments (3 adjustable shelves).</i>				
42 x 18 x 53 <sup>3</sup> / <sub>8</sub>	1067 x 457 x 1356	RIN__-421854B	2,061	
36 x 18 x 53 <sup>3</sup> / <sub>8</sub>	914 x 457 x 1356	RIN__-361854B	1,914	
30 x 18 x 53 <sup>3</sup> / <sub>8</sub>	762 x 457 x 1356	RIN__-301854B	1,837	
<b>Specify the pull code (K, M, Z, W). Specify the accent color (A, S).</b>				
<i>3 compartments (2 adjustable shelves).</i>				
42 x 18 x 40 <sup>1</sup> / <sub>16</sub>	1067 x 457 x 1018	RIN__-421841B	1,779	
36 x 18 x 40 <sup>1</sup> / <sub>16</sub>	914 x 457 x 1018	RIN__-361841B	1,644	
30 x 18 x 40 <sup>1</sup> / <sub>16</sub>	762 x 457 x 1018	RIN__-301841B	1,577	
<b>Specify the pull code (K, M, Z, W). Specify the accent color (A, S).</b>				
<i>2 compartments (1 adjustable shelf).</i>				
42 x 18 x 27 <sup>1</sup> / <sub>8</sub>	1067 x 457 x 708	RIN__-421828B	1,436	
36 x 18 x 27 <sup>1</sup> / <sub>8</sub>	914 x 457 x 708	RIN__-361828B	1,353	
30 x 18 x 27 <sup>1</sup> / <sub>8</sub>	762 x 457 x 708	RIN__-301828B	1,310	
<b>Specify the pull code (K, M, Z, W). Specify the accent color (A, S).</b>				



<b>BOOKCASES</b>				
Bookcases	W x D x H (in)	W x D x H (mm)	Code	Price (\$)
	<i>6 compartments (5 adjustable shelves).</i>			
	42 x 18 x 77 <sup>3</sup> / <sub>8</sub>	1067 x 457 x 1972	RINNN-B427818	2,397
	36 x 18 x 77 <sup>3</sup> / <sub>8</sub>	914 x 457 x 1972	RINNN-B367818	2,220
	30 x 18 x 77 <sup>3</sup> / <sub>8</sub>	762 x 457 x 1972	RINNN-B307818	2,094
	<i>5 compartments (4 adjustable shelves).</i>			
	42 x 18 x 65 <sup>1</sup> / <sub>2</sub>	1067 x 457 x 1664	RINNN-B426618	1,895
	36 x 18 x 65 <sup>1</sup> / <sub>2</sub>	914 x 457 x 1664	RINNN-B366618	1,629
	30 x 18 x 65 <sup>1</sup> / <sub>2</sub>	762 x 457 x 1664	RINNN-B306618	1,520
	<i>4 compartments (3 adjustable shelves).</i>			
	42 x 18 x 53 <sup>3</sup> / <sub>8</sub>	1067 x 457 x 1356	RINNN-B425418	1,511
36 x 18 x 53 <sup>3</sup> / <sub>8</sub>	914 x 457 x 1356	RINNN-B365418	1,403	
30 x 18 x 53 <sup>3</sup> / <sub>8</sub>	762 x 457 x 1356	RINNN-B305418	1,302	

	W x D x H (in)	W x D x H (mm)	Code	Price (\$)
<b>Bookcases</b> (cont'd)	<i>3 compartments (2 adjustable shelves).</i>			
	42 x 18 x 40 <sup>1</sup> / <sub>16</sub>	1067 x 457 x 1018	RINNN-B424118	1,270
	36 x 18 x 40 <sup>1</sup> / <sub>16</sub>	914 x 457 x 1018	RINNN-B364118	1,137
	30 x 18 x 40 <sup>1</sup> / <sub>16</sub>	762 x 457 x 1018	RINNN-B304118	1,067
	<i>2 compartments (1 adjustable shelf).</i>			
	42 x 18 x 27 <sup>1</sup> / <sub>8</sub>	1067 x 457 x 708	RINNN-B422818	1,087
	36 x 18 x 27 <sup>1</sup> / <sub>8</sub>	914 x 457 x 708	RINNN-B362818	1,000
	30 x 18 x 27 <sup>1</sup> / <sub>8</sub>	762 x 457 x 708	RINNN-B302818	961

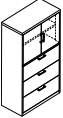
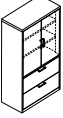
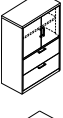

<b>WARDROBES</b>				
Wardrobes - integrated pulls	W x D x H (in)	W x D x H (mm)	Code	Price (\$)
	<i>18" (457 mm) wide.</i>			
	18 x 24 x 65 <sup>1</sup> / <sub>2</sub>	457 x 610 x 1664	RIN__-241866B	1,988
	18 x 24 x 53 <sup>3</sup> / <sub>8</sub>	457 x 610 x 1356	RIN__-241854B	1,820
	<b>Specify the pull code (F, R). Specify the accent color (A, S). Specify the door opening at the end of the code: hinges on left (L) or hinges on right (R).</b>			
	<i>15" (381 mm) wide.</i>			
	15 x 24 x 65 <sup>1</sup> / <sub>2</sub>	381 x 610 x 1664	RIN__-241566B	1,704
	15 x 24 x 53 <sup>3</sup> / <sub>8</sub>	381 x 610 x 1356	RIN__-241554B	1,618
	<b>Specify the pull code (F, R). Specify the accent color (A, S). Specify the door opening at the end of the code: hinges on left (L) or hinges on right (R).</b>			
	<i>18" (457 mm) wide.</i>			
	18 x 24 x 65 <sup>1</sup> / <sub>2</sub>	457 x 610 x 1664	RIN__-241866B	1,988
18 x 24 x 53 <sup>3</sup> / <sub>8</sub>	457 x 610 x 1356	RIN__-241854B	1,820	
<b>Specify the pull code (K, M, Z, W). Specify the accent color (A, S). Specify the door opening at the end of the code: hinges on left (L) or hinges on right (R).</b>				
<i>15" (381 mm) wide.</i>				
15 x 24 x 65 <sup>1</sup> / <sub>2</sub>	381 x 610 x 1664	RIN__-241566B	1,704	
15 x 24 x 53 <sup>3</sup> / <sub>8</sub>	381 x 610 x 1356	RIN__-241554B	1,618	
<b>Specify the pull code (K, M, Z, W). Specify the accent color (A, S). Specify the door opening at the end of the code: hinges on left (L) or hinges on right (R).</b>				

<b>MULTIFUNCTION STORAGE FURNITURE</b>				
Cabinets / Lateral Files Combos - integrated pulls	W x D x H (in)	W x D x H (mm)	Code	Price (\$)
	<i>In order to comply with ANSI/BIFMA standards, a counterweight or anchoring solution is required on storage units 53<sup>3</sup>/<sub>8</sub>" H (1356 mm) or less.</i>			
	<i>3 full width drawers, closed cabinet 23" H (584 mm) with 1 adjustable shelf.</i>			
	42 x 18 x 65 <sup>1</sup> / <sub>2</sub>	1067 x 457 x 1664	RID__-184266LF3B	4,200
	36 x 18 x 65 <sup>1</sup> / <sub>2</sub>	914 x 457 x 1664	RID__-183666LF3B	3,699
	30 x 18 x 65 <sup>1</sup> / <sub>2</sub>	762 x 457 x 1664	RID__-183066LF3B	3,623
	<b>Fixed fronts (D). Specify the pull code (F, R). Specify the accent color (A, S).</b>			
	<i>2 full width drawers, closed cabinet 35" H (889 mm) with 2 adjustable shelves.</i>			
	42 x 18 x 65 <sup>1</sup> / <sub>2</sub>	1067 x 457 x 1664	RID__-184266LF2B	3,933
	36 x 18 x 65 <sup>1</sup> / <sub>2</sub>	914 x 457 x 1664	RID__-183666LF2B	3,507
	30 x 18 x 65 <sup>1</sup> / <sub>2</sub>	762 x 457 x 1664	RID__-183066LF2B	3,342
<b>Fixed fronts (D). Specify the pull code (F, R). Specify the accent color (A, S).</b>				
<i>2 full width drawers, closed cabinet 23" H (584 mm) with 1 adjustable shelf.</i>				
42 x 18 x 53 <sup>3</sup> / <sub>8</sub>	1067 x 457 x 1356	RID__-184254LF2B	3,557	
36 x 18 x 53 <sup>3</sup> / <sub>8</sub>	914 x 457 x 1356	RID__-183654LF2B	3,174	
30 x 18 x 53 <sup>3</sup> / <sub>8</sub>	762 x 457 x 1356	RID__-183054LF2B	3,098	
<b>Fixed fronts (D). Specify the pull code (F, R). Specify the accent color (A, S).</b>				
<i>1 full width drawer, closed cabinet 23" H (584 mm) with 1 adjustable shelf.</i>				
42 x 18 x 40 <sup>1</sup> / <sub>16</sub>	1067 x 457 x 1018	RID__-184241LFB	3,391	
36 x 18 x 40 <sup>1</sup> / <sub>16</sub>	914 x 457 x 1018	RID__-183641LFB	2,888	
30 x 18 x 40 <sup>1</sup> / <sub>16</sub>	762 x 457 x 1018	RID__-183041LFB	2,814	
<b>Fixed fronts (D). Specify the pull code (F, R). Specify the accent color (A, S).</b>				

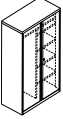

# METAL STORAGE FURNITURE

	W x D x H (in)	W x D x H (mm)	Code	Price (\$)
<b>Cabinets / Lateral Files Combos - external pulls</b>				
<i>In order to comply with ANSI/BIFMA standards, a counterweight or anchoring solution is required on storage units 53 3/8" H (1356 mm) or less.</i>				
<i>3 full width drawers, closed cabinet 23" H (584 mm) with 1 adjustable shelf.</i>				
	42 x 18 x 65 1/2	1067 x 457 x 1664	RID__-184266LF3B	4,200
	36 x 18 x 65 1/2	914 x 457 x 1664	RID__-183666LF3B	3,699
	30 x 18 x 65 1/2	762 x 457 x 1664	RID__-183066LF3B	3,623
<b>Fixed fronts (D). Specify the pull code (K, M, Z, W). Specify the accent color (A, S).</b>				
<i>2 full width drawers, closed cabinet 35" H (889 mm) with 2 adjustable shelves.</i>				
	42 x 18 x 65 1/2	1067 x 457 x 1664	RID__-184266LF2B	3,933
	36 x 18 x 65 1/2	914 x 457 x 1664	RID__-183666LF2B	3,507
	30 x 18 x 65 1/2	762 x 457 x 1664	RID__-183066LF2B	3,342
<b>Fixed fronts (D). Specify the pull code (K, M, Z, W). Specify the accent color (A, S).</b>				
<i>2 full width drawers, closed cabinet 23" H (584 mm) with 1 adjustable shelf.</i>				
	42 x 18 x 53 3/8	1067 x 457 x 1356	RID__-184254LF2B	3,557
	36 x 18 x 53 3/8	914 x 457 x 1356	RID__-183654LF2B	3,174
	30 x 18 x 53 3/8	762 x 457 x 1356	RID__-183054LF2B	3,098
<b>Fixed fronts (D). Specify the pull code (K, M, Z, W). Specify the accent color (A, S).</b>				
<i>1 full width drawer, closed cabinet 23" H (584 mm) with 1 adjustable shelf.</i>				
	42 x 18 x 40 7/16	1067 x 457 x 1018	RID__-184241LFB	3,391
	36 x 18 x 40 7/16	914 x 457 x 1018	RID__-183641LFB	2,888
	30 x 18 x 40 7/16	762 x 457 x 1018	RID__-183041LFB	2,831
<b>Fixed fronts (D). Specify the pull code (K, M, Z, W). Specify the accent color (A, S).</b>				

Counterweight option (W): add \$292.

<b>Cabinets / Wardrobes Combos - integrated pulls</b>				
<i>1 full width fixed shelf, 1 clothes hanger bar, 4 adjustable half shelves.</i>				
	42 x 18 x 77 3/8	1067 x 457 x 1972	RIN__-421878BC	3,391
	36 x 18 x 77 3/8	914 x 457 x 1972	RIN__-361878BC	3,199
	30 x 18 x 77 3/8	762 x 457 x 1972	RIN__-301878BC	3,121
<b>Specify the pull code (F, R). Specify the accent color (A, S).</b>				
<i>1 full width fixed shelf, 1 clothes hanger bar, 3 adjustable half shelves.</i>				
	42 x 18 x 65 1/2	1067 x 457 x 1664	RIN__-421866BC	3,292
	36 x 18 x 65 1/2	914 x 457 x 1664	RIN__-361866BC	3,121
	30 x 18 x 65 1/2	762 x 457 x 1664	RIN__-301866BC	3,072
<b>Specify the pull code (F, R). Specify the accent color (A, S).</b>				

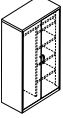
Electronic lock option (D): add \$702.

<b>Cabinets / Wardrobes Combos - external pulls</b>				
<i>1 full width fixed shelf, 1 clothes hanger bar, 4 adjustable half shelves.</i>				
	42 x 18 x 77 3/8	1067 x 457 x 1972	RIN__-421878BC	3,391
	36 x 18 x 77 3/8	914 x 457 x 1972	RIN__-361878BC	3,199
	30 x 18 x 77 3/8	762 x 457 x 1972	RIN__-301878BC	3,121
<b>Specify the pull code (K, M, Z, W). Specify the accent color (A, S).</b>				
<i>1 full width fixed shelf, 1 clothes hanger bar, 3 adjustable half shelves.</i>				
	42 x 18 x 65 1/2	1067 x 457 x 1664	RIN__-421866BC	3,292
	36 x 18 x 65 1/2	914 x 457 x 1664	RIN__-361866BC	3,121
	30 x 18 x 65 1/2	762 x 457 x 1664	RIN__-301866BC	3,072
<b>Specify the pull code (K, M, Z, W). Specify the accent color (A, S).</b>				

Electronic lock option (D): add \$702.

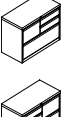
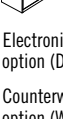
<b>Multifunction files - integrated pulls</b>				
<i>In order to comply with ANSI/BIFMA standards, a counterweight or anchoring solution is required.</i>				
<i>1 full width file drawer, 1 file drawer on left, 2 box drawers on right.</i>				
	42 x 18 x 27 1/8	1067 x 457 x 708	RID__-C0184228	2,581
	36 x 18 x 27 1/8	914 x 457 x 708	RID__-C0183628	2,363
	30 x 18 x 27 1/8	762 x 457 x 708	RID__-C0183028	2,311
<b>Fixed fronts (D). Specify the pull code (F, R). Specify the accent color (A, S).</b>				
<i>1 full width file drawer, 1 file drawer on right, 2 box drawers on left.</i>				
	42 x 18 x 27 1/8	1067 x 457 x 708	RID__-184228CO	2,581
	36 x 18 x 27 1/8	914 x 457 x 708	RID__-183628CO	2,363
	30 x 18 x 27 1/8	762 x 457 x 708	RID__-183028CO	2,311
<b>Fixed fronts (D). Specify the pull code (F, R). Specify the accent color (A, S).</b>				

Electronic lock option (D): add \$702.

Counterweight option (W): add \$292.

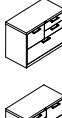
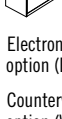
	W x D x H (in)	W x D x H (mm)	Code	Price (\$)
<b>Multifunction files - external pulls</b>				
<i>In order to comply with ANSI/BIFMA standards, a counterweight or anchoring solution is required on storage units.</i>				
<i>1 full width file drawer, 1 file drawer on left, 2 box drawers on right.</i>				
	42 x 18 x 27 1/8	1067 x 457 x 708	RID__-C0184228	2,581
	36 x 18 x 27 1/8	914 x 457 x 708	RID__-C0183628	2,363
	30 x 18 x 27 1/8	762 x 457 x 708	RID__-C0183028	2,311
<b>Fixed fronts (D). Specify the pull code (K, M, Z, W). Specify the accent color (A, S).</b>				
<i>1 full width file drawer, 1 file drawer on right, 2 box drawers on left.</i>				
	42 x 18 x 27 1/8	1067 x 457 x 708	RID__-184228CO	2,581
	36 x 18 x 27 1/8	914 x 457 x 708	RID__-183628CO	2,363
	30 x 18 x 27 1/8	762 x 457 x 708	RID__-183028CO	2,311
<b>Fixed fronts (D). Specify the pull code (K, M, Z, W). Specify the accent color (A, S).</b>				

Electronic lock option (D): add \$702.

Counterweight option (W): add \$292.

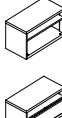
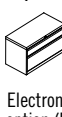
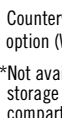
<b>Low storage units - integrated pulls</b>				
<i>In order to comply with ANSI/BIFMA standards, a counterweight or anchoring solution is required on storage units with drawer(s).</i>				
<i>1 bookcase compartment, 1 pigeonhole.</i>				
	36 x 18 x 21 3/4	914 x 457 x 552	RINN- BE361822	1,020
	30 x 18 x 21 3/4	762 x 457 x 552	RINN- BE301822	936
<b>Fixed fronts (D). Specify the pull code (F, R). Specify the accent color (A, S).</b>				
<i>1 fixed-front file drawer, 1 pigeonhole.</i>				
	36 x 18 x 21 3/4	914 x 457 x 552	RID__-SLF361822	1,595
	30 x 18 x 21 3/4	762 x 457 x 552	RID__-SLF301822	1,537
<b>Fixed front (D). Specify the pull code (F, R). Specify the accent color (A, S).</b>				
<i>1 file drawer, 1 fixed-front utility drawer.</i>				
	36 x 18 x 21 3/4	914 x 457 x 552	RID__-UL361822	1,704
	30 x 18 x 21 3/4	762 x 457 x 552	RID__-UL301822	1,644
<b>Fixed fronts (D). Specify the pull code (F, R). Specify the accent color (A, S).</b>				

Electronic lock option (D)\*: add \$702

Counterweight option (W)\*: add \$292.

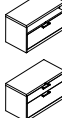
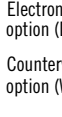

\*Not available on low storage units with open compartments.

<b>Low storage units - external pulls</b>				
<i>In order to comply with ANSI/BIFMA standards, a counterweight or anchoring solution is required.</i>				
<i>1 fixed-front file drawer, 1 pigeonhole.</i>				
	36 x 18 x 21 3/4	914 x 457 x 552	RID__-SLF361822	1,595
	30 x 18 x 21 3/4	762 x 457 x 552	RID__-SLF301822	1,537
<b>Fixed front (D). Specify the pull code (K, M, Z, W). Specify the accent color (A, S).</b>				
<i>1 file drawer and 1 fixed-front utility drawer.</i>				
	36 x 18 x 21 3/4	914 x 457 x 552	RID__-UL361822	1,704
	30 x 18 x 21 3/4	762 x 457 x 552	RID__-UL301822	1,644
<b>Fixed fronts (D). Specify the pull code (K, M, Z, W). Specify the accent color (A, S).</b>				

Electronic lock option (D): add \$702.

Counterweight option (W): add \$292.

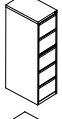
## VERTICAL FILES

<b>Vertical files - integrated pulls</b>				
<i>In order to comply with ANSI/BIFMA standards, a counterweight or anchoring solution is required on files with 3 or less drawers.</i>				
<i>5-high.</i>				
	17 3/4 x 28 x 65 1/2	451 x 711 x 1664	RID__-281866VF5	2,606
	14 3/4 x 28 x 65 1/2	375 x 711 x 1664	RID__-281566VF5	2,606
<b>Specify the pull code (F, R). Specify the accent color (A, S).</b>				
<i>4-high.</i>				
	17 3/4 x 28 x 53 3/8	451 x 711 x 1356	RID__-281854VF4	2,087
	14 3/4 x 28 x 53 3/8	375 x 711 x 1356	RID__-281554VF4	2,087
<b>Specify the pull code (F, R). Specify the accent color (A, S).</b>				

	W x D x H (in)	W x D x H (mm)	Code	Price (\$)
<b>Vertical files - integrated pulls</b> (cont'd)	<i>3-high.</i>			
	17 <sup>3</sup> / <sub>4</sub> x 28 x 40 <sup>1</sup> / <sub>16</sub>	451 x 711 x 1018	RID__-281841VF3	1,828
	14 <sup>3</sup> / <sub>4</sub> x 28 x 40 <sup>1</sup> / <sub>16</sub>	375 x 711 x 1018	RID__-281541VF3	1,828
	<b>Specify the pull code (F, R). Specify the accent color (A, S).</b>			
	<i>2-high.</i>			
	17 <sup>3</sup> / <sub>4</sub> x 28 x 27 <sup>7</sup> / <sub>8</sub>	451 x 711 x 708	RID__-281828VF2	1,310
	14 <sup>3</sup> / <sub>4</sub> x 28 x 27 <sup>7</sup> / <sub>8</sub>	375 x 711 x 708	RID__-281528VF2	1,310
	<b>Specify the pull code (F, R). Specify the accent color (A, S).</b>			



Electronic lock option (D): add \$702.

Counterweight option (W): add \$292.

	<i>In order to comply with ANSI/BIFMA standards, a counterweight or anchoring solution is required on files with 3 or less drawers.</i>			
<b>Vertical files - external pulls</b>	<i>5-high.</i>			
	17 <sup>3</sup> / <sub>4</sub> x 28 x 65 <sup>1</sup> / <sub>2</sub>	451 x 711 x 1664	RID__-281866VF5	2,606
	14 <sup>3</sup> / <sub>4</sub> x 28 x 65 <sup>1</sup> / <sub>2</sub>	375 x 711 x 1664	RID__-281566VF5	2,606
	<b>Specify the pull code (K, M, Z, W). Specify the accent color (A, S).</b>			
	<i>4-high.</i>			
	17 <sup>3</sup> / <sub>4</sub> x 28 x 53 <sup>3</sup> / <sub>8</sub>	451 x 711 x 1356	RID__-281854VF4	2,087
	14 <sup>3</sup> / <sub>4</sub> x 28 x 53 <sup>3</sup> / <sub>8</sub>	375 x 711 x 1356	RID__-281554VF4	2,087
	<b>Specify the pull code (K, M, Z, W). Specify the accent color (A, S).</b>			
	<i>3-high.</i>			
	17 <sup>3</sup> / <sub>4</sub> x 28 x 40 <sup>1</sup> / <sub>16</sub>	451 x 711 x 1018	RID__-281841VF3	1,828
	14 <sup>3</sup> / <sub>4</sub> x 28 x 40 <sup>1</sup> / <sub>16</sub>	375 x 711 x 1018	RID__-281541VF3	1,828
	<b>Specify the pull code (K, M, Z, W). Specify the accent color (A, S).</b>			
	<i>2-high.</i>			
	17 <sup>3</sup> / <sub>4</sub> x 28 x 27 <sup>7</sup> / <sub>8</sub>	451 x 711 x 708	RID__-281828VF2	1,310
	14 <sup>3</sup> / <sub>4</sub> x 28 x 27 <sup>7</sup> / <sub>8</sub>	375 x 711 x 708	RID__-281528VF2	1,310
	<b>Specify the pull code (K, M, Z, W). Specify the accent color (A, S).</b>			

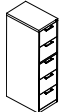

Electronic lock option (D): add \$702.

Counterweight option (W): add \$292.

**LAMINATE TOPS**

Double-faced tape included. When appropriately mounted, back-to-back tops (units with two or more drawers) or side-by-side tops (units with 3 or more drawers) are an efficient alternative to the use of counterweights.

<b>Tops for individual storage unit</b>	<i>Top 1" (25 mm) thick.</i>			
	42 <sup>1</sup> / <sub>16</sub> x 18 <sup>1</sup> / <sub>16</sub> x 1	1068 x 458 x 25	R_NNN-T04218	359 484
	36 <sup>1</sup> / <sub>16</sub> x 18 <sup>1</sup> / <sub>16</sub> x 1	916 x 458 x 25	R_NNN-T03618	342 443
	30 <sup>1</sup> / <sub>16</sub> x 18 <sup>1</sup> / <sub>16</sub> x 1	763 x 458 x 25	R_NNN-T03018	327 426
	<b>Specify the finish (1, 2). Smooth edge (N).</b>			
	<i>Top 1 1/2" (38 mm) thick.</i>			
	42 <sup>1</sup> / <sub>16</sub> x 18 <sup>1</sup> / <sub>16</sub> x 1 1/2	1068 x 458 x 38	R_NNN-T04218	484 618
	36 <sup>1</sup> / <sub>16</sub> x 18 <sup>1</sup> / <sub>16</sub> x 1 1/2	916 x 458 x 38	R_NNN-T03618	468 551
	30 <sup>1</sup> / <sub>16</sub> x 18 <sup>1</sup> / <sub>16</sub> x 1 1/2	763 x 458 x 38	R_NNN-T03018	450 518
	<b>Specify the finish (5, 6). Smooth edge (N).</b>			

<b>Tops for 2 side-by-side storage units</b>	<i>Top 1" (25 mm) thick.</i>			
	84 <sup>1</sup> / <sub>8</sub> x 18 <sup>1</sup> / <sub>16</sub> x 1	2136 x 458 x 25	R_NNN-T08418	484 669
	72 <sup>1</sup> / <sub>8</sub> x 18 <sup>1</sup> / <sub>16</sub> x 1	1832 x 458 x 25	R_NNN-T07218	443 618
	60 <sup>1</sup> / <sub>8</sub> x 18 <sup>1</sup> / <sub>16</sub> x 1	1526 x 458 x 25	R_NNN-T06018	410 567
	<b>Specify the finish (1, 2). Smooth edge (N).</b>			
	<i>Top 1 1/2" (38 mm) thick.</i>			
	84 <sup>1</sup> / <sub>8</sub> x 18 <sup>1</sup> / <sub>16</sub> x 1 1/2	2136 x 458 x 38	R_NNN-T08418	669 861
	72 <sup>1</sup> / <sub>8</sub> x 18 <sup>1</sup> / <sub>16</sub> x 1 1/2	1832 x 458 x 38	R_NNN-T07218	618 769
	60 <sup>1</sup> / <sub>8</sub> x 18 <sup>1</sup> / <sub>16</sub> x 1 1/2	1526 x 458 x 38	R_NNN-T06018	567 720
	<b>Specify the finish (5, 6). Smooth edge (N).</b>			

<b>Tops for 2 back-to-back storage units.</b>	<i>Top 1" (25 mm) thick.</i>			
	42 <sup>1</sup> / <sub>16</sub> x 36 <sup>1</sup> / <sub>8</sub> x 1	1068 x 916 x 25	R_NNN-T04236	443 643
	36 <sup>1</sup> / <sub>16</sub> x 36 <sup>1</sup> / <sub>8</sub> x 1	916 x 916 x 25	R_NNN-T03636	426 586
	30 <sup>1</sup> / <sub>16</sub> x 36 <sup>1</sup> / <sub>8</sub> x 1	763 x 916 x 25	R_NNN-T03036	393 518
	<b>Specify the finish (1, 2). Smooth edge (N).</b>			



	W x D x H (in)	W x D x H (mm)	Code	Dessus melamine (\$)	Dessus stratifié (\$)
<b>Tops for 2 back-to-back storage units.</b> (cont'd)	<i>Top 1 1/2" (38 mm) thick.</i>				
	42 <sup>1</sup> / <sub>16</sub> x 36 <sup>1</sup> / <sub>8</sub> x 1 1/2	1068 x 916 x 38	R_NNN-T04236	618	752
	36 <sup>1</sup> / <sub>16</sub> x 36 <sup>1</sup> / <sub>8</sub> x 1 1/2	916 x 916 x 38	R_NNN-T03636	601	676
	30 <sup>1</sup> / <sub>16</sub> x 36 <sup>1</sup> / <sub>8</sub> x 1 1/2	763 x 916 x 38	R_NNN-T03036	536	618
	<b>Specify the finish (5, 6). Smooth edge (N).</b>				

<b>Tops for 4 back-to-back storage units</b>	<i>Top 1" (25 mm) thick.</i>				
	84 <sup>1</sup> / <sub>8</sub> x 36 <sup>1</sup> / <sub>8</sub> x 1	2136 x 916 x 25	R_NNN-T08436	969	1,336
	72 <sup>1</sup> / <sub>8</sub> x 36 <sup>1</sup> / <sub>8</sub> x 1	1832 x 916 x 25	R_NNN-T07236	883	1,236
	60 <sup>1</sup> / <sub>8</sub> x 36 <sup>1</sup> / <sub>8</sub> x 1	1526 x 916 x 25	R_NNN-T06036	817	1,137
	<b>Specify the finish (1, 2). Smooth edge (N).</b>				

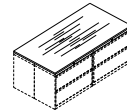

	<i>Top 1 1/2" (38 mm) thick.</i>				
	84 <sup>1</sup> / <sub>8</sub> x 36 <sup>1</sup> / <sub>8</sub> x 1 1/2	2136 x 916 x 38	R_NNN-T08436	1,336	1,721
	72 <sup>1</sup> / <sub>8</sub> x 36 <sup>1</sup> / <sub>8</sub> x 1 1/2	1832 x 916 x 38	R_NNN-T07236	1,236	1,537
	60 <sup>1</sup> / <sub>8</sub> x 36 <sup>1</sup> / <sub>8</sub> x 1 1/2	1526 x 916 x 38	R_NNN-T06036	1,137	1,436
	<b>Specify the finish (5, 6). Smooth edge (N).</b>				

<b>Tops for individual storage unit - 24" D</b>	<i>Top 1" (25 mm) thick.</i>				
	18 <sup>1</sup> / <sub>16</sub> x 24 <sup>1</sup> / <sub>16</sub> x 1	458 x 611 x 25	R_NNN-T01824	283	366
	15 <sup>1</sup> / <sub>16</sub> x 24 <sup>1</sup> / <sub>16</sub> x 1	382 x 611 x 25	R_NNN-T01524	270	342
	<b>Specify the finish (1, 2). Smooth edge (N).</b>				



	<i>Top 1 1/2" (38 mm) thick.</i>				
	18 <sup>1</sup> / <sub>16</sub> x 24 <sup>1</sup> / <sub>16</sub> x 1 1/2	458 x 611 x 38	R_NNN-T01824	393	468
	15 <sup>1</sup> / <sub>16</sub> x 24 <sup>1</sup> / <sub>16</sub> x 1 1/2	382 x 611 x 38	R_NNN-T01524	366	443
	<b>Specify the finish (5, 6). Smooth edge (N).</b>				

**PEDESTALS**

<b>Fixed pedestals - integrated pulls</b>	<i>Fixed pedestals may be affixed underneath a work surface (drilling required).</i>			
	<i>2 box drawers, 1 file drawer.</i>			
	14 <sup>3</sup> / <sub>4</sub> x 28 x 27 <sup>7</sup> / <sub>8</sub>	375 x 711 x 708	RID__-P1528UF	941
	14 <sup>3</sup> / <sub>4</sub> x 22 x 27 <sup>7</sup> / <sub>8</sub>	375 x 559 x 708	RID__-P1522UF	908
	14 <sup>3</sup> / <sub>4</sub> x 18 x 27 <sup>7</sup> / <sub>8</sub>	375 x 457 x 708	RID__-P1518UF	921
	<b>Specify the pull code (F, R). Specify the accent color (A, S).</b>			
	<i>2 file drawers.</i>			
	14 <sup>3</sup> / <sub>4</sub> x 28 x 27 <sup>7</sup> / <sub>8</sub>	375 x 711 x 708	RID__-P1528FF	875
	14 <sup>3</sup> / <sub>4</sub> x 22 x 27 <sup>7</sup> / <sub>8</sub>	375 x 559 x 708	RID__-P1522FF	841
	14 <sup>3</sup> / <sub>4</sub> x 18 x 27 <sup>7</sup> / <sub>8</sub>	375 x 457 x 708	RID__-P1518FF	860
	<b>Specify the pull code (F, R). Specify the accent color (A, S).</b>			





Electronic lock option (D): add \$702.



<b>Fixed pedestals - external pulls</b>	<i>Fixed pedestals may be affixed underneath a work surface (drilling required).</i>			
	<i>2 box drawers, 1 file drawer.</i>			
	14 <sup>3</sup> / <sub>4</sub> x 28 x 27 <sup>7</sup> / <sub>8</sub>	375 x 711 x 708	RID__-P1528UF	941
	14 <sup>3</sup> / <sub>4</sub> x 22 x 27 <sup>7</sup> / <sub>8</sub>	375 x 559 x 708	RID__-P1522UF	908
	14 <sup>3</sup> / <sub>4</sub> x 18 x 27 <sup>7</sup> / <sub>8</sub>	375 x 457 x 708	RID__-P1518UF	921
	<b>Specify the pull code (K, M, Z, W). Specify the accent color (A, S).</b>			
	<i>2 file drawers.</i>			
	14 <sup>3</sup> / <sub>4</sub> x 28 x 27 <sup>7</sup> / <sub>8</sub>	375 x 711 x 708	RID__-P1528FF	875
	14 <sup>3</sup> / <sub>4</sub> x 22 x 27 <sup>7</sup> / <sub>8</sub>	375 x 559 x 708	RID__-P1522FF	841
	14 <sup>3</sup> / <sub>4</sub> x 18 x 27 <sup>7</sup> / <sub>8</sub>	375 x 457 x 708	RID__-P1518FF	860
	<b>Specify the pull code (K, M, Z, W). Specify the accent color (A, S).</b>			



Electronic lock option (D): add \$702.

# METAL STORAGE FURNITURE

	W x D x H (in)	W x D x H (mm)	Code	Price (\$)
<b>Mobile pedestals - integrated pulls</b>	<i>Black casters.</i>			
	<i>2 box drawers, 1 file drawer.</i>			
	14 <sup>3</sup> / <sub>4</sub> x 28 x 26 <sup>1</sup> / <sub>2</sub>	375 x 711 x 673	RID__-MP1528UF	1,025
	14 <sup>3</sup> / <sub>4</sub> x 22 x 26 <sup>1</sup> / <sub>2</sub>	375 x 559 x 673	RID__-MP1522UF	991
14 <sup>3</sup> / <sub>4</sub> x 18 x 26 <sup>1</sup> / <sub>2</sub>	375 x 457 x 673	RID__-MP1518UF	1,010	
	<b>Specify the pull code (F, R). Specify the accent color (A, S).</b>			
	<i>2 file drawers.</i>			
	14 <sup>3</sup> / <sub>4</sub> x 28 x 26 <sup>1</sup> / <sub>2</sub>	375 x 711 x 673	RID__-MP1528FF	961
	14 <sup>3</sup> / <sub>4</sub> x 22 x 26 <sup>1</sup> / <sub>2</sub>	375 x 559 x 673	RID__-MP1522FF	928
	14 <sup>3</sup> / <sub>4</sub> x 18 x 26 <sup>1</sup> / <sub>2</sub>	375 x 457 x 673	RID__-MP1518FF	947
	<b>Specify the pull code (F, R). Specify the accent color (A, S).</b>			
	<i>1 box drawer, 1 file drawer. Can accommodate a RINNN-CU15_____ cushion.</i>			
	14 <sup>3</sup> / <sub>4</sub> x 28 x 20 <sup>7</sup> / <sub>8</sub>	375 x 711 x 530	RID__-MP1528F	892
	14 <sup>3</sup> / <sub>4</sub> x 22 x 20 <sup>7</sup> / <sub>8</sub>	375 x 559 x 530	RID__-MP1522F	861
	14 <sup>3</sup> / <sub>4</sub> x 18 x 20 <sup>7</sup> / <sub>8</sub>	375 x 457 x 530	RID__-MP1518F	878
	<b>Specify the pull code (F, R). Specify the accent color (A, S).</b>			



<b>Mobile pedestals - external pulls</b>	<i>Black casters.</i>			
	<i>2 box drawers, 1 file drawer.</i>			
	14 <sup>3</sup> / <sub>4</sub> x 28 x 26 <sup>1</sup> / <sub>2</sub>	375 x 711 x 673	RID__-MP1528UF	1,025
	14 <sup>3</sup> / <sub>4</sub> x 22 x 26 <sup>1</sup> / <sub>2</sub>	375 x 559 x 673	RID__-MP1522UF	991
14 <sup>3</sup> / <sub>4</sub> x 18 x 26 <sup>1</sup> / <sub>2</sub>	375 x 457 x 673	RID__-MP1518UF	1,010	
	<b>Specify the pull code (K, M, Z, W). Specify the accent color (A, S).</b>			
	<i>2 file drawers.</i>			
	14 <sup>3</sup> / <sub>4</sub> x 28 x 26 <sup>1</sup> / <sub>2</sub>	375 x 711 x 673	RID__-MP1528FF	961
	14 <sup>3</sup> / <sub>4</sub> x 22 x 26 <sup>1</sup> / <sub>2</sub>	375 x 559 x 673	RID__-MP1522FF	928
	14 <sup>3</sup> / <sub>4</sub> x 18 x 26 <sup>1</sup> / <sub>2</sub>	375 x 457 x 673	RID__-MP1518FF	947
	<b>Specify the pull code (K, M, Z, W). Specify the accent color (A, S).</b>			
	<i>1 box drawer, 1 file drawer. Can accommodate a RINNN-CU15_____ cushion.</i>			
	14 <sup>3</sup> / <sub>4</sub> x 28 x 20 <sup>7</sup> / <sub>8</sub>	375 x 711 x 530	RID__-MP1528F	892
	14 <sup>3</sup> / <sub>4</sub> x 22 x 20 <sup>7</sup> / <sub>8</sub>	375 x 559 x 530	RID__-MP1522F	861
	14 <sup>3</sup> / <sub>4</sub> x 18 x 20 <sup>7</sup> / <sub>8</sub>	375 x 457 x 530	RID__-MP1518F	878
	<b>Specify the pull code (K, M, Z, W). Specify the accent color (A, S).</b>			

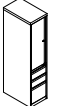
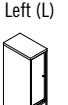

## COMBINED TOWERS

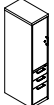
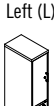

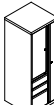
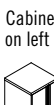
65<sup>1</sup>/<sub>2</sub>" H (1664 mm): closed cabinet or bookcase 35" H (889 mm) with 2 adjustable shelves.  
53<sup>3</sup>/<sub>8</sub>" H (1356 mm): closed cabinet or bookcase 23" H (584 mm) with 1 adjustable shelf.



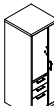
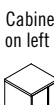

<b>Combined towers with cabinet - integrated pulls</b>	<i>1 cabinet, 2 box drawers, 1 file drawer.</i>			
	14 <sup>3</sup> / <sub>4</sub> x 24 x 65 <sup>1</sup> / <sub>2</sub>	375 x 610 x 1664	RID__-152466UFB_	2,050
	14 <sup>3</sup> / <sub>4</sub> x 24 x 53 <sup>3</sup> / <sub>8</sub>	375 x 610 x 1356	RID__-152454UFB_	1,980
	<b>Specify the pull code (F, R). Specify the accent color (A, S). Specify the door opening at the end of the code: hinges on left (L) ou hinges on right (R).</b>			
	<i>1 cabinet, 2 file drawers.</i>			
	14 <sup>3</sup> / <sub>4</sub> x 24 x 65 <sup>1</sup> / <sub>2</sub>	375 x 610 x 1664	RID__-152466FFB_	2,023
	14 <sup>3</sup> / <sub>4</sub> x 24 x 53 <sup>3</sup> / <sub>8</sub>	375 x 610 x 1356	RID__-152454FFB_	1,958
	<b>Specify the pull code (F, R). Specify the accent color (A, S). Specify the door opening at the end of the code: hinges on left (L) ou hinges on right (R).</b>			
	<i>1 cabinet, 2 box drawers, 1 file drawer, 1 wardrobe with clothes hanger bar on right.</i>			
	14 <sup>3</sup> / <sub>4</sub> x 24 x 65 <sup>1</sup> / <sub>2</sub>	375 x 610 x 1664	RID__-152466UFB_	2,050
	14 <sup>3</sup> / <sub>4</sub> x 24 x 53 <sup>3</sup> / <sub>8</sub>	375 x 610 x 1356	RID__-152454UFB_	1,980
	<b>Specify the pull code (F, R). Specify the accent color (A, S). Specify the door opening at the end of the code: hinges on left (L) ou hinges on right (R).</b>			

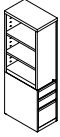
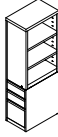
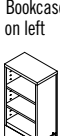
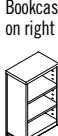

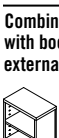
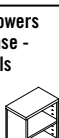

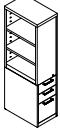
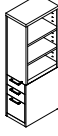
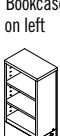
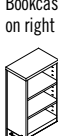
<b>Combined towers with cabinet - external pulls</b>	<i>1 cabinet, 2 box drawers, 1 file drawer.</i>			
	14 <sup>3</sup> / <sub>4</sub> x 24 x 65 <sup>1</sup> / <sub>2</sub>	375 x 610 x 1664	RID__-152466UFB_	2,050
	14 <sup>3</sup> / <sub>4</sub> x 24 x 53 <sup>3</sup> / <sub>8</sub>	375 x 610 x 1356	RID__-152454UFB_	1,980
	<b>Specify the pull code (K, M, Z, W). Specify the accent color (A, S). Specify the door opening at the end of the code: hinges on left (L) ou hinges on right (R).</b>			
	<i>1 cabinet, 2 file drawers.</i>			
	14 <sup>3</sup> / <sub>4</sub> x 24 x 65 <sup>1</sup> / <sub>2</sub>	375 x 610 x 1664	RID__-152466FFB_	2,023
	14 <sup>3</sup> / <sub>4</sub> x 24 x 53 <sup>3</sup> / <sub>8</sub>	375 x 610 x 1356	RID__-152454FFB_	1,958
	<b>Specify the pull code (K, M, Z, W). Specify the accent color (A, S). Specify the door opening at the end of the code: hinges on left (L) ou hinges on right (R).</b>			
	<i>1 cabinet, 2 box drawers, 1 file drawer, 1 wardrobe with clothes hanger bar on right.</i>			
	14 <sup>3</sup> / <sub>4</sub> x 24 x 65 <sup>1</sup> / <sub>2</sub>	375 x 610 x 1664	RID__-152466UFB_	2,050
	14 <sup>3</sup> / <sub>4</sub> x 24 x 53 <sup>3</sup> / <sub>8</sub>	375 x 610 x 1356	RID__-152454UFB_	1,980
	<b>Specify the pull code (K, M, Z, W). Specify the accent color (A, S). Specify the door opening at the end of the code: hinges on left (L) ou hinges on right (R).</b>			



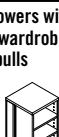

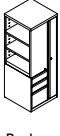
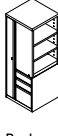
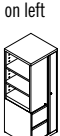
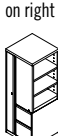
<b>Combined towers with cabinet / wardrobe - integrated pulls</b>	<i>1 cabinet on left, 2 box drawers, 1 file drawer, 1 wardrobe with clothes hanger bar on right.</i>			
	23 <sup>3</sup> / <sub>4</sub> x 24 x 65 <sup>1</sup> / <sub>2</sub>	603 x 610 x 1664	RID__-242466BUF	2,536
	23 <sup>3</sup> / <sub>4</sub> x 24 x 53 <sup>3</sup> / <sub>8</sub>	603 x 610 x 1356	RID__-242454BUF	2,467
	<b>Specify the pull code (F, R). Specify the accent color (A, S).</b>			
	<i>1 cabinet on right, 2 box drawers, 1 file drawer, 1 wardrobe with clothes hanger bar on left.</i>			
	23 <sup>3</sup> / <sub>4</sub> x 24 x 65 <sup>1</sup> / <sub>2</sub>	603 x 610 x 1664	RID__-242466UFB	2,536
	23 <sup>3</sup> / <sub>4</sub> x 24 x 53 <sup>3</sup> / <sub>8</sub>	603 x 610 x 1356	RID__-242454UFB	2,467
	<b>Specify the pull code (F, R). Specify the accent color (A, S).</b>			
	<i>1 cabinet on left, 2 file drawers, 1 wardrobe with clothes hanger bar on right.</i>			
	23 <sup>3</sup> / <sub>4</sub> x 24 x 65 <sup>1</sup> / <sub>2</sub>	603 x 610 x 1664	RID__-242466BFF	2,500
	23 <sup>3</sup> / <sub>4</sub> x 24 x 53 <sup>3</sup> / <sub>8</sub>	603 x 610 x 1356	RID__-242454BFF	2,434
	<b>Specify the pull code (F, R). Specify the accent color (A, S).</b>			
	<i>1 cabinet on right, 2 file drawers, 1 wardrobe with clothes hanger bar on left.</i>			
	23 <sup>3</sup> / <sub>4</sub> x 24 x 65 <sup>1</sup> / <sub>2</sub>	603 x 610 x 1664	RID__-242466FFB	2,500
	23 <sup>3</sup> / <sub>4</sub> x 24 x 53 <sup>3</sup> / <sub>8</sub>	603 x 610 x 1356	RID__-242454FFB	2,434
	<b>Specify the pull code (F, R). Specify the accent color (A, S).</b>			

<b>Combined towers with cabinet / wardrobe - external pulls</b>	<i>1 cabinet on left, 2 box drawers, 1 file drawer, 1 wardrobe with clothes hanger bar on right.</i>			
	23 <sup>3</sup> / <sub>4</sub> x 24 x 65 <sup>1</sup> / <sub>2</sub>	603 x 610 x 1664	RID__-242466BUF	2,536
	23 <sup>3</sup> / <sub>4</sub> x 24 x 53 <sup>3</sup> / <sub>8</sub>	603 x 610 x 1356	RID__-242454BUF	2,467
	<b>Specify the pull code (K, M, Z, W). Specify the accent color (A, S).</b>			
	<i>1 cabinet on right, 2 box drawers, 1 file drawer, 1 wardrobe with clothes hanger bar on left.</i>			
	23 <sup>3</sup> / <sub>4</sub> x 24 x 65 <sup>1</sup> / <sub>2</sub>	603 x 610 x 1664	RID__-242466UFB	2,536
	23 <sup>3</sup> / <sub>4</sub> x 24 x 53 <sup>3</sup> / <sub>8</sub>	603 x 610 x 1356	RID__-242454UFB	2,467
	<b>Specify the pull code (K, M, Z, W). Specify the accent color (A, S).</b>			
	<i>1 cabinet on left, 2 file drawers, 1 wardrobe with clothes hanger bar on right.</i>			
	23 <sup>3</sup> / <sub>4</sub> x 24 x 65 <sup>1</sup> / <sub>2</sub>	603 x 610 x 1664	RID__-242466BFF	2,500
	23 <sup>3</sup> / <sub>4</sub> x 24 x 53 <sup>3</sup> / <sub>8</sub>	603 x 610 x 1356	RID__-242454BFF	2,434
	<b>Specify the pull code (K, M, Z, W). Specify the accent color (A, S).</b>			
	<i>1 cabinet on right, 2 file drawers, 1 wardrobe with clothes hanger bar on left.</i>			
	23 <sup>3</sup> / <sub>4</sub> x 24 x 65 <sup>1</sup> / <sub>2</sub>	603 x 610 x 1664	RID__-242466FFB	2,500
	23 <sup>3</sup> / <sub>4</sub> x 24 x 53 <sup>3</sup> / <sub>8</sub>	603 x 610 x 1356	RID__-242454FFB	2,434
	<b>Specify the pull code (K, M, Z, W). Specify the accent color (A, S).</b>			

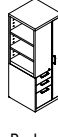
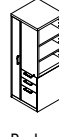
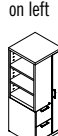

	W x D x H (in)	W x D x H (mm)	Code	Price (\$)
<b>Combined towers with bookcase</b>	<i>1 bookcase on left, 2 box drawers, 1 file drawer.</i>			
	14 3/4 x 24 x 65 1/2	375 x 610 x 1664	RID__-PUF152466	1,996
	14 3/4 x 24 x 53 3/8	375 x 610 x 1356	RID__-PUF152454	1,931
	<b>Specify the pull code (F, R). Specify the accent color (A, S).</b>			
	<i>1 bookcase on right, 2 box drawers, 1 file drawer.</i>			
	14 3/4 x 24 x 65 1/2	375 x 610 x 1664	RID__-P152466UF	1,996
	14 3/4 x 24 x 53 3/8	375 x 610 x 1356	RID__-P152454UF	1,931
	<b>Specify the pull code (F, R). Specify the accent color (A, S).</b>			
	<i>1 bookcase on left, 2 file drawers.</i>			
	14 3/4 x 24 x 65 1/2	375 x 610 x 1664	RID__-PFF152466	1,970
	14 3/4 x 24 x 53 3/8	375 x 610 x 1356	RID__-PFF152454	1,907
	<b>Specify the pull code (F, R). Specify the accent color (A, S).</b>			
	<i>1 bookcase on right, 2 file drawers.</i>			
	14 3/4 x 24 x 65 1/2	375 x 610 x 1664	RID__-P152466FF	1,970
	14 3/4 x 24 x 53 3/8	375 x 610 x 1356	RID__-P152454FF	1,907
	<b>Specify the pull code (F, R). Specify the accent color (A, S).</b>			
	Electronic lock option (D): add \$702.			

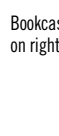
<b>Combined towers with bookcase - external pulls</b>	<i>1 bookcase on left, 2 box drawers, 1 file drawer.</i>			
	14 3/4 x 24 x 65 1/2	375 x 610 x 1664	RID__-PUF152466	1,996
	14 3/4 x 24 x 53 3/8	375 x 610 x 1356	RID__-PUF152454	1,931
	<b>Specify the pull code (K, M, Z, W). Specify the accent color (A, S).</b>			
	<i>1 bookcase on right, 2 box drawers, 1 file drawer.</i>			
	14 3/4 x 24 x 65 1/2	375 x 610 x 1664	RID__-P152466UF	1,996
	14 3/4 x 24 x 53 3/8	375 x 610 x 1356	RID__-P152454UF	1,931
	<b>Specify the pull code (K, M, Z, W). Specify the accent color (A, S).</b>			
	<i>1 bookcase on left, 2 file drawers.</i>			
	14 3/4 x 24 x 65 1/2	375 x 610 x 1664	RID__-PFF152466	1,970
	14 3/4 x 24 x 53 3/8	375 x 610 x 1356	RID__-PFF152454	1,907
	<b>Specify the pull code (K, M, Z, W). Specify the accent color (A, S).</b>			
	<i>1 bookcase on right, 2 file drawers.</i>			
	14 3/4 x 24 x 65 1/2	375 x 610 x 1664	RID__-P152466FF	1,970
	14 3/4 x 24 x 53 3/8	375 x 610 x 1356	RID__-P152454FF	1,907
	<b>Specify the pull code (K, M, Z, W). Specify the accent color (A, S).</b>			
	Electronic lock option (D): add \$702.			

<b>Combined towers with bookcase / wardrobe - integrated pulls</b>	<i>1 bookcase on left, 2 box drawers, 1 file drawer, 1 wardrobe with clothes hanger bar on right.</i>			
	23 3/4 x 24 x 65 1/2	603 x 610 x 1664	RID__-PBUF242466	2,504
	23 3/4 x 24 x 53 3/8	603 x 610 x 1356	RID__-PBUF242454	2,388
	<b>Specify the pull code (F, R). Specify the accent color (A, S).</b>			
	<i>1 bookcase on right, 2 box drawers, 1 file drawer, 1 wardrobe with clothes hanger bar on left.</i>			
	23 3/4 x 24 x 65 1/2	603 x 610 x 1664	RID__-P242466BUF	2,504
	23 3/4 x 24 x 53 3/8	603 x 610 x 1356	RID__-P242454BUF	2,388
	<b>Specify the pull code (F, R). Specify the accent color (A, S).</b>			
	<i>1 bookcase on left, 2 file drawers, 1 wardrobe with clothes hanger bar on right.</i>			
	23 3/4 x 24 x 65 1/2	603 x 610 x 1664	RID__-PBFF242466	2,422
	23 3/4 x 24 x 53 3/8	603 x 610 x 1356	RID__-PBFF242454	2,357
	<b>Specify the pull code (F, R). Specify the accent color (A, S).</b>			
	<i>1 bookcase on right, 2 file drawers, 1 wardrobe with clothes hanger bar on left.</i>			
	23 3/4 x 24 x 65 1/2	603 x 610 x 1664	RID__-P242466BFF	2,422
	23 3/4 x 24 x 53 3/8	603 x 610 x 1356	RID__-P242454BFF	2,357
	<b>Specify the pull code (F, R). Specify the accent color (A, S).</b>			

	W x D x H (in)	W x D x H (mm)	Code	Price (\$)
<b>Combined towers with bookcase / wardrobe - external pulls</b>	<i>1 bookcase on left, 2 box drawers, 1 file drawer, 1 wardrobe with clothes hanger bar on right.</i>			
	23 3/4 x 24 x 65 1/2	603 x 610 x 1664	RID__-PBUF242466	2,453
	23 3/4 x 24 x 53 3/8	603 x 610 x 1356	RID__-PBUF242454	2,388
	<b>Specify the pull code (K, M, Z, W). Specify the accent color (A, S).</b>			
	<i>1 bookcase on right, 2 box drawers, 1 file drawer, 1 wardrobe with clothes hanger bar on left.</i>			
	23 3/4 x 24 x 65 1/2	603 x 610 x 1664	RID__-P242466BUF	2,453
	23 3/4 x 24 x 53 3/8	603 x 610 x 1356	RID__-P242454BUF	2,388
	<b>Specify the pull code (K, M, Z, W). Specify the accent color (A, S).</b>			
	<i>1 bookcase on left, 2 file drawers, 1 wardrobe with clothes hanger bar on right.</i>			
	23 3/4 x 24 x 65 1/2	603 x 610 x 1664	RID__-PBFF242466	2,422
	23 3/4 x 24 x 53 3/8	603 x 610 x 1356	RID__-PBFF242454	2,357
	<b>Specify the pull code (K, M, Z, W). Specify the accent color (A, S).</b>			
	<i>1 bookcase on right, 2 file drawers, 1 wardrobe with clothes hanger bar on left.</i>			
	23 3/4 x 24 x 65 1/2	603 x 610 x 1664	RID__-P242466BFF	2,422
	23 3/4 x 24 x 53 3/8	603 x 610 x 1356	RID__-P242454BFF	2,357
	<b>Specify the pull code (K, M, Z, W). Specify the accent color (A, S).</b>			

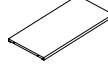
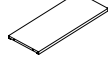
**ACCESSORIES**

<b>Additional shelves</b>	<i>Insert into the storage units lateral notches. No tool required.</i>			
	<i>For bookcases.</i>			
	41 3/4 x 16 3/4 x 3/4	1060 x 425 x 19	RINNN-TB4218	174
	35 3/4 x 16 3/4 x 3/4	908 x 425 x 19	RINNN-TB3618	167
	29 3/4 x 16 3/4 x 3/4	756 x 425 x 19	RINNN-TB3018	159
	<i>For cabinets.</i>			
	41 3/4 x 14 1/4 x 3/4	1060 x 362 x 19	RINNN-TA4218	174
	35 3/4 x 14 1/4 x 3/4	908 x 362 x 19	RINNN-TA3618	167
	29 3/4 x 14 1/4 x 3/4	756 x 362 x 19	RINNN-TA3018	159
<b>Pedestal and low storage unit cushions</b>	<i>Attaches to a mobile pedestal or on a low storage unit with velcro strip. Prices shown apply to all Grade 1 and 2 United Chair® fabrics. For other United Chair® grades, add: Grade 3: 15%, Grade 4: 20%, Grade 5: 25% and Grade 6: 30%.</i>			
	<i>For mobile pedestals.</i>			
	14 3/4 x 28 x 1 1/2	375 x 711 x 40	RINNN-CU1528	393
	14 3/4 x 22 x 1 1/2	375 x 559 x 40	RINNN-CU1522	302
	14 3/4 x 18 x 1 1/2	375 x 457 x 40	RINNN-CU1518	250
	<i>For low storage units.</i>			
	42 x 18 x 1 1/2	1067 x 457 x 40	RINNN-CU4218	450
	36 x 18 x 1 1/2	914 x 457 x 40	RINNN-CU3618	410
	30 x 18 x 1 1/2	762 x 457 x 40	RINNN-CU3018	333

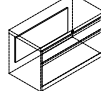
<b>Counterweights</b>	<i>Installation required. Includes counterweight and attachment brackets. Counterweight may be factory installed by adding 'W' at the end of the product code.</i>			
	<i>For vertical files with 2 or 3 drawers (VF2 to VF3):</i>			
	17 3/4" W		RINNN-CW18	316
	14 3/4" W		RINNN-CW15	302
	<i>For low storage units, multifunction files and combined lateral cabinets/files with 1 drawer (BE, SLF, CO and LFB):</i>			
	42" W		RINNN-C3W42	518
	36" W		RINNN-C3W36	476
	30" W		RINNN-C3W30	376

# METAL STORAGE FURNITURE

	W x D x H (in)	W x D x H (mm)	Code	Price (\$)
<b>Counterweights</b> (cont'd)	<i>For lateral files and combined lateral cabinets/files with 2 or 3 drawers (LF2 to LF3, LF2B and LF3B):</i>			
	42" W		<b>RINNN-C2W42</b>	<b>518</b>
	36" W		<b>RINNN-C2W36</b>	<b>434</b>
	30" W		<b>RINNN-C2W30</b>	<b>333</b>
	<i>For lateral files with 4 drawers (LF4):</i>			
	42" W		<b>RINNN-C1W42</b>	<b>333</b>
	36" W		<b>RINNN-C1W36</b>	<b>316</b>
	30" W		<b>RINNN-C1W30</b>	<b>302</b>

## Paradigm storage-to-panel attachment filler

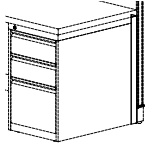

Shown: Installation on right (R)

*Attaches to the back of a metal storage unit and to an Paradigm acoustical panel in order to replace a panel bracket. May be used with any surface with 2" (50 mm) more than the depth of the metal storage furniture. Installation and drilling required.*

2 x 2 x 27<sup>7</sup>/<sub>8</sub> 50 x 50 x 708 **RINNN-EGM2\_** **171**

Specify installation on left (L) or right (R)

## Front-to-back hanging bars for lateral file drawers

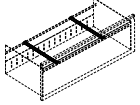

*2-bar kit. To create 2 letter or legal-size filing rows, 4 bars are needed, except for the 42" wide drawer, which needs 6 bars to create 3 letter-size filing rows. See page 4 for further information about filing capacity.*

15<sup>1</sup>/<sub>8</sub> x 1<sup>1</sup>/<sub>4</sub> x 1<sup>1</sup>/<sub>4</sub> 384 x 32 x 32 **LGC-FTB2** **55**

## Ganging kit



*Allows to attach two storage units back-to-back (2 or more drawers) or side-by-side (3 or more drawers). The mounting kit is an efficient alternative to the use of counterweights. Hole drilling required.*

**RINNN-GKIT** **66**

## Divider for lateral file drawer or low storage unit box drawer

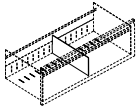

*For lateral file or low storage unit utility drawer. Inserts into the drawer slots every 1" (25 mm).*

18 x <sup>1</sup>/<sub>16</sub> x 6 457 x 2 x 152 **RINNN-DIV6** **23**

## Magnetic dividers for lateral or vertical file



*For vertical or lateral file.*

6 x 15 x 6 152 x 381 x 152 **RINNN-DIV186** **90**

6 x 12 x 6 152 x 305 x 152 **RINNN-DIV156** **90**

*For utility drawer.*

2 x 15 x 2 51 x 381 x 51 **RINNN-DIV182** **77**

2 x 12 x 2 51 x 305 x 51 **RINNN-DIV152** **77**

## Compressors

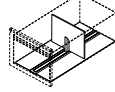

*For vertical file. Comes with a grooved drawer bottom and a bracket with a clip.*

*Letter size.* **RINNN-COM15** **116**

*Legal size.* **RINNN-COM18** **116**

## Pencil tray for box drawer

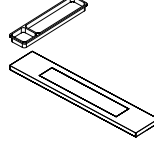

*Black plastic. Sits on the sides of a 15" W (381 mm) utility drawer and slides from front to back for drawer access.*

*Pencil tray for multifunction unit 30" W.*

12<sup>7</sup>/<sub>8</sub> x 3 x 1 327 x 76 x 25 **RINNN-PHU** **42**

*Metal tray adaptors (pencil tray sold separately).*

For multifunction unit 36" W **RINNN-PHUA18** **31**

For multifunction unit 42" W **RINNN-PHUA21** **36**

## Label holders



*Insert into the integrated pulls. Clear plastic.*

For full pull (F) **RINNN-PLHF** **8**

For recessed aluminum pull (R) **RINNN-PLHR** **8**

## Electronic locks



*Installation and hole drilling required. For further information, see electronic lock specifications, page 5.*

*For lateral or vertical file (horizontal position).*

5<sup>1</sup>/<sub>4</sub> x <sup>1</sup>/<sub>2</sub> x 1<sup>1</sup>/<sub>4</sub> 133 x 13 x 32 **RINN\_-DHLK** **302**

**Specify the accent color (A, S).**



*For cabinet or wardrobe (vertical position).*

1<sup>1</sup>/<sub>4</sub> x <sup>1</sup>/<sub>2</sub> x 5<sup>1</sup>/<sub>4</sub> 32 x 13 x 133 **RINN\_-DVUK** **302**

**Specify the accent color (A, S).**



Manager Key **RINNN-DMK** **142**

Programming Key **RINNN-DPK** **210**

## Important:

For conditions of sale, the full product offering or more information on all Lacasse collections, please consult Lacasse's General Price Book.

## Office Furniture Solutions

Founded in 1956, Groupe Lacasse is a North American leader in the design, manufacture and service of a broad range of high-quality furniture products for all types of work environments. We have the experience, expertise and capability to deliver incomparable design, exceptional quality, optimum service and outstanding value in Office Furniture Solutions.



1-888-522-2773

www.grounelacasse.com