



# '12

price list  
effective 01.01.12



**GSA Approved**  
GS-27F-0016V  
GS-27F-0017V

Goes Great with Work.®



# TABLE OF CONTENTS

## GENERAL REFERENCES

How to Order	1
Lead Times	2
Zones	3
Term and Conditions	4
Warranty	6
Quick Ship	7
Finishes	8

## VENEER CASEGOODS

Forte	10
Affirm	22
Legacy	27
Westboro	36
Inverness	41

## LAMINATE CASEGOODS

Stratus	47
Vitality	61
Elevation	70
Atlas	78
Hyperwork	100
Agility	136
Uniwork	140
2200 Series	142
Bravo Panel	151
Bedford	163
Wyndham	172
Accessories	178
Worksurface Accessories	181

## MEETING AND BREAKROOM

Workcenter	188
Milan	189
Genesis	195
Stax	197
Incognito	200
Clique Training Tables	201
Deflection Training Tables	203
Forte Tables	204
Legacy Tables	205
Vitality Tables	206
Bedford Tables	208
Atlas Tables	211
Hyperwork Tables	213
Conference Accessories	215

## HEALTHCARE

Hannah and Haley Recliners	217
Harmony Day Beds	226
Helix Dr. Stools	229
Praxis	231

## SEATING REFERENCES

FedEx Ground Shipping	237
Upholsteries	239
Leathers	243
Mayer Fabrics	245
Momentum Textiles	247
C.F. Stinson	249
Quick Ship Fabrics	250
Seating Finishes	251
Technical Bulletin #133	252
Seating Controls	253
Technical Specification	254
COM/COL worksheet	258

## OFFICE SEATING

Cirrus	260
NexStep	265
Bravado Big & Tall	269
Couger	270
Puma	271
Panther	272
Jaguar	274
Cheetah	279
Lynx	281
Leaders	282

## OFFICE SEATING (CONTINUED)

Scoop	287
1200 Series	291
Trifecta	294
Quick Silver	297
3900 Series	300

## GUEST SEATING

Contempo Armless	302
Contempo Arm Chairs	304
Accent	308
High Street	311
Hileg	314
Stacking Guest	319
Unos	321
Trados	323
Trados Metal	325

## TRADITIONAL OFFICE SEATING

Traditional Series	327
Scoop Traditional	332
Value Traditional	336

## RECEPTION/LOUNGE SEATING

Himalaya	338
Himalaya Metal	341
Eve	343
Accompany	349
Accompany Modular	352
Accompany Metal Leg	354
7300/7400	358
Steps	361
Sophia	367
Claudia	369
Lauren	371
Rebecca	372
Scarlet	373
Kimberly	374
Cassy/Natalie	376
Plaza	378
6700 Series	380
9100 Series	382
7200 Series	384
7500 Series	386
7900 Series	388
Traditional Reception	390
Chesterfield	393

## OCCASIONAL TABLES

Malibu	394
Trados Metal	395
Stratus	396
6700 Series	397
Nexstep	397
Hyperwork	398
9100 Series	398
7400 Series	399
Steps	399
Marquet	400
Bedford	401

## GANGING COLLECTION

High Street	402
Corbel	404
Scoop	406
9118/9128	408
Unos	410
Trados	411

## AUTHORIZED DEALERS ONLY

HPFI sells to authorized dealers and resellers of office furniture, and only Authorized HPFI Dealers can place orders. To become an Authorized Dealer, you must:

- Have written approval by both the local HPFI Sales Representative and HPFI Sales Management
- Establish a line of credit (or pay for all orders with certified check, Visa or Mastercard or cash prior to order entry)
- Be prepared when the factoring company that HPFI uses contacts you for credit information. Time is of the essence in supplying this data. Purchase Orders can not be entered until credit processing is completed and a line of credit is established. Allow 2 weeks for processing.

## PURCHASE ORDERS

To ensure prompt processing of your order, all purchase orders must clearly state the following:

- Dealer Name
- Purchase Order Number
- Contact Name and Phone Number
- Complete Bill To and Ship To Addresses
- Complete Product Numbers, including:
  - Model/Finish Number + Options (casegoods)
  - Model Number + Finish + Options + Upholstery Pattern/Color Number/Color Name (seating)
- Quantities

## ORDER PLACEMENT

All orders may be mailed, faxed or e-mailed to HPFI as follows:

Mail: **HPFI**  
**PO Box 2063**  
**High Point, NC 27261-2063**

Fax: **(800) 231-6784**

E-mail: **orderentry@hpfi.com**

## ORDER ENTRY

We want to process your order on a timely basis and will make every attempt to enter all orders within one business day of receipt. Inability to clearly read an order or the lack of any of the above information will delay order entry. Clarification of any missing or unclear information will be promptly requested via fax or e-mail. Once all information is received, HPFI will complete order entry.

- Your discount and net prices will be automatically calculated. **If your purchase order prices do not match HPFI calculated net prices, you will be notified via fax or e-mail. It is the customer's responsibility to review Order Acknowledgements for accuracy and pricing. Any corrections must be noted immediately and faxed or e-mailed to your Customer Service Representative at 336-434-5280.**
- Minimum order \$500 net, except parts.
- Only credit-approved orders are released to production. If an order is held due to credit reasons, you will be informed via fax or e-mail by the credit department.
- Published lead times start the first business day after entry of a clean, credit-approved order.

Choose from 2 lead time options: Quick Ship or Standard Lead Time. Lead time is measured from the date the order is entered (complete and credit-approved) to the date the order ships. Transit time is not included as it varies by carrier and destination.

## STANDARD LEAD TIME

Assigned to all orders unless the purchase order specifically requests Quick Ship **QS**. Custom features, COM upholstery and any other special product requests may increase lead time.

**Standard lead time is 3 weeks.** Orders placed to ship in standard lead times are acknowledged to ship 15 manufacturing days after the date of order entry. HPFI may elect to ship prior to the acknowledged date.

Occasionally, due to seasonal demand or holiday schedules, standard lead times may be adjusted. To verify lead time, contact your Customer Service Representative. *Hyperwork, Elevation 1" tops, Bravo Panel and Wyndham items are available with high pressure laminate tops at a 15% upcharge and a six-week lead time in the finishes listed for the individual series. See pages 70, 100, 151 and 172.*

Order Acknowledgements indicate the approximate ship date you can expect. Most orders ship complete by the indicated date. However, we cannot guarantee every order will ship by the date acknowledged. Occasionally, due to circumstances beyond our control, we may ship after the acknowledged date. We will make every effort to anticipate and inform you in advance of any late shipment situations.

## QUICK SHIP LEAD TIME – QS

HPFI offers the fastest lead-time on breadth and depth of product in the office furniture industry. Orders must be complete and credit approved to be released to production.

Quick Ship lead time is 3 manufacturing business days following the day the order is entered.

Quick Ship orders received after 1:00 p.m. Eastern Standard Time will be entered the next business day.

Casegoods Quick Ship – Casegoods product in this Price List are marked with the **QS** symbol. Only the shaded model numbers and finishes indicated as Quick Ship are available in Quick Ship lead time.

Seating Quick Ship – Most seating products are available as Quick Ship in standard finishes and Quick Ship fabrics. QS fabrics listed on page 250.

Any item ordered with installed options will not be available for Quick Ship

Quick Ship Order Must Have:

QUICK SHIP or QS clearly stated/marked on the purchase order.

Quick ship items only on the purchase order requesting QS. If there are models of QS and Standard lead times on same PO, the order will ship at standard lead-time.

Limit of 8 each of any QS item per day. QS orders exceeding the maximum for the same item cannot be ordered consecutively in the same week without prior approval from an HPFI Customer Service Representative. See QUANTITY ORDERS on page 7.

Fast Cats QS quantity is 50.

Please add additional time for holidays.



 ZONE 3

 ZONE 2

 ZONE 1

## PALLETIZATION

Casegood products ordered in LTL quantities may be palletized prior to shipment for enhanced protection and further assurance of safe delivery. Pallets are one per product, in most cases, and sized per casegood product. Seating is not palletized. Palletization is \$21 net per pallet. Add 40 lb. to ship wt. per pallet. Contact Customer Service or your Sales Representative for additional details.

International pallets are \$26.

Palletization is not generally offered on truckload quantities. Contact Customer Service for a custom quote if this option is required.

HPFI has made every effort to insure the accuracy of this Price List. HPFI cannot be responsible for typographical errors. Pricing and product specifications are subject to change and can be verified through our HPFI Customer Service Department at 800-447-3462 EXT 2120.



# TERM AND CONDITIONS



*All orders are subject to the terms and conditions presented in this price list. The term HPFI refers to High Point Furniture Industries, Inc., High Point, North Carolina - USA.*

## TERMS

Payment for all orders is due Net thirty (30) days from date of invoice.

## LEASING

Please contact HPFI Sales to learn about leasing options.

## CONDITIONS OF SALE

Possession and/or distribution of this price list or HPFI catalogs does not in itself constitute an offer to sell. Orders can be received only from authorized HPFI dealers.

Accepted orders will be acknowledged in writing with approximate shipping dates. Orders will be invoiced at prices prevailing at time of order entry.

## PRICES

This price list contains Zone pricing, including freight prepaid and allowed to the 48 contiguous states; freight and/or fuel surcharges as dictated by carriers may apply. All prices shown are suggested retail prices. Prices, specifications and materials are subject to change without notice.

## SHIPPING

All HPFI products ship as follows: **F.O.B. ORIGIN, HIGH POINT, NC - USA, FREIGHT PREPAID**—this means that ownership and the responsibility of the merchandise becomes that of the buyer upon delivery to the freight company. The zone list prices shown herein reflect the delivered price to the 48 contiguous states. It includes **dock-to-dock** shipment, with normal delivery accomplished in 3 to 10 business days, after shipment.

HPFI reserves the right to select the carrier and routing. The transportation company assumes full responsibility for safe delivery upon acceptance of the shipment from HPFI.

### Special Shipping Services:

Shipments requiring special services (such as expedited delivery, delivery appointments, non-dock, residential, school, military base or inside delivery, etc.) are not included in this freight pre-paid pricing. Freight charges for these special shipments will be quoted on a pre-pay and add, case-by-case basis. Contact Customer Service for details.

**Orders of less than 500 lbs. pounds will be assessed a minimum freight charge of \$75.00 net per order** (excluding items shipped via small package ground service). Shipments outside the USA are pre-paid to point of departure.

Acknowledged ship dates are our best estimates of when the product will leave the factory. Actual ship dates may vary.

## ORDERING

See **How To Order** pages. For clarification of any question pertaining to ordering, contact HPFI's Customer Service Department prior to placing the order.

## PACKAGING

Prices quoted herein include normal packaging. HPFI products are carefully inspected and are packed one to a carton, except where indicated. All packaging conforms to or exceeds specifications as outlined in the Uniform Freight classification. Special packing (e.g. palletization) if specified, requires an upcharge.

## DRAWER AND TOP OPTIONS

Inset drawers and thicker tops available at 20% upcharge. Contact Customer Service Department for details.

## SPECIAL PRODUCT ORDERS

We welcome the opportunity to quote special products. Any changes in look, build, finish or options must be processed through the Custom Product Order Program. Please contact our Customer Service Department for pricing and lead times.

**NOTE:** Due to the cost of creating custom products, a minimum charge per order may apply. Special product orders are non-returnable and non-refundable. *A 50% deposit is required* with the order for all special product orders.

## IN-TRANSIT DAMAGE

HPFI does not own or operate its own transportation equipment. All shipments made by HPFI are made using third party carriers or customer transportation HPFI manufactures and packages its products to withstand the normal handling incurred during transportation to provide for safe transit. HPFI ships only top quality undamaged merchandise. Title and ownership of merchandise is transferred to the dealer/customer when the freight carrier signs the bill of lading. The carrier assumes complete responsibility for delivering merchandise to the consignee in good condition.

**It is the responsibility of the dealer/customer to inspect all merchandise upon delivery to the customer-designated ship-to address. Any visible damage upon delivery must be noted on the bill of lading when the merchandise is signed for.** Freight carriers will accept responsibility for damage which upon their inspection they deem to be their fault. It is the buyers' responsibility to file freight claims with the responsible carrier.

HPFI will provide advice and assistance to its customers with the freight claim process and will use its influence to encourage carriers to accept their responsibility.

**Concealed Damage Claims must be filed within 15 days of delivery and original cartons must be retained.** Most carriers will not accept a claim for concealed damage if the claim is made more than 15 days after receipt, or if the merchandise is moved from the original delivery location. It is the buyers' responsibility to file claims for concealed damage with the freight carrier.

## RETURN AUTHORIZATION

An error made by HPFI resulting in shipment of an incorrect or defective product may be allowed for return to HPFI. **Such returns require prior authorization from the HPFI Customer Service Department.** Please call 800-447-3462 to request a Return Authorization and shipping instructions. **All returned products must be properly packaged to ensure safe transit.**

Certain products may not be returned under any circumstances:

- Any non-defective upholstered furniture.
- Any seating product made using customer owned material (COM or COL)
- Any seating or casegoods product made using special materials or custom finishes

- Any seating or casegoods product made to custom specifications of customer

**Returns for any other reason will only be allowed at the sole discretion of HPFI. All returns will be assessed a 30% restocking charge plus the cost of return freight.**

Return Authorizations (R.A.s) are valid for 45 days from the issue date. Authorized returns must have the R.A. number clearly marked on all cartons and the bill of lading. All cartons must arrive at the HPFI designated ship-to location within 45 days of the authorization. Failure to return merchandise within 45 days will result in the cancellation of the Return Authorization and demand for payment.

## RETURN GUIDELINES

- Merchandise must be returned in appropriate packaging to ensure safe transportation. Use the original packaging or the packaging from the replacement units including all inner and outer packaging to repack the returned product. If return is not HPFI's responsibility, repackaging and restocking charges will apply.
- All casegoods must be strapped Top-Side-Up to correct size pallet for return. DO NOT place upside down.
- All shipping documents and product cartons must be clearly marked with the HPFI's Return Authorization number.
- You must use the carrier noted on the Return Authorization.
- Failure to comply with requirements will void the Return Authorization; no money will be credited; full payment will be due HPFI.

All returned product shipments received by High Point will be promptly inspected to ensure:

- Authorized for return
- Accuracy of counts
- Validate reason for return

If approved, HPFI will issue credit to the customer less (where applicable) the 30% restocking charge, return freight and any costs incurred by HPFI to return the products to like new condition.

## CANCELLATIONS

Acknowledged orders are considered firm. No cancellations or changes will be allowed without the express written authorization of HPFI management. Changes may be subject to additional charges. Upholstered items may not be cancelled after the fabrics or other upholstery cover material has been cut. Quick Ship orders cannot be cancelled.

## REPAIR CHARGES

Authorization must be obtained from HPFI's Customer Service Department prior to incurring repair charges if HPFI is expected to pay all or part of these charges.

## CORRESPONDENCE

Direct all correspondence to:

**HPFI  
PO Box 2063  
High Point, NC 27261-2063**

Phone: **336-431-7101  
800-447-3462**

## CUSTOMER SERVICE/ORDER DESK

To order by fax:  
**800-231-6784**

Customer Service Fax:  
**336-434-5280**

E-mail: [orderentry@hpfi.com](mailto:orderentry@hpfi.com)

**Subject to the terms, conditions and exceptions stated below, High Point Furniture Industries, Inc. (“HPFI”), warrants that each finished product or separate component or part which it sells after April 1, 2001 (“Product”) will be free from defects in material and workmanship, when subject to normal commercial usage, for so long as the Product is owned by the original purchaser.** If the Product is sold by HPFI to a retailer or dealer, the “original purchaser” shall be the purchaser of the Product from the retailer or dealer. Otherwise, the “original purchaser” shall be the purchaser of the Product from HPFI. The original purchaser may not assign this warranty to any other person or entity.

## EXCEPTIONS:

**High-Wear Parts-** High-wear parts such as glides, gas cylinders, casters, ergonomic chair components, polymer-based components, and user-adjustable worksurface mechanisms are warranted against defects in material and workmanship only for a period of five years (three years on recliner mechanisms and casters) from the date on which the Product is sold by HPFI or until the product is no longer owned by the original purchaser, whichever is the shorter time period.

**Veneer Finishes-** Veneer finishes are warranted against defects in material and workmanship only for a period of three years from the date on which the Product is sold by HPFI or until the product is no longer owned by the original purchaser, whichever is the shorter time period.

**Electrical Components-** Electrical components are not warranted by HPFI, but may have warranties from the electrical component manufacturer.

**Fabrics-** Careful consideration is given to our selection of standard fabric offerings. The fabrics we have selected offer the best in appearance, durability and value; however, since we have no control over the environment, cleaning or other conditions which may affect colorfastness or durability, we cannot warrant fabrics beyond any warranty which may be provided to us by the fabric supplier. Customer’s own materials (COM) selected by and used at the request of a customer, are not warranted.

## CUSTOMER’S OWN MATERIAL

If HPFI agrees to use the Customer’s Own Material (COM) on HPFI brand products, or build a custom product:

–HPFI shall have no responsibility for the condition, quality, value, performance, physical properties, or any other aspect of the COM.

–HPFI shall have no liability for any damages, injuries, or losses to the customer or to any third party that shall be caused by any COM, and the customer shall hold HPFI harmless for all liability.

For complete COM order requirements and warranty information see the HPFI COM Order Form.

## EXCLUSIONS:

This warranty does not apply and no other warranty applies to:

- Normal wear and tear, which is to be expected over the course of ownership.
- Damage caused by the carrier in-transit, which will be handled under freight policy.
- Damage caused by or during installation.
- Modifications or attachments to the Product

that do not have the prior written approval of HPFI.

- Products that are not installed or used or maintained in accordance with Product instructions and warnings.
- Damage caused by neglect or misuse of a Product.
- Normal Commercial Usage- The Products are designed and manufactured for normal commercial usage. Normal commercial usage for seating is defined as the equivalent of a single shift, forty- (40) hour workweek. To the extent that a Product is used in a manner exceeding normal commercial usage, the warranty will be invalidated or HPFI may, at its option, elect to reduce the applicable warranty period on a pro-rated basis.
- Chairs used or designated 24/7 have a warranty of 5 years.
- Color Variations and Finishes- Some natural variations occurring in wood, leather or other natural materials are inherent to their character, and cannot be avoided. Therefore they are not considered defects in material or workmanship and are not the basis for a warranty claim. HPFI does not warrant the color-fastness or matching of colors or grains or textures of such materials.

EXCEPT AS SET FORTH ABOVE, HPFI MAKES NO EXPRESS WARRANTIES WITH RESPECT TO ITS PRODUCTS. HPFI MAKES NO IMPLIED REPRESENTATIONS OR WARRANTIES WITH RESPECT TO ITS PRODUCTS, THEIR CONDITION, MERCHANTABILITY, FITNESS FOR ANY PARTICULAR PURPOSE OR USE BY THE PURCHASER. HPFI FURNISHES THE ABOVE LIMITED EXPRESS WARRANTY IN LIEU OF ALL OTHER WARRANTIES, EXPRESSED OR IMPLIED, INCLUDING THE WARRANTIES OF MERCHANTABILITY AND FITNESS FOR A PARTICULAR PURPOSE. NO ORAL REPRESENTATIONS OR SAMPLES PROVIDED BY HPFI TO ANY RETAILER, DEALER OR PURCHASER WILL CREATE ANY EXPRESS OR IMPLIED WARRANTIES WITH RESPECT TO PRODUCTS SOLD BY HPFI.

**Remedies-** If any defect in the workmanship and material of any Product appears within the applicable warranty period, HPFI will, at its option, repair or replace the Product, at no charge, upon examination of the Product and verification by HPFI or its authorized representative of the defect and of compliance with the warranty requirements and conditions. The Purchaser must provide such cooperation and information as HPFI or the authorized representative may reasonably request to process the warranty claim.

IN THE EVENT OF ANY DEFECT IN ANY PRODUCT SOLD BY HPFI OR ANY BREACH OF THE LIMITED EXPRESS WARRANTY DESCRIBED ABOVE, THE SOLE REMEDY FOR SUCH DEFECT AND/OR BREACH SHALL BE AS STATED IN THIS PARAGRAPH, AND IN NO EVENT SHALL THE DEALER OR RETAILER THAT PURCHASED THE PRODUCT FROM HPFI OR THE ORIGINAL PURCHASER OF THE PRODUCT FROM THE DEALER OR RETAILER, BE ENTITLED TO RECOVER FROM HPFI ANY DAMAGES, INCLUDING DIRECT, CONSEQUENTIAL OR INCIDENTAL DAMAGES, LOST PROFITS, DOWNTIME OR OTHER DAMAGES OF ANY NATURE WHATSOEVER ARISING FROM BREACH OF WARRANTY OR THE CONDITION, FUNCTION OR USE OF THE PRODUCT.

## APPLICATION OF CURRENT WARRANTY AND PRIOR WARRANTIES

This express limited warranty applies only to Products sold by HPFI on or after April 1, 2001. HPFI has improved its warranty coverage and Products over the years. Products sold by HPFI before April 1, 2001 were covered by the warranty in effect at the time of manufacture and sale. Please see table below for general information pertaining to warranty coverage periods (measured from date of sale by HPFI) for Products sold before April 1, 2001. Further information concerning terms and conditions of prior warranties are available upon request to HPFI.

Casegoods & Seating manufactured and sold prior to July 1, 1994 -----  
2 years

Seating manufactured and sold after July 1, 1994 and prior to April 1, 2001 -----  
10 years

Casegoods manufactured and sold after July 1, 1994 and prior to August 1, 1997 -----  
5 years

Casegoods manufactured and sold after August 1, 1997 and prior to April 1, 2001 -----  
10 years

These warranties are made by HPFI only to authorized dealers and retailers acquiring Products directly from HPFI and the original purchaser of the Product as defined above.

The HPFI name and logo are registered trademarks of HPFI, Inc.



### GOT A TIGHT DEADLINE?

We will ship any of our casegoods marked as Quick Ship and any seating products covered with our extensive Quick Ship Fabric Program within three business days after the credit approved order is entered.

Casegood products selected for the Quick Ship Program are noted by the QS symbol. Quick Ship finish and pull options designated in note under model number.

Most seating items including chairs, sofas, loveseats and occasional tables are available for Quick Ship in the finishes listed and only with the Quick Ship fabrics noted on page 250. All other HPFI fabrics are available at standard lead times.

Any item ordered with installed options will not be available for Quick Ship.

### QUICK SHIP ORDERS

Your order must be clearly marked with Quick Ship and include only Quick Ship products. HPFI will make every effort to ship all credit approved Factory Quick Ship orders within three business days from the date the order is entered.

### QUANTITY ORDERS

The maximum order size for any SKU is 8 pieces per dealer, per day. There is no limit on total order size; however, there is a limit of 8 each of any Quick Ship item per day. - QS orders for the same item cannot be ordered consecutively in the same week without prior approval from HPFI. Should your need exceed the QS maximum for a QS item, please contact your Customer Service Representative for manufacturing time. (i.e. 12 items instead of 8 - HPFI may be able to offer you 12 items to ship in 6 days, etc.

However, HPFI reserves the right to limit quantities based on product availability.

### FAST CATS ERGONOMIC SEATING

Order up to 50 chairs from the Fast Cats ergonomic seating collections for shipment in just three business days! Please contact customer service for larger quantity orders and/or any special requests.

### CHANGES/CANCELLATIONS

#### CASEGOODS

To request a change or cancellation of a casegoods order, contact Customer Service to verify ability to adjust original order. If a change is made, the three business days begins anew from the date the change was made. No cancellations can be allowed once an order ships. HPFI is not responsible for any loss of sale or contract resulting from failure to ship within three business days.

#### SEATING

Due to the breadth of fabrics and finishes available, seating items cannot be changed or cancelled once the order has been entered.

### PAYMENT TERMS

Net thirty (30) days from date of invoice.

### DIRECT ALL CORRESPONDENCE TO

**HPFI, Inc.**  
**PO Box 2063**  
**High Point, NC 27261-2063**  
**USA**

Phone: **336-431-7101**  
Fax: **336-434-5280**

### CUSTOMER SERVICE ORDER DESK

Fax: **800-231-6784**  
Phone: **800-447-3462**  
E-mail: **orderentry@hpfi.com**  
Website: **www.hpfi.com**

### QUICK SHIP FABRICS

Fabrics listed on page 250.

# FINISHES

## CASEGOOD FINISHES BY SERIES

	Natural Maple	Medium Oak	Windsor Cherry	Honey Cherry	Mahogany	Grey	Graphite	Aspen	Pearwood	Black	Walnut	Espresso	Classic Cherry	Rouge Mahogany
Forté Veneer				•										
Affirm Veneer				•										•
Legacy Veneer														•
Westboro Veneer				•										•
Inverness Veneer				•										•
Stratus	•	•	•		•	•	•	•		•		•	•	
Vitality			•		•									
Elevation	•	•	•		•	•	•	•	•	•		•	•	
Elevation 2	•	**	•		•	**	**	•	**	**		**	**	
Atlas	•	**	•		•	**	**	•	**	**		**	**	
Hyperwork	•	•	•		•	•	•	•	•	•		•	•	
Uniwork	•	•	•		•	•	•	•	•	•		•	•	
Agility	•	•	•		•	•	•	•	•	•		•	•	
2200 Series		•	•		•						•			
Bravo Panel	•	•			•	•					•			
Bedford			•		•									
Wyndham		•	•		•									
Milan Tables	•	•	•		•	•	•	•				•	•	
Conference Tables	•	•	•	•	•	•	•	•	**	**		•	•	•
Occasional Tables	•	•	•	•	•	•	•	•	•	•	•	•	•	•
Training Tables	•	•	•		•	•	•	•				•	•	
Praxis	•	•	•		•	•		•	•	•		•	•	
Workcenter	•	**	•		•	**	**	•	**	**		**	**	

\*\* Base finish only

## FINISH COORDINATION

Casegoods	Seating
Natural Maple	<b>FM</b> Natural
Medium Oak	<b>OAK MOB</b> Medium Oak Moab
Aspen	<b>AP</b> Aspen
Pearwood	<b>PW</b> Pearwood
Windsor Cherry	<b>WC</b> Windsor Cherry
Honey Cherry	<b>HCY</b> Honey Cherry
Mahogany	<b>MAH</b> Mahogany
Rouge Mahogany	<b>RM</b> Rouge Mahogany
Black	<b>BLK</b> Black
Espresso	<b>ESP</b> Espresso
Classic Cherry	<b>CCY</b> Classic Cherry
Gunstock Walnut	<b>WAL</b> Walnut

The HPFI Finishes Card provides comprehensive visual reference to veneer, laminate and seating finishes for quick, easy selection. Ask your sales representative for your copy.

For Seating Finish Chart see page 251.

# veneer casegoods





## FINISH

Forté features **Honey Cherry** finish on book matched American Cherry veneer. All horizontal and vertical surfaces feature full-fill finish. Catalyzed lacquer topcoat creates a harder, more durable finish and includes high sheen. Desk pad or glass with stand-offs will further protect veneer tops.

## FINISH CHOICE

**C** Honey Cherry

## PULLS

Optional pulls are available in a beautiful contemporary design, solid metal with brushed chrome finish. To order place a **P** after the SKU# (Example: CVC720**P**). An up-charge of \$11 list per drawer will be added to the prices shown.

## CONSTRUCTION

All panels are 5-ply construction with commercial-grade coreboard center and two veneer sheets top and bottom. Veneer is cross-grained for strength.

**Pedestals, Credenzas, File Cabinets and Storage Units:** All pedestals are ¾" thick core surfaced with cherry veneer and edge banded as required. Panel ends are 1⅜" thick core surface with cherry veneer and edge banded as required. Adjustable leveling glides are pre-installed in a propeller nut. Units fully assembled with dowels/glue, wood cleats, metal brackets/screws and mechanical fasteners. Series features full modesty panels. Leveling glides preinstalled in a propeller nut.

## TOPS

All tops are 1⅜" thick, properly backed. All standard rectangular shaped tops have a solid hardwood edge with a stylish concave shape. All bridge and return tops feature common grain direction with desk/credenza as well as reverse coped edges for smooth work surface connection with desk/credenza. Bow, peninsula and round shape tops utilize a composite edge.

### IMPORTANT NOTE:

Because of the natural characteristics of wood, color may vary slightly between pieces. Color will mellow and age over time.

## DRAWERS

All drawer fronts are constructed of ¾" particleboard core with hardwood edge surfaced in cherry veneer. Drawer sides are ½" thick hardwood veneer interiors in a lacquer finish. Drawer bottoms are ⅜" thick plywood.

- All box drawers are suspended on smooth-action metal slides with steel ball bearings
- All file drawers and file cabinet drawers are mounted on heavy-duty steel ball bearing, full-extension slides
- Black ProFile filing hardware includes pre-installed rails with adjustable crossbars that lock into position
- All file drawers allow legal filing front-to-back and letter/legal filing side-to-side
- All lateral file drawers allow letter and/or legal filing front-to-back and legal filing side-to-side
- Maximum weight for bottom loading is 40 lb
- Drawers are constructed with 5 sides for extra strength and durability. The drawer front is the 5th side and is removable in the field for repairs or hardware additions

## WIRE MANAGEMENT

See features for number of grommets and location. Additional grommets can be added for extended wire management capability at \$106 list per grommet. Includes factory cut and installed grommet and black sleeve. Call for special quote. Specify location and quote number with order.

## LOCKS

- Individual front locking pedestals
- All locks are keyed identical unless otherwise specified
- 'Key Different' option is \$21 list upcharge per lock. Locks/cores packaged to customer requirements
- Additional lead time for 'Key Different'
- For optional locking on overhead storage units with four wood doors, add **Y** to the end of the model number and add \$150 to the list price of unit

## ACCESSORIES - Factory Installed

Certain accessories can be ordered installed prior to shipment. Add letter designator (C, K or T) at end of the desk, credenza or overhead model number:

- C** Center Drawer  
*Example: CVC660C*
- K** Keyboard Platform  
*Example: CVC704K*
- T** Task Light  
*Example: CVC727T*

## PACKAGING

All units are properly packed in heavy-duty cartons with reinforced corner pads. All packaging conforms to, or exceeds specifications as outlined in the Uniform Freight Classification.

All desks, credenzas, files and overhead storage units are shipped preassembled. Modular L-Shaped and U-Shaped workstations are shipped in multiple cartons, requiring connection in the field.

## QUICKSHIP

Quick Ship is not available on any items ordered with option.

## PALLETIZATION

See page 3.

## CARE & CLEANING INSTRUCTIONS FOR VENEER PRODUCTS

**Normal cleaning:** Wood veneer products require special care. When cleaning, it is important to use a quality window cleaner which contains no ammonia followed by a dry soft cloth to remove any dampness.

**Polish Suggestions:** To polish veneer furniture, we recommend that you use a quality furniture polish which contains no silicone followed by a dry soft cloth. Using a polish without silicone, will protect the everlasting beauty of this natural wood product.

**Warning –** Using a polish containing silicone may cloud the finish, soften, crack or lift the finish and void your warranty.

**Specifications subject to change without notice.**



**Configurations**

Zone Pricing

1

2

3

**Executive U Unit**

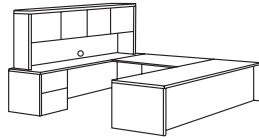

72" x 108" x 65"

Description	Model Number	Qty	Frnt.Class	Cubic Ft.	Ship Weight			
Right Full Pedestal Desk	CVC721R2BF 72" x 36" x 36.5"	1	110	51.6	248	<b>2923</b>	<b>2967</b>	<b>3011</b>
Desk Height Bridge	CVC485 48" x 24" x 29"	1	100	4.0	95	<b>866</b>	<b>879</b>	<b>892</b>
Left Full Pedestal Credenza	CVC725LF 72" x 24" x 29"	1	125	35.7	214	<b>2422</b>	<b>2458</b>	<b>2495</b>
Overhead Storage Unit	CVC727 72" x 16" x 36"	1	125	33.6	192	<b>2442</b>	<b>2479</b>	<b>2515</b>
Total:				124.90	749	<b>8653</b>	<b>8783</b>	<b>8913</b>

**Executive L Unit**

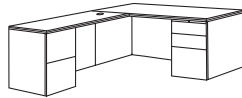

72" x 84" x 29"

Description	Model Number	Qty	Frnt.Class	Cubic Ft.	Ship Weight			
Right Full Pedestal Desk	CVC721R2BF 72" x 36" x 29"	1	110	51.6	248	<b>2923</b>	<b>2967</b>	<b>3011</b>
Left Full Pedestal Return	CVC722LF 48" x 24" x 29"	1	110	24.3	180	<b>1845</b>	<b>1873</b>	<b>1900</b>
Total:				75.90	428	<b>4768</b>	<b>4840</b>	<b>4911</b>

**Executive U-Shaped Workstation**



72" x 108" x 65"

Description	Model Number	Qty	Frnt.Class	Cubic Ft.	Ship Weight			
Peninsula Desk	CVC799 72" x 36" x 29"	1	125	16.0	146	<b>1368</b>	<b>1389</b>	<b>1409</b>
Desk Height Bridge	CVC485 48" x 24" x 29"	1	100	4.0	95	<b>866</b>	<b>879</b>	<b>892</b>
Left Full Pedestal Credenza	CVC725LF 72" x 24" x 29"	1	125	35.7	214	<b>2422</b>	<b>2458</b>	<b>2495</b>
Overhead Storage Unit	CVC727 72" x 16" x 36"	1	125	33.6	192	<b>2442</b>	<b>2479</b>	<b>2515</b>
Total:				89.30	647	<b>7098</b>	<b>7205</b>	<b>7311</b>

**Executive Corner Workstation**



90" x 90" x 29"

Description	Model Number	Qty	Frnt.Class	Cubic Ft.	Ship Weight			
Computer Corner	CVC449 42" x 42" x 29"	1	200	34.3	165	<b>1555</b>	<b>1578</b>	<b>1602</b>
Left 3/4 Pedestal Return	CVC722L 48" x 24" x 29"	1	110	24.3	173	<b>1564</b>	<b>1587</b>	<b>1611</b>
Right 3/4 Pedestal Return	CVC722R 48" x 24" x 29"	1	110	24.3	173	<b>1564</b>	<b>1587</b>	<b>1611</b>
Pullout Keyboard Platform	CVCK21 22" x 18" x 2.75"	1	92.5	2.0	13	<b>223</b>	<b>226</b>	<b>230</b>
Total:				84.90	524	<b>4906</b>	<b>4978</b>	<b>5054</b>

**Executive U-Shaped Workstation**



72" x 108" x 29"

Description	Model Number	Qty	Frnt.Class	Cubic Ft.	Ship Weight			
Peninsula Desk	CVC799 72" x 36" x 29"	1	125	16.0	146	<b>1368</b>	<b>1389</b>	<b>1409</b>
Desk Height Bridge	CVC485 48" x 24" x 29"	1	100	4.0	95	<b>866</b>	<b>879</b>	<b>892</b>
Left Full Pedestal Credenza	CVC725LF 72" x 24" x 29"	1	125	35.7	214	<b>2422</b>	<b>2458</b>	<b>2495</b>
Total:				55.70	455	<b>4656</b>	<b>4726</b>	<b>4796</b>

**L-Shaped Workstation**

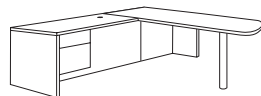

72" x 84" x 29"

Description	Model Number	Qty	Frnt.Class	Cubic Ft.	Ship Weight			
Peninsula Desk	CVC799 72" x 36" x 29"	1	125	16.0	146	<b>1368</b>	<b>1389</b>	<b>1409</b>
Left 3/4 Pedestal Return	CVC722L 48" x 24" x 29"	1	110	24.3	173	<b>1564</b>	<b>1587</b>	<b>1611</b>
Total:				40.30	319	<b>2932</b>	<b>2976</b>	<b>3020</b>



### Executive U-Shaped Workstation

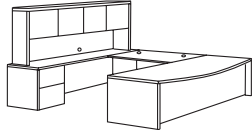

72" x 108" x 65"

Description	Model Number	Qty	Frt.Class	Cubic Ft.	Ship Weight	Zone Pricing		
						1	2	3
Right Full Pedestal Bow Front Desk	CVC721RB2BF <small>72" x 36" x 29"</small>	1	200	51.6	248	<b>3080</b>	<b>3126</b>	<b>3172</b>
Desk Height Bridge	CVC485 <small>48" x 24" x 29"</small>	1	100	4.0	95	<b>866</b>	<b>879</b>	<b>892</b>
Left Full Pedestal Credenza	CVC725LF <small>72" x 24" x 29"</small>	1	125	35.7	214	<b>2422</b>	<b>2458</b>	<b>2495</b>
Overhead Storage Unit	CVC727 <small>72" x 16" x 36"</small>	1	125	33.6	192	<b>2442</b>	<b>2479</b>	<b>2515</b>
<b>Total:</b>						<b>124.90</b>	<b>749</b>	<b>8810 8942 9074</b>

### Executive U-Shaped Workstation



72" x 108" x 29"

Description	Model Number	Qty	Frt.Class	Cubic Ft.	Ship Weight	Zone Pricing		
						1	2	3
Right Full Pedestal Desk	CVC721RF <small>72" x 36" x 29"</small>	1	110	51.6	264	<b>2923</b>	<b>2967</b>	<b>3011</b>
Desk Height Bridge	CVC485 <small>48" x 24" x 29"</small>	1	100	4.0	95	<b>866</b>	<b>879</b>	<b>892</b>
Left Full Pedestal Credenza	CVC725LF <small>72" x 24" x 29"</small>	1	125	35.7	214	<b>2422</b>	<b>2458</b>	<b>2495</b>
<b>Total:</b>						<b>91.30</b>	<b>573</b>	<b>6211 6304 6398</b>

### Reception Station

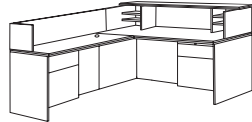

72" x 84" x 43"

Description	Model Number	Qty	Frt.Class	Cubic Ft.	Ship Weight	Zone Pricing		
						1	2	3
Right 3/4 Pedestal Desk	CVC721R <small>72" x 36" x 29"</small>	1	200	51.6	249	<b>2571</b>	<b>2610</b>	<b>2648</b>
Left 3/4 Pedestal Return	CVC722L <small>48" x 24" x 29"</small>	1	110	24.3	173	<b>1564</b>	<b>1587</b>	<b>1611</b>
Reception Screen For Desk	CVC709 <small>72" x 36" x 14"</small>	1	70	31.9	150	<b>2019</b>	<b>2049</b>	<b>2080</b>
Reception Screen for Left Return	CVC611L <small>48" x 24" x 13"</small>	1	70	1.5	27	<b>483</b>	<b>490</b>	<b>497</b>
<b>Total:</b>						<b>109.30</b>	<b>599</b>	<b>6637 6736 6836</b>

## DESKS Full Pedestal (Bow Front)

### Full Double Pedestal Bow Front Desk



Freight Class: 110

- Four file drawers, letter or legal filing
- Pre-installed PROFile filing hardware
- Front locking pedestals

<b>CVC720BF</b> 72" X 36" X 29" Cubic Ft: 51.6 Ship Weight: 323	<b>3735</b>	<b>3791</b>	<b>3847</b>
<b>Center Drawer C</b>	287	291	296
<b>Keyboard Platform K</b>	242	246	249

**Pulls:** Brushed Chrome **P \$44**

### Full Double Pedestal Bow Front Desk



Freight Class: 110

- Four box drawers
- Two file drawers, letter or legal filing
- Pre-installed PROFile filing hardware
- Front locking pedestals

<b>CVC720B2BF</b> 72" X 36" X 29" Cubic Ft: 51.6 Ship Weight: 321	<b>3735</b>	<b>3791</b>	<b>3847</b>
<b>Center Drawer C</b>	287	291	296
<b>Keyboard Platform K</b>	242	246	249

**Pulls:** Brushed Chrome **P \$66**

### Full Double Pedestal Bow Front Desk



Freight Class: 110

- Two box drawers
- Three file drawers, letter or legal filing
- Pre-installed PROFile filing hardware
- Front locking pedestals

<b>CVC720B2BFF</b> 72" X 36" X 29" Cubic Ft: 51.6 Ship Weight: 321	<b>3735</b>	<b>3791</b>	<b>3847</b>
<b>Center Drawer C</b>	287	291	296
<b>Keyboard Platform K</b>	242	246	249

**Pulls:** Brushed Chrome **P \$55**

UNIT	KNEESPACE	OVERHANG
72" Double Pedestal Desk	31-3/4"	10-1/2"
66" Double Pedestal Desk	25-3/4"	4-1/2"
72" Double Pedestal Credenza	31-3/4"	1"

**Full Double Pedestal Bow Front Desk**



- Two box drawers
- Three file drawers, letter or legal filing
- Pre-installed PROFile filing hardware
- Front locking pedestals

Freight Class: 110

		Zone Pricing	1	2	3
<b>CVC720BF2BF QS</b>	72" X 36" X 29" Cubic Ft: 51.6 Ship Weight: 321		<b>3735</b>	<b>3791</b>	<b>3847</b>
	<b>Center Drawer C</b>		287	291	296
	<b>Keyboard Platform K</b>		242	246	249
<b>Pulls:</b>		Brushed Chrome	<b>P \$55</b>		

**Left Full Pedestal Bow Front Desk**

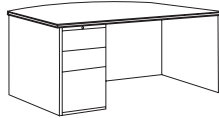

- Two box drawers
- One file drawer, letter or legal filing
- Pre-installed PROFile filing hardware
- Front locking pedestals
- Connects with return or bridge/credenza

Freight Class: 200

<b>CVC721LB2BF</b>	72" X 36" X 29" Cubic Ft: 51.6 Ship Weight: 248		<b>3080</b>	<b>3126</b>	<b>3172</b>
	<b>Center Drawer C</b>		287	291	296
	<b>Keyboard Platform K</b>		223	226	230
<b>Pulls:</b>		Brushed Chrome	<b>P \$33</b>		

**Left Full Pedestal Bow Front Desk**

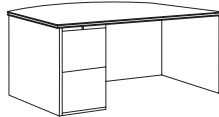

- Two file drawers, letter or legal filing
- Pre-installed PROFile filing hardware
- Front locking pedestals
- Connects with return or bridge/credenza

Freight Class: 200

<b>CVC721LBF</b>	72" X 36" X 29" Cubic Ft: 51.6 Ship Weight: 249		<b>3080</b>	<b>3126</b>	<b>3172</b>
	<b>Center Drawer C</b>		287	291	296
	<b>Keyboard Platform K</b>		223	226	230
<b>Pulls:</b>		Brushed Chrome	<b>P \$22</b>		

**Right Full Pedestal Bow Front Desk**

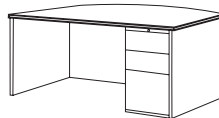

- Two box drawers
- One file drawer, letter or legal filing
- Pre-installed PROFile filing hardware
- Front locking pedestals
- Connects with return or bridge/credenza

Freight Class: 200

<b>CVC721RB2BF</b>	72" X 36" X 29" Cubic Ft: 51.6 Ship Weight: 248		<b>3080</b>	<b>3126</b>	<b>3172</b>
	<b>Center Drawer C</b>		287	291	296
	<b>Keyboard Platform K</b>		223	226	230
<b>Pulls:</b>		Brushed Chrome	<b>P \$33</b>		

**Right Full Pedestal Bow Front Desk**

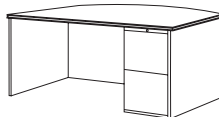

- Two file drawers, letter or legal filing
- Pre-installed PROFile filing hardware
- Front locking pedestals
- Connects with return or bridge/credenza

Freight Class: 200

<b>CVC721RBF</b>	72" X 36" X 29" Cubic Ft: 51.6 Ship Weight: 249		<b>3080</b>	<b>3126</b>	<b>3172</b>
	<b>Center Drawer C</b>		287	291	296
	<b>Keyboard Platform K</b>		223	226	230
<b>Pulls:</b>		Brushed Chrome	<b>P \$22</b>		

**DESKS Full Pedestal (Rectangular)**

**Full Double Pedestal Desk**

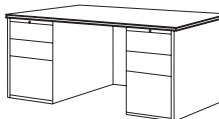

- Four box drawers
- Two file drawers, letter or filing
- Pre-installed PROFile filing hardware
- Front locking pedestals

Freight Class: 110

<b>CVC7202BF</b>	72" X 36" X 29" Cubic Ft: 51.6 Ship Weight: 323		<b>3578</b>	<b>3632</b>	<b>3685</b>
	<b>Center Drawer C</b>		287	291	296
	<b>Keyboard Platform K</b>		242	246	249
<b>CVC6602BF</b>	66" X 30" X 29" Cubic Ft: 40.2 Ship Weight: 314		<b>3414</b>	<b>3465</b>	<b>3516</b>
	<b>Center Drawer C</b>		274	278	282
	<b>Keyboard Platform K</b>		242	246	249
<b>Pulls:</b>		Brushed Chrome	<b>P \$66</b>		



Zone Pricing	1	2	3
--------------	---	---	---

### Full Double Pedestal Desk

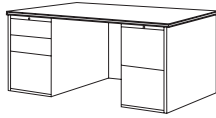

- Two box drawers
- Three file drawers, letter or filing
- Pre-installed PROFile filing hardware
- Front locking pedestals

Freight Class: 110

<b>CVC7202BFF QS</b> 72" X 36" X 29" Cubic Ft: 51.6 Ship Weight: 336	<b>3578</b>	<b>3632</b>	<b>3685</b>
<b>Center Drawer C</b>	287	291	296
<b>Keyboard Platform K</b>	242	246	249
<b>CVC6602BFF</b> 66" X 30" X 29" Cubic Ft: 40.2 Ship Weight: 315	<b>3414</b>	<b>3465</b>	<b>3516</b>
<b>Center Drawer C</b>	274	278	282
<b>Keyboard Platform K</b>	242	246	249

**Pulls:** Brushed Chrome **P \$55**

### Full Double Pedestal Desk



- Two box drawers
- Three file drawers, letter or legal filing
- Pre-installed PROFile filing hardware
- Front locking pedestals

Freight Class: 110

<b>CVC720F2BF QS</b> 72" X 36" X 29" Cubic Ft: 51.6 Ship Weight: 336	<b>3578</b>	<b>3632</b>	<b>3685</b>
<b>Center Drawer C</b>	287	291	296
<b>Keyboard Platform K</b>	242	246	249
<b>CVC660F2BF</b> 66" X 30" X 29" Cubic Ft: 40.2 Ship Weight: 315	<b>3414</b>	<b>3465</b>	<b>3516</b>
<b>Center Drawer C</b>	274	278	282
<b>Keyboard Platform K</b>	242	246	249

**Pulls:** Brushed Chrome **P \$55**

### Full Double Pedestal Desk



- Four file drawers, letter or legal filing
- Pre-installed PROFile filing hardware
- Front locking pedestals

Freight Class: 110

<b>CVC720F QS</b> 72" X 36" X 29" Cubic Ft: 51.6 Ship Weight: 338	<b>3578</b>	<b>3632</b>	<b>3685</b>
<b>Center Drawer C</b>	287	291	296
<b>Keyboard Platform K</b>	242	246	249
<b>CVC660F</b> 66" X 30" X 29" Cubic Ft: 40.2 Ship Weight: 316	<b>3414</b>	<b>3465</b>	<b>3516</b>
<b>Center Drawer C</b>	274	278	282
<b>Keyboard Platform K</b>	242	246	249

**Pulls:** Brushed Chrome **P \$44**

### Left Full Pedestal Desk



- Two box drawers
- One file drawer, letter or legal filing
- Pre-installed PROFile filing hardware
- Front locking pedestal
- Connects with return or bridge/credenza

Freight Class: 110

<b>CVC721L2BF</b> 72" X 36" X 29" Cubic Ft: 51.6 Ship Weight: 264	<b>2923</b>	<b>2967</b>	<b>3011</b>
<b>Center Drawer C</b>	287	291	296
<b>Keyboard Platform K</b>	223	226	230
<b>CVC651L2BF</b> 66" X 30" X 29" Cubic Ft: 40.2 Ship Weight: 241	<b>2759</b>	<b>2800</b>	<b>2842</b>
<b>Center Drawer C</b>	274	278	282
<b>Keyboard Platform K</b>	223	226	230

**Pulls:** Brushed Chrome **P \$33**

### Left Full Pedestal Desk



- Two file drawers, letter or legal filing
- Pre-installed PROFile filing hardware
- Front locking pedestal
- Connects with return or bridge/credenza

Freight Class: 110

<b>CVC721LF</b> 72" X 36" X 29" Cubic Ft: 51.6 Ship Weight: 264	<b>2923</b>	<b>2967</b>	<b>3011</b>
<b>Center Drawer C</b>	287	291	296
<b>Keyboard Platform K</b>	223	226	230
<b>CVC651LF</b> 66" X 30" X 29" Cubic Ft: 40.2 Ship Weight: 242	<b>2759</b>	<b>2800</b>	<b>2842</b>
<b>Center Drawer C</b>	274	278	282
<b>Keyboard Platform K</b>	223	226	230

**Pulls:** Brushed Chrome **P \$22**

### Right Full Pedestal Desk



- Two box drawers
- One file drawer, letter or legal filing
- Pre-installed PROFile filing hardware
- Front locking pedestal
- Connects with return or bridge/credenza

Freight Class: 110

<b>CVC721R2BF</b> 72" X 36" X 29" Cubic Ft: 51.6 Ship Weight: 264	<b>2923</b>	<b>2967</b>	<b>3011</b>
<b>Center Drawer C</b>	287	291	296
<b>Keyboard Platform K</b>	223	226	230
<b>CVC651R2BF</b> 66" X 30" X 29" Cubic Ft: 40.2 Ship Weight: 241	<b>2759</b>	<b>2800</b>	<b>2842</b>
<b>Center Drawer C</b>	274	278	282
<b>Keyboard Platform K</b>	223	226	230

**Pulls:** Brushed Chrome **P \$33**



**Right Full Pedestal Desk**



- Two file drawers, letter or legal filing
- Pre-installed PROFile filing hardware
- Front locking pedestal
- Connects with return or bridge/credenza

Freight Class: 110

		Zone Pricing		
		1	2	3
<b>CVC721RF</b>	72" X 36" X 29" Cubic Ft: 51.6 Ship Weight: 264	<b>2923</b>	<b>2967</b>	<b>3011</b>
	<b>Center Drawer C</b>	287	291	296
	<b>Keyboard Platform K</b>	223	226	230
<b>CVC651RF</b>	66" X 30" X 29" Cubic Ft: 40.2 Ship Weight: 242	<b>2759</b>	<b>2800</b>	<b>2842</b>
	<b>Center Drawer C</b>	274	278	282
	<b>Keyboard Platform K</b>	223	226	230

**Pulls:** Brushed Chrome **P \$22**

**DESKS 3/4 Pedestal (Bow Front)**

**Double 3/4 Pedestal Bow Front Desk**



- Two box drawers
- Two file drawers, letter or legal filing
- Pre-installed PROFile filing hardware
- Front locking pedestals
- Connects with return or bridge/credenza

Freight Class: 110

<b>CVC720B</b>	<b>QS</b> 72" X 36" X 29" Cubic Ft: 51.6 Ship Weight: 291	<b>3001</b>	<b>3046</b>	<b>3091</b>
	<b>Center Drawer C</b>	287	291	296
	<b>Keyboard Platform K</b>	242	246	249

**Pulls:** Brushed Chrome **P \$44**

**Left 3/4 Pedestal Bow Front Desk**



- One box drawer
- One file drawer, letter or legal filing
- Pre-installed PROFile filing hardware
- Front locking pedestal
- Connects with return or bridge/credenza

Freight Class: 200

<b>CVC721LB</b>	<b>QS</b> 72" X 36" X 29" Cubic Ft: 51.6 Ship Weight: 233	<b>2716</b>	<b>2757</b>	<b>2797</b>
	<b>Center Drawer C</b>	287	291	296
	<b>Keyboard Platform K</b>	223	226	230

**Pulls:** Brushed Chrome **P \$22**

**Right 3/4 Pedestal Bow Front Desk**

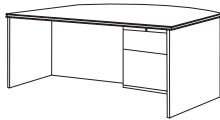

- One box drawer
- One file drawer, letter or legal filing
- Pre-installed PROFile filing hardware
- Front locking pedestal
- Connects with return or bridge/credenza

Freight Class: 200

<b>CVC721RB</b>	<b>QS</b> 72" X 36" X 29" Cubic Ft: 51.6 Ship Weight: 233	<b>2716</b>	<b>2757</b>	<b>2797</b>
	<b>Center Drawer C</b>	287	291	296
	<b>Keyboard Platform K</b>	223	226	230

**Pulls:** Brushed Chrome **P \$22**

**DESKS 3/4 Pedestal (Rectangular)**

**Double 3/4 Pedestal Pedestal Desk**

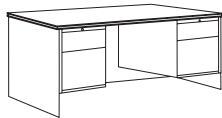

- Two box drawers
- Two file drawers, letter or legal filing
- Pre-installed PROFile filing hardware
- Front locking pedestals

Freight Class: 110

<b>CVC720</b>	<b>QS</b> 72" X 36" X 29" Cubic Ft: 51.6 Ship Weight: 306	<b>2858</b>	<b>2901</b>	<b>2944</b>
	<b>Center Drawer C</b>	287	291	296
	<b>Keyboard Platform K</b>	242	246	249

<b>CVC660</b>	<b>QS</b> 66" X 30" X 29" Cubic Ft: 40.2 Ship Weight: 284	<b>2681</b>	<b>2721</b>	<b>2761</b>
	<b>Center Drawer C</b>	274	278	282
	<b>Keyboard Platform K</b>	242	246	249

**Pulls:** Brushed Chrome **P \$44**

**Left 3/4 Pedestal Pedestal Desk**



- One box drawer
- One file drawer, letter or legal filing
- Pre-installed PROFile filing hardware
- Front locking pedestal
- Connects with return or bridge/credenza

<b>CVC721L</b>	<b>QS</b> 72" X 36" X 29" Cubic Ft: 51.6 Ship Weight: 249	<b>2571</b>	<b>2610</b>	<b>2648</b>
Freight Class: 200	<b>Center Drawer C</b>	287	291	296
	<b>Keyboard Platform K</b>	223	226	230

<b>CVC651L</b>	<b>QS</b> 66" X 30" X 29" Cubic Ft: 40.2 Ship Weight: 226	<b>2394</b>	<b>2430</b>	<b>2466</b>
Freight Class: 110	<b>Center Drawer C</b>	274	278	282
	<b>Keyboard Platform K</b>	223	226	230

**Pulls:** Brushed Chrome **P \$22**



### Right 3/4 Pedestal Pedestal Desk



- One box drawer
- One file drawer, letter or legal filing
- Pre-installed PROFile filing hardware
- Front locking pedestals
- Connects with return or bridge/credenza

		Zone Pricing	1	2	3
<b>CVC721R QS</b>	72" X 36" X 29" Cubic Ft: 51.6 Ship Weight: 249		<b>2571</b>	<b>2610</b>	<b>2648</b>
Freight Class: 200		<b>Center Drawer C</b>	287	291	296
		<b>Keyboard Platform K</b>	223	226	230
<b>CVC651R QS</b>	66" X 30" X 29" Cubic Ft: 40.2 Ship Weight: 226		<b>2394</b>	<b>2430</b>	<b>2466</b>
Freight Class: 110		<b>Center Drawer C</b>	274	278	282
		<b>Keyboard Platform K</b>	223	226	230
		<b>Pulls:</b>	Brushed Chrome <b>P \$22</b>		

## DESKS (Table, Peninsula & Computer)

### Table Desk, Tapered Leg

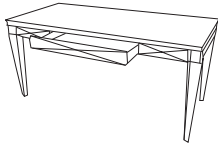

- Rectangular top and tapered legs
- Keyboard drawer with drop-down front
- Assembly required

Freight Class: 125

<b>CVC602</b>	66" X 30" X 30.75" Cubic Ft: 15 Ship Weight: 132	<b>1542</b>	<b>1565</b>	<b>1588</b>
---------------	--	-------------	-------------	-------------

### Peninsula Desk

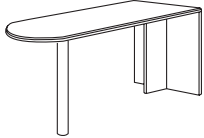

- End support panel
- Steel support cylinder in black finish, 4" in diameter
- Leveling glide in cylinder
- Connects with return or bridge/credenza
- Assembly required

Freight Class: 125

<b>CVC799</b>	72" X 36" X 29" Cubic Ft: 16 Ship Weight: 146	<b>1368</b>	<b>1389</b>	<b>1409</b>
---------------	---	-------------	-------------	-------------

### Computer Corner Unit



- One wire management grommet in top
- Use with returns or bridges/credenzas

Freight Class: 200

<b>CVC449</b>	42" X 42" X 29" Cubic Ft: 34.3 Ship Weight: 165	<b>1555</b>	<b>1578</b>	<b>1602</b>
		<b>Keyboard Platform K</b>	223	226

## CREDENZAS Full Pedestal (Double Pedestal)

### Full Double Pedestal Credenza

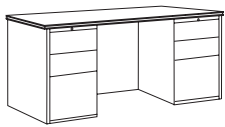

- Four box drawers
- Two file drawers, letter or legal filing
- Pre-installed PROFile filing hardware
- Front locking pedestals
- One grommet in modesty panel

Freight Class: 110

<b>CVC7042BF QS</b>	72" X 24" X 29" Cubic Ft: 37.5 Ship Weight: 279	<b>3068</b>	<b>3114</b>	<b>3160</b>
		<b>Center Drawer C</b>	287	291
		<b>Keyboard Platform K</b>	242	246
		<b>Pulls:</b>	Brushed Chrome <b>P \$66</b>	

### Full Double Pedestal Credenza

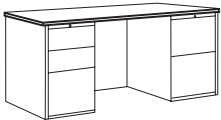

- Two box drawers
- Three file drawers, letter or legal filing
- Pre-installed PROFile filing hardware
- Front locking pedestals
- One grommet in modesty panel

Freight Class: 110

<b>CVC7042BFF</b>	72" X 24" X 29" Cubic Ft: 35.7 Ship Weight: 278	<b>3068</b>	<b>3114</b>	<b>3160</b>
		<b>Center Drawer C</b>	287	291
		<b>Keyboard Platform K</b>	242	246
		<b>Pulls:</b>	Brushed Chrome <b>P \$55</b>	

Zone Pricing	1	2	3
--------------	---	---	---

**Full Double Pedestal Credenza**

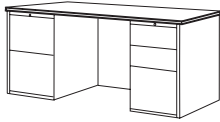

- Two box drawers
- Three file drawers, letter or legal filing
- Pre-installed PROFile filing hardware
- Front locking pedestals
- One grommet in modesty panel

Freight Class: 110

<b>CVC704F2BF QS</b>	72" X 24" X 29" Cubic Ft: 35.7 Ship Weight: 278	<b>3068</b>	<b>3114</b>	<b>3160</b>
	<b>Center Drawer C</b>	287	291	296
	<b>Keyboard Platform K</b>	242	246	249

**Pulls:** Brushed Chrome **P \$55**

**Full Double Pedestal Credenza**

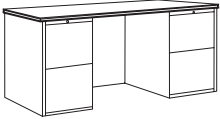

- Four file drawers, letter or legal filing
- Pre-installed PROFile filing hardware
- Front locking pedestal
- One grommet in modesty panel

Freight Class: 110

<b>CVC704F</b>	72" X 24" X 29" Cubic Ft: 35.7 Ship Weight: 277	<b>3068</b>	<b>3114</b>	<b>3160</b>
	<b>Center Drawer C</b>	287	291	296
	<b>Keyboard Platform K</b>	242	246	249

**Pulls:** Brushed Chrome **P \$44**

**CREDENZAS Full Pedestal (Single Pedestal)**

**Left Lateral File Credenza**

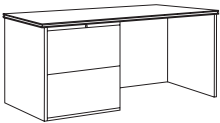

- Two lateral file drawers
- Pre-installed PROFile filing hardware
- Front locking pedestal
- Connects with bridge/desk or return

Freight Class: 125

<b>CVC733L</b>	72" X 24" X 29" Cubic Ft: 35.7 Ship Weight: 234	<b>2499</b>	<b>2536</b>	<b>2574</b>
----------------	---	-------------	-------------	-------------

**Pulls:** Brushed Chrome **P \$22**

**Right Lateral File Credenza**

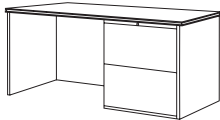

- Two lateral file drawers, letter or legal filing
- Pre-installed PROFile filing hardware
- Front locking pedestal
- Connects with bridge/desk or return

Freight Class: 125

<b>CVC733R</b>	72" X 24" X 29" Cubic Ft: 35.7 Ship Weight: 234	<b>2499</b>	<b>2536</b>	<b>2574</b>
----------------	---	-------------	-------------	-------------

**Pulls:** Brushed Chrome **P \$22**

**Left Full Pedestal Credenza**

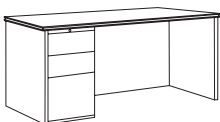

- Two box drawers
- One file drawer, letter or legal filing
- Pre-installed PROFile filing hardware
- Front locking pedestal
- Connects with bridge/desk or return
- One grommet in modesty panel

Freight Class: 125

<b>CVC725L2BF</b>	72" X 24" X 29" Cubic Ft: 35.7 Ship Weight: 215	<b>2422</b>	<b>2458</b>	<b>2495</b>
	<b>Center Drawer C</b>	287	291	296
	<b>Keyboard Platform K</b>	223	226	230

**Pulls:** Brushed Chrome **P \$33**

**Left Full Pedestal Credenza**

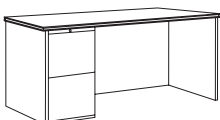

- Two file drawers, letter or legal filing
- Pre-installed PROFile filing hardware
- Front locking pedestal
- Connects with bridge/desk or return
- One grommet in modesty panel

Freight Class: 125

<b>CVC725LF</b>	72" X 24" X 29" Cubic Ft: 35.7 Ship Weight: 214	<b>2422</b>	<b>2458</b>	<b>2495</b>
	<b>Center Drawer C</b>	287	291	296
	<b>Keyboard Platform K</b>	223	226	230

**Pulls:** Brushed Chrome **P \$22**



### Right Full Pedestal Credenza

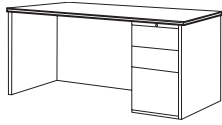

- Two box drawers,
- One file drawer, letter or legal filing
- Pre-installed PROFile filing hardware
- Front locking pedestals
- Connects with bridge/desk or return
- One grommet in modesty panel

Freight Class: 125

Zone Pricing	1	2	3
	<b>CVC725R2BF</b> 72" X 24" X 29" Cubic Ft: 35.7 Ship Weight: 215	<b>2422</b>	<b>2458</b>
<b>Center Drawer C</b>	287	291	296
<b>Keyboard Platform K</b>	223	226	230

**Pulls:** Brushed Chrome **P \$33**

### Right Full Pedestal Credenza

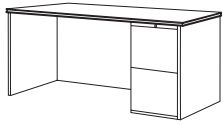

- Two file drawers, letter or legal filing
- Pre-installed PROFile filing hardware
- Front locking pedestals
- Connects with bridge/desk or return
- One grommet in modesty panel

Freight Class: 125

<b>CVC725RF</b> 72" X 24" X 29" Cubic Ft: 35.7 Ship Weight: 214	<b>2422</b>	<b>2458</b>	<b>2495</b>
<b>Center Drawer C</b>	287	291	296
<b>Keyboard Platform K</b>	223	226	230

**Pulls:** Brushed Chrome **P \$22**

## CREDENZAS 3/4 Pedestal

### 3/4 Pedestal Storage Credenza

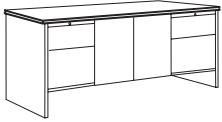

- Two box drawers
- Two file drawers, letter or legal filing
- Pre-installed PROFile filing hardware
- Front locking pedestals
- Storage compartment in center with two hinged doors and one adjustable shelf

Freight Class: 125

<b>CVC714</b> 72" X 24" X 29" Cubic Ft: 35.7 Ship Weight: 296	<b>2850</b>	<b>2893</b>	<b>2936</b>
---	-------------	-------------	-------------

**Pulls:** Brushed Chrome **P \$66**

### 3/4 Pedestal Computer Credenza

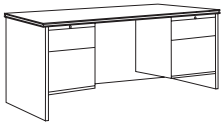

- Two box drawers
- Two file drawers, letter or legal filing
- Pre-installed PROFile filing hardware
- Front locking pedestals

Freight Class: 110

<b>CVC704 QS</b> 72" X 24" X 29" Cubic Ft: 35.7 Ship Weight: 263	<b>2505</b>	<b>2543</b>	<b>2580</b>
<b>Center Drawer C</b>	287	291	296
<b>Keyboard Platform K</b>	242	246	249

**Pulls:** Brushed Chrome **P \$44**

### Left 3/4 Pedestal Credenza

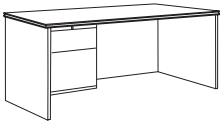

- One box drawer
- One file drawer, letter or legal filing
- Pre-installed PROFile filing hardware
- Front locking pedestals
- Connects with return or bridge/desk

Freight Class: 125

<b>CVC725L QS</b> 72" X 24" X 29" Cubic Ft: 35.7 Ship Weight: 207	<b>2142</b>	<b>2174</b>	<b>2206</b>
<b>Center Drawer C</b>	287	291	296
<b>Keyboard Platform K</b>	223	226	230

**Pulls:** Brushed Chrome **P \$22**

### Right 3/4 Pedestal Credenza

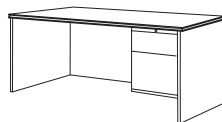

- One box drawer
- One file drawer, letter or legal filing
- Pre-installed PROFile filing hardware
- Front locking pedestals
- Connects with return or bridge/desk

Freight Class: 125

<b>CVC725R QS</b> 72" X 24" X 29" Cubic Ft: 35.7 Ship Weight: 207	<b>2142</b>	<b>2174</b>	<b>2206</b>
<b>Center Drawer C</b>	287	291	296
<b>Keyboard Platform K</b>	223	226	230

**Pulls:** Brushed Chrome **P \$22**



Returns & Bridges

Zone Pricing	1	2	3
--------------	---	---	---

Left Full Pedestal Return

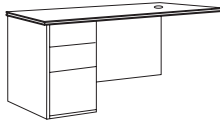

Freight Class: 110

- Two box drawers
- One file drawer, letter or legal filing
- Pre-installed PROFile filing hardware
- Front locking pedestals
- One grommet in top
- Reverse coped edge
- Common grain direction

<b>CVC722L2BF QS</b>	48" X 24" X 29"	Cubic Ft: 24.3	Ship Weight: 181	<b>1845</b>	<b>1873</b>	<b>1900</b>
				<b>Keyboard Platform K</b>	223	226 230
<b>CVC622L2BF QS</b>	42" X 24" X 29"	Cubic Ft: 21.8	Ship Weight: 171	<b>1683</b>	<b>1708</b>	<b>1733</b>
				<b>Keyboard Platform K</b>	223	226 230
<b>Pulls:</b>				Brushed Chrome	<b>P \$33</b>	

Left Full Pedestal Return

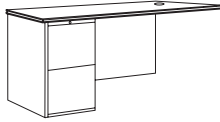

Freight Class: 110

- Two file drawers, letter or legal filing
- Pre-installed PROFile filing hardware
- Front locking pedestals
- One grommet in top
- Reverse coped edge
- Common grain direction

<b>CVC722LF</b>	48" X 24" X 29"	Cubic Ft: 24.3	Ship Weight: 180	<b>1845</b>	<b>1873</b>	<b>1900</b>
				<b>Keyboard Platform K</b>	223	226 230
<b>CVC622LF</b>	42" X 24" X 29"	Cubic Ft: 21.8	Ship Weight: 170	<b>1683</b>	<b>1708</b>	<b>1733</b>
				<b>Keyboard Platform K</b>	223	226 230
<b>Pulls:</b>				Brushed Chrome	<b>P \$22</b>	

Right Full Pedestal Return

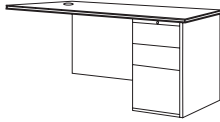

Freight Class: 110

- Two box drawers
- One file drawer, letter or legal filing
- Pre-installed PROFile filing hardware
- Front locking pedestals
- One grommet in top
- Reverse coped edge
- Common grain direction

<b>CVC722R2BF</b>	48" X 24" X 29"	Cubic Ft: 24.3	Ship Weight: 181	<b>1845</b>	<b>1873</b>	<b>1900</b>
				<b>Keyboard Platform K</b>	223	226 230
<b>CVC622R2BF</b>	42" X 24" X 29"	Cubic Ft: 21.8	Ship Weight: 171	<b>1683</b>	<b>1708</b>	<b>1733</b>
				<b>Keyboard Platform K</b>	223	226 230
<b>Pulls:</b>				Brushed Chrome	<b>P \$33</b>	

Right Full Pedestal Return

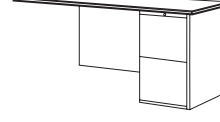

Freight Class: 110

- Two file drawers, letter or legal filing
- Pre-installed PROFile filing hardware
- Front locking pedestals
- One grommet in top
- Reverse coped edge
- Common grain direction

<b>CVC722RF</b>	48" X 24" X 29"	Cubic Ft: 24.3	Ship Weight: 180	<b>1845</b>	<b>1873</b>	<b>1900</b>
				<b>Keyboard Platform K</b>	223	226 230
<b>CVC622RF</b>	42" X 24" X 29"	Cubic Ft: 21.8	Ship Weight: 170	<b>1683</b>	<b>1708</b>	<b>1733</b>
				<b>Keyboard Platform K</b>	223	226 230
<b>Pulls:</b>				Brushed Chrome	<b>P \$22</b>	

Left 3/4 Pedestal Return

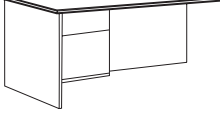

Freight Class: 110

- One box drawer
- One file drawer, letter or legal filing
- Pre-installed PROFile filing hardware
- Front locking pedestals
- One grommet in top
- Reverse coped edge
- Common grain direction with desk

<b>CVC722L QS</b>	48" X 24" X 29"	Cubic Ft: 24.3	Ship Weight: 173	<b>1564</b>	<b>1587</b>	<b>1611</b>
				<b>Keyboard Platform K</b>	223	226 230
<b>CVC622L</b>	42" X 24" X 29"	Cubic Ft: 21.8	Ship Weight: 163	<b>1402</b>	<b>1423</b>	<b>1444</b>
				<b>Keyboard Platform K</b>	223	226 230
<b>Pulls:</b>				Brushed Chrome	<b>P \$22</b>	

Right 3/4 Pedestal Return

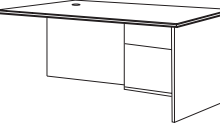

Freight Class: 110

- One box drawer
- One file drawer, letter or legal filing
- Pre-installed PROFile filing hardware
- Front locking pedestals
- One grommet in top
- Reverse coped edge
- Common grain direction with desk

<b>CVC722R QS</b>	48" X 24" X 29"	Cubic Ft: 24.3	Ship Weight: 173	<b>1564</b>	<b>1587</b>	<b>1611</b>
				<b>Keyboard Platform K</b>	223	226 230
<b>CVC622R</b>	42" X 24" X 29"	Cubic Ft: 21.8	Ship Weight: 163	<b>1402</b>	<b>1423</b>	<b>1444</b>
				<b>Keyboard Platform K</b>	223	226 230
<b>Pulls:</b>				Brushed Chrome	<b>P \$22</b>	

Bridge

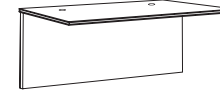

Freight Class: 100

- Two wire management grommets
- Reverse coped edge
- Common grain direction with desk and credenza

<b>CVC485 QS</b>	48" X 24" X 29"	Cubic Ft: 4	Ship Weight: 95	<b>866</b>	<b>879</b>	<b>892</b>
<b>CVC484 QS</b>	42" X 24" X 29"	Cubic Ft: 4	Ship Weight: 80	<b>742</b>	<b>753</b>	<b>764</b>



## Shells

Zone Pricing

1

2

3

### Bow Front Desk Shell



- Open desk shell for maximum flexibility in configuration
- Use with return or bridge/credenza

Freight Class: 200

<b>CVC710B</b>	<b>QS</b>	72" X 36" X 29"	Cubic Ft: 51.6	Ship Weight: 175	<b>2427</b>	<b>2463</b>	<b>2500</b>
----------------	-----------	-----------------	----------------	------------------	-------------	-------------	-------------

### Desk Shell



- Open desk shell for maximum flexibility in configuration
- Use with return or bridge/credenza

Freight Class: 200

<b>CVC710</b>	<b>QS</b>	72" X 36" X 29"	Cubic Ft: 51.6	Ship Weight: 190	<b>2284</b>	<b>2318</b>	<b>2353</b>
---------------	-----------	-----------------	----------------	------------------	-------------	-------------	-------------

<b>CVC650</b>	<b>QS</b>	66" X 30" X 29"	Cubic Ft: 40.2	Ship Weight: 168	<b>2106</b>	<b>2138</b>	<b>2169</b>
---------------	-----------	-----------------	----------------	------------------	-------------	-------------	-------------

### Credenza Shell

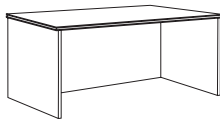

- Open credenza shell for maximum flexibility in configuration
- Use with return or bridge/credenza

Freight Class: 125

<b>CVC724</b>	<b>QS</b>	72" X 24" X 29"	Cubic Ft: 35.7	Ship Weight: 151	<b>1780</b>	<b>1807</b>	<b>1833</b>
---------------	-----------	-----------------	----------------	------------------	-------------	-------------	-------------

## Files, Bookcases & Overhead Storage

### Overhead Storage

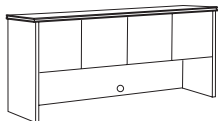

- Two storage compartments behind four doors
- 19" clearance under doors
- Grommet in back panel

Freight Class: 125

<b>CVC727</b>	<b>QS</b>	72" X 16" X 36"	Cubic Ft: 33.6	Ship Weight: 192	<b>2442</b>	<b>2479</b>	<b>2515</b>
---------------	-----------	-----------------	----------------	------------------	-------------	-------------	-------------

<b>Task Light T</b>	124	126	128
---------------------	-----	-----	-----

<b>LED Task Light L</b>	212	215	218
-------------------------	-----	-----	-----

<b>Pulls:</b>	Brushed Chrome	<b>P \$44</b>	<b>Locks:</b>	\$150.00:	<b>Y</b>
---------------	----------------	---------------	---------------	-----------	----------

### Lateral File



- Two lateral file drawers, letter or legal filing
- Pre-installed ProFile filing hardware
- Front central locking
- Anti-tilt allows for only one drawer to open at a time

Freight Class: 100

<b>CVC346</b>	<b>QS</b>	37" X 24" X 29"	Cubic Ft: 19.5	Ship Weight: 184	<b>2028</b>	<b>2058</b>	<b>2089</b>
---------------	-----------	-----------------	----------------	------------------	-------------	-------------	-------------

<b>Pulls:</b>	Brushed Chrome	<b>P \$22</b>
---------------	----------------	---------------

### 4-Drawer Lateral File

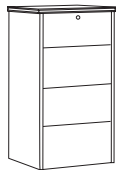

- Four lateral file drawers, letter or legal filing
- Pre-installed ProFile filing hardware
- Front central locking
- Anti-tilt allows for only one drawer to open at a time
- Finished back panel
- Hardwood bottom support rail secured with metal bracket on each end

Freight Class: 125

<b>CVC426</b>		37.75" X 24" X 54.5"	Cubic Ft: 35.5	Ship Weight: 392	<b>2492</b>	<b>2529</b>	<b>2567</b>
---------------	--	----------------------	----------------	------------------	-------------	-------------	-------------

<b>Pulls:</b>	Brushed Chrome	<b>P \$44</b>
---------------	----------------	---------------

### 65" High Bookcase

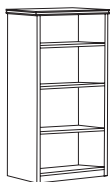

- Two adjustable shelves
- Bottom and middle shelves fixed
- All shelves are 1" thick
- Back panel is finished both sides

Freight Class: 125

<b>CVC65</b>	<b>QS</b>	36" X 14" X 65"	Cubic Ft: 31.1	Ship Weight: 150	<b>1571</b>	<b>1595</b>	<b>1618</b>
--------------	-----------	-----------------	----------------	------------------	-------------	-------------	-------------

**48" High Bookcase**



- Two adjustable shelves
- 1" thick shelves
- Concave edge profile in top
- Finished back panel

Freight Class: 125

		Zone Pricing			
		1	2	3	
<b>CVC48</b>	<b>QS</b>	36" X 14" X 48" Cubic Ft: 23.2 Ship Weight: 128	<b>1161</b>	<b>1178</b>	<b>1196</b>

**30" High Bookcase**



- One adjustable shelf
- 1" thick shelves
- Concave edge profile in top
- Finished back panel

Freight Class: 125

<b>CVC30</b>	<b>QS</b>	36" X 14" X 30" Cubic Ft: 15 Ship Weight: 85	<b>1054</b>	<b>1070</b>	<b>1086</b>
--------------	-----------	--	-------------	-------------	-------------

**Additional Items**

**Reception Screen for Main**

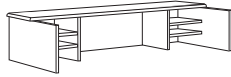

- Fits 72" x 36" desks
- Four adjustable shelves
- Non-skid rubber strips on bottom prohibit movement

Freight Class: 70

<b>CVC709</b>		72" X 36" X 14" Cubic Ft: 31.9 Ship Weight: 150	<b>2019</b>	<b>2049</b>	<b>2080</b>
---------------	--	---	-------------	-------------	-------------

**Reception Screen for Return**



- Fits 48" x 24" executive height return
- Hardware included to join to main reception screen
- 611L fits left return
- 611R fits right return
- Assembly required

Freight Class: 70

<b>CVC611L</b>		48" X 24" X 13" Cubic Ft: 1.5 Ship Weight: 27	<b>483</b>	<b>490</b>	<b>497</b>
<b>CVC611R</b>		48" X 24" X 13" Cubic Ft: 1.5 Ship Weight: 27	<b>483</b>	<b>490</b>	<b>497</b>

**Center Drawer**

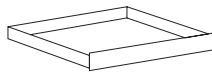

- CVC66CTRS fits 66" single pedestal desks in L-shaped & U-shaped workstations
- CVC66CTRD fits 66" double pedestal desks and credenzas
- CVC72CTRS fits 72" single pedestal desks & credenzas
- CVC72CTRD fits 72" double pedestal desks & credenzas
- Factory installation available

Freight Class: 100

<b>CVC66CTRS</b>	<b>QS</b>	21.75" X 18.75" X 3" Cubic Ft: 2.0 Ship Weight: 12	<b>274</b>	<b>278</b>	<b>282</b>
<b>CVC66CTRD</b>	<b>QS</b>	26" X 18.75" X 3" Cubic Ft: 2.0 Ship Weight: 13	<b>274</b>	<b>278</b>	<b>282</b>
<b>CVC72CTRS</b>	<b>QS</b>	27.5" X 18.75" X 3" Cubic Ft: 2.2 Ship Weight: 14	<b>287</b>	<b>291</b>	<b>296</b>
<b>CVC72CTRD</b>	<b>QS</b>	32" X 18.75" X 3" Cubic Ft: 2.0 Ship Weight: 15	<b>287</b>	<b>291</b>	<b>296</b>

**Pullout Keyboard Platform**



- Platform only
- CVCK21 requires 26" kneespace
- Fits single pedestal desks & credenzas with bridges or returns
- CVCK29 requires 31" kneespace
- Fits double pedestal desks, credenzas or bridges only
- Factory installation available

Freight Class: 92.5

<b>CVCK21</b>	<b>QS</b>	22" X 18" X 2.75" Cubic Ft: 2.0 Ship Weight: 13	<b>223</b>	<b>226</b>	<b>230</b>
<b>CVCK29</b>	<b>QS</b>	28" X 18" X 2.75" Cubic Ft: 2.0 Ship Weight: 18	<b>242</b>	<b>246</b>	<b>249</b>



## CHARACTERISTICS

Affirm veneer casegoods feature the beauty and variation of genuine select hardwood veneers. Unique grain pattern from piece to piece is a natural characteristic of genuine veneer and creates elegant furnishings, therefore HPFI does not guarantee matching grain pattern. All horizontal and vertical surfaces are veneer protected with durable catalyzed lacquer. Desk pads and/or glass with standoffs will further protect real wood surfaces. A semi-filled, satin style finish creates an elegant, understated presentation. All panels are 3-ply construction with medium density fiberboard (MDF) core and veneer top and bottom. Edges are CNC-shaped, then hand-finished to complement the collection.

## FINISH CHOICES

Affirm is offered in two finishes, complementing all other HPFI veneer collections.

- C** Honey Cherry
- M** Rouge Mahogany

Variation in color is an expected and natural characteristic of real wood. Minor variation in color may occur even with pieces finished at the same time. Aging and light exposure will darken wood. Therefore, HPFI does not guarantee exact color match.

## PEDESTALS

Choose any pedestal to customize drawer configurations to individual preference. All choices are the same price.

- 3** Box/Box/File
- 5** File/File
- 7** Left Box/Box/File & Right File/File
- 9** Left File/File & Right Box/Box/File

## PULLS: *Standard*

Affirm features an ergonomically shaped, twisted ribbon pull with smooth, nickel finish. A coordinating elliptical knob is included on overheads with all-wood doors.

## PULLS: *Alternative*

As an alternative, solid metal, curvilinear pulls are available in three colors at the same price. Specify pull designator after the drawer configuration in the model number.

- W** Brushed Chrome
- E** Ebony (black)
- B** Bright Brass

## LOCKING OPTIONAL

Locking is optional on all pedestals at \$95 list per pedestal. Specify 'Y' at the end of the model number.

- Locks are added to top right corner of top drawer of pedestal.
- All locks keyed identical unless otherwise specified. 'Key Different' option is \$21 list upcharge per lock. Locks/cores packaged to customer specifications.

- Additional lead time for 'Key Different'.
- Pricing Examples: Locking Upcharges**

- Desk with (2) Box/Box/File Pedestals  
*Add \$190 list*
- Two-Drawer Lateral File  
*Add \$95 list*
- Return with (1) File/File Pedestal  
*Add \$95 list*
- Credenza with (2) File/File Pedestals  
*Add \$190 list*

For optional locking on overhead storage units with four wood doors with no inserts, add **Y** to the end of the model number and add \$150 to the list price.

## ACCESSORIES *Factory-Installed*

Certain accessories can be ordered factory-installed prior to shipment. Specify appropriate designator at very end of model number and add correct list upcharge.

- C** Center Drawer
- K** Keyboard Platform
- T** Task Light

## WIRE MANAGEMENT

See features for number of grommets and location. Additional grommets can be added for extended wire management capability at \$106 list per grommet. Includes factory cut and installed grommet and black sleeve. Call for special quote. Specify location and quote number with order.

## SPECIFICATIONS *Case & Top*

- Tops**
- 1" thick, 3-ply balanced panel construction
- Common grain direction between desk/return/bridge credenza
- Reverse-coped edges on bridge and returns for smooth worksurface connections

### *Edges*

- Shaped MDF with reverse-step edge profile

### *Modesty Panel*

- Curved at bottom
- Slight inset; attached with black metal L brackets/screws
- 3/4" thick with veneer face and back

### *Pedestals*

- Decorative brass trim made of 1 1/8" thick solid hardwood and field replaceable
- Preinstalled leveling glides

### *Construction*

- Dowels/glue, wood cleats, metal brackets, screws and mechanical fasteners

### *Assembly*

- Fully assembled (except bridge and table)

## SPECIFICATIONS *Drawers*

### *Drawers*

- 5-sided construction with replaceable fronts
  - Fronts 3/4" thick core with veneer surfaces
- Box**
- 7/16" thick hardwood veneer interiors
- Bottom**
- 1/8" thick plywood

## SUSPENSIONS

### *Box Drawer*

- 3/4-extension, steel ball-bearing

### *File Drawer*

- Full-extension, steel ball-bearing

### *Lateral File*

- Full-extension, steel ball-bearing

## FILING

Steel and black molded polymer hardware included.

### *File Drawer*

- Legal (side-to-side) & Letter (front-to-back and side-to-side)

### *Lateral File*

- Legal (side-to-side) & Letter (front-to-back and side-to-side)

### *Capacity*

- Lateral file is built for filing
- Maximum 40 lb bottom load

## PACKAGING

All units are properly packed in heavy-duty cartons with reinforced corner pads. All packaging conforms to, or exceeds, specifications as outlined in the Uniform Freight Classification.

## PALLETIZATION

See page 3.

## CARE AND CLEANING INSTRUCTIONS FOR VENEER PRODUCTS

**Normal cleaning:** Wood veneer products require special care. When cleaning, it is important to use a quality window cleaner which contains no ammonia followed by a dry soft cloth to remove any dampness.

**Polish Suggestions:** To polish veneer furniture, we recommend that you use a quality furniture polish which contains no silicone followed by a dry soft cloth. Using a polish without silicone, will protect the everlasting beauty of this natural wood product.

**Warning** – Using a polish containing silicone may cloud the finish, soften, crack or lift the finish and void your warranty.

**Specifications subject to change without notice.**



**Configurations**

**Executive Office**

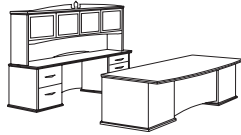

Description	Model Number	Qty	Frft.Class	Cubic Ft.	Ship Weight	Zone Pricing	1	2	3
Bow Front Double Pedestal Desk	AV700B 72" x 34" x 29"	1	200	51.6	263	<b>2505</b>	<b>2543</b>	<b>2580</b>	
Double Pedestal Credenza	AV725 72" x 24" x 29"	1	110	36.1	227	<b>2139</b>	<b>2171</b>	<b>2203</b>	
Overhead with Frosted Door Inserts	AV730 72" x 16" x 41"	1	125	35	183	<b>1564</b>	<b>1587</b>	<b>1611</b>	
Total:							<b>6208</b>	<b>6301</b>	<b>6394</b>

**Executive U with Overhead**



72" x 96" x 70"

Description	Model Number	Qty	Frft.Class	Cubic Ft.	Ship Weight	Zone Pricing	1	2	3
Right Pedestal Desk	AV700R 72" x 30" x 29"	1	200	43.5	232	<b>1955</b>	<b>1984</b>	<b>2014</b>	
Bridge	AV484 42" x 24" x 29"	1	100	4.9	63	<b>605</b>	<b>614</b>	<b>623</b>	
Left Pedestal Credenza	AV725L 72" x 24" x 29"	1	125	36.1	205	<b>1528</b>	<b>1551</b>	<b>1574</b>	
Overhead with Frosted Door Inserts	AV730 72" x 16" x 41"	1	125	35	183	<b>1564</b>	<b>1587</b>	<b>1611</b>	
Total:							<b>5652</b>	<b>5736</b>	<b>5822</b>

**Executive L**



72" x 72" x 29"

Description	Model Number	Qty	Frft.Class	Cubic Ft.	Ship Weight	Zone Pricing	1	2	3
Right Pedestal Desk	AV700R 72" x 30" x 29"	1	200	43.5	232	<b>1955</b>	<b>1984</b>	<b>2014</b>	
Left Return	AV622L 42" x 24" x 29"	1	110	21.8	122	<b>1448</b>	<b>1470</b>	<b>1491</b>	
Total:							<b>3403</b>	<b>3454</b>	<b>3505</b>

**DESKS Double Pedestal**

**Bow Front Double Pedestal Desk**



Pedestal Option Shown: 3

Freight Class: 200

- Bow front top
- 11.5" conference overhang
- Curved modesty panel
- Legal or letter filing

<b>AV700B</b> _ _	72" X 34" X 29"	Cubic Ft: 51.6	Ship Weight: 263	<b>2505</b>	<b>2543</b>	<b>2580</b>
	<b>Center Drawer C</b>			213	216	219
	<b>Keyboard Platform K</b>			185	188	191
<b>Pedestal:</b>	Box/Box/File <b>3</b>	File/File <b>5</b>	Left B/B/F, Right F/F <b>7</b>	Left F/F, Right B/B/F <b>9</b>		
				<b>Locks</b>	\$190:	<b>Y</b>

**Double Pedestal Desk**



Pedestal Option Shown: 3

Freight Class: 110

- 7.5" conference overhang
- Curved modesty panel
- Legal or letter filing

<b>AV700</b> _ _	72" X 30" X 29"	Cubic Ft: 43.5	Ship Weight: 254	<b>2322</b>	<b>2357</b>	<b>2392</b>
	<b>Center Drawer C</b>			213	216	219
	<b>Keyboard Platform K</b>			185	188	191
<b>AV660</b> _ _	66" X 30" X 29"	Cubic Ft: 40.2	Ship Weight: 246	<b>2261</b>	<b>2295</b>	<b>2329</b>
	<b>Center Drawer C</b>			213	216	219
	<b>Keyboard Platform K</b>			185	188	191
<b>Pedestal:</b>	Box/Box/File <b>3</b>	File/File <b>5</b>	Left B/B/F, Right F/F <b>7</b>	Left F/F, Right B/B/F <b>9</b>		
				<b>Locks</b>	\$190:	<b>Y</b>

CONTEMPORARY VENEER



AV700RB **C 3**  
 Finish Pedestal

## Single Pedestal & Table

Zone Pricing	1	2	3
--------------	---	---	---

### Bow Front Single Pedestal Desk

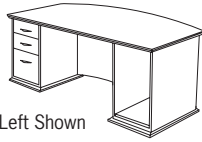

Left Shown

- Bow front top
- 11.5" conference overhang
- Curved modesty panel
- Legal or letter filing
- Open storage pedestal with grommet in kneespace

Freight Class: 200

<b>AV700RB</b> _ _ 72" X 34" X 29" Cubic Ft: 51.6 Ship Weight: 241	<b>2139</b>	<b>2171</b>	<b>2203</b>
<b>Center Drawer C</b>	213	216	219
<b>Keyboard Platform K</b>	185	188	191
<b>AV700LB</b> _ _ 72" X 34" X 29" Cubic Ft: 51.6 Ship Weight: 241	<b>2139</b>	<b>2171</b>	<b>2203</b>
<b>Center Drawer C</b>	213	216	219
<b>Keyboard Platform K</b>	185	188	191
<b>Pedestal:</b> Box/Box/File <b>3</b> File/File <b>5</b>	<b>Locks</b>	\$95: <b>Y</b>	

### Single Pedestal Desk

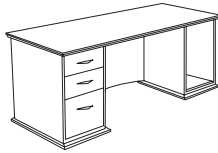

Right Pedestal Desk  
Pedestal Option Shown: 3

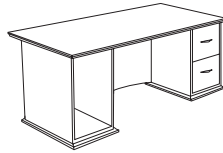

Left Pedestal Desk  
Pedestal Option Shown: 5

- Rectangular top
- 7.5" conference overhang
- Curved modesty panel
- Legal or letter filing
- Open storage pedestal with grommet in kneespace

Freight Class: 200

<b>AV700R</b> _ _ 72" X 30" X 29" Cubic Ft: 43.5 Ship Weight: 232	<b>1955</b>	<b>1984</b>	<b>2014</b>
<b>Center Drawer C</b>	213	216	219
<b>Keyboard Platform K</b>	185	188	191
<b>AV700L</b> _ _ 72" X 30" X 29" Cubic Ft: 43.5 Ship Weight: 232	<b>1955</b>	<b>1984</b>	<b>2014</b>
<b>Center Drawer C</b>	213	216	219
<b>Keyboard Platform K</b>	185	188	191
<b>AV660R</b> _ _ 66" X 30" X 29" Cubic Ft: 40.2 Ship Weight: 224	<b>1895</b>	<b>1923</b>	<b>1952</b>
<b>Center Drawer C</b>	213	216	219
<b>Keyboard Platform K</b>	185	188	191
<b>AV660L</b> _ _ 66" X 30" X 29" Cubic Ft: 40.2 Ship Weight: 224	<b>1895</b>	<b>1923</b>	<b>1952</b>
<b>Center Drawer C</b>	213	216	219
<b>Keyboard Platform K</b>	185	188	191
<b>Pedestal:</b> Box/Box/File <b>3</b> File/File <b>5</b>	<b>Locks</b>	\$95: <b>Y</b>	

### Table Desk, Tapered Leg

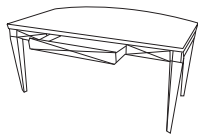

Freight Class: 125

- Tapered legs
- Keyboard drawer with drop-down front
- Assembly Required

<b>AV602</b> _ 66" X 30" X 30.5" Cubic Ft: 15 Ship Weight: 132	<b>1304</b>	<b>1324</b>	<b>1343</b>
<b>AV702</b> _ 72" X 30" X 30.5" Cubic Ft: 15 Ship Weight: 140	<b>1422</b>	<b>1443</b>	<b>1465</b>
<b>AV702B</b> _ 72" X 34" X 30.5" Cubic Ft: 15 Ship Weight: 148	<b>1542</b>	<b>1565</b>	<b>1588</b>

## Credenzas, Returns & Bridge

### Double Pedestal Credenza

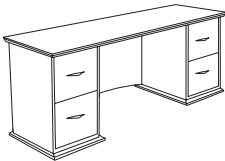

- Curved modesty panel
- Legal or letter filing
- One grommet in modesty panel

Freight Class: 110

<b>AV725</b> _ _ 72" X 24" X 29" Cubic Ft: 36.1 Ship Weight: 227	<b>2139</b>	<b>2171</b>	<b>2203</b>
<b>Center Drawer C</b>	213	216	219
<b>Keyboard Platform K</b>	185	188	191
<b>AV625</b> _ _ 66" X 24" X 29" Cubic Ft: 33.2 Ship Weight: 219	<b>2078</b>	<b>2109</b>	<b>2140</b>
<b>Center Drawer C</b>	213	216	219
<b>Keyboard Platform K</b>	185	188	191
<b>Pedestal:</b> Box/Box/File <b>3</b> File/File <b>5</b> Left B/B/F, Right F/F <b>7</b> Left F/F, Right B/B/F <b>9</b>	<b>Locks</b>	\$190: <b>Y</b>	

### Single Pedestal Credenza

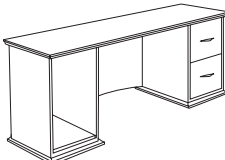

Right Pedestal Credenza  
Pedestal Option Shown: 5

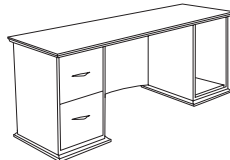

Left Pedestal Credenza

- Curved modesty panel
- Legal or letter filing
- Open storage pedestal with grommet in kneespace
- One grommet in modesty panel

Freight Class: 125

<b>AV725R</b> _ _ 72" X 24" X 29" Cubic Ft: 36.1 Ship Weight: 205	<b>1528</b>	<b>1551</b>	<b>1574</b>
<b>Keyboard Platform K</b>	185	188	191
<b>AV725L</b> _ _ 72" X 24" X 29" Cubic Ft: 36.1 Ship Weight: 205	<b>1528</b>	<b>1551</b>	<b>1574</b>
<b>Keyboard Platform K</b>	185	188	191
<b>AV625R</b> _ _ 66" X 24" X 29" Cubic Ft: 33.2 Ship Weight: 199	<b>1467</b>	<b>1489</b>	<b>1511</b>
<b>Keyboard Platform K</b>	185	188	191
<b>AV625L</b> _ _ 66" X 24" X 29" Cubic Ft: 33.2 Ship Weight: 199	<b>1467</b>	<b>1489</b>	<b>1511</b>
<b>Keyboard Platform K</b>	185	188	191
<b>Pedestal:</b> Box/Box/File <b>3</b> File/File <b>5</b>	<b>Locks</b>	\$95: <b>Y</b>	

FINISH SELECTION

HONEY CHERRY C | ROUGE MAHOGANY M |

SIN 711-8 **AFFIRM**

**Lateral File Credenza**

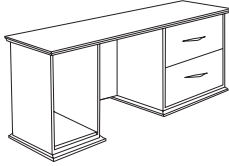

Right Lateral File Credenza

- Two lateral file drawers
- Legal or letter filing

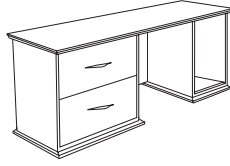

Left Lateral File Credenza

- Open storage pedestal with grommet in kneespace
- Rectangular modesty panel only

Freight Class: 125

**Return**

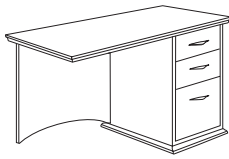

Right Return  
Pedestal Option Shown: 3

- Curved modesty panel
- Common grain direction with desks/credenzas
- Reversed coped edges for smooth connections

Freight Class: 110

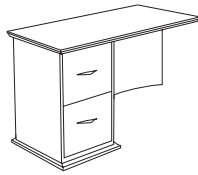

Left Return  
Pedestal Option Shown: 5

- Legal or letter filing
- One grommet in modesty panel

**Bridge**

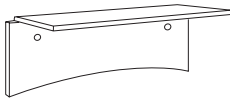

Freight Class: 100

- Curved modesty panel
- Common grain direction with desks/credenzas
- Reversed coped edges for smooth connections
- Two wire management grommets

**Overhead Storage**

**Overhead Storage, Wood Doors with Frosted Inserts**

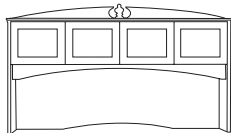

- Two storage compartments
- Four wood doors with frosted inserts
- Integral wire management
- Crown decor and finial are attached in the field
- Includes light rail

Freight Class: 125

**Overhead Storage, Wood Doors**

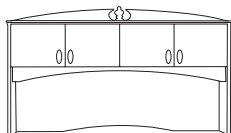

- Two storage compartments
- Four wood doors
- Integral wire management
- Crown decor and finial are attached in the field
- Includes light rail

Freight Class: 125

Zone Pricing

1

2

3

<b>AV733R_</b>	72" X 24" X 29"	Cubic Ft: 36.1	Ship Weight: 250	<b>1680</b>	<b>1705</b>	<b>1730</b>
<b>AV733L_</b>	72" X 24" X 29"	Cubic Ft: 36.1	Ship Weight: 250	<b>1680</b>	<b>1705</b>	<b>1730</b>
<b>AV633R_</b>	66" X 24" X 29"	Cubic Ft: 33.2	Ship Weight: 242	<b>1620</b>	<b>1644</b>	<b>1669</b>
<b>AV633L_</b>	66" X 24" X 29"	Cubic Ft: 33.2	Ship Weight: 242	<b>1620</b>	<b>1644</b>	<b>1669</b>

Locks \$95: Y

<b>AV622R_</b>	42" X 24" X 29"	Cubic Ft: 21.8	Ship Weight: 122	<b>1448</b>	<b>1470</b>	<b>1491</b>
				<b>Keyboard Platform K</b>	185	188
<b>AV622L_</b>	42" X 24" X 29"	Cubic Ft: 21.8	Ship Weight: 122	<b>1448</b>	<b>1470</b>	<b>1491</b>
				<b>Keyboard Platform K</b>	185	188

Pedestal: Box/Box/File 3 File/File 5 Locks \$95: Y

<b>AV484_</b>	42" X 24" X 29"	Cubic Ft: 4.9	Ship Weight: 63	<b>605</b>	<b>614</b>	<b>623</b>
---------------	-----------------	---------------	-----------------	------------	------------	------------

<b>AV730_</b>	72" X 16" X 41"	Cubic Ft: 35	Ship Weight: 183	<b>1564</b>	<b>1587</b>	<b>1611</b>
				<b>Task Light I</b>	124	126
				<b>LED Task Light L</b>	212	215
<b>AV630_</b>	66" X 16" X 41"	Cubic Ft: 28.3	Ship Weight: 163	<b>1504</b>	<b>1527</b>	<b>1549</b>
				<b>Task Light I</b>	124	126
				<b>LED Task Light L</b>	212	215

<b>AV729_</b>	72" X 16" X 41"	Cubic Ft: 34.4	Ship Weight: 181	<b>1564</b>	<b>1587</b>	<b>1611</b>
				<b>Task Light I</b>	124	126
				<b>LED Task Light L</b>	212	215
<b>AV629_</b>	66" X 16" X 41"	Cubic Ft: 28.3	Ship Weight: 161	<b>1504</b>	<b>1527</b>	<b>1549</b>
				<b>Task Light I</b>	124	126
				<b>LED Task Light L</b>	212	215

Locks \$150: Y

CONTEMPORARY VENEER



## Bookcase Hutch, File & Table

Zone Pricing

1

2

3

### Bookcase Hutch



Freight Class: 125

- Two adjustable bookshelves
- Fits on two-drawer lateral file

<b>AV317_</b>	33" X 16" X 36.5"	Cubic Ft: 15.3	Ship Weight: 95	<b>824</b>	<b>836</b>	<b>849</b>
---------------	-------------------	----------------	-----------------	------------	------------	------------

### Two-Drawer Lateral File

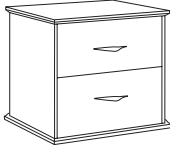

Freight Class: 125

- Two lateral file drawers
- Legal or letter filing
- Filing hardware included

<b>AV346_</b>	33" X 24" X 29"	Cubic Ft: 14	Ship Weight: 132	<b>1223</b>	<b>1241</b>	<b>1260</b>
---------------	-----------------	--------------	------------------	-------------	-------------	-------------

Locks \$95: **Y**

### Round Table



Freight Class: 400

- Round veneer top
- Black metal base
- Ships in two cartons
- Easy to assemble

<b>AVR36_</b>	36" X 29"	Cubic Ft: 13.9	Ship Weight: 62	<b>605</b>	<b>614</b>	<b>623</b>
---------------	-----------	----------------	-----------------	------------	------------	------------

## Center Drawers & Keyboard Platforms

### Center Drawer

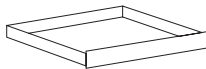

Freight Class: 100

- GVCD38\_ Fits 72" double pedestal desks & credenzas
- GVCD32\_ Fits 66" double pedestal desks & credenzas
- GVCD30\_ Fits 72" single pedestal desks & credenzas
- GVCD25\_ Fits 66" single pedestal desks & credenzas

<b>GVCD38_</b>	38" X 18" X 3"	Cubic Ft: 2.4	Ship Weight: 13.5	<b>213</b>	<b>216</b>	<b>219</b>
<b>GVCD32_</b>	32" X 18" X 3"	Cubic Ft: 2.4	Ship Weight: 13	<b>213</b>	<b>216</b>	<b>219</b>
<b>GVCD30_</b>	30.5" X 18" X 3"	Cubic Ft: 2.4	Ship Weight: 13	<b>213</b>	<b>216</b>	<b>219</b>
<b>GVCD25_</b>	24.5" X 18" X 3"	Cubic Ft: 2.4	Ship Weight: 12	<b>213</b>	<b>216</b>	<b>219</b>

### Keyboard Platform

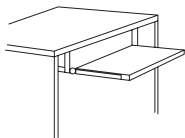

Freight Class: 92.5

- Platform only
- GVK21\_ Fits single pedestal desks, credenzas and returns
- GVK29\_ Fits double pedestal desks, credenzas and returns

<b>GVK29_</b>	28" X 18" X 2.75"	Cubic Ft: 1.3	Ship Weight: 18	<b>185</b>	<b>188</b>	<b>191</b>
<b>GVK21_</b>	22" X 18" X 2.75"	Cubic Ft: 1.3	Ship Weight: 13	<b>185</b>	<b>188</b>	<b>191</b>

## CHARACTERISTICS

Legacy features **Rouge Mahogany** finish on book matched American Cherry veneer. All horizontal and vertical surfaces feature Full-Fill finish. Catalyzed lacquer topcoat creates harder, more durable finish and includes high sheen. Desk pad or glass with stand-offs will further protect veneer tops. Worksurface dimensions will vary due to edge profile treatment. Always measure actual worksurface before ordering glass or other top to fit unit.

## FINISH CHOICE

**M** Rouge Mahogany

## IMPORTANT NOTE

Because of the natural characteristics of wood, color may vary slightly between pieces. Color will mellow and age over time.

## CONSTRUCTION

All panels are 5-ply construction with commercial-grade coreboard center and two veneer sheets top and bottom. Veneer is cross-grained for strength. Preinstalled leveling glides.

## PEDESTALS, CREDENZAS, FILE CABINETS AND STORAGE UNITS

All cases are ¾" thick core surfaced with cherry veneer and edge banded as required. Units assembled using tongue & groove construction. Most models feature full modesty panels. Inset drawer fronts available at \$53 list per pedestal; specify **NC** at front of model number. Molding is standard on these selections. Standard leadtime only.

## TOPS

High pressure laminate top features the same tops as in the Bedford Series, which has a solid hardwood edge with a slightly different profile than the wood veneer top. Round table top utilizes composite edge.

**LVM Models:** All LVM case tops are 1<sup>3</sup>/<sub>16</sub>" thick with cherry veneer, properly backed, and have solid hardwood edges.

**LVM & LPM Models:** All bridge and return tops feature common grain direction with desk/credenza as well as reverse coped edges for smooth work surface connection with desk/credenza.

**LPM Models:** All units, except bookcases and hutches, can be ordered with a high gloss, high pressure laminate top by specifying LPM. *Example: LPM720.*

## DRAWERS

All drawer fronts are constructed of ¾" thick MDF core surfaced in cherry veneer. Drawer sides are ½" thick hardwood veneer interiors in light lacquer finish with

veneer top edges. Drawer bottoms are ¼" thick hardwood veneer

- All box drawers are suspended on smooth action metal slides with steel ball bearings
- All file drawers and file cabinet drawers are mounted on heavy-duty steel ball bearing, full extension slides
- Black ProFile filing hardware includes pre-installed rails with adjustable crossbars that lock into position
- All file drawers allow letter filing front-to-back and side-to-side; legal filing side-to-side
- All lateral file drawers allow letter and/or legal filing front-to-back and legal filing side-to-side
- Maximum weight for bottom loading 40 lb
- Drawers are constructed with 5 sides for extra strength and durability. The drawer front is the 5th side and is removable in the field for repairs or hardware additions

## WRITING SLIDES

Pull-out writing slides are included on all drawer pedestals on desks, credenzas and returns.

## WIRE MANAGEMENT

See features for number of grommets and location. Additional grommets can be added for extended wire management capability at \$106 list per grommet. Includes factory cut and installed grommet and black sleeve. Call for special quote. Specify location and quote number with order.

## HARDWARE

Pulls and knobs are a beautiful traditional design, solid metal with a brass finish to complement Legacy.

## LOCKS

- Independent fully locking pedestals are standard on all credenzas and desks
- Two drawer lateral files feature individually locking drawers.
- Four drawer lateral files feature central locking and are keyed different than other locks due to the anti-tilt mechanism inside the unit
- All locks are keyed identical unless otherwise specified
- 'Key Different' option is \$21 list upcharge per lock. Locks/cores packaged to customer requirements
- Additional lead time for 'Key Different'. For optional locking on overhead storage units with four wood doors, add **Y** to the end of the model number and add \$150 to the list price of unit

## DIMENSIONS

All size dimensions are nominal and subject to change. If you must have exact

dimensions, please contact your Customer Service Representative. Worksurface dimensions will vary due to edge profile treatment. Always measure actual top before ordering glass or other cover to fit tops.

## ACCESSORIES *Factory Installed*

Certain accessories can be ordered installed prior to shipment. Add letter designator (K or C) at end of the desk, credenza or overhead model number:

- K** Keyboard Platform  
*Example: LVM725LK*
- C** Center Drawer  
*Example: LVM725LC*

## OPTIONAL MOLDING

Optional picture frame molding (**DX**) is available. Please call customer service for more information.

## QUICKSHIP

Quick Ship is not available on any items ordered with option.

## PACKING

All units are properly packed in heavy-duty cartons with reinforced corner pads. All packaging conforms to, or exceeds specifications as outlined in the Uniform Freight Classification. All desks, credenzas, files and overhead storage units are shipped preassembled. Modular L- and U-Shaped workstations are shipped in multiple cartons, requiring connection.

## PALLETIZATION

Casegood products may be palletized prior to shipment for enhanced protection and further assurance of safe delivery. Pallets are one per product, in most cases, and sized per product. Palletization is \$21 net per pallet. Contact Customer Service for additional details.

## CARE & CLEANING INSTRUCTIONS

**Normal cleaning:** Wood veneer products require special care. When cleaning, it is important to use a quality window cleaner which contains no ammonia followed by a dry soft cloth to remove any dampness.

**Polish Suggestions:** To polish veneer furniture, we recommend that you use a quality furniture polish which contains no silicone followed by a dry soft cloth. Using a polish without silicone, will protect the everlasting beauty of this natural wood product.

**Warning:** Using a polish containing silicone may cloud the finish, soften, crack or lift the finish and void your warranty.

**Specifications subject to change without notice.**





## Configurations

Zone Pricing

1

2

3

### Computer Workstation



72" x 24" x 76"

Description	Model Number	Qty	Frft.Class	Cubic Ft.	Ship Weight	1	2	3
Left Pedestal Credenza	LVM725L 72" x 24" x 30"	1	125	35.7	230	2594	2633	2672
Hutch for Computer Credenza	LVM727 72" x 17" x 46"	1	125	43.6	219	2478	2515	2552
Pull-Out Keyboard Platform	LVMK35 29" x 18"	1	92.5	3.0	17	242	246	249
Total:						5314	5394	5473

### L-Shaped Workstation



72" x 83" x 30"

Description	Model Number	Qty	Frft.Class	Cubic Ft.	Ship Weight	1	2	3
Right Pedestal Desk	LVM721R 72" x 36" x 30"	1	200	51.6	276	3130	3177	3224
Left Pedestal Return	LVM722L 48" x 24" x 30"	1	110	25.3	145	1876	1904	1932
Total:						5006	5081	5156

### U-Shaped Workstation

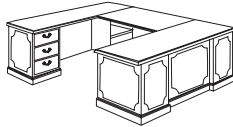

72" x 106" x 30"

Description	Model Number	Qty	Frft.Class	Cubic Ft.	Ship Weight	1	2	3
Right Pedestal Desk with Deluxe Traditional Molding	LVM721RDX 72" x 36" x 30"	1	200	51.6	276	3252	3301	3350
Left Pedestal Credenza with Deluxe Traditional Molding	LVM725LDX 72" x 24" x 30"	1	125	35.7	230	2716	2757	2797
Desk Height Bridge	LVM485 48" x 24" x 30"	1	100	4.0	68	844	857	869
Total:						6812	6915	7016

### Reception Station

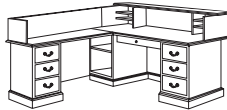

72" x 83" x 44"

Description	Model Number	Qty	Frft.Class	Cubic Ft.	Ship Weight	1	2	3
Right Pedestal Desk	LVM721R 72" x 36" x 30"	1	200	51.6	276	3130	3177	3224
Left Pedestal Return	LVM722L 48" x 24" x 30"	1	110	25.3	145	1876	1904	1932
Reception Screen Main	LVM710 72" x 35" x 14"	1	70	31.9	140	1928	1957	1986
Left Reception Screen Return	LVM711L 47" x 22" x 13"	1	70	1.5	27	474	481	488
Total:						7408	7519	7630

## Desks

### Double Pedestal Desk



Freight Class: 110

- Two box drawers
- Two file drawers, letter or legal filing
- Two pull-out writing slides
- Center drawer
- LPM - HPL top
- LVM - Wood veneer top
- DX - Picture frame molding
- Central locking

LVM660DX	QS	66" X 30" X 30"	Cubic Ft: 40.2	Ship Weight: 259	3363	3413	3464
LVM660	QS	66" X 30" X 30"	Cubic Ft: 40.2	Ship Weight: 259	3240	3289	3337
LPM660DX		66" X 30" X 30"	Cubic Ft: 40.2	Ship Weight: 259	3363	3413	3464
LPM660		66" X 30" X 30"	Cubic Ft: 40.2	Ship Weight: 259	3240	3289	3337
LPM600DX		60" X 30" X 30"	Cubic Ft: 36.7	Ship Weight: 244	3349	3399	3449
LPM600		60" X 30" X 30"	Cubic Ft: 36.7	Ship Weight: 244	3227	3275	3324

### Double Pedestal Desk



Freight Class: 200

- Two box drawers
- Two file drawers, letter or legal filing
- Two pull-out writing slides
- Center drawer standard
- Central locking
- LPM - HPL top
- LVM - Wood veneer top
- DX - Picture frame molding

LVM751DX	QS	78" X 42" X 30"	Cubic Ft: 67.9	Ship Weight: 320	4675	4745	4815
LVM751	QS	78" X 42" X 30"	Cubic Ft: 67.9	Ship Weight: 320	4553	4621	4690
LPM751DX		78" X 42" X 30"	Cubic Ft: 67.9	Ship Weight: 320	4675	4745	4815
LPM751		78" X 42" X 30"	Cubic Ft: 67.9	Ship Weight: 320	4553	4621	4690
LVM720DX	QS	72" X 36" X 30"	Cubic Ft: 51.6	Ship Weight: 295	3491	3543	3596
LVM720	QS	72" X 36" X 30"	Cubic Ft: 51.6	Ship Weight: 295	3369	3420	3470
LPM720DX		72" X 36" X 30"	Cubic Ft: 51.6	Ship Weight: 295	3491	3543	3596
LPM720		72" X 36" X 30"	Cubic Ft: 51.6	Ship Weight: 295	3369	3420	3470

**Left Pedestal Desk**



- One box drawer
- One file drawer, letter or legal filing
- One pull-out writing slide
- Center drawer standard
- Central locking
- Open storage with adjustable shelf
- One grommet in open storage pedestal
- LPM - HPL top
- LVM - Wood veneer top
- DX - Picture frame molding

		Zone Pricing		1	2	3
<b>LVM721LDX QS</b>	72" X 36" X 30" Cubic Ft: 51.6 Ship Weight: 276	<b>3252</b>	<b>3301</b>	<b>3350</b>		
Freight Class: 200						
<b>LVM721L QS</b>	72" X 36" X 30" Cubic Ft: 51.6 Ship Weight: 276	<b>3130</b>	<b>3177</b>	<b>3224</b>		
Freight Class: 200						
<b>LVM651LDX QS</b>	66" X 30" X 30" Cubic Ft: 40.2 Ship Weight: 240	<b>3122</b>	<b>3169</b>	<b>3216</b>		
Freight Class: 110						
<b>LVM651L QS</b>	66" X 30" X 30" Cubic Ft: 40.2 Ship Weight: 240	<b>2999</b>	<b>3044</b>	<b>3089</b>		
Freight Class: 110						
<b>LPM721LDX</b>	72" X 36" X 30" Cubic Ft: 51.6 Ship Weight: 276	<b>3252</b>	<b>3301</b>	<b>3350</b>		
Freight Class: 200						
<b>LPM721L</b>	72" X 36" X 30" Cubic Ft: 51.6 Ship Weight: 276	<b>3130</b>	<b>3177</b>	<b>3224</b>		
Freight Class: 200						
<b>LPM651LDX</b>	66" X 30" X 30" Cubic Ft: 40.2 Ship Weight: 240	<b>3122</b>	<b>3169</b>	<b>3216</b>		
Freight Class: 110						
<b>LPM651L</b>	66" X 30" X 30" Cubic Ft: 40.2 Ship Weight: 240	<b>2999</b>	<b>3044</b>	<b>3089</b>		
Freight Class: 110						

**Right Pedestal Desk**



- One box drawer
- One file drawer, letter or legal filing
- One pull-out writing slide
- Center drawer
- Central locking
- Open storage with adjustable shelf
- Wire management grommet in open storage pedestal
- LPM - HPL top
- LVM - Wood veneer top
- DX - Picture frame molding

<b>LVM721RDX QS</b>	72" X 36" X 30" Cubic Ft: 51.6 Ship Weight: 276	<b>3252</b>	<b>3301</b>	<b>3350</b>		
Freight Class: 200						
<b>LVM721R QS</b>	72" X 36" X 30" Cubic Ft: 51.6 Ship Weight: 276	<b>3130</b>	<b>3177</b>	<b>3224</b>		
Freight Class: 200						
<b>LVM651RDX QS</b>	66" X 30" X 30" Cubic Ft: 40.2 Ship Weight: 240	<b>3122</b>	<b>3169</b>	<b>3216</b>		
Freight Class: 110						
<b>LVM651R QS</b>	66" X 30" X 30" Cubic Ft: 40.2 Ship Weight: 240	<b>2999</b>	<b>3044</b>	<b>3089</b>		
Freight Class: 110						
<b>LPM721RDX</b>	72" X 36" X 30" Cubic Ft: 51.6 Ship Weight: 276	<b>3252</b>	<b>3301</b>	<b>3350</b>		
Freight Class: 200						
<b>LPM721R</b>	72" X 36" X 30" Cubic Ft: 51.6 Ship Weight: 276	<b>3130</b>	<b>3177</b>	<b>3224</b>		
Freight Class: 200						
<b>LPM651RDX</b>	66" X 30" X 30" Cubic Ft: 40.2 Ship Weight: 240	<b>3122</b>	<b>3169</b>	<b>3216</b>		
Freight Class: 110						
<b>LPM651R</b>	66" X 30" X 30" Cubic Ft: 40.2 Ship Weight: 240	<b>2999</b>	<b>3044</b>	<b>3089</b>		
Freight Class: 110						

**Table Desk Queen Anne Leg**



- Rouge Mahogany finish on LVM
- Mahogany finish on LPM
- Rectangular top
- Queen Anne legs
- Keyboard drawer with drop-down front
- Assembly required
- LPM - HPL top
- LVM - Wood veneer top

Freight Class: 125

<b>LVM602 QS</b>	66" X 30" X 30.75" Cubic Ft: 15 Ship Weight: 132	<b>1542</b>	<b>1565</b>	<b>1588</b>		
<b>LPM602 QS</b>	66" X 30" X 30.75" Cubic Ft: 15 Ship Weight: 132	<b>1542</b>	<b>1565</b>	<b>1588</b>		

UNIT	KNEESPACE	OVERHANG
78" Double Pedestal Desk	38"	14"
72" Double Pedestal Desk	38"	8"
66" Double Pedestal Desk	32"	2"
60" Double Pedestal Desk	24-3/4"	2"
72" Double Pedestal Credenza	38"	n/a
66" Double Pedestal Credenza	32"	n/a

TRADITIONAL VENEER



## Credenzas

Zone Pricing

1

2

3

### Storage Credenza



- Two box drawers
- Two file drawers, letter or legal filing
- Two pull-out writing slides
- Individually front locking pedestals
- Storage compartment has one adjustable shelf
- Hinged front opening doors
- LPM - HPL top
- LVM - Wood veneer top
- DX - Picture frame molding

Freight Class: 125

<b>LVM704DX</b>	<b>QS</b>	72" X 24" X 30"	Cubic Ft: 35.7	Ship Weight: 278	<b>3682</b>	<b>3737</b>	<b>3792</b>
<b>LVM704</b>	<b>QS</b>	72" X 24" X 30"	Cubic Ft: 35.7	Ship Weight: 278	<b>3559</b>	<b>3612</b>	<b>3666</b>
<b>LPM704DX</b>		72" X 24" X 30"	Cubic Ft: 35.7	Ship Weight: 278	<b>3682</b>	<b>3737</b>	<b>3792</b>
<b>LPM704</b>		72" X 24" X 30"	Cubic Ft: 35.7	Ship Weight: 278	<b>3559</b>	<b>3612</b>	<b>3666</b>

### Computer Credenza



- Two box drawers
- Two file drawers, letter or legal filing
- Two pull-out writing slides
- Pull-out keyboard platform
- Individually locking pedestals
- Grommet in center modesty panel
- LPM - HPL top
- LVM - Wood veneer top
- DX - Picture frame molding

Freight Class: 110

<b>LVM744DX</b>	<b>QS</b>	72" X 24" X 30"	Cubic Ft: 35.7	Ship Weight: 250	<b>3275</b>	<b>3324</b>	<b>3373</b>
<b>LVM744</b>	<b>QS</b>	72" X 24" X 30"	Cubic Ft: 35.7	Ship Weight: 250	<b>3153</b>	<b>3200</b>	<b>3248</b>
<b>LPM744DX</b>		72" X 24" X 30"	Cubic Ft: 35.7	Ship Weight: 250	<b>3275</b>	<b>3324</b>	<b>3373</b>
<b>LPM744</b>		72" X 24" X 30"	Cubic Ft: 35.7	Ship Weight: 250	<b>3153</b>	<b>3200</b>	<b>3248</b>

### Computer Credenza



- Two box drawers
- Two file drawers, letter or legal filing
- Two pull-out writing slides
- Individually locking pedestals
- Pull-out keyboard platform
- Grommet in center modesty panel
- LPM - HPL top
- LVM - Wood veneer top
- DX - Picture frame molding

Freight Class: 110

<b>LVM644</b>	<b>QS</b>	66" X 24" X 30"	Cubic Ft: 32.8	Ship Weight: 237	<b>2841</b>	<b>2884</b>	<b>2926</b>
<b>LVM644DX</b>	<b>QS</b>	66" X 24" X 30"	Cubic Ft: 32.8	Ship Weight: 237	<b>2963</b>	<b>3007</b>	<b>3052</b>
<b>LPM644</b>		66" X 24" X 30"	Cubic Ft: 32.8	Ship Weight: 237	<b>2841</b>	<b>2884</b>	<b>2926</b>
<b>LPM644DX</b>		66" X 24" X 30"	Cubic Ft: 32.8	Ship Weight: 237	<b>2963</b>	<b>3007</b>	<b>3052</b>

### Kneespace Credenza



- Two box drawers
- Two file drawers, letter or legal filing
- Two pull-out writing slides
- Standard center drawer
- Individually locking pedestals
- LPM - HPL top
- LVM - Wood veneer top
- DX - Picture frame molding
- Grommet in center modesty panel

Freight Class: 110

<b>LVM744C</b>	<b>QS</b>	72" X 24" X 30"	Cubic Ft: 35.7	Ship Weight: 246	<b>3165</b>	<b>3212</b>	<b>3260</b>
<b>LVM744CDX</b>	<b>QS</b>	72" X 24" X 30"	Cubic Ft: 35.7	Ship Weight: 246	<b>3287</b>	<b>3336</b>	<b>3386</b>
<b>LPM744C</b>		72" X 24" X 30"	Cubic Ft: 35.7	Ship Weight: 246	<b>3165</b>	<b>3212</b>	<b>3260</b>
<b>LPM744CDX</b>		72" X 24" X 30"	Cubic Ft: 35.7	Ship Weight: 246	<b>3287</b>	<b>3336</b>	<b>3386</b>

### Kneespace Credenza



- Two box drawers
- Two file drawers, letter or legal filing
- Two pull-out writing slides
- Standard center drawer
- Individually locking pedestals
- LPM - HPL top
- LVM - Wood veneer top
- DX - Picture frame molding
- Grommet in center modesty panel

Freight Class: 110

<b>LVM644C</b>	<b>QS</b>	66" X 24" X 30"	Cubic Ft: 32.8	Ship Weight: 237	<b>3127</b>	<b>3174</b>	<b>3221</b>
<b>LVM644CDX</b>	<b>QS</b>	66" X 24" X 30"	Cubic Ft: 32.8	Ship Weight: 237	<b>3249</b>	<b>3298</b>	<b>3346</b>
<b>LPM644C</b>		66" X 24" X 30"	Cubic Ft: 32.8	Ship Weight: 237	<b>3127</b>	<b>3174</b>	<b>3221</b>
<b>LPM644CDX</b>		66" X 24" X 30"	Cubic Ft: 32.8	Ship Weight: 237	<b>3249</b>	<b>3298</b>	<b>3346</b>

**Left Lateral File Credenza**

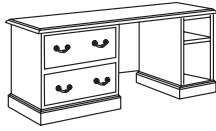

- Two lateral file drawers
- Letter or legal filing
- PROFile hardware pre-installed
- Front locking pedestal
- Connects with bridge/desk
- Open storage with adjustable shelf
- LPM - HPL top
- LVM - Wood veneer top
- DX - Picture frame molding

				Zone Pricing	1	2	3
<b>LVM733L</b>	<b>QS</b>	72" X 24" X 30"	Cubic Ft: 35.7	Ship Weight: 239	<b>2666</b>	<b>2706</b>	<b>2746</b>
<b>LVM733LDX</b>	<b>QS</b>	72" X 24" X 30"	Cubic Ft: 35.7	Ship Weight: 239	<b>2788</b>	<b>2830</b>	<b>2872</b>
<b>LPM733L</b>		72" X 24" X 30"	Cubic Ft: 35.7	Ship Weight: 239	<b>2666</b>	<b>2706</b>	<b>2746</b>
<b>LPM733LDX</b>		72" X 24" X 30"	Cubic Ft: 35.7	Ship Weight: 239	<b>2788</b>	<b>2830</b>	<b>2872</b>
<b>LVM633L</b>	<b>QS</b>	66" X 24" X 30"	Cubic Ft: 32.8	Ship Weight: 229	<b>2541</b>	<b>2579</b>	<b>2617</b>
<b>LVM633LDX</b>	<b>QS</b>	66" X 24" X 30"	Cubic Ft: 32.8	Ship Weight: 229	<b>2663</b>	<b>2703</b>	<b>2743</b>
<b>LPM633L</b>		66" X 24" X 30"	Cubic Ft: 32.8	Ship Weight: 229	<b>2541</b>	<b>2579</b>	<b>2617</b>
<b>LPM633LDX</b>		66" X 24" X 30"	Cubic Ft: 32.8	Ship Weight: 229	<b>2663</b>	<b>2703</b>	<b>2743</b>

Freight Class: 125

**Right Lateral File Credenza**



- Two lateral file drawers
- Letter or legal filing
- Front locking pedestal
- Connects with bridge/desk
- Open storage with adjustable shelf
- LPM - HPL top
- LVM - Wood veneer top
- DX - Picture frame molding

<b>LVM733R</b>	<b>QS</b>	72" X 24" X 30"	Cubic Ft: 35.7	Ship Weight: 239	<b>2666</b>	<b>2706</b>	<b>2746</b>
<b>LVM733RDX</b>	<b>QS</b>	72" X 24" X 30"	Cubic Ft: 35.7	Ship Weight: 239	<b>2788</b>	<b>2830</b>	<b>2872</b>
<b>LPM733R</b>		72" X 24" X 30"	Cubic Ft: 35.7	Ship Weight: 239	<b>2666</b>	<b>2706</b>	<b>2746</b>
<b>LPM733RDX</b>		72" X 24" X 30"	Cubic Ft: 35.7	Ship Weight: 239	<b>2788</b>	<b>2830</b>	<b>2872</b>
<b>LVM633R</b>	<b>QS</b>	66" X 24" X 30"	Cubic Ft: 32.8	Ship Weight: 229	<b>2541</b>	<b>2579</b>	<b>2617</b>
<b>LVM633RDX</b>	<b>QS</b>	66" X 24" X 30"	Cubic Ft: 32.8	Ship Weight: 229	<b>2663</b>	<b>2703</b>	<b>2743</b>
<b>LPM633R</b>		66" X 24" X 30"	Cubic Ft: 32.8	Ship Weight: 229	<b>2541</b>	<b>2579</b>	<b>2617</b>
<b>LPM633RDX</b>		66" X 24" X 30"	Cubic Ft: 32.8	Ship Weight: 229	<b>2663</b>	<b>2703</b>	<b>2743</b>

Freight Class: 125

**Left Pedestal Credenza**



- One box drawer
- One file drawer, letter or legal filing
- One pull-out writing slide
- Individually locking pedestal
- Open storage with adjustable shelf
- One grommet in open storage and one in modesty panel
- LPM - HPL top
- LVM - Wood veneer top
- DX - Picture frame molding

<b>LVM725L</b>	<b>QS</b>	72" X 24" X 30"	Cubic Ft: 35.7	Ship Weight: 230	<b>2594</b>	<b>2633</b>	<b>2672</b>	
					<b>Keyboard Platform K</b>	223	226	230
<b>LVM725LDX</b>	<b>QS</b>	72" X 24" X 30"	Cubic Ft: 35.7	Ship Weight: 230	<b>2716</b>	<b>2757</b>	<b>2797</b>	
					<b>Keyboard Platform K</b>	223	226	230
<b>LPM725L</b>		72" X 24" X 30"	Cubic Ft: 35.7	Ship Weight: 230	<b>2594</b>	<b>2633</b>	<b>2672</b>	
					<b>Keyboard Platform K</b>	223	226	230
<b>LPM725LDX</b>		72" X 24" X 30"	Cubic Ft: 35.7	Ship Weight: 230	<b>2716</b>	<b>2757</b>	<b>2797</b>	
					<b>Keyboard Platform K</b>	223	226	230
<b>LVM625L</b>	<b>QS</b>	66" X 24" X 30"	Cubic Ft: 32.8	Ship Weight: 220	<b>2292</b>	<b>2326</b>	<b>2361</b>	
					<b>Keyboard Platform K</b>	223	226	230
<b>LVM625LDX</b>	<b>QS</b>	66" X 24" X 30"	Cubic Ft: 32.8	Ship Weight: 220	<b>2415</b>	<b>2451</b>	<b>2487</b>	
					<b>Keyboard Platform K</b>	223	226	230
<b>LPM625L</b>		66" X 24" X 30"	Cubic Ft: 32.8	Ship Weight: 220	<b>2292</b>	<b>2326</b>	<b>2361</b>	
					<b>Keyboard Platform K</b>	223	226	230
<b>LPM625LDX</b>		66" X 24" X 30"	Cubic Ft: 32.8	Ship Weight: 220	<b>2415</b>	<b>2451</b>	<b>2487</b>	
					<b>Keyboard Platform K</b>	223	226	230

Freight Class: 125

**Right Pedestal Credenza**

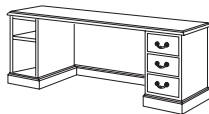

- One box drawer
- One file drawer, letter or legal filing
- One pull-out writing slide
- Individually locking pedestal
- Open storage with adjustable shelf
- One grommet in open storage and one in modesty panel
- LPM - HPL top
- LVM - Wood veneer top
- DX - Picture frame molding

<b>LVM725R</b>	<b>QS</b>	72" X 24" X 30"	Cubic Ft: 35.7	Ship Weight: 230	<b>2594</b>	<b>2633</b>	<b>2672</b>	
					<b>Keyboard Platform K</b>	223	226	230
<b>LVM725RDX</b>	<b>QS</b>	72" X 24" X 30"	Cubic Ft: 35.7	Ship Weight: 230	<b>2716</b>	<b>2757</b>	<b>2797</b>	
					<b>Keyboard Platform K</b>	223	226	230
<b>LPM725R</b>		72" X 24" X 30"	Cubic Ft: 35.7	Ship Weight: 230	<b>2594</b>	<b>2633</b>	<b>2672</b>	
					<b>Keyboard Platform K</b>	223	226	230
<b>LPM725RDX</b>		72" X 24" X 30"	Cubic Ft: 35.7	Ship Weight: 230	<b>2716</b>	<b>2757</b>	<b>2797</b>	
					<b>Keyboard Platform K</b>	223	226	230
<b>LVM625R</b>	<b>QS</b>	66" X 24" X 30"	Cubic Ft: 32.8	Ship Weight: 220	<b>2292</b>	<b>2326</b>	<b>2361</b>	
					<b>Keyboard Platform K</b>	223	226	230
<b>LVM625RDX</b>	<b>QS</b>	66" X 24" X 30"	Cubic Ft: 32.8	Ship Weight: 220	<b>2415</b>	<b>2451</b>	<b>2487</b>	
					<b>Keyboard Platform K</b>	223	226	230
<b>LPM625R</b>		66" X 24" X 30"	Cubic Ft: 32.8	Ship Weight: 220	<b>2292</b>	<b>2326</b>	<b>2361</b>	
					<b>Keyboard Platform K</b>	223	226	230
<b>LPM625RDX</b>		66" X 24" X 30"	Cubic Ft: 32.8	Ship Weight: 220	<b>2415</b>	<b>2451</b>	<b>2487</b>	
					<b>Keyboard Platform K</b>	223	226	230

Freight Class: 125



### Left Pedestal Credenza with Door

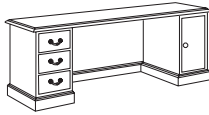

- One box drawer
- One file drawer, letter or legal filing
- One pull-out writing slide
- Individually locking pedestal
- Storage with adjustable shelf behind door
- Wire management grommets in open storage and modesty panel
- LPM - HPL top
- LVM - Wood veneer top
- DX - Picture frame molding

Freight Class: 125

### Right Pedestal Credenza with Door

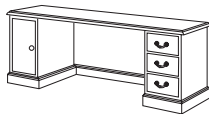

- Same as above

Zone Pricing

1

2

3

Model	Dimensions	Cubic Ft.	Ship Weight	Zone 1	Zone 2	Zone 3
LVM726L	72" x 24" x 30"	35.7	235	<b>2738</b>	<b>2779</b>	<b>2820</b>
				Keyboard Platform K	223	226
LVM726LDX	72" x 24" x 30"	35.7	235	<b>2860</b>	<b>2903</b>	<b>2946</b>
				Keyboard Platform K	223	226
LPM726L	72" x 24" x 30"	35.7	235	<b>2738</b>	<b>2779</b>	<b>2820</b>
				Keyboard Platform K	223	226
LPM726LDX	72" x 24" x 30"	35.7	235	<b>2860</b>	<b>2903</b>	<b>2946</b>
				Keyboard Platform K	223	226
LVM626L	66" x 24" x 30"	32.8	225	<b>2435</b>	<b>2472</b>	<b>2508</b>
				Keyboard Platform K	223	226
LVM626LDX	66" x 24" x 30"	32.8	225	<b>2558</b>	<b>2596</b>	<b>2635</b>
				Keyboard Platform K	223	226
LPM626L	66" x 24" x 30"	32.8	225	<b>2435</b>	<b>2472</b>	<b>2508</b>
				Keyboard Platform K	223	226
LPM626LDX	66" x 24" x 30"	32.8	225	<b>2558</b>	<b>2596</b>	<b>2635</b>
				Keyboard Platform K	223	226
LVM726R	72" x 24" x 30"	35.7	235	<b>2738</b>	<b>2779</b>	<b>2820</b>
				Keyboard Platform K	223	226
LVM726RDX	72" x 24" x 30"	35.7	235	<b>2860</b>	<b>2903</b>	<b>2946</b>
				Keyboard Platform K	223	226
LPM726R	72" x 24" x 30"	35.7	235	<b>2738</b>	<b>2779</b>	<b>2820</b>
				Keyboard Platform K	223	226
LPM726RDX	72" x 24" x 30"	35.7	235	<b>2860</b>	<b>2903</b>	<b>2946</b>
				Keyboard Platform K	223	226
LVM626R	66" x 24" x 30"	32.8	225	<b>2435</b>	<b>2472</b>	<b>2508</b>
				Keyboard Platform K	223	226
LVM626RDX	66" x 24" x 30"	32.8	225	<b>2558</b>	<b>2596</b>	<b>2635</b>
				Keyboard Platform K	223	226
LPM626R	66" x 24" x 30"	32.8	225	<b>2435</b>	<b>2472</b>	<b>2508</b>
				Keyboard Platform K	223	226
LPM626RDX	66" x 24" x 30"	32.8	225	<b>2558</b>	<b>2596</b>	<b>2635</b>
				Keyboard Platform K	223	226

### Returns, Bridges & Screens

#### Left Desk Height Return



- One box drawer
- One file drawer, letter or legal filing
- One pull-out writing slide
- Locking pedestal
- Top has reversed coped edge detail to ensure a smooth work surface
- Top features common grain direction with desk
- LPM - HPL top
- LVM - Wood veneer top
- DX - Picture frame molding

Freight Class: 110

Model	Dimensions	Cubic Ft.	Ship Weight	Zone 1	Zone 2	Zone 3
LVM722L <b>QS</b>	48" X 24" X 30"	25.3	145	<b>1876</b>	<b>1904</b>	<b>1932</b>
				Keyboard Platform K	223	226
LVM722LDX <b>QS</b>	48" X 24" X 30"	25.3	145	<b>1969</b>	<b>1999</b>	<b>2028</b>
				Keyboard Platform K	223	226
LPM722L	48" X 24" X 30"	25.3	145	<b>1876</b>	<b>1904</b>	<b>1932</b>
				Keyboard Platform K	223	226
LPM722LDX	48" X 24" X 30"	25.3	145	<b>1969</b>	<b>1999</b>	<b>2028</b>
				Keyboard Platform K	223	226
LVM622L <b>QS</b>	42" X 24" X 30"	21.8	135	<b>1714</b>	<b>1740</b>	<b>1765</b>
LVM622LDX <b>QS</b>	42" X 24" X 30"	21.8	135	<b>1806</b>	<b>1833</b>	<b>1860</b>
LPM622L	42" X 24" X 30"	21.8	135	<b>1714</b>	<b>1740</b>	<b>1765</b>
LPM622LDX	42" X 24" X 30"	21.8	135	<b>1806</b>	<b>1833</b>	<b>1860</b>



**Right Desk Height Return**



- One box drawer
- One file drawer, letter or legal filing
- One pull-out writing slide
- Locking pedestal
- Top has reversed coped edge detail to ensure a smooth work surface
- Top features common grain direction with desk
- LPM - HPL top
- LVM - Wood veneer top
- DX - Picture frame molding

Freight Class: 110

		Zone Pricing		1	2	3
<b>LVM722R</b>	<b>QS</b>	48" X 24" X 30"	Cubic Ft: 25.3 Ship Weight: 145	<b>1876</b>	<b>1904</b>	<b>1932</b>
		<b>Keyboard Platform K</b>		223	226	230
<b>LVM722RDX</b>	<b>QS</b>	48" X 24" X 30"	Cubic Ft: 25.3 Ship Weight: 145	<b>1969</b>	<b>1999</b>	<b>2028</b>
		<b>Keyboard Platform K</b>		223	226	230
<b>LPM722R</b>		48" X 24" X 30"	Cubic Ft: 25.3 Ship Weight: 145	<b>1876</b>	<b>1904</b>	<b>1932</b>
		<b>Keyboard Platform K</b>		223	226	230
<b>LPM722RDX</b>		48" X 24" X 30"	Cubic Ft: 25.3 Ship Weight: 145	<b>1969</b>	<b>1999</b>	<b>2028</b>
		<b>Keyboard Platform K</b>		223	226	230
<b>LVM622R</b>	<b>QS</b>	42" X 24" X 30"	Cubic Ft: 21.8 Ship Weight: 135	<b>1714</b>	<b>1740</b>	<b>1765</b>
<b>LVM622RDX</b>	<b>QS</b>	42" X 24" X 30"	Cubic Ft: 21.8 Ship Weight: 135	<b>1806</b>	<b>1833</b>	<b>1860</b>
<b>LPM622R</b>		42" X 24" X 30"	Cubic Ft: 21.8 Ship Weight: 135	<b>1714</b>	<b>1740</b>	<b>1765</b>
<b>LPM622RDX</b>		42" X 24" X 30"	Cubic Ft: 21.8 Ship Weight: 135	<b>1806</b>	<b>1833</b>	<b>1860</b>

**Desk Height Bridge**



- Use with single pedestal desks and credenzas
- Top has a reverse coped edge detail to ensure a solid, smooth work surface
- Top features common grain direction with desk and credenza
- LPM - HPL top
- LVM - Wood veneer top

Freight Class: 100

<b>LVM485</b>	<b>QS</b>	48" X 24" X 30"	Cubic Ft: 4 Ship Weight: 68	<b>844</b>	<b>857</b>	<b>869</b>
<b>LPM485</b>	<b>QS</b>	48" X 24" X 30"	Cubic Ft: 4 Ship Weight: 68	<b>844</b>	<b>857</b>	<b>869</b>
<b>LVM484</b>		42" X 24" X 30"	Cubic Ft: 4 Ship Weight: 60	<b>742</b>	<b>753</b>	<b>764</b>
<b>LPM484</b>		42" X 24" X 30"	Cubic Ft: 4 Ship Weight: 60	<b>742</b>	<b>753</b>	<b>764</b>

**Reception Screen for Main**

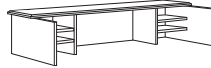

- Fits 72" x 36" single pedestal or double pedestal desks
- Non-skid rubber strips on bottom prohibits movement
- Four adjustable shelves

Freight Class: 70

<b>LVM710</b>	<b>QS</b>	72" X 35" X 14"	Cubic Ft: 31.9 Ship Weight: 140	<b>1928</b>	<b>1957</b>	<b>1986</b>
---------------	-----------	-----------------	---------------------------------	-------------	-------------	-------------

**Reception Screen for Return**

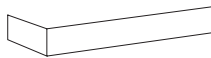

- Fits 48" x 24" executive height return
- Hardware included to join to main reception screen
- 711L fits left return
- 711R fits right return
- Assembly required

Freight Class: 100

<b>LVM711L</b>	<b>QS</b>	47" X 22" X 13"	Cubic Ft: 1.5 Ship Weight: 27	<b>474</b>	<b>481</b>	<b>488</b>
<b>LVM711R</b>	<b>QS</b>	47" X 22" X 13"	Cubic Ft: 1.5 Ship Weight: 27	<b>474</b>	<b>481</b>	<b>488</b>

**Files, Bookcases, Overhead Storage & Tables**

**Executive Lateral File**



- Two lateral file drawers, letter or legal filing
- Pre-installed PROfile filing hardware
- Front locking
- Anti-tilt mechanism to prevent tipping
- LPM - HPL top
- LVM - Wood veneer top
- DX - Picture frame molding

Freight Class: 100

<b>LVM346</b>	<b>QS</b>	38.25" X 24" X 30"	Cubic Ft: 19.5 Ship Weight: 154	<b>2001</b>	<b>2031</b>	<b>2061</b>
<b>LVM346DX</b>	<b>QS</b>	38.25" X 24" X 30"	Cubic Ft: 19.5 Ship Weight: 154	<b>2091</b>	<b>2122</b>	<b>2154</b>
<b>LPM346</b>		38.25" X 24" X 30"	Cubic Ft: 19.5 Ship Weight: 154	<b>2001</b>	<b>2031</b>	<b>2061</b>
<b>LPM346DX</b>		38.25" X 24" X 30"	Cubic Ft: 19.5 Ship Weight: 154	<b>2091</b>	<b>2122</b>	<b>2154</b>



Zone  
Pricing

1

2

3

### Four Drawer Lateral File

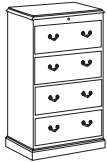

- Four lateral file drawers
- Letter or legal filing
- Pre-installed PROFile filing hardware
- Front locking
- Anti-tilt mechanism to prevent tipping
- LPM - HPL top
- LVM - Wood veneer top

Freight Class: 125

LVM426	QS	38" X 24" X 54"	Cubic Ft: 35.5	Ship Weight: 258	2805	2847	2889
LPM426		38" X 24" X 54"	Cubic Ft: 35.5	Ship Weight: 258	2805	2847	2889

### Overhead Storage Hutch



- Two storage compartments with doors and adjustable shelves
- Six adjustable shelves (4 small, 2 large)
- One wire management grommet
- 727 fits 72" credenzas
- 627 fits 66" credenzas
- LPM - HPL top
- LVM - Wood veneer top

Freight Class: 125

LVM727	QS	72" X 17" X 46"	Cubic Ft: 43.6	Ship Weight: 219	2478	2515	2552
LVM627	QS	66" X 17" X 46"	Cubic Ft: 37.1	Ship Weight: 200	2180	2213	2245

### 30" High Bookcase



- One adjustable shelf
- 1" thick shelf
- Traditional edge profile at top
- Traditional base molding
- Finished back panel

Freight Class: 125

LVM30B	QS	36.75" X 15.75" X 30"	Cubic Ft: 15	Ship Weight: 68	1061	1077	1093
--------	----	-----------------------	--------------	-----------------	------	------	------

### 48" High Bookcase



- Two adjustable shelves
- 1" thick shelves
- Traditional edge profile at top
- Traditional base molding
- Finished back panel

Freight Class: 125

LVM48B	QS	36.75" X 15.75" X 48"	Cubic Ft: 23.2	Ship Weight: 108	1227	1245	1264
--------	----	-----------------------	----------------	------------------	------	------	------

### 76" High Bookcase



- Four adjustable shelves
- 1" thick shelves
- Traditional edge profile at top
- Traditional base molding
- Finished back panel

Freight Class: 125

LVM76B	QS	36.75" X 15.75" X 76"	Cubic Ft: 31.9	Ship Weight: 172	1916	1945	1973
--------	----	-----------------------	----------------	------------------	------	------	------

### 76" High Bookcase with 2 Doors



- Same features as above except:
- Three adjustable shelves
- 2 fixed shelves
- 2 door storage area

Freight Class: 125

LVM76B2D	QS	36.75" X 15.75" X 76"	Cubic Ft: 31.9	Ship Weight: 182	2096	2127	2159
----------	----	-----------------------	----------------	------------------	------	------	------

TRADITIONAL VENEER

**Traditional Round 4-Footed Pedestal**



- 1-3/16" thick top, wood edge
- Queen Anne style pedestal base with fluted legs, brass leg caps
- Ships in two cartons, assembly required
- LVMTR48 - 45" worksurface, veneer top
- LPMTR48 - 46.25" worksurface, HPL top
- LPMTR42 - 40.25" worksurface, HPL top
- LPMTR36 - 34.25" worksurface, HPL top

Freight Class:

				Zone Pricing	1	2	3
<b>LVMTR48</b>	<b>QS</b>	48" X 30"	Cubic Ft: 20.0	Ship Weight: 105	<b>1709</b>	<b>1735</b>	<b>1760</b>
<b>LPMTR48</b>		48" X 30"	Cubic Ft: 20.0	Ship Weight: 105	<b>1709</b>	<b>1735</b>	<b>1760</b>
<b>LPMTR42</b>		42" X 30"	Cubic Ft: 18.8	Ship Weight: 97	<b>1554</b>	<b>1577</b>	<b>1601</b>
<b>LPMTR36</b>		36" X 30"	Cubic Ft: 18.6	Ship Weight: 73	<b>1205</b>	<b>1223</b>	<b>1241</b>

**Rectangular Conference Table**

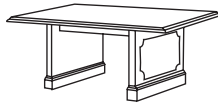

- Straight legs with traditional style base molding
- Ships in one carton, assembly required
- LPM - HPL top
- LVM - Wood veneer top
- DX - Deluxe picture frame molding

Freight Class: 92.5

<b>LVMT72</b>		72" X 36" X 30"	Cubic Ft: 14.3	Ship Weight: 165	<b>2454</b>	<b>2491</b>	<b>2528</b>
<b>LVMT72DX</b>	<b>QS</b>	72" X 36" X 30"	Cubic Ft: 14.3	Ship Weight: 165	<b>2547</b>	<b>2585</b>	<b>2623</b>
<b>LPMT72</b>		72" X 36" X 30"	Cubic Ft: 14.3	Ship Weight: 165	<b>2454</b>	<b>2491</b>	<b>2528</b>
<b>LPMT72DX</b>		72" X 36" X 30"	Cubic Ft: 14.3	Ship Weight: 165	<b>2547</b>	<b>2585</b>	<b>2623</b>

Shown with (DX) deluxe, picture-frame molding

**Center Drawers & Keyboard Platforms**

**Keyboard Platform**

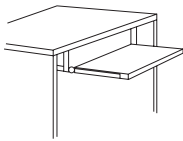

- Platform only
- LVMK35 requires 33" kneespace and fits 66" or 72" double pedestal desks or bridges only
- LVMK21 requires a 26" kneespace for installation and fits L-shaped and U-shaped workstations

Freight Class: 92.5

<b>LVMK35</b>	<b>QS</b>	29" X 18"	Cubic Ft: 3.0	Ship Weight: 17	<b>242</b>	<b>246</b>	<b>249</b>
<b>LVMK21</b>	<b>QS</b>	21" X 18"	Cubic Ft: 1.5	Ship Weight: 13	<b>223</b>	<b>226</b>	<b>230</b>

**Center Drawer**

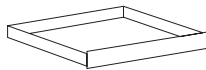

- Fits single pedestal credenzas

Freight Class: 100

<b>LVM32</b>	<b>QS</b>	32" X 18" X 3"	Cubic Ft: 2.4	Ship Weight: 13	<b>287</b>	<b>291</b>	<b>296</b>
--------------	-----------	----------------	---------------	-----------------	------------	------------	------------

TRADITIONAL VENEER



## CHARACTERISTICS

Westboro casegoods feature the beauty and variation of genuine select hardwood veneers. Unique grain pattern from piece to piece is a natural characteristic of genuine veneer and creates elegant furnishings, therefore HPFI does not guarantee matching grain pattern. All horizontal and vertical surfaces are veneer protected with durable catalyzed lacquer. Desk pads and/or glass with standoffs will further protect real wood surfaces. A semi-filled, satin style finish creates an elegant, understated presentation. All panels are 3-ply construction with medium density fiberboard (MDF) core and veneer top and bottom. Edges are CNC-shaped, then hand-finished to complement the collection.

## FINISH CHOICES

Westboro is offered in two finishes, complementing all other HPFI veneer collections.

**C** Honey Cherry

**M** Rouge Mahogany

Variation in color is an expected and natural characteristic of real wood. Minor variation in color may occur even with pieces finished at the same time. Aging and light exposure will darken wood. Therefore, HPFI does not guarantee exact color match.

## PEDESTAL CHOICES

Choose any pedestal to customize drawer configurations to individual preference. All choices are the same price.

**3** Box/Box/File

**5** File/File

**7** Left Box/Box/File & Right File/File

**9** Left File/File & Right Box/Box/File

## PULLS: STANDARD

Westboro features an ergonomically shaped, transitional pull with smooth, nickel finish. A coordinating elliptical knob is included on overheads with all-wood doors.

## SPECIFICATIONS *Case & Top*

### Tops

- 1" thick, 3-ply balanced panel construction
- Common grain direction between desk/return/bridge credenza
- Reverse-coped edges on bridge and returns for smooth worksurface connections

### Edges

- Shaped MDF with reverse-step edge profile

### Modesty Panel

- Curved at bottom
- Slight inset; attached with black metal L brackets/screws
- 3/4" thick with veneer face and back

### Pedestals

- Decorative base trim made of 1 1/8" thick

- solid hardwood and field replaceable
- Preinstalled leveling glides

### Construction

- Dowels/glue, wood cleats, metal brackets/screws and mechanical fasteners

### Assembly

- Fully assembled (except bridge, table and TriCabinet)

## SPECIFICATIONS *Drawers*

**Drawers** 5-sided construction with replaceable fronts

**Fronts** 3/4" thick core with veneer surfaces

**Box** 7/16" thick hardwood veneer interiors

**Bottom** 1/8" thick plywood

## SUSPENSIONS

**Box Drawer** 3/4-extension, steel ball-bearing

**File Drawer** Full-extension, steel ball-bearing

**Lateral File** Full-extension, steel ball-bearing

## FILING

Steel and black molded polymer hardware included

**File Drawer** Legal (side-to-side) & Letter (front-to-back and side-to-side)

**Lateral File** Legal (side-to-side) & Letter (front-to-back and side-to-side)

**Capacity** Lateral file is built for filing, maximum 40 lb bottom load

## WIRE MANAGEMENT

See features for number of grommets and location. Additional grommets can be added for extended wire management capability at \$106 list per grommet. Includes factory cut and installed grommet and black sleeve. Call for special quote. Specify location and quote number with order.

## LOCKING OPTIONAL

Locking is optional on all pedestals at \$95 list per pedestal. Specify 'Y' at the end of the model number.

- Locks are added to top right corner of top drawer of pedestal
- All locks keyed identical unless otherwise specified
- 'Key Different' option is \$21 list upcharge per lock. Locks/cores packaged to customer specifications
- Additional lead time for 'Key Different'

## Pricing Examples: Locking Upcharges

- Desk with (2) Box/Box/File Pedestals  
*Add \$190 list*
- Two-Drawer Lateral File  
*Add \$95 list*
- Return with (1) File/File Pedestal  
*Add \$95 list*
- Credenza with (2) File/File Pedestals  
*Add \$190 list*

For optional locking on overhead storage units with four wood doors with no inserts, add **Y** to the end of the model number and add \$150 to the list price.

## ACCESSORIES *Factory-Installed*

Certain accessories can be ordered factory-installed prior to shipment.

Specify appropriate designator at very end of model number and add correct list upcharge.

**C** Center Drawer

**K** Keyboard Platform

**T** Task Light

## QUICKSHIP

Quick Ship is not available on any items ordered with option.

## PACKAGING

All units are properly packed in heavy-duty cartons with reinforced corner pads. All packaging conforms to, or exceeds, specifications as outlined in the Uniform Freight Classification.

## PALLETIZATION

See page 3.

## CARE AND CLEANING INSTRUCTIONS FOR VENEER PRODUCTS

**Normal cleaning:** Wood veneer products require special care. When cleaning, it is important to use a quality window cleaner which contains no ammonia followed by a dry soft cloth to remove any dampness.

**Polish Suggestions:** To polish veneer furniture, we recommend that you use a quality furniture polish which contains no silicone followed by a dry soft cloth. Using a polish without silicone, will protect the everlasting beauty of this natural wood product.

**Warning** – Using a polish containing silicone may cloud the finish, soften, crack or lift the finish and void your warranty.

**Specifications subject to change without notice.**

**Configurations**

Zone Pricing	1	2	3
--------------	---	---	---

**Executive Office**

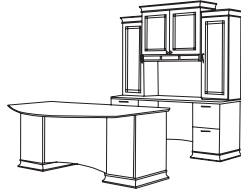

Description	Model Number	Qty	Fr. Class	Cubic Ft.	Ship Weight			
Bow Front Double Pedestal Desk	WV700B 72" x 34" x 31"	1	200	58.3	270	<b>3264</b>	<b>3313</b>	<b>3362</b>
Double Pedestal Credenza	WV725 72" x 24" x 31"	1	110	39.1	235	<b>2818</b>	<b>2860</b>	<b>2903</b>
TriCabinet Overhead with Back Panel	WV758 72" x 17.5" x 54.25"	1	125	38.0	281	<b>2705</b>	<b>2746</b>	<b>2786</b>
Total:						<b>8787</b>	<b>8919</b>	<b>9051</b>

**Executive U with Overhead**

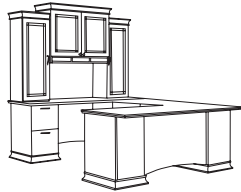

72" x 96" x 85.25"

Description	Model Number	Qty	Fr. Class	Cubic Ft.	Ship Weight			
Right Pedestal Desk	WV700R 72" x 30" x 31"	1	200	48.3	240	<b>2552</b>	<b>2590</b>	<b>2629</b>
Bridge	WV484 42" x 24" x 31"	1	100	4.9	63	<b>688</b>	<b>698</b>	<b>709</b>
Left Pedestal Credenza	WV725L 72" x 24" x 31"	1	125	39.1	213	<b>2016</b>	<b>2046</b>	<b>2076</b>
TriCabinet Overhead with Open Back	WV757 72" x 17.5" x 54.25"	1	125	38.0	271	<b>2585</b>	<b>2624</b>	<b>2663</b>
Total:						<b>7841</b>	<b>7958</b>	<b>8077</b>

**Executive L**

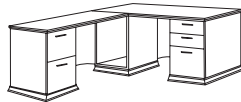

72" x 72" x 31"

Description	Model Number	Qty	Fr. Class	Cubic Ft.	Ship Weight			
Right Pedestal Desk	WV700R 72" x 30" x 31"	1	200	48.3	240	<b>2552</b>	<b>2590</b>	<b>2629</b>
Left Return	WV622L 42" x 24" x 31"	1	200	23.5	126	<b>1685</b>	<b>1710</b>	<b>1736</b>
Total:						<b>4237</b>	<b>4300</b>	<b>4365</b>

**Desks**

**Bow Front Double Pedestal Desk**

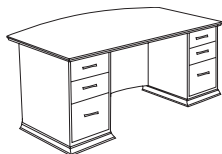

Pedestal Option Shown: 3

Freight Class: 200

- Bow front top
- 11.5" conference overhang
- Curved modesty panel
- Legal or letter filing

<b>WV700B</b> _ _ 72" X 34" X 31" Cubic Ft: 58.3 Ship Weight: 270	<b>3264</b>	<b>3313</b>	<b>3362</b>
<b>Center Drawer C</b>	213	216	219
<b>Keyboard Platform K</b>	185	188	191

<b>Pedestal:</b>	Box/Box/File <b>3</b>	File/File <b>5</b>	Left B/B/F, Right F/F <b>Z</b>	Left F/F, Right B/B/F <b>9</b>
------------------	-----------------------	--------------------	--------------------------------	--------------------------------

**Locks** \$190: **Y**

**Rectangular Double Pedestal Desk**

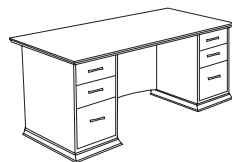

Pedestal Option Shown: 3

- Rectangular top
- 7.5" conference overhang
- Curved modesty panel
- Legal or letter filing

<b>WV700</b> _ _ 72" X 30" X 31" Cubic Ft: 48.3 Ship Weight: 262	<b>3026</b>	<b>3071</b>	<b>3117</b>
Freight Class: 200	<b>Center Drawer C</b>	213	216
	<b>Keyboard Platform K</b>	185	188

<b>WV660</b> _ _ 66" X 30" X 31" Cubic Ft: 44.5 Ship Weight: 254	<b>2949</b>	<b>2993</b>	<b>3037</b>
Freight Class: 110	<b>Center Drawer C</b>	213	216
	<b>Keyboard Platform K</b>	185	188

<b>Pedestal:</b>	Box/Box/File <b>3</b>	File/File <b>5</b>	Left B/B/F, Right F/F <b>Z</b>	Left F/F, Right B/B/F <b>9</b>
------------------	-----------------------	--------------------	--------------------------------	--------------------------------

**Locks** \$190: **Y**

TRANSITIONAL VENEER





WV700LB **C 3**  
 Finish Pedestal

### Single Pedestal Bow Front Desk

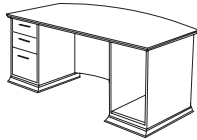

Left Pedestal Bow Front Desk

- Bow front top
- 11.5" conference overhang
- Curved modesty panel

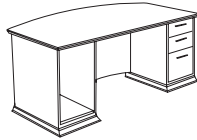

Right Pedestal Bow Front Desk

- Legal or letter filing
- Extra open storage pedestal with grommet in kneespace

### Single Pedestal Desk

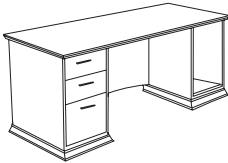

Left Pedestal Desk  
Pedestal Option Shown: 3

- Rectangular top
- 7.5" conference overhang
- Curved modesty panel

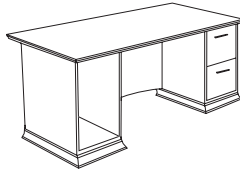

Right Pedestal Desk  
Pedestal Option Shown: 5

- Legal or letter filing
- Extra open storage pedestal with grommet in kneespace

Freight Class: 200

### Table Desk, Queen Anne Leg

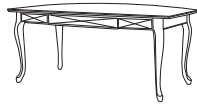

Freight Class: 125

- Queen Anne legs
- Keyboard drawer with drop-down front
- Assembly required

## Credenzas, Returns & Bridge

### Double Pedestal Credenza

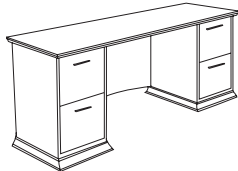

Freight Class: 110

- Curved modesty panel
- Legal or letter filing
- One grommet in modesty panel

Pedestal Option Shown: 5

### Single Pedestal Credenza

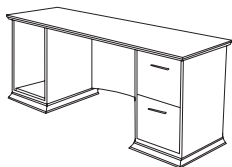

Right Pedestal Credenza  
Pedestal Option Shown: 5

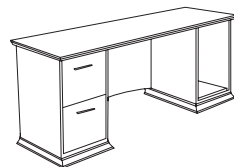

Left Pedestal Credenza

- Curved modesty panel
- Legal or letter filing
- Extra open storage pedestal with grommet in kneespace
- One grommet in modesty panel

Freight Class: 125

Zone Pricing	1	2	3
--------------	---	---	---

<b>WV700LB</b> _ 72" X 34" X 31" Cubic Ft: 58.3 Ship Weight: 249	<b>2788</b>	<b>2830</b>	<b>2872</b>
Center Drawer <b>C</b>	213	216	219
Keyboard Platform <b>K</b>	185	188	191
<b>WV700RB</b> _ 72" X 34" X 31" Cubic Ft: 58.3 Ship Weight: 249	<b>2788</b>	<b>2830</b>	<b>2872</b>
Center Drawer <b>C</b>	213	216	219
Keyboard Platform <b>K</b>	185	188	191
Pedestal Option Shown: 3			
Freight Class: 200			
<b>Pedestal:</b> Box/Box/File <b>3</b> File/File <b>5</b>			<b>Locks</b> \$95: <b>Y</b>

<b>WV700L</b> _ 72" X 30" X 31" Cubic Ft: 48.3 Ship Weight: 240	<b>2552</b>	<b>2590</b>	<b>2629</b>
Center Drawer <b>C</b>	213	216	219
Keyboard Platform <b>K</b>	185	188	191
<b>WV700R</b> _ 72" X 30" X 31" Cubic Ft: 48.3 Ship Weight: 240	<b>2552</b>	<b>2590</b>	<b>2629</b>
Center Drawer <b>C</b>	213	216	219
Keyboard Platform <b>K</b>	185	188	191
<b>WV660L</b> _ 66" X 30" X 31" Cubic Ft: 44.5 Ship Weight: 232	<b>2467</b>	<b>2504</b>	<b>2541</b>
Center Drawer <b>C</b>	213	216	219
Keyboard Platform <b>K</b>	185	188	191
<b>WV660R</b> _ 66" X 30" X 31" Cubic Ft: 44.5 Ship Weight: 232	<b>2467</b>	<b>2504</b>	<b>2541</b>
Center Drawer <b>C</b>	213	216	219
Keyboard Platform <b>K</b>	185	188	191
<b>Pedestal:</b> Box/Box/File <b>3</b> File/File <b>5</b>			<b>Locks</b> \$95: <b>Y</b>

<b>WV602</b> _ 66" X 30" X 30.5" Cubic Ft: 15 Ship Weight: 132	<b>1422</b>	<b>1443</b>	<b>1465</b>
<b>WV702</b> _ 72" X 30" X 30.5" Cubic Ft: 15 Ship Weight: 140	<b>1542</b>	<b>1565</b>	<b>1588</b>
<b>WV702B</b> _ 72" X 34" X 30.5" Cubic Ft: 15 Ship Weight: 148	<b>1659</b>	<b>1684</b>	<b>1709</b>

<b>WV725</b> _ 72" X 24" X 31" Cubic Ft: 39.1 Ship Weight: 235	<b>2818</b>	<b>2860</b>	<b>2903</b>
Keyboard Platform <b>K</b>	185	188	191
<b>WV625</b> _ 66" X 24" X 31" Cubic Ft: 36 Ship Weight: 227	<b>2681</b>	<b>2721</b>	<b>2761</b>
Keyboard Platform <b>K</b>	185	188	191
<b>Pedestal:</b> Box/Box/File <b>3</b> File/File <b>5</b> Left B/B/F, Right F/F <b>Z</b> Left F/F, Right B/B/F <b>9</b>			<b>Locks</b> \$190: <b>Y</b>

<b>WV725L</b> _ 72" X 24" X 31" Cubic Ft: 39.1 Ship Weight: 213	<b>2016</b>	<b>2046</b>	<b>2076</b>
Keyboard Platform <b>K</b>	185	188	191
<b>WV725R</b> _ 72" X 24" X 31" Cubic Ft: 39.1 Ship Weight: 213	<b>2016</b>	<b>2046</b>	<b>2076</b>
Keyboard Platform <b>K</b>	185	188	191
<b>WV625L</b> _ 66" X 24" X 31" Cubic Ft: 36 Ship Weight: 207	<b>1934</b>	<b>1963</b>	<b>1992</b>
Keyboard Platform <b>K</b>	185	188	191
<b>WV625R</b> _ 66" X 24" X 31" Cubic Ft: 36 Ship Weight: 207	<b>1934</b>	<b>1963</b>	<b>1992</b>
Keyboard Platform <b>K</b>	185	188	191
<b>Pedestal:</b> Box/Box/File <b>3</b> File/File <b>5</b>			<b>Locks</b> \$95: <b>Y</b>

**Lateral File Credenza**

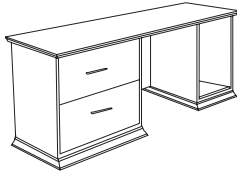

Left Lateral File Credenza

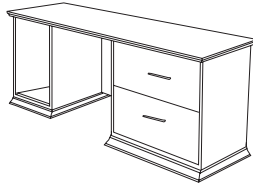

Right Lateral File Credenza

- Two lateral file drawers
- Legal or letter filing

- Extra open storage pedestal with grommet in kneespace
- Rectangular modesty panel only

Freight Class: 125

**Return**

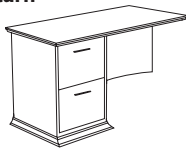

Left Return  
Pedestal Option Shown: 5

- Curved modesty panel
- Common grain direction with desks/credenzas
- Legal or letter filing

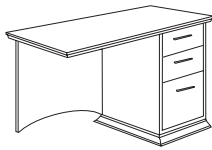

Right Return  
Pedestal Option Shown: 3

- One grommet in modesty panel
- Reversed coped edges for smooth connections

Freight Class: 200

**Bridge**



Freight Class: 100

- Curved modesty panel
- Common grain direction with desks/credenzas
- Reversed coped edges for smooth connections
- Two grommets in modesty panel

**Overhead Storage**

**TriCabinet Overhead**

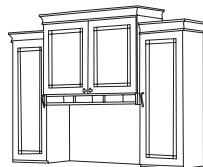
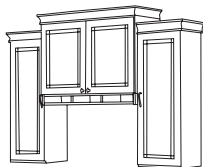

- Three storage compartments
- Four doors with etched glass inserts
- Standard with glass shelves and curio accent light

- Three paper shelves
- Ships in two cartons easy assembly required
- Optional woodshelf for center cabinet (WCSW)

**Overhead Storage with Wood Doors**

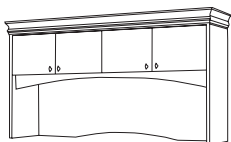

- Two storage compartments
- Four wood doors
- Integral wire management
- Flared crown decor and light rail

Freight Class: 125

Zone Pricing	1	2	3
--------------	---	---	---

<b>WV733L</b> _ 72" X 24" X 31" Cubic Ft: 39.1 Ship Weight: 260	<b>2207</b>	<b>2240</b>	<b>2273</b>
<b>WV733R</b> _ 72" X 24" X 31" Cubic Ft: 39.1 Ship Weight: 260	<b>2207</b>	<b>2240</b>	<b>2273</b>
<b>WV633L</b> _ 66" X 24" X 31" Cubic Ft: 36 Ship Weight: 252	<b>1966</b>	<b>1995</b>	<b>2025</b>
<b>WV633R</b> _ 66" X 24" X 31" Cubic Ft: 36 Ship Weight: 252	<b>1966</b>	<b>1995</b>	<b>2025</b>

**Locks** \$95: **Y**

<b>WV622L</b> _ 42" X 24" X 31" Cubic Ft: 23.5 Ship Weight: 126	<b>1685</b>	<b>1710</b>	<b>1736</b>
<b>Keyboard Platform K</b>	185	188	191
<b>WV622R</b> _ 42" X 24" X 31" Cubic Ft: 23.5 Ship Weight: 126	<b>1685</b>	<b>1710</b>	<b>1736</b>
<b>Keyboard Platform K</b>	185	188	191

**Pedestal:** Box/Box/File **3** File/File **5** **Locks** \$95: **Y**

<b>WV484</b> _ 42" X 24" X 31" Cubic Ft: 4.9 Ship Weight: 63	<b>688</b>	<b>698</b>	<b>709</b>
--	------------	------------	------------

<b>WV757</b> _ 72" X 17.5" X 54.25" Cubic Ft: 38 Ship Weight: 271	<b>2585</b>	<b>2624</b>	<b>2663</b>
Freight Class: 125 (Open Back)	<b>Task Light T</b>	124	126
	<b>LED Task Light L</b>	212	215
<b>WV758</b> _ 72" X 17.5" X 54.25" Cubic Ft: 38 Ship Weight: 281	<b>2705</b>	<b>2746</b>	<b>2786</b>
Freight Class: 125 (Back Panel)	<b>Task Light T</b>	124	126
	<b>LED Task Light L</b>	212	215

<b>WVCSW</b> _ Cubic Ft: 1 Ship Weight: 10	<b>117</b>	<b>119</b>	<b>121</b>
--	------------	------------	------------

Freight Class: 70

<b>WV729</b> _ 74" X 17.25" X 40.25" Cubic Ft: 36.5 Ship Weight: 210	<b>2016</b>	<b>2046</b>	<b>2076</b>
	<b>Task Light T</b>	124	126
	<b>LED Task Light L</b>	212	215
<b>WV629</b> _ 68" X 17.25" X 40.25" Cubic Ft: 36.5 Ship Weight: 181	<b>1934</b>	<b>1963</b>	<b>1992</b>
	<b>Task Light T</b>	124	126
	<b>LED Task Light L</b>	212	215

**Locks** \$150: **Y**

TRANSITIONAL VENEER



## File, Bookcases & Table

Zone Pricing

1

2

3

### Bookcase Hutch



- Two adjustable bookshelves
- Fits two drawer lateral file

**WV317\_** 34.75" X 17.25" X 40.25" Cubic Ft: 19.5 Ship Weight: 125 **966** **980** **995**

Freight Class: 125

### Two-Drawer Lateral File

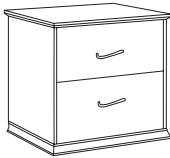

- Two lateral file drawers
- Legal or letter filing
- Filing hardware included

**WV346\_** 33" X 24" X 31" Cubic Ft: 19.6 Ship Weight: 142 **1422** **1443** **1465**

**Locks** \$95: Y

Freight Class: 125

### Five Shelf Bookcase

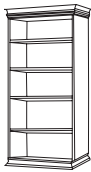

- Four adjustable bookshelves
- Bottom shelf fixed
- All shelves 1" thick

**WV79\_** 35" X 17.25" X 31" Cubic Ft: 36.9 Ship Weight: 233 **2097** **2128** **2160**

Freight Class: 125

### Round Table



- Veneer top
- Black metal base
- Ships in two cartons
- Easy to assemble

**WVR36\_** 36" X 29" Cubic Ft: 13.9 Ship Weight: 62 **605** **614** **623**

Freight Class: 400

## Center Drawers & Keyboard Platforms

### Center Drawer

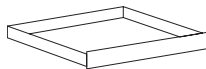

- GVCD38\_ Fits 72" double pedestal desks & credenzas
- GVCD32\_ Fits 66" double pedestal desks & credenzas
- GVCD30\_ Fits 72" single pedestal desks & credenzas
- GVCD25\_ Fits 66" single pedestal desks & credenzas

<b>GVCD38_</b>	38" X 18" X 3"	Cubic Ft: 2.4	Ship Weight: 13.5	<b>213</b>	<b>216</b>	<b>219</b>
<b>GVCD32_</b>	32" X 18" X 3"	Cubic Ft: 2.4	Ship Weight: 13	<b>213</b>	<b>216</b>	<b>219</b>
<b>GVCD30_</b>	30.5" X 18" X 3"	Cubic Ft: 2.4	Ship Weight: 13	<b>213</b>	<b>216</b>	<b>219</b>
<b>GVCD25_</b>	24.5" X 18" X 3"	Cubic Ft: 2.4	Ship Weight: 12	<b>213</b>	<b>216</b>	<b>219</b>

Freight Class: 100

### Keyboard Platform

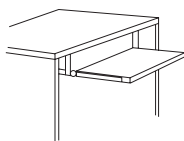

- Platform only
- GVK21 Fits single pedestal desks, credenzas and returns
- GVK29 Fits double pedestal desks and credenzas

<b>GVK21_</b>	22" X 18" X 2.75"	Cubic Ft: 1.3	Ship Weight: 13	<b>185</b>	<b>188</b>	<b>191</b>
<b>GVK29_</b>	28" X 18" X 2.75"	Cubic Ft: 1.3	Ship Weight: 18	<b>185</b>	<b>188</b>	<b>191</b>

Freight Class: 92.5

**CHARACTERISTICS**

Inverness casegoods feature the beauty and variation of genuine select hardwood veneers. Unique grain pattern from piece to piece is a natural characteristic of genuine veneer and creates elegant furnishings, therefore HPFI does not guarantee matching grain pattern. All horizontal and vertical surfaces are veneer protected with durable catalyzed lacquer. Desk pads and/or glass with standoffs will further protect real wood surfaces. A semi-filled, satin style finish creates an elegant, understated presentation. All panels are 3-ply construction with medium density fiberboard (MDF) core and veneer top and bottom. Edges are CNC-shaped, then hand-finished to complement the collection.

**FINISH CHOICES**

Inverness is offered in two finishes, complementing all other HPFI veneer collections.

**C** Honey Cherry

**M** Rouge Mahogany

Variation in color is an expected and natural characteristic of real wood. Minor variation in color may occur even with pieces finished at the same time. Aging and light exposure will darken wood. Therefore, HPFI does not guarantee exact color match.

**PEDESTAL CHOICES**

Choose any pedestal to customize drawer configurations to individual preference. All choices are the same price.

**3** Box/Box/File

**5** File/File

**7** Left Box/Box/File & Right File/File

**9** Left File/File & Right Box/Box/File

**PULLS: STANDARD**

Inverness features traditional design pulls with antique brass style finish. A coordinating round knob is included on overheads with solid wood doors.

**PULLS: ALTERNATIVE**

As an alternative, solid metal, curvilinear pulls are available in three colors at the same price. Specify pull designator after the drawer configuration in the model number.

**W** Brushed Chrome

**E** Ebony (black)

**B** Bright Brass

**SPECIFICATIONS Case & Top****Tops**

- 1" thick, 3-ply balanced panel construction
- Common grain direction between desk/return/bridge credenza
- Reverse-coped edges on bridge and returns for smooth worksurface connections

**Edges**

- Shaped MDF with reverse-step edge profile

**Modesty Panel**

- Rectangular
- Slight inset; attached with black metal L brackets/screws
- ¾" thick with veneer face and back

**Pedestals**

- Picture-frame molding standard on pedestals, ends and approach sides.
- Decorative base trim made of 1½" thick solid hardwood and field replaceable
- Preinstalled leveling glides

**Construction**

- Dowels/glue, wood cleats, metal brackets/screws and mechanical fasteners

**Assembly**

- Fully assembled (except bridge and table)

**SPECIFICATIONS Drawers**

**Drawers** 5-sided construction with replaceable fronts

**Fronts** ¾" thick core with veneer surfaces

**Box** 7/16" thick hardwood veneer

**Bottom** ½" thick plywood

**SUSPENSIONS**

**Box Drawer** ¾ extension, steel ball-bearing

**File Drawer** Full-extension, steel ball-bearing

**Lateral File** Full-extension, steel ball-bearing

**FILING**

Steel molded polymer hardware included

**File Drawer** Legal (side-to-side) & Letter (front-to-back and side-to-side)

**Lateral File** Legal (side-to-side) & Letter (front-to-back and side-to-side)

**Capacity** Lateral file is built for filing. Maximum 40 lb

**WIRE MANAGEMENT**

See features for number of grommets and location. Additional grommets can be added for extended wire management capability at \$106 list per grommet. Includes factory cut and installed grommet and black sleeve. Call for special quote. Specify location and quote number with order.

**LOCKING OPTIONAL**

Locking is optional on all pedestals at \$95 list per pedestal. Specify 'Y' at the end of the model number.

- Locks are added to top right corner of top drawer of pedestal
- All locks keyed identical unless otherwise specified
- 'Key Different' option is \$21 list upcharge per lock. Locks/cores packaged to customer specifications.
- Additional lead time for 'Key Different'

**Pricing Examples: Locking Upcharges**

- Desk with (2) Box/Box/File Pedestals  
Add \$190 list
- Two-Drawer Lateral File  
Add \$95 list
- Return with (1) File/File Pedestal  
Add \$95 list
- Credenza with (2) File/File Pedestals  
Add \$190 list

For optional locking on overhead storage units with four wood doors with no inserts, add Y to the end of the model number and add \$150 to the list price.

**ACCESSORIES Factory-Installed**

Certain accessories can be ordered factory-installed prior to shipment. Specify appropriate designator at very end of model number and add correct list upcharge.

**C** Center Drawer

**K** Keyboard Platform

**T** Task Light

**QUICKSHIP**

Quick Ship is not available on any items ordered with option.

**PACKAGING**

All units are properly packed in heavy-duty cartons with reinforced corner pads. All packaging conforms to, or exceeds, specifications as outlined in the Uniform Freight Classification.

**PALLETIZATION**

See page 3.

**CARE AND CLEANING INSTRUCTIONS FOR VENEER PRODUCTS**

**Normal cleaning:** Wood veneer products require special care. When cleaning, it is important to use a quality window cleaner which contains no ammonia followed by a dry soft cloth to remove any dampness.

**Polish Suggestions:** To polish veneer furniture, we recommend that you use a quality furniture polish which contains no silicone followed by a dry soft cloth. Using a polish without silicone, will protect the everlasting beauty of this natural wood product.

**Warning** – Using a polish containing silicone may cloud the finish, soften, crack or lift the finish and void your warranty.

**Specifications subject to change without notice.**



IV700R C 3  
 Finish Pedestal

## Configurations

Zone Pricing	1	2	3
--------------	---	---	---

### Executive Office

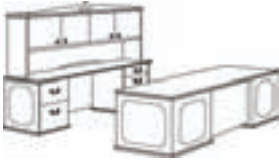

Description	Model Number	Qty	Frts. Class	Cubic Ft.	Ship Weight	1	2	3
Double Pedestal Desk	IV700_ _ 72" x 30" x 29"	1	110	43.5	258	2016	2046	2076
Double Pedestal Credenza	IV725_ _ 72" x 24" x 29"	1	110	36.1	231	1802	1829	1856
Overhead Storage with Wood Doors	IV729_ _ 72" x 16" x 41"	1	125	34.4	181	1711	1737	1762
Total:						5529	5612	5694

### Executive U with Overhead



72" x 96" x 70"

Description	Model Number	Qty	Frts. Class	Cubic Ft.	Ship Weight	1	2	3
Right Pedestal Desk	IV700R_ _ 72" x 30" x 29"	1	200	43.5	234	1863	1891	1919
Bridge	IV484_ _ 42" x 24" x 29"	1	100	4.9	63	605	614	623
Left Pedestal Credenza	IV725L_ _ 72" x 24" x 29"	1	125	36.1	207	1650	1675	1700
Overhead Storage with Wood Doors	IV729_ _ 72" x 16" x 41"	1	125	34.4	181	1711	1737	1762
Total:						5829	5917	6004

### Executive L

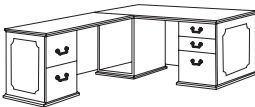

72" x 72" x 29"

Description	Model Number	Qty	Frts. Class	Cubic Ft.	Ship Weight	1	2	3
Right Pedestal Desk	IV700R_ _ 72" x 30" x 29"	1	200	43.5	234	1863	1891	1919
Left Return	IV622L_ _ 42" x 24" x 29"	1	110	21.8	124	1376	1397	1417
Total:						3239	3288	3336

## Desks

### Bow Front Double Pedestal Desk



Pedestal Option Shown: 3

Freight Class: 200

- Bow front top
- 11.5" conference overhang
- Picture frame molding
- Legal or letter filing

<b>IV700B_ _</b> 72" X 34" X 29" Cubic Ft: 51.6 Ship Weight: 267	<b>2201</b>	<b>2234</b>	<b>2267</b>
<b>Center Drawer C</b>	213	216	219
<b>Keyboard Platform K</b>	185	188	191

<b>Pedestal:</b>	Box/Box/File <b>3</b>	File/File <b>5</b>	Left B/B/F, Right F/F <b>Z</b>	Left F/F, Right B/B/F <b>9</b>
------------------	-----------------------	--------------------	--------------------------------	--------------------------------

**Locks** \$190: **Y**

### Rectangular Double Pedestal Desk

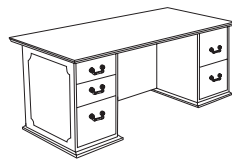

Pedestal Option Shown: 7

Freight Class: 110

- Rectangular top
- 7.5" conference overhang
- Picture frame molding
- Legal or letter filing

<b>IV700_ _</b> 72" X 30" X 29" Cubic Ft: 43.5 Ship Weight: 258	<b>2016</b>	<b>2046</b>	<b>2076</b>
<b>Center Drawer C</b>	213	216	219
<b>Keyboard Platform K</b>	185	188	191

<b>IV660_ _</b> 66" X 30" X 29" Cubic Ft: 40.2 Ship Weight: 250	<b>1955</b>	<b>1984</b>	<b>2014</b>
<b>Center Drawer C</b>	213	216	219
<b>Keyboard Platform K</b>	185	188	191

<b>Pedestal:</b>	Box/Box/File <b>3</b>	File/File <b>5</b>	Left B/B/F, Right F/F <b>Z</b>	Left F/F, Right B/B/F <b>9</b>
------------------	-----------------------	--------------------	--------------------------------	--------------------------------

**Locks** \$190: **Y**



**Bow Front Single Pedestal Desk**

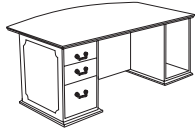

Left Pedestal Bow Front Desk

- Bow front top
- 11.5" conference overhang
- Picture frame molding

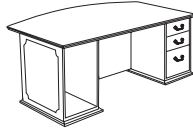

Right Pedestal Bow Front Desk

- Legal or letter filing
- Extra open storage pedestal with grommet in kneespace

**Single Pedestal Desk**



Left Pedestal Desk  
Pedestal Option Shown: 3

- Rectangular top
- 7.5" conference overhang
- Picture frame molding

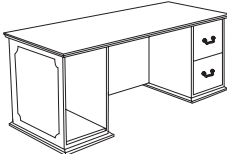

Right Pedestal Desk  
Pedestal Option Shown: 5

- Legal or letter filing
- Extra open storage pedestal with grommet in kneespace

**Table Desk, Queen Anne Leg**



- Queen Anne legs
- Keyboard drawer with drop-down front
- Assembly required

Freight Class: 125

**Credenzas, Returns & Bridge**

**Double Pedestal Credenza**

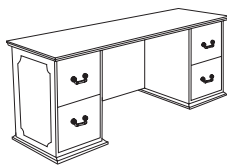

- Picture frame molding
- Legal or letter filing
- One grommet in modesty panel

Pedestal Option Shown: 5

Freight Class: 110

**Single Pedestal Credenza**

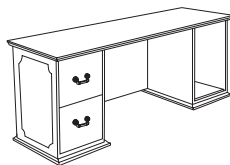

Left Pedestal Credenza

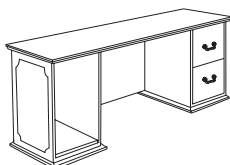

Right Pedestal Credenza  
Pedestal Option Shown: 5

- Picture frame molding
- Legal or letter filing
- Extra open storage pedestal with grommet in kneespace
- One grommet in modesty panel

Freight Class: 125

Zone Pricing	1	2	3
--------------	---	---	---

<b>IV700LB</b> _ _ 72" X 34" X 29" Cubic Ft: 51.6 Ship Weight: 243	<b>2047</b>	<b>2078</b>	<b>2108</b>
<b>Center Drawer C</b>	213	216	219
<b>Keyboard Platform K</b>	185	188	191
<b>IV700RB</b> _ _ 72" X 34" X 29" Cubic Ft: 51.6 Ship Weight: 243	<b>2047</b>	<b>2078</b>	<b>2108</b>
<b>Center Drawer C</b>	213	216	219
<b>Keyboard Platform K</b>	185	188	191
Pedestal Option Shown: 3 Freight Class: 200			
<b>Pedestal:</b> Box/Box/File <b>3</b> File/File <b>5</b>	<b>Locks</b> \$95: <b>Y</b>		

<b>IV700L</b> _ _ 72" X 30" X 29" Cubic Ft: 43.5 Ship Weight: 234	<b>1863</b>	<b>1891</b>	<b>1919</b>
<b>Center Drawer C</b>	213	216	219
<b>Keyboard Platform K</b>	185	188	191
Freight Class: 200			
<b>IV700R</b> _ _ 72" X 30" X 29" Cubic Ft: 43.5 Ship Weight: 234	<b>1863</b>	<b>1891</b>	<b>1919</b>
<b>Center Drawer C</b>	213	216	219
<b>Keyboard Platform K</b>	185	188	191
Freight Class: 200			
<b>IV660L</b> _ _ 66" X 30" X 29" Cubic Ft: 40.2 Ship Weight: 226	<b>1802</b>	<b>1829</b>	<b>1856</b>
<b>Center Drawer C</b>	213	216	219
<b>Keyboard Platform K</b>	185	188	191
Freight Class: 110			
<b>IV660R</b> _ _ 66" X 30" X 29" Cubic Ft: 40.2 Ship Weight: 226	<b>1802</b>	<b>1829</b>	<b>1856</b>
<b>Center Drawer C</b>	213	216	219
<b>Keyboard Platform K</b>	185	188	191
Freight Class: 110			
<b>Pedestal:</b> Box/Box/File <b>3</b> File/File <b>5</b>	<b>Locks</b> \$95: <b>Y</b>		

<b>IV602</b> _ _ 66" X 30" X 30.5" Cubic Ft: 15 Ship Weight: 132	<b>1422</b>	<b>1443</b>	<b>1465</b>
<b>IV702</b> _ _ 72" X 30" X 30.5" Cubic Ft: 15 Ship Weight: 140	<b>1542</b>	<b>1565</b>	<b>1588</b>
<b>IV702B</b> _ _ 72" X 34" X 30.5" Cubic Ft: 15 Ship Weight: 148	<b>1659</b>	<b>1684</b>	<b>1709</b>

<b>IV725</b> _ _ 72" X 24" X 29" Cubic Ft: 36.1 Ship Weight: 231	<b>1802</b>	<b>1829</b>	<b>1856</b>
<b>Keyboard Platform K</b>	185	188	191
<b>IV625</b> _ _ 66" X 24" X 29" Cubic Ft: 33.2 Ship Weight: 223	<b>1743</b>	<b>1769</b>	<b>1795</b>
<b>Keyboard Platform K</b>	185	188	191
<b>Pedestal:</b> Box/Box/File <b>3</b> File/File <b>5</b> Left B/B/F, Right F/F <b>7</b> Left F/F, Right B/B/F <b>9</b>	<b>Locks</b> \$190: <b>Y</b>		

<b>IV725L</b> _ _ 72" X 24" X 29" Cubic Ft: 36.1 Ship Weight: 207	<b>1650</b>	<b>1675</b>	<b>1700</b>
<b>Keyboard Platform K</b>	185	188	191
<b>IV725R</b> _ _ 72" X 24" X 29" Cubic Ft: 36.1 Ship Weight: 207	<b>1650</b>	<b>1675</b>	<b>1700</b>
<b>Keyboard Platform K</b>	185	188	191
<b>IV625L</b> _ _ 66" X 24" X 29" Cubic Ft: 33.2 Ship Weight: 201	<b>1588</b>	<b>1612</b>	<b>1636</b>
<b>Keyboard Platform K</b>	185	188	191
<b>IV625R</b> _ _ 66" X 24" X 29" Cubic Ft: 33.2 Ship Weight: 201	<b>1588</b>	<b>1612</b>	<b>1636</b>
<b>Keyboard Platform K</b>	185	188	191
<b>Pedestal:</b> Box/Box/File <b>3</b> File/File <b>5</b>	<b>Locks</b> \$95: <b>Y</b>		

# INVERNESS SIN 711-8

Edge Profile



How to Order

IV733L C  
Finish

Zone Pricing	1	2	3
--------------	---	---	---

## Lateral File Credenza

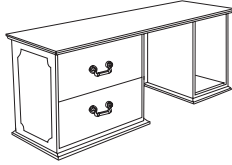

Left Lateral File Credenza

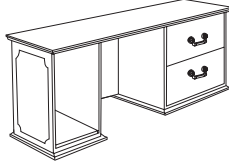

Right Lateral File Credenza

- Two lateral file drawers
- Legal or letter filing

- One open storage pedestal with grommet in kneespace
- Picture frame molding

Freight Class: 125

<b>IV733L_</b>	72" X 24" X 29"	Cubic Ft: 36.1	Ship Weight: 252	<b>1802</b>	<b>1829</b>	<b>1856</b>
<b>IV633L_</b>	66" X 24" X 29"	Cubic Ft: 33.2	Ship Weight: 244	<b>1743</b>	<b>1769</b>	<b>1795</b>
<b>IV733R_</b>	72" X 24" X 29"	Cubic Ft: 36.1	Ship Weight: 252	<b>1802</b>	<b>1829</b>	<b>1856</b>
<b>IV633R_</b>	66" X 24" X 29"	Cubic Ft: 33.2	Ship Weight: 244	<b>1743</b>	<b>1769</b>	<b>1795</b>

Locks \$95: Y

## Return

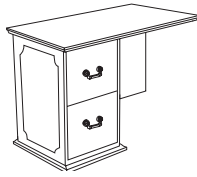

Left Return  
Pedestal Option Shown: 5

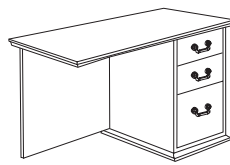

Right Return  
Pedestal Option Shown: 3

- Picture frame molding
- Common grain direction with desks/credenzas
- Legal or letter filing

- One grommet in modesty panel
- Reversed coped edges for smooth connections

Freight Class: 110

<b>IV622L_</b>	42" X 24" X 29"	Cubic Ft: 21.8	Ship Weight: 124	<b>1376</b>	<b>1397</b>	<b>1417</b>
			<b>Keyboard Platform K</b>	185	188	191
<b>IV622R_</b>	42" X 24" X 29"	Cubic Ft: 21.8	Ship Weight: 124	<b>1376</b>	<b>1397</b>	<b>1417</b>
			<b>Keyboard Platform K</b>	185	188	191

Pedestal: Box/Box/File **3** File/File **5**

Locks \$95: Y

## Bridge

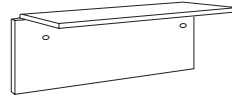

- Common grain direction with desks/credenzas
- Reversed coped edges for smooth connections
- Two grommets in modesty panel

Freight Class: 100

<b>IV484_</b>	42" X 24" X 29"	Cubic Ft: 4.9	Ship Weight: 63	<b>605</b>	<b>614</b>	<b>623</b>
---------------	-----------------	---------------	-----------------	------------	------------	------------

## Overhead Storage

### Overhead Storage with Frosted Door Insets

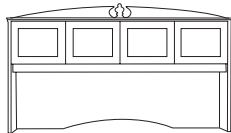

- Two storage compartments
- Four doors with frosted inserts
- Integral wire management
- Crown décor and finial are attached in the field
- Includes light rail

Freight Class: 125

<b>IV730_</b>	72" X 16" X 41"	Cubic Ft: 34.4	Ship Weight: 183	<b>1711</b>	<b>1737</b>	<b>1762</b>
			<b>Task Light T</b>	124	126	128
			<b>LED Task Light L</b>	212	215	218
<b>IV630_</b>	66" X 16" X 41"	Cubic Ft: 28.3	Ship Weight: 163	<b>1650</b>	<b>1675</b>	<b>1700</b>
			<b>Task Light T</b>	124	126	128
			<b>LED Task Light L</b>	212	215	218

### Overhead Storage with Wood Doors

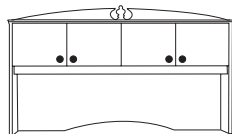

- Two storage compartments
- Four wood doors
- Integral wire management
- Crown décor and finial are attached in the field
- Includes light rail

Freight Class: 125

<b>IV729_</b>	72" X 16" X 41"	Cubic Ft: 34.4	Ship Weight: 181	<b>1711</b>	<b>1737</b>	<b>1762</b>
			<b>Task Light T</b>	124	126	128
			<b>LED Task Light L</b>	212	215	218
<b>IV629_</b>	66" X 16" X 41"	Cubic Ft: 28.3	Ship Weight: 161	<b>1650</b>	<b>1675</b>	<b>1700</b>
			<b>Task Light T</b>	124	126	128
			<b>LED Task Light L</b>	212	215	218

Locks \$150: Y

TRANSITIONAL VENEER

**File, Bookcase Hutch & Table**

Zone Pricing	1	2	3
--------------	---	---	---

**Two-Drawer Lateral File**

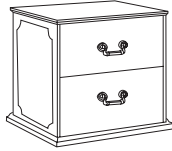

- Two lateral file drawers
- Legal or letter filing
- Picture frame molding
- Decorative base trim
- Traditional design metal pulls with antique brass finish

<b>IV346_</b>	33" X 24" X 29"	Cubic Ft: 14	Ship Weight: 134	<b>1161</b>	<b>1178</b>	<b>1196</b>
---------------	-----------------	--------------	------------------	-------------	-------------	-------------

**Locks** \$95: Y

Freight Class: 125

**Bookcase Hutch**



- Two adjustable bookshelves
- Fits on two drawer lateral file

<b>IV317_</b>	33" X 16" X 36.5"	Cubic Ft: 15.3	Ship Weight: 95	<b>824</b>	<b>836</b>	<b>849</b>
---------------	-------------------	----------------	-----------------	------------	------------	------------

Freight Class: 125

**Round Table**



- Round veneer top
- Black metal base
- Ships in two cartons
- Easy to assemble

<b>AVR36_</b>	36" X 29"	Cubic Ft: 13.9	Ship Weight: 62	<b>605</b>	<b>614</b>	<b>623</b>
---------------	-----------	----------------	-----------------	------------	------------	------------

Freight Class: 400

**Center Drawers & Keyboard Platforms**

**Center Drawer**

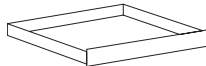

- GVCD38\_ Fits 72" double pedestal desks & credenzas
- GVCD32\_ Fits 66" double pedestal desks & credenzas
- GVCD30\_ Fits 72" single pedestal desks & credenzas
- GVCD25\_ Fits 66" single pedestal desks & credenzas

<b>GVCD38_</b>	38" X 18" X 3"	Cubic Ft: 2.4	Ship Weight: 13.5	<b>213</b>	<b>216</b>	<b>219</b>
<b>GVCD32_</b>	32" X 18" X 3"	Cubic Ft: 2.4	Ship Weight: 13	<b>213</b>	<b>216</b>	<b>219</b>
<b>GVCD30_</b>	30.5" X 18" X 3"	Cubic Ft: 2.4	Ship Weight: 13	<b>213</b>	<b>216</b>	<b>219</b>
<b>GVCD25_</b>	24.5" X 18" X 3"	Cubic Ft: 2.4	Ship Weight: 12	<b>213</b>	<b>216</b>	<b>219</b>

Freight Class: 100

**Keyboard Platform**

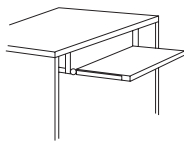

- Platform only
- GVK21 Fits single pedestal desks, credenzas and returns
- GVK29 Fits double pedestal desks and credenzas

<b>GVK21_</b>	22" X 18" X 2.75"	Cubic Ft: 1.3	Ship Weight: 13	<b>185</b>	<b>188</b>	<b>191</b>
<b>GVK29_</b>	28" X 18" X 2.75"	Cubic Ft: 1.3	Ship Weight: 18	<b>185</b>	<b>188</b>	<b>191</b>

Freight Class: 92.5

TRANSITIONAL VENEER

# LAMINATE CASEGOODS





## CHARACTERISTICS

Stratus casegoods offer choices for design flexibility, adapting to personal work requirements. The details below will help you understand the key components of Stratus®.

## FINISHES

– ALL COLORS ARE THE SAME PRICE

All finishes are thermally fused laminates unless otherwise noted.

## FINISH COLORS

<b>AP</b> Aspen	<b>WC</b> Windsor Cherry
<b>E</b> Black	<b>G</b> Grey
<b>FM</b> Natural Maple	<b>X</b> Espresso
<b>GP</b> Graphite	<b>CC</b> Classic Cherry
<b>M</b> Mahogany	<b>O</b> Medium Oak

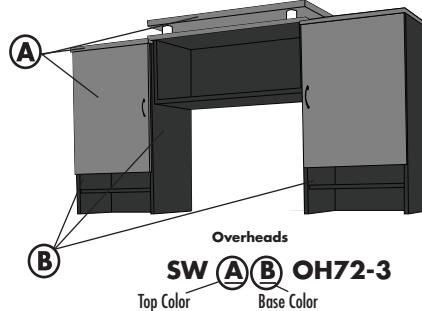
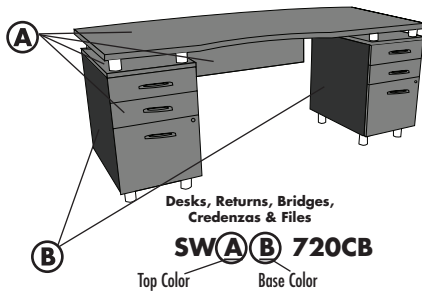

## PEDESTALS & FILE CABINETS

All cases are 3/4" thick core with thermally fused laminate on both sides and full 3 millimeter PVC AdvantEdge banding. Units fully assembled with dowels, glue, metal brackets, screws and mechanical fasteners.

## TOPS

All tops are 1 1/8" thick with thermally fused laminate surface, proper backing and full 3 millimeter PVC AdvantEdge banding as required. All bridge and return tops feature common gain direction with connecting units.

## PULL OPTIONS

Choose curvilinear pulls in brushed chrome, ebony or bright brass or oval nickel drawer/door pulls all constructed of solid metal. When ordering, use the corresponding pull designator at the beginning of the model number.

<b>SW</b>	Brushed Chrome
<b>SE</b>	Ebony
<b>SB</b>	Bright Brass
<b>SD</b>	Oval Nickel

## DRAWERS

All drawer fronts are constructed of 3/4" thick core with thermally fused laminate on both sides and full 3 millimeter PVC AdvantEdge banding as required. Drawer sides are 1/2" thick vinyl wrap with oak grain pattern. Drawer bottoms are 1/8" thick hardboard with oak grain pattern.

- All box drawers suspended on smooth-action steel, ball-bearing slides 3/4" extension
- File and lateral file drawers mounted on heavy-duty, ball-bearing, full-extension slides
- All file and lateral file drawers constructed for suspended filing with 25 lb. maximum weight for bottom-loading
- Drawers constructed with 5 sides for extra strength and durability. Drawer front is the fifth side and is removable for field-repair or hardware additions

## FILING

- All file drawers include pre-installed, black filing hardware with easy-adjust crossbar
- All file drawers accommodate letter-size filing front-to-back and letter or legal-size filing side-to-side
- All lateral file drawers accommodate letter or legal-size filing side-to-side and letter or legal size filing front-to-back

## LOCKS

- Desk/credenza pedestals feature single-key front locking, keyed alike
- Files and lateral file features single-key front locking
- All locks are keyed identical unless otherwise specified
- 'Key Different' option is \$21 list upcharge per lock. Locks/cores packaged to customer requirements
- Additional lead time for 'Key Different'
- For optional locking on overhead storage units with wood doors and no inserts, add **Y** to the end of the model number and add \$225 to the list price of units with four doors or \$150 for units with three adjoining doors

## ACCESSORIES *Factory Installed*

Certain accessories can be ordered installed prior to shipment. Add letter designator (C or K) at end of the desk or credenza model number:

- C** Center Drawer  
-Example: SWWC720C
- K** Keyboard Platform  
Example: SWWC725K

## LEGS

- Raised platform style pedestals achieved with 2" diameter anodized aluminum legs that are 3 1/2" high with heavy-duty leg levelers
- Column legs on desks, credenzas, tables and bridge tables are anodized aluminum 3" diameter and 28" high with heavy duty leg levelers
- Column legs on overhead storage units are anodized aluminum 2" diameter and rest on a steel mounting plate
- Spacers for raised tops on pedestals and tables are anodized aluminum 2" diameter and 2" high

## MODESTY PANELS

- Laminate modesty panels are 3/4" thick core thermally fused laminate on both sides with 3 millimeter PVC AdvantEdge banding as required
- White acrylic modesty panels are 1/4" thick.
- All modesty panels are suspended on 3 1/2" high aluminum spacers that are 1 1/4" diameter to give a 1" clearance for a floating top appearance

## PACKAGING

All units are properly packed in heavy-duty cartons with reinforced corner pads. All packaging conforms to, or exceeds, specifications as outlined in the Uniform Freight Classification.

## PALLETIZATION

See page 3.

## CARE AND CLEANING INSTRUCTIONS

Normal cleaning: Clean using a soft cloth and a good window cleaner which contains no ammonia, followed by wiping dry using a dry soft cloth.

**Specifications subject to change without notice.**





S W FM 700CB	
Pull	Finish

## Configurations

### U Shaped Workstation

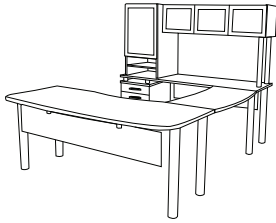

Description	Model Number	Qty	Frts. Class	Cubic Ft.	Ship Weight	Zone Pricing	1	2	3
Bow Front Table Desk	S_7230CBA 72" x 30" x 29"	1	85	12.0	155		1445	1467	1488
Left Pedestal Credenza	S_725LA 72" x 24" x 29"	1	125	37.0	200		1916	1945	1973
Connectible Bridge Top	S_484T 42" x 24" x 1.125"	1	92.5	4.0	50		389	395	401
Left Overhead Storage Unit	S_OH72LAD 72" x 17" x 36.5"	1	125	19.1	213		2242	2276	2309
Total:							5992	6083	6171

## Desks

### Bow Front Double Pedestal Desk

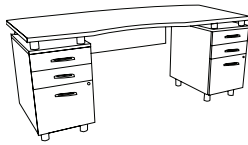

- Concave bow-front top design
- Laminate modesty panel suspended on aluminum spacers for a floating top appearance
- Two box/box/file pedestals
- Pre-installed filing hardware for legal or letter filing

<b>S_700CB</b> 72" X 30" X 29" Cubic Ft: 44.4 Ship Weight: 251	<b>2775</b>	<b>2817</b>	<b>2858</b>
Freight Class: 110			
<b>S_720CB</b> 72" X 36" X 29" Cubic Ft: 51.6 Ship Weight: 283	<b>2875</b>	<b>2918</b>	<b>2961</b>
Freight Class: 200			
<b>Pulls:</b> BRUSHED CHROME <b>SW</b> EBONY <b>SE</b> BRIGHT BRASS <b>SB</b> OVAL NICKEL <b>SD</b>			

### Bow Front Double Pedestal Desk, White Acrylic Modesty Panel

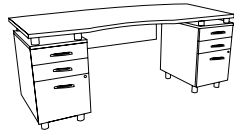

- Concave bow-front top
- White acrylic modesty panel suspended on aluminum spacers for a floating top appearance
- Two box/box/file pedestals
- Pre-installed filing hardware for legal or letter filing

<b>S_700CBA</b> 72" X 30" X 29" Cubic Ft: 44.4 Ship Weight: 251	<b>2795</b>	<b>2837</b>	<b>2879</b>
Freight Class: 110			
<b>S_720CBA</b> 72" X 36" X 29" Cubic Ft: 51.6 Ship Weight: 283	<b>2895</b>	<b>2938</b>	<b>2982</b>
Freight Class: 200			
<b>Pulls:</b> BRUSHED CHROME <b>SW</b> EBONY <b>SE</b> BRIGHT BRASS <b>SB</b> OVAL NICKEL <b>SD</b>			

### Double Pedestal Desk, Laminate Modesty Panel

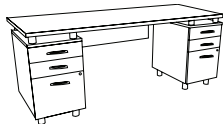

- Laminate modesty panel suspended on aluminum spacers for a floating top appearance
- Two box/box/file pedestals
- Pre-installed filing hardware for legal or letter filing

<b>S_700</b> 72" X 30" X 29" Cubic Ft: 44.4 Ship Weight: 250	<b>2675</b>	<b>2715</b>	<b>2755</b>
Freight Class: 110			
<b>S_660</b> 66" X 30" X 29" Cubic Ft: 40.2 Ship Weight: 210	<b>2625</b>	<b>2664</b>	<b>2704</b>
Freight Class: 200			
<b>Pulls:</b> BRUSHED CHROME <b>SW</b> EBONY <b>SE</b> BRIGHT BRASS <b>SB</b> OVAL NICKEL <b>SD</b>			

### Double Pedestal Desk, White Acrylic Modesty Panel

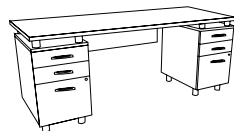

- White acrylic modesty panel suspended on aluminum spacers for a floating top appearance
- Two box/box/file pedestals
- Pre-installed filing hardware for legal or letter filing

<b>S_700A</b> 72" X 30" X 29" Cubic Ft: 44.4 Ship Weight: 250	<b>2695</b>	<b>2735</b>	<b>2776</b>
Freight Class: 110			
<b>S_660A</b> 66" X 30" X 29" Cubic Ft: 40.2 Ship Weight: 210	<b>2725</b>	<b>2766</b>	<b>2807</b>
Freight Class: 200			
<b>Pulls:</b> BRUSHED CHROME <b>SW</b> EBONY <b>SE</b> BRIGHT BRASS <b>SB</b> OVAL NICKEL <b>SD</b>			

### Bow Front Right Pedestal Desk

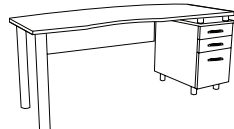

- Concave bow-front top design
- Laminate modesty panel suspended on aluminum spacers for a floating top appearance
- Box/box/file pedestal on right
- Two 3" diameter anodized aluminum column legs on left
- Pre-installed filing hardware for legal or letter filing

<b>S_7230CBR</b> 72" X 30" X 29" Cubic Ft: 44.4 Ship Weight: 215	<b>2125</b>	<b>2157</b>	<b>2189</b>
<b>S_7236CBR</b> 72" X 36" X 29" Cubic Ft: 51.6 Ship Weight: 247	<b>2225</b>	<b>2258</b>	<b>2292</b>
Freight Class: 200			
<b>Pulls:</b> BRUSHED CHROME <b>SW</b> EBONY <b>SE</b> BRIGHT BRASS <b>SB</b> OVAL NICKEL <b>SD</b>			

Freight Class: 200

## FINISH SELECTION

NATURAL MAPLE **FM** | WINDSOR CHERRY **WC** | MAHOGANY **M** | GRAPHITE **GP** |  
 MEDIUM OAK **O** | ASPEN **AP** | ESPRESSO **X** | BLACK **E** |  
 CLASSIC CHERRY **CC** | GREY **G** |

# SIN 711-2 STRATUS

### Bow Front Right Pedestal Desk, White Acrylic Modesty Panel

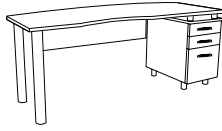

Freight Class: 200

- Concave bow-front top
- White acrylic modesty panel suspended on aluminum spacers for a floating top appearance
- Box/box/file pedestal on right
- Two 3" anodized aluminum column legs on left
- Pre-installed filing hardware for legal or letter filing

	Zone Pricing	1	2	3
<b>S_7230CBRA</b> 72" X 30" X 29" Cubic Ft: 44.4 Ship Weight: 215		<b>2225</b>	<b>2258</b>	<b>2292</b>
<b>S_7236CBRA</b> 72" X 36" X 29" Cubic Ft: 51.6 Ship Weight: 247		<b>2325</b>	<b>2360</b>	<b>2395</b>
<b>Pulls:</b>	BRUSHED CHROME <b>SW</b>	EBONY <b>SE</b>	BRIGHT BRASS <b>SB</b>	OVAL NICKEL <b>SD</b>

### Bow Front Left Pedestal Desk

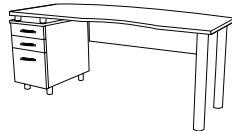

Freight Class: 200

- Concave bow-front top design
- Laminate modesty panel suspended on aluminum spacers for a floating top appearance
- Box/box/file pedestal on left
- Two 3" anodized aluminum column legs on right
- Pre-installed filing hardware for legal or letter filing

<b>S_7230CBL</b> 72" X 30" X 29" Cubic Ft: 44.4 Ship Weight: 215	<b>2125</b>	<b>2157</b>	<b>2189</b>	
<b>S_7236CBL</b> 72" X 36" X 29" Cubic Ft: 51.6 Ship Weight: 247	<b>2225</b>	<b>2258</b>	<b>2292</b>	
<b>Pulls:</b>	BRUSHED CHROME <b>SW</b>	EBONY <b>SE</b>	BRIGHT BRASS <b>SB</b>	OVAL NICKEL <b>SD</b>

### Bow Front Left Pedestal Desk, White Acrylic Modesty Panel

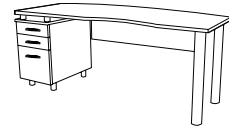

Freight Class: 200

- Concave bow-front top
- White acrylic modesty panel suspended on aluminum spacers for a floating top appearance
- Box/box/file pedestal on left
- Two 3" anodized aluminum column legs on right
- Pre-installed filing hardware for legal or letter filing

<b>S_7230CBLA</b> 72" X 30" X 29" Cubic Ft: 44.4 Ship Weight: 215	<b>2225</b>	<b>2258</b>	<b>2292</b>	
<b>S_7236CBLA</b> 72" X 36" X 29" Cubic Ft: 51.6 Ship Weight: 247	<b>2325</b>	<b>2360</b>	<b>2395</b>	
<b>Pulls:</b>	BRUSHED CHROME <b>SW</b>	EBONY <b>SE</b>	BRIGHT BRASS <b>SB</b>	OVAL NICKEL <b>SD</b>

### Right Pedestal Desk, Laminate Modesty Panel

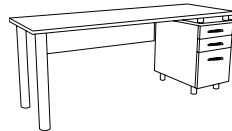

Freight Class: 200

- Laminate modesty panel suspended on aluminum spacers for a floating top appearance
- Box/box/file pedestal on right
- Two 3" anodized aluminum column legs on left
- Pre-installed filing hardware for legal or letter filing

<b>S_700R</b> 72" X 30" X 29" Cubic Ft: 44.4 Ship Weight: 215	<b>2025</b>	<b>2055</b>	<b>2086</b>	
<b>S_660R</b> 66" X 30" X 29" Cubic Ft: 40.2 Ship Weight: 160	<b>1975</b>	<b>2005</b>	<b>2034</b>	
<b>Pulls:</b>	BRUSHED CHROME <b>SW</b>	EBONY <b>SE</b>	BRIGHT BRASS <b>SB</b>	OVAL NICKEL <b>SD</b>

### Right Pedestal Desk, White Acrylic Modesty Panel

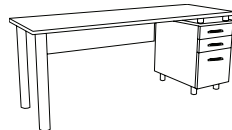

Freight Class: 200

- White acrylic modesty panel suspended on aluminum spacers for a floating top appearance
- Box/box/file pedestal on right
- Two 3" anodized aluminum column legs on left
- Pre-installed filing hardware for legal or letter filing

<b>S_700RA</b> 72" X 30" X 29" Cubic Ft: 44.4 Ship Weight: 215	<b>2125</b>	<b>2157</b>	<b>2189</b>	
<b>S_660RA</b> 66" X 30" X 29" Cubic Ft: 40.2 Ship Weight: 160	<b>2075</b>	<b>2106</b>	<b>2137</b>	
<b>Pulls:</b>	BRUSHED CHROME <b>SW</b>	EBONY <b>SE</b>	BRIGHT BRASS <b>SB</b>	OVAL NICKEL <b>SD</b>

### Left Pedestal Desk, Laminate Modesty Panel

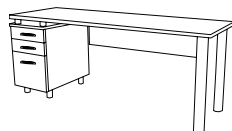

Freight Class: 200

- Laminate modesty panel suspended on aluminum spacers for a floating top appearance
- Box/box/file pedestal on left
- Two 3" anodized aluminum column legs on right
- Pre-installed filing hardware for legal or letter filing

<b>S_700L</b> 72" X 30" X 29" Cubic Ft: 44.4 Ship Weight: 215	<b>2025</b>	<b>2055</b>	<b>2086</b>	
<b>S_660L</b> 66" X 30" X 29" Cubic Ft: 40.2 Ship Weight: 160	<b>1975</b>	<b>2005</b>	<b>2034</b>	
<b>Pulls:</b>	BRUSHED CHROME <b>SW</b>	EBONY <b>SE</b>	BRIGHT BRASS <b>SB</b>	OVAL NICKEL <b>SD</b>

CONTEMPORARY LAMINATE



S W FM 700LA	
Pull	Finish

### Left Pedestal Desk, White Acrylic Modesty Panel

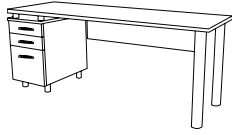

- White acrylic modesty panel suspended on aluminum spacers for a floating top appearance
- Box/box/file pedestal on left
- Two 3" anodized aluminum column legs on right
- Pre-installed filing hardware for legal or letter filing

Freight Class: 200

### Concave Bow Front Table Desk

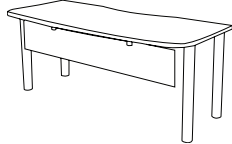

- Concave bow front design
- Laminate modesty panel suspended on aluminum spacers for a floating top appearance
- Four 3" anodized aluminum column legs
- Some assembly required

### Concave Bow Front Table Desk, White Acrylic Modesty Panel

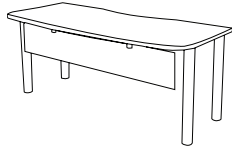

- Bow front top design
- White acrylic modesty panel suspended on aluminum spacers for a floating top appearance
- Four 3" anodized aluminum column legs
- Some assembly required

### Bow Front Mobile Table Desk



- Concave bow front top
- Laminate modesty panel suspended on aluminum spacers for a floating top appearance
- Four 3" anodized aluminum column legs with casters (2 lock)
- Some assembly required

Freight Class: 110

### Bow Front Mobile Table Desk, White Acrylic Modesty Panel



- Concave bow front top
- White acrylic modesty panel suspended on aluminum spacers for a floating top appearance
- Four 3" anodized aluminum column legs with casters (2 lock)
- Some assembly required

Freight Class: 110

### Rectangular Table Desk, Laminate Modesty Panel

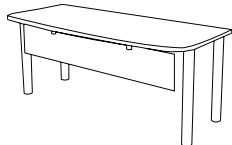

- Rectangular laminate top
- Laminate modesty panel suspended on aluminum spacers for a floating top appearance
- Four 3" anodized aluminum column legs
- Some assembly required

Freight Class: 110

### Table Desk, White Acrylic Modesty Panel

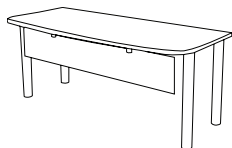

- Rectangular top
- White acrylic modesty panel suspended on aluminum spacers for a floating top appearance
- Four 3" anodized aluminum column legs with casters
- Some assembly required

Freight Class: 110

Zone Pricing

1      2      3

<b>S_700LA</b>	72" X 30" X 29"	Cubic Ft: 44.4	Ship Weight: 215	<b>2125</b>	<b>2157</b>	<b>2189</b>
----------------	-----------------	----------------	------------------	-------------	-------------	-------------

<b>S_660LA</b>	66" X 30" X 29"	Cubic Ft: 40.2	Ship Weight: 160	<b>2075</b>	<b>2106</b>	<b>2137</b>
----------------	-----------------	----------------	------------------	-------------	-------------	-------------

<b>Pulls:</b>	BRUSHED CHROME <b>SW</b>	EBONY <b>SE</b>	BRIGHT BRASS <b>SB</b>	OVAL NICKEL <b>SD</b>
---------------	--------------------------	-----------------	------------------------	-----------------------

<b>S_7230CB</b>	72" X 30" X 29"	Cubic Ft: 12	Ship Weight: 155	<b>1336</b>	<b>1356</b>	<b>1376</b>
-----------------	-----------------	--------------	------------------	-------------	-------------	-------------

Freight Class: 85

<b>S_7236CB</b>	72" X 36" X 29"	Cubic Ft: 13.5	Ship Weight: 105	<b>1436</b>	<b>1458</b>	<b>1479</b>
-----------------	-----------------	----------------	------------------	-------------	-------------	-------------

Freight Class: 110

<b>S_7230CBA</b>	72" X 30" X 29"	Cubic Ft: 12	Ship Weight: 155	<b>1445</b>	<b>1467</b>	<b>1488</b>
------------------	-----------------	--------------	------------------	-------------	-------------	-------------

Freight Class: 85

<b>S_7236CBA</b>	72" X 36" X 29"	Cubic Ft: 13.5	Ship Weight: 105	<b>1545</b>	<b>1568</b>	<b>1591</b>
------------------	-----------------	----------------	------------------	-------------	-------------	-------------

Freight Class: 110

<b>S_7230CBM</b>	72" X 30" X 29"	Cubic Ft: 11.4	Ship Weight: 98	<b>1332</b>	<b>1352</b>	<b>1372</b>
------------------	-----------------	----------------	-----------------	-------------	-------------	-------------

<b>S_7236CBM</b>	72" X 36" X 29"	Cubic Ft: 13.5	Ship Weight: 105	<b>1432</b>	<b>1453</b>	<b>1475</b>
------------------	-----------------	----------------	------------------	-------------	-------------	-------------

<b>S_7230CBMA</b>	72" X 30" X 29"	Cubic Ft: 11.4	Ship Weight: 98	<b>1441</b>	<b>1463</b>	<b>1484</b>
-------------------	-----------------	----------------	-----------------	-------------	-------------	-------------

<b>S_7236CBMA</b>	72" X 36" X 29"	Cubic Ft: 13.5	Ship Weight: 105	<b>1541</b>	<b>1564</b>	<b>1587</b>
-------------------	-----------------	----------------	------------------	-------------	-------------	-------------

<b>S_7230</b>	72" X 30" X 29"	Cubic Ft: 11.4	Ship Weight: 98	<b>1236</b>	<b>1255</b>	<b>1273</b>
---------------	-----------------	----------------	-----------------	-------------	-------------	-------------

<b>S_6630</b>	66" X 30" X 29"	Cubic Ft: 11.4	Ship Weight: 88	<b>1186</b>	<b>1204</b>	<b>1222</b>
---------------	-----------------	----------------	-----------------	-------------	-------------	-------------



<b>S_7230A</b>	72" X 30" X 29"	Cubic Ft: 11.4	Ship Weight: 98	<b>1345</b>	<b>1365</b>	<b>1385</b>
----------------	-----------------	----------------	-----------------	-------------	-------------	-------------

<b>S_6630A</b>	66" X 30" X 29"	Cubic Ft: 11.4	Ship Weight: 88	<b>1286</b>	<b>1305</b>	<b>1325</b>
----------------	-----------------	----------------	-----------------	-------------	-------------	-------------

## FINISH SELECTION

NATURAL MAPLE **FM** | WINDSOR CHERRY **WC** | MAHOGANY **M** | GRAPHITE **GP** |  
 MEDIUM OAK **O** | ASPEN **AP** | ESPRESSO **X** | BLACK **E** |  
 CLASSIC CHERRY **CC** | GREY **G** |

# SIN 711-2 STRATUS

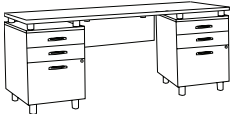
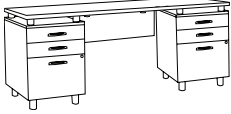
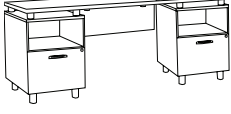
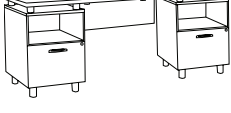
				Zone Pricing	1	2	3
 <ul style="list-style-type: none"> <li>Rectangular laminate top</li> <li>Laminate modesty panel suspended on aluminum spacers for a floating top appearance</li> <li>Four 3" anodized aluminum column legs on 3" casters for mobility (2 lock)</li> <li>Some assembly required</li> </ul>	<b>S_7230M</b>	72" X 30" X 29"	Cubic Ft: 11.4 Ship Weight: 98	<b>1232</b>	<b>1250</b>	<b>1269</b>	
	<b>S_6630M</b>	66" X 30" X 29"	Cubic Ft: 11.4 Ship Weight: 88	<b>1182</b>	<b>1200</b>	<b>1217</b>	
Freight Class: 110							
 <ul style="list-style-type: none"> <li>Rectangular top</li> <li>White acrylic modesty panel suspended on aluminum spacers for a floating top appearance</li> <li>Four 3" anodized aluminum column legs on 3" casters for mobility (2 lock)</li> <li>Some assembly required</li> </ul>	<b>S_7230MA</b>	72" X 30" X 29"	Cubic Ft: 11.4 Ship Weight: 98	<b>1341</b>	<b>1361</b>	<b>1381</b>	
	<b>S_6630MA</b>	66" X 30" X 29"	Cubic Ft: 11.4 Ship Weight: 88	<b>1282</b>	<b>1301</b>	<b>1320</b>	
Freight Class: 110							
<b>Credenzas</b>							
 <ul style="list-style-type: none"> <li>Anodized aluminum spacers create a floating top over pedestals</li> <li>Laminate modesty panel suspended on aluminum spacers</li> <li>Two box/box/file pedestals</li> <li>Pre-installed filing hardware for letter or legal filing</li> </ul>	<b>S_725</b>	72" X 24" X 29"	Cubic Ft: 35.7 Ship Weight: 234	<b>2655</b>	<b>2695</b>	<b>2735</b>	
	<b>S_625</b>	66" X 24" X 29"	Cubic Ft: 32 Ship Weight: 210	<b>2605</b>	<b>2644</b>	<b>2683</b>	
<b>Pulls:</b> BRUSHED CHROME <b>SW</b>   EBONY <b>SE</b>   BRIGHT BRASS <b>SB</b>   OVAL NICKEL <b>SD</b>							
Freight Class: 110							
 <ul style="list-style-type: none"> <li>Anodized aluminum spacers create a floating top over pedestals</li> <li>White acrylic modesty panel suspended on aluminum spacers</li> <li>Two box/box/file pedestals</li> <li>Pre-installed filing hardware for letter or legal filing</li> </ul>	<b>S_725A</b>	72" X 24" X 29"	Cubic Ft: 35.7 Ship Weight: 234	<b>2755</b>	<b>2796</b>	<b>2838</b>	
	<b>S_625A</b>	66" X 24" X 29"	Cubic Ft: 32 Ship Weight: 210	<b>2705</b>	<b>2746</b>	<b>2786</b>	
<b>Pulls:</b> BRUSHED CHROME <b>SW</b>   EBONY <b>SE</b>   BRIGHT BRASS <b>SB</b>   OVAL NICKEL <b>SD</b>							
Freight Class: 110							
 <ul style="list-style-type: none"> <li>Anodized aluminum spacers create a floating top over pedestals</li> <li>Laminate modesty panel suspended on aluminum spacers</li> <li>Two pedestals with one file drawer and one open storage compartment</li> <li>Pre-installed filing hardware for letter or legal filing</li> </ul>	<b>S_725FO</b>	72" X 24" X 29"	Cubic Ft: 35.7 Ship Weight: 234	<b>2455</b>	<b>2492</b>	<b>2529</b>	
	<b>S_625FO</b>	66" X 24" X 29"	Cubic Ft: 32 Ship Weight: 210	<b>2405</b>	<b>2441</b>	<b>2477</b>	
<b>Pulls:</b> BRUSHED CHROME <b>SW</b>   EBONY <b>SE</b>   BRIGHT BRASS <b>SB</b>   OVAL NICKEL <b>SD</b>							
Freight Class: 110							
 <ul style="list-style-type: none"> <li>White acrylic modesty panel suspended on aluminum spacers for a floating top appearance</li> <li>Two pedestals with one file drawer and one open storage compartment</li> <li>Pre-installed filing hardware for letter or legal filing</li> </ul>	<b>S_725FOA</b>	72" X 24" X 29"	Cubic Ft: 35.7 Ship Weight: 234	<b>2555</b>	<b>2593</b>	<b>2632</b>	
	<b>S_625FOA</b>	66" X 24" X 29"	Cubic Ft: 32 Ship Weight: 210	<b>2505</b>	<b>2543</b>	<b>2580</b>	
<b>Pulls:</b> BRUSHED CHROME <b>SW</b>   EBONY <b>SE</b>   BRIGHT BRASS <b>SB</b>   OVAL NICKEL <b>SD</b>							
Freight Class: 110							

CONTEMPORARY LAMINATE

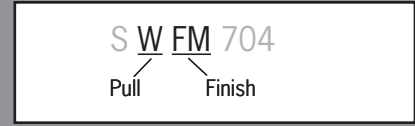

### Storage Credenza

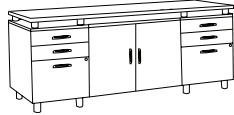

- 2" anodized aluminum spacers create a floating top
- Two box/box/file pedestals
- Pre-installed filing hardware for letter or legal filing
- Storage compartment with one adjustable shelf in center

Freight Class: 125

### Stratus Right Pedestal Credenza

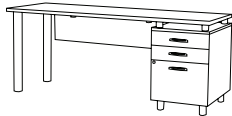

- 2" anodized aluminum spacers create a floating top over pedestal
- Laminate modesty panel suspended on aluminum spacers
- Box/box/file drawer pedestal on right
- Pre-installed filing hardware for letter or legal filing
- Two 3" anodized aluminum column legs on left

Freight Class: 125

### Right Pedestal Credenza, White Acrylic Modesty Panel

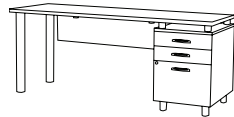

- White acrylic modesty panel suspended on aluminum spacers for a floating top appearance
- Pedestal on right with two box drawers and one file drawer
- Pre-installed filing hardware for letter or legal filing
- Two 3" anodized aluminum column legs on left

Freight Class: 125

### Stratus Left Pedestal Credenza

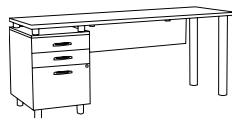

- 2" anodized aluminum spacers create a floating top over pedestal
- Laminate modesty panel suspended on aluminum spacers for a floating top appearance
- Box/box/file drawer pedestal on left
- Pre-installed filing hardware for letter or legal filing
- Two 3" anodized aluminum column legs right

Freight Class: 125

### Left Pedestal Credenza, White Acrylic Modesty Panel

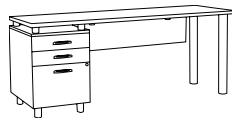

- White acrylic modesty panel suspended on aluminum spacers for a floating top appearance
- Pedestal on left with two box drawers and one file drawer
- Pre-installed filing hardware for letter or legal filing
- Two 3" anodized aluminum column legs on right

Freight Class: 125

Zone Pricing

1 2 3

<b>S_704</b>	72" X 24" X 29"	Cubic Ft: 35.7	Ship Weight: 234	<b>2955</b>	<b>2999</b>	<b>3044</b>
--------------	-----------------	----------------	------------------	-------------	-------------	-------------

<b>S_604</b>	66" X 24" X 29"	Cubic Ft: 32	Ship Weight: 210	<b>2855</b>	<b>2898</b>	<b>2941</b>
--------------	-----------------	--------------	------------------	-------------	-------------	-------------

<b>Pulls:</b>	BRUSHED CHROME <b>SW</b>	EBONY <b>SE</b>	BRIGHT BRASS <b>SB</b>	OVAL NICKEL <b>SD</b>
---------------	--------------------------	-----------------	------------------------	-----------------------

<b>S_725R</b>	72" X 24" X 29"	Cubic Ft: 37	Ship Weight: 200	<b>1816</b>	<b>1843</b>	<b>1870</b>
---------------	-----------------	--------------	------------------	-------------	-------------	-------------

<b>S_625R</b>	66" X 24" X 29"	Cubic Ft: 32	Ship Weight: 174	<b>1766</b>	<b>1792</b>	<b>1819</b>
---------------	-----------------	--------------	------------------	-------------	-------------	-------------

<b>Pulls:</b>	BRUSHED CHROME <b>SW</b>	EBONY <b>SE</b>	BRIGHT BRASS <b>SB</b>	OVAL NICKEL <b>SD</b>
---------------	--------------------------	-----------------	------------------------	-----------------------

<b>S_725RA</b>	72" X 24" X 29"	Cubic Ft: 37	Ship Weight: 200	<b>1916</b>	<b>1945</b>	<b>1973</b>
----------------	-----------------	--------------	------------------	-------------	-------------	-------------

<b>S_625RA</b>	66" X 24" X 29"	Cubic Ft: 32	Ship Weight: 174	<b>1866</b>	<b>1894</b>	<b>1922</b>
----------------	-----------------	--------------	------------------	-------------	-------------	-------------

<b>Pulls:</b>	BRUSHED CHROME <b>SW</b>	EBONY <b>SE</b>	BRIGHT BRASS <b>SB</b>	OVAL NICKEL <b>SD</b>
---------------	--------------------------	-----------------	------------------------	-----------------------

<b>S_725L</b>	72" X 24" X 29"	Cubic Ft: 37	Ship Weight: 200	<b>1816</b>	<b>1843</b>	<b>1870</b>
---------------	-----------------	--------------	------------------	-------------	-------------	-------------

<b>S_625L</b>	66" X 24" X 29"	Cubic Ft: 32	Ship Weight: 174	<b>1766</b>	<b>1792</b>	<b>1819</b>
---------------	-----------------	--------------	------------------	-------------	-------------	-------------

<b>Pulls:</b>	BRUSHED CHROME <b>SW</b>	EBONY <b>SE</b>	BRIGHT BRASS <b>SB</b>	OVAL NICKEL <b>SD</b>
---------------	--------------------------	-----------------	------------------------	-----------------------

<b>S_725LA</b>	72" X 24" X 29"	Cubic Ft: 37	Ship Weight: 200	<b>1916</b>	<b>1945</b>	<b>1973</b>
----------------	-----------------	--------------	------------------	-------------	-------------	-------------

<b>S_625LA</b>	66" X 24" X 29"	Cubic Ft: 32	Ship Weight: 174	<b>1866</b>	<b>1894</b>	<b>1922</b>
----------------	-----------------	--------------	------------------	-------------	-------------	-------------

<b>Pulls:</b>	BRUSHED CHROME <b>SW</b>	EBONY <b>SE</b>	BRIGHT BRASS <b>SB</b>	OVAL NICKEL <b>SD</b>
---------------	--------------------------	-----------------	------------------------	-----------------------



## FINISH SELECTION

NATURAL MAPLE **FM** | WINDSOR CHERRY **WC** | MAHOGANY **M** | GRAPHITE **GP** |  
 MEDIUM OAK **O** | ASPEN **AP** | ESPRESSO **X** | BLACK **E** |  
 CLASSIC CHERRY **CC** | GREY **G** |

# SIN 711-2 STRATUS

### Right File/Open Pedestal Credenza, Laminate Modesty Panel

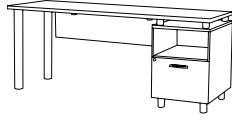

- Laminate modesty panel suspended on aluminum spacers for a floating top appearance
- One file drawer and one open storage compartment in pedestal on right
- Two 3" anodized aluminum column legs on left
- Pre-installed filing hardware for letter or legal filing

Freight Class: 125

### Right File/Open Pedestal Credenza, White Acrylic Modesty Panel

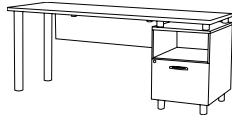

- Anodized aluminum spacers create a floating top over pedestal
- White acrylic modesty panel suspended on aluminum spacers
- One file drawer and one open storage compartment in pedestal on right
- Two 3" anodized aluminum column legs on left
- Pre-installed filing hardware for letter or legal filing

Freight Class: 125

### Left File/Open Pedestal Credenza, Laminate Modesty Panel

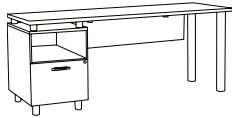

- Laminate modesty panel suspended on aluminum spacers for a floating top appearance
- One file drawer and one open storage compartment in pedestal on left
- Two 3" anodized aluminum column legs on right
- Pre-installed filing hardware for letter or legal filing

Freight Class: 125

### Left File/Open Pedestal Credenza, White Acrylic Modesty Panel

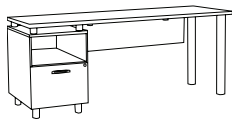

- Anodized aluminum spacers create a floating top over pedestals
- White acrylic modesty panel suspended on aluminum spacers
- One file drawer and one open storage compartment in pedestal on left
- Two 3" anodized aluminum column legs on right
- Pre-installed filing hardware for letter or legal filing

Freight Class: 125

### Right Lateral File Credenza, Laminate Modesty Panel



- Laminate modesty panel suspended on aluminum spacers for a floating top appearance
- One lateral file drawer and one open storage compartment in pedestal on right
- Two 3" anodized aluminum column legs on left
- Pre-installed filing hardware for letter or legal filing

Freight Class: 125

Zone Pricing

1

2

3

**S\_725RFO** 72" X 24" X 29" Cubic Ft: 35.7 Ship Weight: 184 **1716** **1742** **1767**

**S\_625RFO** 66" X 24" X 29" Cubic Ft: 32 Ship Weight: 174 **1666** **1691** **1716**

**Pulls:** BRUSHED CHROME **SW** EBONY **SE** BRIGHT BRASS **SB** OVAL NICKEL **SD**

**S\_725RFOA** 72" X 24" X 29" Cubic Ft: 35.7 Ship Weight: 184 **1816** **1843** **1870**

**S\_625RFOA** 66" X 24" X 29" Cubic Ft: 32 Ship Weight: 174 **1766** **1792** **1819**

**Pulls:** BRUSHED CHROME **SW** EBONY **SE** BRIGHT BRASS **SB** OVAL NICKEL **SD**

**S\_725LFO** 72" X 24" X 29" Cubic Ft: 35.7 Ship Weight: 184 **1716** **1742** **1767**

**S\_625LFO** 66" X 24" X 29" Cubic Ft: 32 Ship Weight: 174 **1666** **1691** **1716**

**Pulls:** BRUSHED CHROME **SW** EBONY **SE** BRIGHT BRASS **SB** OVAL NICKEL **SD**

**S\_725LFOA** 72" X 24" X 29" Cubic Ft: 35.7 Ship Weight: 184 **1816** **1843** **1870**

**S\_625LFOA** 66" X 24" X 29" Cubic Ft: 32 Ship Weight: 174 **1766** **1792** **1819**

**Pulls:** BRUSHED CHROME **SW** EBONY **SE** BRIGHT BRASS **SB** OVAL NICKEL **SD**

**S\_733R** 72" X 24" X 29" Cubic Ft: 35.7 Ship Weight: 199 **1925** **1954** **1983**

**S\_633R** 66" X 24" X 29" Cubic Ft: 32 Ship Weight: 189 **1875** **1903** **1931**

**Pulls:** BRUSHED CHROME **SW** EBONY **SE** BRIGHT BRASS **SB** OVAL NICKEL **SD**

**EXTRA THICK BOTTOM** \$80: **H**

CONTEMPORARY LAMINATE



S W FM 733RA	
Pull	Finish

Zone Pricing	1	2	3
--------------	---	---	---

### Right Lateral File Credenza, White Acrylic Modesty Panel

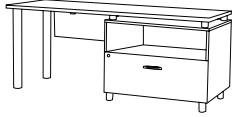

- White acrylic modesty panel suspended on aluminum spacers for a floating top appearance
- One lateral file drawer and one open storage compartment in pedestal on right
- Two 3" anodized aluminum column legs on left
- Pre-installed filing hardware for letter or legal filing

Freight Class: 125

<b>S_733RA</b>	72" X 24" X 29"	Cubic Ft: 35.7	Ship Weight: 199	<b>2025</b>	<b>2055</b>	<b>2086</b>
<b>S_633RA</b>	66" X 24" X 29"	Cubic Ft: 32	Ship Weight: 189	<b>1975</b>	<b>2005</b>	<b>2034</b>

<b>Pulls:</b>	BRUSHED CHROME <b>SW</b>	EBONY <b>SE</b>	BRIGHT BRASS <b>SB</b>	OVAL NICKEL <b>SD</b>
---------------	--------------------------	-----------------	------------------------	-----------------------

**EXTRA THICK BOTTOM** \$80: **H**

### Left Lateral File Credenza, Laminate Modesty Panel

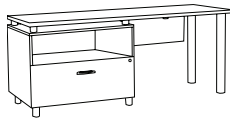

- Laminate modesty panel suspended on aluminum spacers for a floating top appearance
- One file drawer and one open storage compartment in pedestal on left
- Two 3" anodized aluminum column legs on right
- Pre-installed filing hardware for letter or legal filing

Freight Class: 125

<b>S_733L</b>	72" X 24" X 29"	Cubic Ft: 35.7	Ship Weight: 199	<b>1925</b>	<b>1954</b>	<b>1983</b>
<b>S_633L</b>	66" X 24" X 29"	Cubic Ft: 32	Ship Weight: 189	<b>1875</b>	<b>1903</b>	<b>1931</b>

<b>Pulls:</b>	BRUSHED CHROME <b>SW</b>	EBONY <b>SE</b>	BRIGHT BRASS <b>SB</b>	OVAL NICKEL <b>SD</b>
---------------	--------------------------	-----------------	------------------------	-----------------------

**EXTRA THICK BOTTOM** \$80: **H**

### Left Lateral File Credenza, White Acrylic Modesty Panel

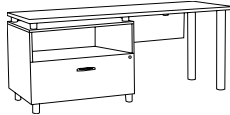

- White acrylic modesty panel suspended on aluminum spacers for a floating top appearance
- One file drawer and one open storage compartment in pedestal on left
- Two 3" anodized aluminum column legs on right
- Pre-installed filing hardware for letter or legal filing

Freight Class: 125

<b>S_733LA</b>	72" X 24" X 29"	Cubic Ft: 35.7	Ship Weight: 199	<b>2025</b>	<b>2055</b>	<b>2086</b>
<b>S_633LA</b>	66" X 24" X 29"	Cubic Ft: 32	Ship Weight: 189	<b>1975</b>	<b>2005</b>	<b>2034</b>

<b>Pulls:</b>	BRUSHED CHROME <b>SW</b>	EBONY <b>SE</b>	BRIGHT BRASS <b>SB</b>	OVAL NICKEL <b>SD</b>
---------------	--------------------------	-----------------	------------------------	-----------------------

**EXTRA THICK BOTTOM** \$80: **H**

### Right Bookcase Pedestal Credenza, Laminate Modesty Panel

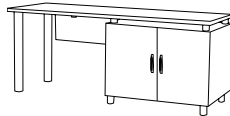

- Laminate modesty panel suspended on aluminum spacers for a floating top appearance
- Bookcase storage compartment with one adjustable shelf in pedestal on right
- Two 3" anodized aluminum column legs on left

Freight Class: 125

<b>S_734R</b>	72" X 24" X 29"	Cubic Ft: 35.7	Ship Weight: 199	<b>1995</b>	<b>2025</b>	<b>2055</b>
<b>S_634R</b>	66" X 24" X 29"	Cubic Ft: 32	Ship Weight: 185	<b>1945</b>	<b>1974</b>	<b>2003</b>

<b>Pulls:</b>	BRUSHED CHROME <b>SW</b>	EBONY <b>SE</b>	BRIGHT BRASS <b>SB</b>	OVAL NICKEL <b>SD</b>
---------------	--------------------------	-----------------	------------------------	-----------------------

### Right Bookcase Pedestal Credenza, White Acrylic Modesty Panel

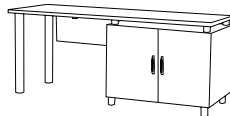

- White acrylic modesty panel suspended on aluminum spacers for a floating top appearance
- Bookcase storage compartment with one adjustable shelf in pedestal on right
- Two 3" anodized aluminum column legs on left

Freight Class: 125

<b>S_734RA</b>	72" X 24" X 29"	Cubic Ft: 35.7	Ship Weight: 199	<b>2095</b>	<b>2126</b>	<b>2158</b>
<b>S_634RA</b>	66" X 24" X 29"	Cubic Ft: 32	Ship Weight: 185	<b>2045</b>	<b>2076</b>	<b>2106</b>

<b>Pulls:</b>	BRUSHED CHROME <b>SW</b>	EBONY <b>SE</b>	BRIGHT BRASS <b>SB</b>	OVAL NICKEL <b>SD</b>
---------------	--------------------------	-----------------	------------------------	-----------------------

### Left Bookcase Pedestal Credenza, Laminate Modesty Panel

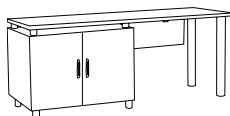

- Laminate modesty panel suspended on aluminum spacers for a floating top appearance
- Bookcase storage compartment with one adjustable shelf in pedestal on left
- Two 3" anodized aluminum column legs on right

Freight Class: 125

<b>S_734L</b>	72" X 24" X 29"	Cubic Ft: 35.7	Ship Weight: 199	<b>1995</b>	<b>2025</b>	<b>2055</b>
<b>S_634L</b>	66" X 24" X 29"	Cubic Ft: 32	Ship Weight: 185	<b>1945</b>	<b>1974</b>	<b>2003</b>

<b>Pulls:</b>	BRUSHED CHROME <b>SW</b>	EBONY <b>SE</b>	BRIGHT BRASS <b>SB</b>	OVAL NICKEL <b>SD</b>
---------------	--------------------------	-----------------	------------------------	-----------------------

## FINISH SELECTION

NATURAL MAPLE **FM** | WINDSOR CHERRY **WC** | MAHOGANY **M** | GRAPHITE **GP** |  
 MEDIUM OAK **O** | ASPEN **AP** | ESPRESSO **X** | BLACK **E** |  
 CLASSIC CHERRY **CC** | GREY **G** |

# SIN 711-2 STRATUS

Zone  
Pricing

1

2

3

### Left Bookcase Pedestal Credenza, White Acrylic Modesty Panel

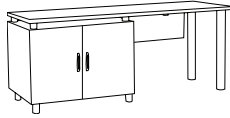

- White acrylic modesty panel suspended on aluminum spacers for a floating top appearance
- Bookcase storage compartment with one adjustable shelf in pedestal on left
- Two 3" anodized aluminum column legs on right

Freight Class: 125

**S\_734LA** 72" X 24" X 29" Cubic Ft: 35.7 Ship Weight: 199 **2095** **2126** **2158**

**S\_634LA** 66" X 24" X 29" Cubic Ft: 32 Ship Weight: 185 **2045** **2076** **2106**

**Pulls:** BRUSHED CHROME **SW** EBONY **SE** BRIGHT BRASS **SB** OVAL NICKEL **SD**

### Credenza Table, Laminate Modesty Panel

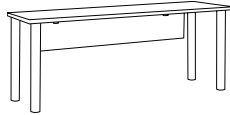

- Rectangular top
- Laminate modesty panel suspended on aluminum spacers for a floating top appearance
- Four 3" anodized aluminum column legs
- Some assembly required

Freight Class: 85

**S\_7224** 72" X 24" X 29" Cubic Ft: 8 Ship Weight: 98 **1225** **1243** **1262**

**S\_6624** 66" X 24" X 29" Cubic Ft: 7.3 Ship Weight: 80 **1175** **1193** **1210**

### Credenza Table, White Acrylic Modesty Panel

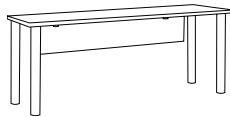

- Rectangular top
- White acrylic modesty panel suspended on aluminum spacers for a floating top appearance
- Four 3" anodized aluminum column legs
- Some assembly required

Freight Class: 85

**S\_7224A** 72" X 24" X 29" Cubic Ft: 8 Ship Weight: 98 **1325** **1345** **1365**

**S\_6624A** 66" X 24" X 29" Cubic Ft: 7.3 Ship Weight: 80 **1275** **1294** **1313**

### Mobile Credenza Table, Laminate Modesty Panel

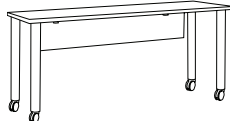

- Rectangular top
- Laminate modesty panel suspended on aluminum spacers for a floating top appearance
- Four 3" anodized aluminum column legs on 3" casters (2 lock)
- Some assembly required

Freight Class: 85

**S\_7224M** 72" X 24" X 29" Cubic Ft: 8 Ship Weight: 98 **1221** **1239** **1258**

**S\_6624M** 66" X 24" X 29" Cubic Ft: 7.3 Ship Weight: 80 **1171** **1189** **1206**

### Mobile Credenza Table, White Acrylic Modesty Panel

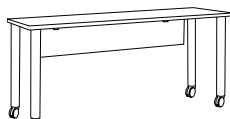

- Rectangular top
- White acrylic modesty panel suspended on aluminum spacers for a floating top appearance
- Four 3" anodized aluminum column legs on 3" casters (2 lock)
- Some assembly required

Freight Class: 85

**S\_7224MA** 72" X 24" X 29" Cubic Ft: 8 Ship Weight: 98 **1321** **1341** **1361**

**S\_6624MA** 66" X 24" X 29" Cubic Ft: 7.3 Ship Weight: 80 **1271** **1290** **1309**

## Returns

### Right Return, Laminate Modesty Panel



- Laminate modesty panel suspended on aluminum spacers for a floating top appearance
- Box/box/file drawer pedestal on right
- Pre-installed filing hardware for letter or legal filing
- Connects with desk or credenza on left

Freight Class: 110

**S\_722R** 48" X 20" X 29" Cubic Ft: 20.7 Ship Weight: 160 **1550** **1573** **1597**

**S\_622R** 42" X 20" X 29" Cubic Ft: 18.2 Ship Weight: 143 **1450** **1472** **1494**

**Pulls:** BRUSHED CHROME **SW** EBONY **SE** BRIGHT BRASS **SB** OVAL NICKEL **SD**

### Right Return, White Acrylic Modesty Panel



- White acrylic modesty panel suspended on aluminum spacers for a floating top appearance
- Box/box/file drawer pedestal on right
- Pre-installed filing hardware for letter or legal filing
- Connects with desk or credenza on left

Freight Class: 110

**S\_722RA** 48" X 20" X 29" Cubic Ft: 20.7 Ship Weight: 160 **1650** **1675** **1700**

**S\_622RA** 42" X 20" X 29" Cubic Ft: 18.2 Ship Weight: 143 **1550** **1573** **1597**

**Pulls:** BRUSHED CHROME **SW** EBONY **SE** BRIGHT BRASS **SB** OVAL NICKEL **SD**

CONTEMPORARY LAMINATE

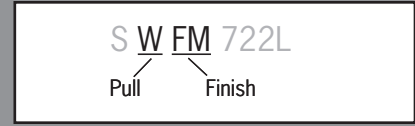

### Left Return, Laminate Modesty Panel

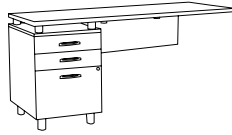

- Laminate modesty panel suspended on aluminum spacers for a floating top appearance
- Box/box/file drawer pedestal on left
- Pre-installed filing hardware for letter or legal filing
- Connects with desk or credenza on right

Freight Class: 110

				Zone Pricing		
				1	2	3
<b>S__722L</b>	48" X 20" X 29"	Cubic Ft: 20.7	Ship Weight: 160	<b>1550</b>	<b>1573</b>	<b>1597</b>
<b>S_ _622L</b>	42" X 20" X 29"	Cubic Ft: 18.2	Ship Weight: 143	<b>1450</b>	<b>1472</b>	<b>1494</b>
<b>Pulls:</b>	BRUSHED CHROME <b>SW</b>	EBONY <b>SE</b>	BRIGHT BRASS <b>SB</b>	OVAL NICKEL <b>SD</b>		

### Left Return, White Acrylic Modesty Panel



- White acrylic modesty panel suspended on aluminum spacers for a floating top appearance
- Box/box/file drawer pedestal on left
- Pre-installed filing hardware for letter or legal filing
- Connects with desk or credenza on right

Freight Class: 110

<b>S_ _722LA</b>	48" X 20" X 29"	Cubic Ft: 20.7	Ship Weight: 160	<b>1650</b>	<b>1675</b>	<b>1700</b>
<b>S_ _622LA</b>	42" X 20" X 29"	Cubic Ft: 18.2	Ship Weight: 143	<b>1550</b>	<b>1573</b>	<b>1597</b>
<b>Pulls:</b>	BRUSHED CHROME <b>SW</b>	EBONY <b>SE</b>	BRIGHT BRASS <b>SB</b>	OVAL NICKEL <b>SD</b>		

### Right Return, File/Open, Laminate Modesty Panel

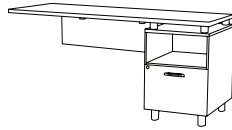

- Laminate modesty panel suspended on aluminum spacers for a floating top appearance
- Pedestal with one file drawer and one open storage compartment on right
- Pre-installed filing hardware for letter or legal filing
- Connects with desk or credenza on left

Freight Class: 110

<b>S_ _722RFO</b>	48" X 20" X 29"	Cubic Ft: 20.7	Ship Weight: 150	<b>1450</b>	<b>1472</b>	<b>1494</b>
<b>S_ _622RFO</b>	42" X 20" X 29"	Cubic Ft: 18.2	Ship Weight: 133	<b>1350</b>	<b>1370</b>	<b>1391</b>
<b>Pulls:</b>	BRUSHED CHROME <b>SW</b>	EBONY <b>SE</b>	BRIGHT BRASS <b>SB</b>	OVAL NICKEL <b>SD</b>		

### Right Return, File/Open, White Acrylic Modesty Panel

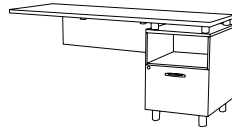

- White acrylic modesty panel suspended on aluminum spacers for a floating top appearance
- Pedestal with one file drawer and one open storage compartment on right
- Pre-installed filing hardware for letter or legal filing
- Connects with desk or credenza on left

Freight Class: 110

<b>S_ _722RFOA</b>	48" X 20" X 29"	Cubic Ft: 20.7	Ship Weight: 150	<b>1550</b>	<b>1573</b>	<b>1597</b>
<b>S_ _622RFOA</b>	42" X 20" X 29"	Cubic Ft: 18.2	Ship Weight: 133	<b>1450</b>	<b>1472</b>	<b>1494</b>
<b>Pulls:</b>	BRUSHED CHROME <b>SW</b>	EBONY <b>SE</b>	BRIGHT BRASS <b>SB</b>	OVAL NICKEL <b>SD</b>		

### Left Return, File/Open, Laminate Modesty Panel

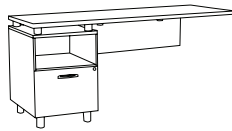

- Laminate modesty panel suspended on aluminum spacers for a floating top appearance
- Pedestal with one file drawer and one open storage compartment on left
- Pre-installed filing hardware for letter or legal filing
- Connects with desk or credenza on right

Freight Class: 110

<b>S_ _722LFO</b>	48" X 20" X 29"	Cubic Ft: 20.7	Ship Weight: 150	<b>1450</b>	<b>1472</b>	<b>1494</b>
<b>S_ _622LFO</b>	42" X 20" X 29"	Cubic Ft: 18.2	Ship Weight: 133	<b>1350</b>	<b>1370</b>	<b>1391</b>
<b>Pulls:</b>	BRUSHED CHROME <b>SW</b>	EBONY <b>SE</b>	BRIGHT BRASS <b>SB</b>	OVAL NICKEL <b>SD</b>		

### Left Return, File/Open, White Acrylic Modesty Panel

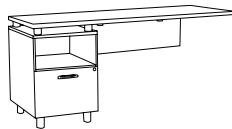

- White acrylic modesty panel suspended on aluminum spacers for a floating top appearance
- Pedestal with one file drawer and one open storage compartment on left
- Pre-installed filing hardware for letter or legal filing
- Connects with desk or credenza on right

Freight Class: 110

<b>S_ _722LFOA</b>	48" X 20" X 29"	Cubic Ft: 20.7	Ship Weight: 150	<b>1550</b>	<b>1573</b>	<b>1597</b>
<b>S_ _622LFOA</b>	42" X 20" X 29"	Cubic Ft: 18.2	Ship Weight: 133	<b>1450</b>	<b>1472</b>	<b>1494</b>
<b>Pulls:</b>	BRUSHED CHROME <b>SW</b>	EBONY <b>SE</b>	BRIGHT BRASS <b>SB</b>	OVAL NICKEL <b>SD</b>		

## FINISH SELECTION

NATURAL MAPLE **FM** | WINDSOR CHERRY **WC** | MAHOGANY **M** | GRAPHITE **GP** |  
 MEDIUM OAK **O** | ASPEN **AP** | ESPRESSO **X** | BLACK **E** |  
 CLASSIC CHERRY **CC** | GREY **G** |

# SIN 711-2 STRATUS

Zone  
Pricing

1

2

3

## Bridges & Tables

### Bridge/Table, Bow Top

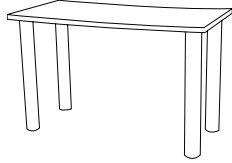

- Concave bow top design
- Freestanding or connectable to desk and credenza
- Four 3" diameter anodized aluminum column legs
- Some assembly required

Freight Class: 85

<b>S_484</b>	42" X 24" X 29"	Cubic Ft: 5	Ship Weight: 75	<b>1037</b>	<b>1053</b>	<b>1068</b>
<b>S_485</b>	48" X 24/20" X 29"	Cubic Ft: 5	Ship Weight: 98	<b>1136</b>	<b>1153</b>	<b>1170</b>

### Mobile Bridge/Table, Bow Top

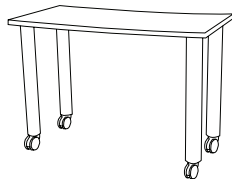

- Concave bow top design
- Four 3" anodized aluminum column legs on 3" casters (2 lock)
- Some assembly required

Freight Class: 85

<b>S_484M</b>	42" X 24" X 29"	Cubic Ft: 5	Ship Weight: 75	<b>1033</b>	<b>1048</b>	<b>1064</b>
<b>S_485M</b>	48" X 24/20" X 29"	Cubic Ft: 5	Ship Weight: 98	<b>1132</b>	<b>1149</b>	<b>1166</b>

### Connectable Bridge, Bow Top



- Concave bow top design
- Connects desks and credenzas

<b>S_484T</b>	42" X 24" X 29"	Cubic Ft: 5	Ship Weight: 50	<b>389</b>	<b>395</b>	<b>401</b>
---------------	-----------------	-------------	-----------------	------------	------------	------------

Freight Class: 92.5

<b>S_485T</b>	48" X 24/20" X 29"	Cubic Ft: 5	Ship Weight: 60	<b>462</b>	<b>469</b>	<b>476</b>
---------------	--------------------	-------------	-----------------	------------	------------	------------

Freight Class: 85

### Rectangular Table Bridge

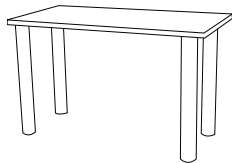

- Rectangular top
- Four 3" anodized aluminum column legs
- Some assembly required

Freight Class: 85

<b>S_483</b>	42" X 20" X 29"	Cubic Ft: 5	Ship Weight: 75	<b>937</b>	<b>951</b>	<b>965</b>
--------------	-----------------	-------------	-----------------	------------	------------	------------

<b>S_486</b>	48" X 20" X 29"	Cubic Ft: 5	Ship Weight: 98	<b>1036</b>	<b>1052</b>	<b>1067</b>
--------------	-----------------	-------------	-----------------	-------------	-------------	-------------

### Rectangular Mobile Bridge Table

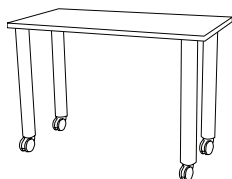

- Rectangular top
- Four 3" anodized aluminum column legs on 3" casters (2 lock)
- Some assembly required

Freight Class: 85

<b>S_483M</b>	42" X 20" X 29"	Cubic Ft: 5	Ship Weight: 75	<b>933</b>	<b>947</b>	<b>961</b>
---------------	-----------------	-------------	-----------------	------------	------------	------------

<b>S_486M</b>	48" X 20" X 29"	Cubic Ft: 5	Ship Weight: 98	<b>1032</b>	<b>1047</b>	<b>1063</b>
---------------	-----------------	-------------	-----------------	-------------	-------------	-------------

### Rectangular Connectable Bridge Top

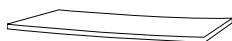

- Rectangular bridge top connects desks and credenzas

Freight Class: 85

<b>S_483T</b>	42" X 20" X 29"	Cubic Ft: 5	Ship Weight: 50	<b>289</b>	<b>293</b>	<b>298</b>
---------------	-----------------	-------------	-----------------	------------	------------	------------

<b>S_486T</b>	48" X 20" X 29"	Cubic Ft: 5	Ship Weight: 60	<b>362</b>	<b>367</b>	<b>373</b>
---------------	-----------------	-------------	-----------------	------------	------------	------------

CONTEMPORARY LAMINATE





S		W		FM		OH72-3	
Pull				Finish			

Zone Pricing	1	2	3
--------------	---	---	---

## Overhead Storage

### Tri-Level Overhead Storage

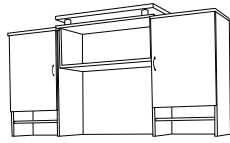

- Two tower storage compartments
- Each tower has one adjustable shelf behind door and one adjustable shelf in open section under door
- Open center bridge cabinet with floating top on 2" anodized aluminum spacers
- Ships in 3 cartons
- Some assembly required

Freight Class: 125

**S\_OH72-3** 72" X 17" X 39.75" Cubic Ft: 29.2 Ship Weight: 247 **2242** **2276** **2309**

**Pulls:** BRUSHED CHROME **SW** EBONY **SE** BRIGHT BRASS **SB** OVAL NICKEL **SD**

### Right Overhead Storage, 4 Aluminum/Frosted Doors

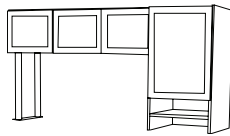

- Storage behind one large and three small doors
- Aluminum framed doors with frosted acrylic inserts
- Two adjustable shelves
- Two anodized aluminum column legs on left
- Some assembly required

Freight Class: 125

**S\_OH72RAD** 72" X 17" X 36.5" Cubic Ft: 19.1 Ship Weight: 213 **2242** **2276** **2309**

### Left Overhead Storage, 4 Aluminum/Frosted Doors

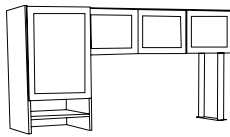

- Storage behind one large and three small doors
- Aluminum framed doors with frosted acrylic inserts
- Two adjustable shelves
- Two anodized aluminum column legs on right
- Some assembly required

Freight Class: 125

**S\_OH72LAD** 72" X 17" X 36.5" Cubic Ft: 19.1 Ship Weight: 213 **2242** **2276** **2309**

### Right Overhead Storage, 4 Aluminum/Acrylic Doors

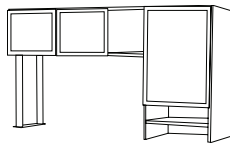

- Storage behind one large and two small doors
- Aluminum framed doors with frosted acrylic inserts
- Two adjustable shelves
- Two anodized aluminum column legs on left
- Some assembly required

Freight Class: 125

**S\_OH66RAD** 66" X 17" X 36.5" Cubic Ft: 19.1 Ship Weight: 208 **2142** **2174** **2206**

### Left Overhead Storage, 4 Aluminum/Acrylic Doors

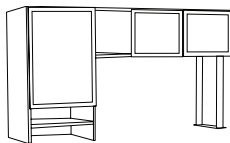

- Storage behind one large and two small doors
- Aluminum framed doors with frosted acrylic inserts
- Two adjustable shelves
- Two anodized aluminum column legs on right
- Some assembly required

Freight Class: 125

**S\_OH66LAD** 66" X 17" X 36.5" Cubic Ft: 19.1 Ship Weight: 208 **2142** **2174** **2206**

### Right Overhead Storage, 4 Laminate Doors

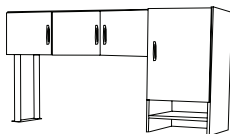

- Storage behind one large and three small laminate doors
- Two adjustable shelves
- Two anodized aluminum column legs on left
- Some assembly required

Freight Class: 125

**S\_OH72R** 72" X 17" X 36.5" Cubic Ft: 19.1 Ship Weight: 213 **1680** **1705** **1730**

**Pulls:** BRUSHED CHROME **SW** EBONY **SE** BRIGHT BRASS **SB** OVAL NICKEL **SD**

**Locks** \$225: **Y**

## FINISH SELECTION

NATURAL **FM** | WINDSOR CHERRY **WC** | MAHOGANY **M** | GRAPHITE **GP** |  
 MEDIUM OAK **O** | ASPEN **AP** | ESPRESSO **X** | BLACK **E** |  
 CLASSIC CHERRY **CC** | GREY **G** |

# SIN 711-2 STRATUS

	Zone Pricing	1	2	3
<b>Left Overhead Storage, 4 Laminate Doors</b>				
<b>S_ _OH72L</b> 72" X 17" X 36.5" Cubic Ft: 19.1 Ship Weight: 213		<b>1680</b>	<b>1705</b>	<b>1730</b>
<b>Pulls:</b> BRUSHED CHROME <b>SW</b>   EBONY <b>SE</b>   BRIGHT BRASS <b>SB</b>   OVAL NICKEL <b>SD</b>				
<b>Locks</b> \$225: <b>Y</b>				
Freight Class: 125				

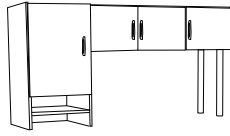

- Storage behind one large and three small laminate doors
- Two adjustable shelves
- Two anodized aluminum column legs on right
- Some assembly required

<b>Right Overhead Storage, Laminate Doors</b>				
<b>S_ _OH66R</b> 66" X 17" X 36.5" Cubic Ft: 19.1 Ship Weight: 208		<b>1580</b>	<b>1604</b>	<b>1627</b>
<b>Pulls:</b> BRUSHED CHROME <b>SW</b>   EBONY <b>SE</b>   BRIGHT BRASS <b>SB</b>   OVAL NICKEL <b>SD</b>				
<b>Locks</b> \$150: <b>Y</b>				
Freight Class: 125				

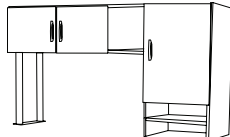

- Storage behind one large and two small laminate doors
- Two adjustable shelves
- Two anodized aluminum column legs on left
- Some assembly required

<b>Left Overhead Storage, Laminate Doors</b>				
<b>S_ _OH66L</b> 66" X 17" X 36.5" Cubic Ft: 19.1 Ship Weight: 208		<b>1580</b>	<b>1604</b>	<b>1627</b>
<b>Pulls:</b> BRUSHED CHROME <b>SW</b>   EBONY <b>SE</b>   BRIGHT BRASS <b>SB</b>   OVAL NICKEL <b>SD</b>				
<b>Locks</b> \$150: <b>Y</b>				
Freight Class: 125				

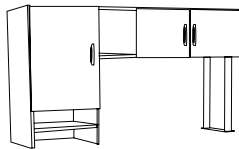

- Storage behind one large and two small laminate doors
- Two adjustable shelves
- Two anodized aluminum column legs on right
- Some assembly required

## Files, Cabinets & Tables

<b>Lateral File</b>				
<b>S_ _326</b> 32.75" X 24" X 29" Cubic Ft: 13.5 Ship Weight: 120		<b>575</b>	<b>584</b>	<b>592</b>
<b>Pulls:</b> BRUSHED CHROME <b>SW</b>   EBONY <b>SE</b>   BRIGHT BRASS <b>SB</b>   OVAL NICKEL <b>SD</b>				
<b>EXTRA THICK BOTTOM</b> \$80: <b>H</b>				
Freight Class: 125				



- Anodized aluminum top spacers create a floating top
- One lateral file drawer
- One open storage shelf
- Pre-installed filing hardware for letter or legal filing
- Lock on front standard

<b>Two Door Storage Cabinet</b>				
<b>S_ _732</b> 32.75" X 24" X 29" Cubic Ft: 13.4 Ship Weight: 120		<b>540</b>	<b>548</b>	<b>556</b>
<b>Pulls:</b> BRUSHED CHROME <b>SW</b>   EBONY <b>SE</b>   BRIGHT BRASS <b>SB</b>   OVAL NICKEL <b>SD</b>				
<b>Locks</b> \$75: <b>Y</b>				
Freight Class: 125				



- Anodized aluminum top spacers create a floating top
- Storage compartment with one adjustable shelf
- Two hinged laminate doors

CONTEMPORARY LAMINATE



S	W	FM	20S
Pull		Finish	

### Mobile Pedestal with Upholstered Seat



- Upholstered seat on anodized aluminum top spacers create a floating top
- Box/file pedestal with pre-installed filing hardware for letter or legal filing
- Lock on front
- Four casters (2 locking)

**S\_ \_20S** 16" X 22.25" X 26" Cubic Ft: 10.2 Ship Weight: 85 Fabric Grade

Zone Pricing	1	2	3
1	877	890	903
2	891	904	917
3	906	920	934
4	922	936	950
5	936	950	964
6	954	968	983
7	973	988	1002
8	992	1007	1022
9	1011	1026	1041
10	1034	1050	1065
L	1074	1090	1106
LL	1184	1202	1220

<b>Pulls:</b>	BRUSHED CHROME <b>SW</b>	EBONY <b>SE</b>	BRIGHT BRASS <b>SB</b>	OVAL NICKEL <b>SD</b>
---------------	--------------------------	-----------------	------------------------	-----------------------

Freight Class: 100

### Mobile Pedestal



- Anodized aluminum top spacers create a floating top
- Box/file pedestal with pre-installed filing hardware for letter or legal filing
- Lock on front
- Four casters (2 locking)

**S\_ \_20** 16" X 22.25" X 26" Cubic Ft: 10.2 Ship Weight: 85 **850 863 876**

<b>Pulls:</b>	BRUSHED CHROME <b>SW</b>	EBONY <b>SE</b>	BRIGHT BRASS <b>SB</b>	OVAL NICKEL <b>SD</b>
---------------	--------------------------	-----------------	------------------------	-----------------------

Freight Class: 100

### Curved Coffee Table with Floating Tops

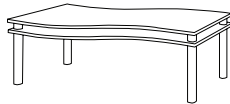

- Two curved 3/4" thick thermally fused laminate tops
- Four anodized aluminum top spacers for a floating top appearance
- Four anodized aluminum column legs with floor protecting glides
- Available in all Stratus finishes
- Can be ordered with tops in different finishes specify finish for each top
- Assembly required

**S\_ \_CT20** 48" X 24" X 16" Cubic Ft: 21.4 Ship Weight: 43 **1576 1600 1623**

Freight Class: 250

## CHARACTERISTICS

*Pedestals, Credenzas, File Cabinets and Storage Units:* Pedestal cases are ¾" thick core surfaced on both sides with laminate and edge banded as required. Units fully assembled with dowels, glue, wood cleats, metal brackets and screws. Series features full modesty panels.

## FINISHES

All models available in Mahogany and Windsor Cherry wood grain thermally fused laminate on vertical surfaces with high pressure laminate (HPL) Tops.

## TOPS

All tops are surfaced in high-gloss high pressure laminate. All bridge and return tops feature common grain direction with desk/credenza as well as reverse coped edges for smooth work surface connection with desk/credenza. All tops are 1¾" thick, and are properly backed. All tops feature softly rounded hardwood edges on all four sides. (Note: Tops are high gloss only).

## PEDESTALS

Vitality features both full pedestal and ¾ pedestal models. The full pedestal drawer configuration is a box/box/file on all desks, and a file/file on all credenzas and returns. Four preinstalled leveling glides in each pedestal. The ¾ pedestal drawer configuration is box/file.

## PULLS

Choose from 3 drawer/door pull options.

- A** Antique Brass
- E** Ebony
- W** Silver

## SPECIFICATIONS-Drawers

All drawer fronts are constructed of ¾" thick core surfaced on both sides with laminate and edge banded as required. Drawer sides are ½" thick, grain printed in an oak finish. Drawer bottoms are ⅝" thick hardboard grain printed in an oak finish.

- All box drawers are ¾ extension suspended on smooth action metal slides with steel ball bearings
- All file drawers and file cabinet drawers are mounted on heavy-duty ball bearing, full-extension slides
- All full pedestal desks are equipped with writing slides
- Black filing hardware includes pre-installed rails with easy-adjust crossbar
- All ¾ pedestal file drawers allow letter filing front-to-back and letter/legal filing side-to-side
- All full pedestal file drawers allow legal filing front-to-back and letter/legal filing side-to-side
- All 36" lateral file drawers allow letter and/

or legal filing front-to-back and side-to-side

- 30" and 32" lateral file drawers allow legal filing side-to-side and letter filing front-to-back
- Maximum weight for bottom loading is 25lbs.
- Drawers are constructed with 5 sides for extra strength and durability. The drawer front is the 5th side and is removable in the field for repairs or hardware additions

## WIRE MANAGEMENT

All grommets are rectangular and made of black high impact poly resin. See features for number of grommets and location. Additional grommets can be added for extended wire management capability at \$106 list per grommet. Includes factory cut and installed grommet and black sleeve. Call for special quote. Specify location and quote number with order.

## LOCKS

- Individually locking pedestals are standard on all desks and credenzas
- Two drawer lateral files feature individually locking drawers
- Four drawer lateral files feature central locking and are keyed different than other locks due to the anti-tilt mechanism inside the unit
- All locks are keyed identical unless otherwise specified
- 'Key Different' option is \$21 list upcharge per lock. Locks/cores packaged to customer requirements
- Additional lead time for 'Key Different'
- For optional locking on overhead storage units with four wood doors, add **Y** to the end of the model number and add \$150 to the list price of unit

## PANELS

¾ pedestal units, bookcases and storage units utilize 1" thick end panels. Heavy-duty adjustable nylon leveling glides are in 5" steel plate on all units. Modesty panels are ¾" thick core.

## TACK BOARDS

Fabric covered tackable board may be ordered separately to fit inside hutch. They can be ordered with any fabric to match your office chairs except leather or vinyl. See pages 182-184.

## ACCESSORIES *Factory Installed*

Certain accessories can be ordered installed prior to shipment. Add letter designator (C or K) at end of the desk or credenza model number:

- C** Center Drawer  
*Example: VWM7202BFC*
- K** Keyboard Platform  
*Example: VWM704K*

## QUICKSHIP

Quick Ship is not available on any items ordered with option.

## PACKING

All units are properly packed in heavy duty cartons with heavy duty corner pads. All packaging conforms to or exceeds specifications as outlined in the Uniform Freight Classification.

All desks, credenzas, files, and overhead storage units are shipped set up. Modular L-shaped, and U-shaped workstations are shipped in multiple cartons and require connection in the field.

## PALLETIZATION

See page 3.

## CARE AND CLEANING INSTRUCTIONS

**Normal cleaning:** Clean using a soft cloth and a good window cleaner which contains no ammonia, followed by wiping dry using a dry soft cloth.

**Specifications subject to change without notice.**



## Configurations

Zone Pricing

1

2

3

### Executive L Unit 3/4 Pedestal



72" x 84" x 29"

Description	Model Number	Qty	Frt.Class	Cubic Ft.	Ship Weight	1	2	3
Right Pedestal Desk	V_721R 72" x 36" x 29"	1	200	51.6	250	1848	1876	1903
Desk Height Left Return	V_722L 48" x 24" x 29"	1	110	23.5	159	1277	1296	1315
Total:				75.10	409	3125	3172	3218

### Executive L Unit Full Pedestal

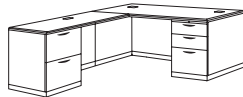

72" x 84" x 29"

Description	Model Number	Qty	Frt.Class	Cubic Ft.	Ship Weight	1	2	3
Right Pedestal Desk	V_721R2BF 72" x 36" x 29"	1	110	51.6	298	2343	2378	2413
Desk Height Left Return	V_722LF 48" x 24" x 29"	1	110	24.3	173	1588	1612	1636
Total:				75.90	471	3931	3990	4049

### Executive U Unit 3/4 Pedestal



72" x 108" x 65.5"

Description	Model Number	Qty	Frt.Class	Cubic Ft.	Ship Weight	1	2	3
Right Pedestal Desk	V_721R 72" x 36" x 29"	1	200	51.6	250	1848	1876	1903
Desk Height Bridge	V_485 48" x 24" x 29"	1	100	4.0	80	790	802	814
Left Pedestal Credenza	V_725L 72" x 24" x 29"	1	125	35.7	175	1750	1776	1803
Overhead Storage Unit	V_737 71" x 18" x 36.5"	1	125	33.6	229	1903	1932	1960
Total:				124.90	734	6291	6386	6480

### Executive U Unit Full Pedestal

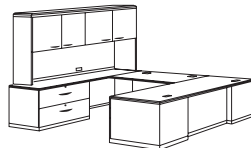

72" x 108" x 65.5"

Description	Model Number	Qty	Frt.Class	Cubic Ft.	Ship Weight	1	2	3
Right Pedestal Desk	V_721R2BF 72" x 36" x 29"	1	110	51.6	298	2343	2378	2413
Lateral File Credenza	V_733L 72" x 24" x 29"	1	125	35.7	253	2130	2162	2194
Desk Height Bridge	V_485 48" x 24" x 29"	1	100	4.0	80	790	802	814
Overhead Storage Unit	V_737 71" x 18" x 36.5"	1	125	33.6	229	1903	1932	1960
Total:				124.90	860	7166	7274	7381

### Executive U Unit with Peninsula Desk



72" x 108" x 65.5"

Description	Model Number	Qty	Frt.Class	Cubic Ft.	Ship Weight	1	2	3
Peninsula Desk	V_799 72" x 36" x 29"	1	125	51.6	166	1861	1889	1917
Lateral File Credenza	V_733L 72" x 24" x 29"	1	125	35.7	253	2130	2162	2194
Desk Height Bridge	V_485 48" x 24" x 29"	1	100	4.0	80	790	802	814
Overhead Storage Unit	V_737 71" x 18" x 36.5"	1	125	33.6	229	1903	1932	1960
Total:				124.90	728	6684	6785	6885

UNIT	KNEESPACE	OVERHANG
72" Double Full Pedestal Desk	36-1/4"	4"
66" Double Full Pedestal Desk	30-1/4"	4"
72" Double Full Pedestal Credenza	36-1/4"	1"
72" Double 3/4 Pedestal Desk	38-1/4"	10-3/8"
66" Double 3/4 Pedestal Desk	32-1/4"	4-3/8"
72" Double 3/4 Pedestal Credenza	38-1/4"	1"

TRANSITIONAL LAMINATE



**Executive Office  
 3/4 Pedestal**

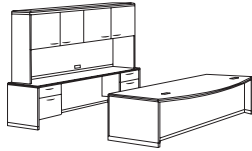

72" x 108" x 65.5"

Description	Model Number	Qty	Frft.Class	Cubic Ft.	Ship Weight	Zone Pricing		
						1	2	3
3/4 Double Pedestal Bow Front Desk	V__720B 72" x 36" x 29"	1	110	51.6	298	<b>2447</b>	<b>2484</b>	<b>2520</b>
3/4 Pedestal Computer Credenza	V__704 72" x 24" x 29"	1	110	35.7	263	<b>2024</b>	<b>2054</b>	<b>2085</b>
Overhead Storage Unit	V__737 71" x 18" x 36.5"	1	125	33.6	229	<b>1903</b>	<b>1932</b>	<b>1960</b>
Total:						<b>6374</b>	<b>6470</b>	<b>6565</b>

**Executive Office  
 Full Pedestal**

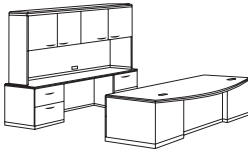

72" x 108" x 65.5"

Description	Model Number	Qty	Frft.Class	Cubic Ft.	Ship Weight	1	2	3
Double Pedestal Bow Front Desk	V__720B2BF 72" x 36" x 29"	1	110	51.6	360	<b>2992</b>	<b>3037</b>	<b>3082</b>
Full Pedestal Computer Credenza	V__704F 72" x 24" x 29"	1	110	35.7	279	<b>2394</b>	<b>2430</b>	<b>2466</b>
Overhead Storage Unit	V__737 71" x 18" x 36.5"	1	125	33.6	229	<b>1903</b>	<b>1932</b>	<b>1960</b>
Total:						<b>7289</b>	<b>7399</b>	<b>7508</b>

**Desks**

**Bow Front Double Pedestal Desk**



Freight Class: 110

- Four box drawers
- Two file drawers, letter or legal filing
- Two writing shelves
- Individual locking pedestals
- Two grommets in top

V__720B2BF	72" X 36" X 29"	Cubic Ft: 51.6	Ship Weight: 360	<b>2992</b>	<b>3037</b>	<b>3082</b>
				<b>Center Drawer C</b>	179	182
				<b>Keyboard Platform K</b>	203	206

<b>Pulls:</b>	Antique Brass <b>A</b>	Ebony <b>E</b>	Silver <b>W</b>
---------------	------------------------	----------------	-----------------

**Bow Front Left Pedestal Desk**



Freight Class: 110

- Two box drawers
- One file drawer, letter or legal filing
- One writing shelf
- Two wire management grommets
- Locking pedestal

V__721LB2BF	72" X 36" X 29"	Cubic Ft: 51.6	Ship Weight: 289	<b>2703</b>	<b>2744</b>	<b>2784</b>
				<b>Center Drawer C</b>	165	167
				<b>Keyboard Platform K</b>	196	199

<b>Pulls:</b>	Antique Brass <b>A</b>	Ebony <b>E</b>	Silver <b>W</b>
---------------	------------------------	----------------	-----------------

**Bow Front Right Pedestal Desk**



Freight Class: 110

- Two box drawers
- One file drawer, letter or legal filing
- One writing shelf
- Two wire management grommets
- Locking pedestal

V__721RB2BF	72" X 36" X 29"	Cubic Ft: 51.6	Ship Weight: 289	<b>2703</b>	<b>2744</b>	<b>2784</b>
				<b>Center Drawer C</b>	165	167
				<b>Keyboard Platform K</b>	196	199

<b>Pulls:</b>	Antique Brass <b>A</b>	Ebony <b>E</b>	Silver <b>W</b>
---------------	------------------------	----------------	-----------------

**Double Pedestal Desk**



Freight Class: 110

- Four box drawers
- Two file drawers, letter or legal filing
- Two writing shelves
- Two wire management grommets
- Individually locking pedestals

V__7202BF	72" X 36" X 29"	Cubic Ft: 51.6	Ship Weight: 370	<b>2708</b>	<b>2749</b>	<b>2789</b>
				<b>Center Drawer C</b>	179	182
				<b>Keyboard Platform K</b>	203	206

V__6602BF	66" X 30" X 29"	Cubic Ft: 40.2	Ship Weight: 330	<b>2465</b>	<b>2502</b>	<b>2539</b>
				<b>Center Drawer C</b>	165	167
				<b>Keyboard Platform K</b>	199	202

<b>Pulls:</b>	Antique Brass <b>A</b>	Ebony <b>E</b>	Silver <b>W</b>
---------------	------------------------	----------------	-----------------

TRANSITIONAL LAMINATE



### Left Pedestal Desk



- Two box drawers
- One file drawer, letter or legal filing
- One writing shelf
- Two wire management grommets
- Locking pedestal

Freight Class: 110

### Right Pedestal Desk



- Two box drawers
- One file drawer, letter or legal filing
- One writing shelf
- Two wire management grommets
- Locking pedestal

Freight Class: 110

### 3/4 Double Pedestal Bow Front Desk

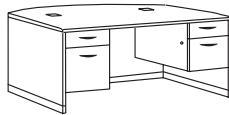

- Two box drawers
- Two file drawers, letter or legal filing
- Two wire management grommets
- Individually locking pedestals

Freight Class: 110

### 3/4 Left Pedestal Bow Front Desk

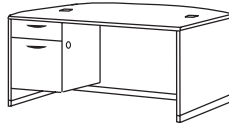

- One box drawer
- One file drawer, letter or legal filing
- Two wire management grommets
- Locking pedestal

Freight Class: 200

### 3/4 Right Pedestal Bow Front Desk

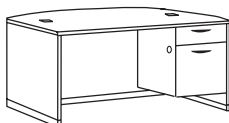

- One box drawer
- One file drawer, letter or legal filing
- Two wire management grommets
- Locking pedestal

Freight Class: 200

### 3/4 Double Pedestal Desk



- Two box drawers
- Two file drawers, letter or legal filing
- Two wire management grommets
- Individually locking pedestals

Freight Class: 110

### 3/4 Left Pedestal Desk

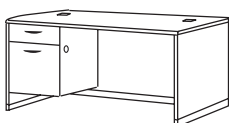

- One box drawer
- One file drawer, letter or legal filing
- Two wire management grommets
- Locking pedestals
- Connect with return or bridge/credenza

Freight Class: 200

	Zone Pricing	1	2	3
<b>V__721L2BF</b> 72" X 36" X 29" Cubic Ft: 51.6 Ship Weight: 298		<b>2343</b>	<b>2378</b>	<b>2413</b>
	<b>Center Drawer C</b>	165	167	170
	<b>Keyboard Platform K</b>	196	199	202
<b>V__651L2BF</b> 66" X 30" X 29" Cubic Ft: 40.2 Ship Weight: 262		<b>2048</b>	<b>2079</b>	<b>2109</b>
	<b>Center Drawer C</b>	165	167	170
	<b>Keyboard Platform K</b>	196	199	202
<b>Pulls:</b> Antique Brass <b>A</b> Ebony <b>E</b> Silver <b>W</b>				
<b>V__721R2BF</b> 72" X 36" X 29" Cubic Ft: 51.6 Ship Weight: 298		<b>2343</b>	<b>2378</b>	<b>2413</b>
	<b>Center Drawer C</b>	165	167	170
	<b>Keyboard Platform K</b>	196	199	202
<b>V__651R2BF</b> 66" X 30" X 29" Cubic Ft: 40.2 Ship Weight: 262		<b>2048</b>	<b>2079</b>	<b>2109</b>
	<b>Center Drawer C</b>	165	167	170
	<b>Keyboard Platform K</b>	196	199	202
<b>Pulls:</b> Antique Brass <b>A</b> Ebony <b>E</b> Silver <b>W</b>				
<b>V__720B</b> 72" X 36" X 29" Cubic Ft: 51.6 Ship Weight: 298		<b>2447</b>	<b>2484</b>	<b>2520</b>
	<b>Center Drawer C</b>	179	182	184
	<b>Keyboard Platform K</b>	203	206	209
<b>Pulls:</b> Antique Brass <b>A</b> Ebony <b>E</b> Silver <b>W</b>				
<b>V__721LB</b> 72" X 36" X 29" Cubic Ft: 51.6 Ship Weight: 250		<b>2102</b>	<b>2134</b>	<b>2165</b>
	<b>Center Drawer C</b>	165	167	170
	<b>Keyboard Platform K</b>	196	199	202
<b>Pulls:</b> Antique Brass <b>A</b> Ebony <b>E</b> Silver <b>W</b>				
<b>V__721RB</b> 72" X 36" X 29" Cubic Ft: 51.6 Ship Weight: 250		<b>2102</b>	<b>2134</b>	<b>2165</b>
	<b>Center Drawer C</b>	165	167	170
	<b>Keyboard Platform K</b>	196	199	202
<b>Pulls:</b> Antique Brass <b>A</b> Ebony <b>E</b> Silver <b>W</b>				
<b>V__720</b> 72" X 36" X 29" Cubic Ft: 51.6 Ship Weight: 298		<b>2158</b>	<b>2190</b>	<b>2223</b>
	<b>Center Drawer C</b>	179	182	184
	<b>Keyboard Platform K</b>	203	206	209
<b>V__660</b> 66" X 30" X 29" Cubic Ft: 40.2 Ship Weight: 259		<b>1963</b>	<b>1992</b>	<b>2022</b>
	<b>Center Drawer C</b>	179	182	184
	<b>Keyboard Platform K</b>	199	202	205
<b>Pulls:</b> Antique Brass <b>A</b> Ebony <b>E</b> Silver <b>W</b>				
<b>V__721L</b> 72" X 36" X 29" Cubic Ft: 51.6 Ship Weight: 250		<b>1848</b>	<b>1876</b>	<b>1903</b>
	<b>Center Drawer C</b>	165	167	170
	<b>Keyboard Platform K</b>	196	199	202
<b>V__651L</b> 66" X 30" X 29" Cubic Ft: 40.2 Ship Weight: 220		<b>1744</b>	<b>1770</b>	<b>1796</b>
	<b>Center Drawer C</b>	165	167	170
	<b>Keyboard Platform K</b>	196	199	202
<b>Pulls:</b> Antique Brass <b>A</b> Ebony <b>E</b> Silver <b>W</b>				

Zone Pricing	1	2	3
--------------	---	---	---

**3/4 Right Pedestal Desk**

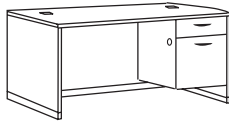

- One box drawer
- One file drawer, letter or legal filing
- Two wire management grommets
- Locking pedestal
- Connect with return or bridge/credenza

Freight Class: 200

<b>V_721R</b>	72" X 36" X 29"	Cubic Ft: 51.6	Ship Weight: 250	<b>1848</b>	<b>1876</b>	<b>1903</b>
				<b>Center Drawer C</b>	165	167
				<b>Keyboard Platform K</b>	196	202
<b>V_651R</b>	66" X 30" X 29"	Cubic Ft: 40.2	Ship Weight: 220	<b>1744</b>	<b>1770</b>	<b>1796</b>
				<b>Center Drawer C</b>	165	167
				<b>Keyboard Platform K</b>	196	202

<b>Pulls:</b>	Antique Brass <b>A</b>	Ebony <b>E</b>	Silver <b>W</b>
---------------	------------------------	----------------	-----------------

**Peninsula Desk**

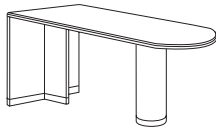

- End support panel
- Cylinder base matches top finish
- Use with returns, bridge/credenza or open leg computer tables

Freight Class: 125

<b>V_799</b>	72" X 36" X 29"	Cubic Ft: 51.6	Ship Weight: 166	<b>1861</b>	<b>1889</b>	<b>1917</b>
--------------	-----------------	----------------	------------------	-------------	-------------	-------------

**Credenzas**

**Full Pedestal Computer Credenza**

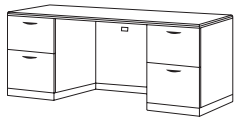

- Four file drawers, letter or legal filing
- One wire management grommet
- Individual locking pedestals

Freight Class: 110

<b>V_704F</b>	72" X 24" X 29"	Cubic Ft: 35.7	Ship Weight: 279	<b>2394</b>	<b>2430</b>	<b>2466</b>
				<b>Keyboard Platform K</b>	203	209
<b>V_604F</b>	66" X 24" X 29"	Cubic Ft: 32.8	Ship Weight: 270	<b>2246</b>	<b>2280</b>	<b>2313</b>
				<b>Keyboard Platform K</b>	199	205

<b>Pulls:</b>	Antique Brass <b>A</b>	Ebony <b>E</b>	Silver <b>W</b>
---------------	------------------------	----------------	-----------------

**Full Pedestal Storage Credenza**

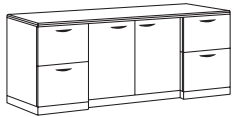

- Four file drawers, letter or legal filing
- Hinged doors with storage compartment in center with one adjustable shelf
- Individually locking pedestals

Freight Class: 125

<b>V_714F</b>	72" X 24" X 29"	Cubic Ft: 35.7	Ship Weight: 333	<b>2864</b>	<b>2907</b>	<b>2950</b>
<b>V_614F</b>	66" X 24" X 29"	Cubic Ft: 32.8	Ship Weight: 300	<b>2710</b>	<b>2751</b>	<b>2791</b>

<b>Pulls:</b>	Antique Brass <b>A</b>	Ebony <b>E</b>	Silver <b>W</b>
---------------	------------------------	----------------	-----------------

**Double Lateral File Credenza**

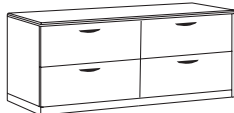

- Four lateral file drawers, letter or legal filing
- Individually locking drawers
- Pre-installed filing hardware

Freight Class: 125

<b>V_733</b>	72" X 24" X 29"	Cubic Ft: 35.7	Ship Weight: 299	<b>2354</b>	<b>2389</b>	<b>2425</b>
--------------	-----------------	----------------	------------------	-------------	-------------	-------------

<b>Pulls:</b>	Antique Brass <b>A</b>	Ebony <b>E</b>	Silver <b>W</b>
---------------	------------------------	----------------	-----------------

**EXTRA THICK BOTTOM** \$320 **H**

**Left Lateral File Credenza**

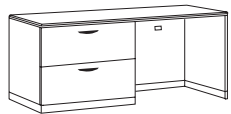

- Two lateral file drawers, letter or legal filing
- One wire management grommet
- Individually locking drawers
- Use with bridge and single pedestal desks

Freight Class: 125

<b>V_733L</b>	72" X 24" X 29"	Cubic Ft: 35.7	Ship Weight: 253	<b>2130</b>	<b>2162</b>	<b>2194</b>
<b>V_633L</b>	66" X 24" X 29"	Cubic Ft: 32.8	Ship Weight: 233	<b>2050</b>	<b>2081</b>	<b>2112</b>

<b>Pulls:</b>	Antique Brass <b>A</b>	Ebony <b>E</b>	Silver <b>W</b>
---------------	------------------------	----------------	-----------------

**EXTRA THICK BOTTOM** \$160 **H**

**Right Lateral File Credenza**

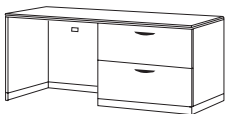

- Two lateral file drawers, letter or legal filing
- One wire management grommet
- Individually locking drawers
- Use with bridge and single pedestal desks

Freight Class: 125

<b>V_733R</b>	72" X 24" X 29"	Cubic Ft: 35.7	Ship Weight: 253	<b>2130</b>	<b>2162</b>	<b>2194</b>
<b>V_633R</b>	66" X 24" X 29"	Cubic Ft: 32.8	Ship Weight: 233	<b>2050</b>	<b>2081</b>	<b>2112</b>

<b>Pulls:</b>	Antique Brass <b>A</b>	Ebony <b>E</b>	Silver <b>W</b>
---------------	------------------------	----------------	-----------------

**EXTRA THICK BOTTOM** \$160 **H**

TRANSITIONAL LAMINATE



### Left Full Pedestal Credenza

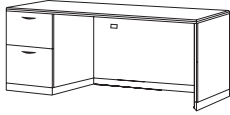

- Two file drawers, letter or legal filing
- One wire management grommet
- Locking pedestal
- Use with bridge and single pedestal desk

Freight Class: 125

### Right Full Pedestal Credenza

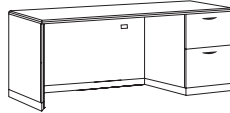

- Two file drawers, letter or legal filing
- One wire management grommet
- Locking pedestal
- Use with bridge and single pedestal desk

Freight Class: 125

### 3/4 Pedestal Computer Credenza

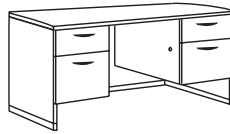

- Two box drawers
- Two file drawers, letter or legal filing
- One wire management grommet
- Individually locking pedestals
- Kneespace 36" wide

Freight Class: 110

### 3/4 Left Pedestal Credenza

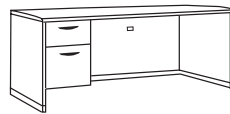

- One box drawer
- One file drawer, letter or legal filing
- One wire management grommet
- Locking pedestal
- Use with bridge and single pedestal desk

Freight Class: 125

### 3/4 Right Pedestal Credenza

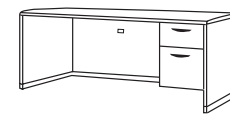

- One box drawer
- One file drawer, letter or legal filing
- One wire management grommet
- Locking pedestal
- Use with bridge and single pedestal desk

Freight Class: 125

## Returns & Bridges

### Full Pedestal Left Return

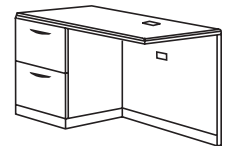

- Two file drawers, letter and legal filing
- One wire management grommet
- Locking pedestal
- Reversed coped edge for smooth work surface connection
- Common grain direction with desk

Freight Class: 110

### Full Pedestal Right Return

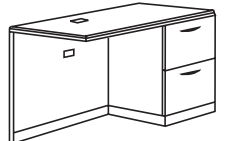

- Two file drawers, letter and legal filing
- One wire management grommet
- Locking pedestal
- Reversed coped edge for smooth work surface connection
- Common grain direction with desk

Freight Class: 110

Zone Pricing

1

2

3

<b>V_725LF</b> 72" X 24" X 29" Cubic Ft: 35.7 Ship Weight: 235	<b>1950</b>	<b>1979</b>	<b>2009</b>
<b>Keyboard Platform K</b>	196	199	202

<b>V_625LF</b> 66" X 24" X 29" Cubic Ft: 32.8 Ship Weight: 195	<b>1851</b>	<b>1879</b>	<b>1907</b>
<b>Keyboard Platform K</b>	196	199	202

<b>Pulls:</b> Antique Brass <b>A</b> Ebony <b>E</b> Silver <b>W</b>
---

<b>V_725RF</b> 72" X 24" X 29" Cubic Ft: 35.7 Ship Weight: 235	<b>1950</b>	<b>1979</b>	<b>2009</b>
<b>Keyboard Platform K</b>	196	199	202

<b>V_625RF</b> 66" X 24" X 29" Cubic Ft: 32.8 Ship Weight: 195	<b>1851</b>	<b>1879</b>	<b>1907</b>
<b>Keyboard Platform K</b>	196	199	202

<b>Pulls:</b> Antique Brass <b>A</b> Ebony <b>E</b> Silver <b>W</b>
---

<b>V_704</b> 72" X 24" X 29" Cubic Ft: 35.7 Ship Weight: 263	<b>2024</b>	<b>2054</b>	<b>2085</b>
<b>Keyboard Platform K</b>	199	202	205

<b>V_604</b> 66" X 24" X 29" Cubic Ft: 32.8 Ship Weight: 240	<b>1888</b>	<b>1916</b>	<b>1945</b>
<b>Keyboard Platform K</b>	199	202	205

<b>Pulls:</b> Antique Brass <b>A</b> Ebony <b>E</b> Silver <b>W</b>
---

<b>V_725L</b> 72" X 24" X 29" Cubic Ft: 35.7 Ship Weight: 175	<b>1750</b>	<b>1776</b>	<b>1803</b>
<b>Keyboard Platform K</b>	196	199	202

<b>V_625L</b> 66" X 24" X 29" Cubic Ft: 32.8 Ship Weight: 160	<b>1625</b>	<b>1649</b>	<b>1674</b>
<b>Keyboard Platform K</b>	196	199	202

<b>Pulls:</b> Antique Brass <b>A</b> Ebony <b>E</b> Silver <b>W</b>
---

<b>V_725R</b> 72" X 24" X 29" Cubic Ft: 35.7 Ship Weight: 175	<b>1750</b>	<b>1776</b>	<b>1803</b>
<b>Keyboard Platform K</b>	196	199	202

<b>V_625R</b> 66" X 24" X 29" Cubic Ft: 32.8 Ship Weight: 160	<b>1625</b>	<b>1649</b>	<b>1674</b>
<b>Keyboard Platform K</b>	196	199	202

<b>Pulls:</b> Antique Brass <b>A</b> Ebony <b>E</b> Silver <b>W</b>
---

<b>V_722LF</b> 48" X 24" X 29" Cubic Ft: 24.3 Ship Weight: 173	<b>1588</b>	<b>1612</b>	<b>1636</b>
<b>Keyboard Platform K</b>	196	199	202

<b>Pulls:</b> Antique Brass <b>A</b> Ebony <b>E</b> Silver <b>W</b>
---

<b>V_722RF</b> 48" X 24" X 29" Cubic Ft: 24.3 Ship Weight: 173	<b>1588</b>	<b>1612</b>	<b>1636</b>
<b>Keyboard Platform K</b>	196	199	202

<b>Pulls:</b> Antique Brass <b>A</b> Ebony <b>E</b> Silver <b>W</b>
---

Zone Pricing	1	2	3
--------------	---	---	---

**Desk Height 3/4 Pedestal Left Return**

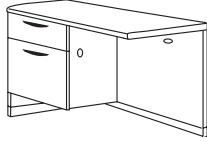

Freight Class: 110

- One box drawer
- One file drawer, letter and legal filing
- One wire management grommet
- Locking pedestal
- Reversed coped edge for smooth work surface connection
- Common grain direction with desk
- Use with computer corner unit, single pedestal desks or credenza

<b>V_722L</b>	48" X 24" X 29"	Cubic Ft: 23.5	Ship Weight: 159	<b>1277</b>	<b>1296</b>	<b>1315</b>
				<b>Keyboard Platform K</b>	196	202

<b>Pulls:</b>	Antique Brass <b>A</b>	Ebony <b>E</b>	Silver <b>W</b>
---------------	------------------------	----------------	-----------------

**Desk Height 3/4 Pedestal Right Return**

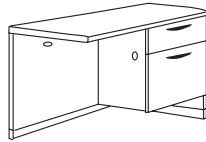

Freight Class: 110

- One box drawer
- One file drawer, letter and legal filing
- One wire management grommet
- Locking pedestal
- Reversed coped edge for smooth work surface connection
- Common grain direction with desk
- Use with computer corner unit, single pedestal desks or credenza

<b>V_722R</b>	48" X 24" X 29"	Cubic Ft: 23.5	Ship Weight: 159	<b>1277</b>	<b>1296</b>	<b>1315</b>
				<b>Keyboard Platform K</b>	196	202

<b>Pulls:</b>	Antique Brass <b>A</b>	Ebony <b>E</b>	Silver <b>W</b>
---------------	------------------------	----------------	-----------------

**Desk Height Bridge**



Freight Class: 110

- Top has reversed edge detail for a solid, smooth work surface connection
- Common grain direction with desk/credenza
- Two wire management grommets in modesty panel

<b>V_485</b>	48" X 24" X 29"	Cubic Ft: 4	Ship Weight: 80	<b>790</b>	<b>802</b>	<b>814</b>
--------------	-----------------	-------------	-----------------	------------	------------	------------

**Computer Corners & Tables**

**Computer Corner Unit**

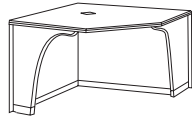

Freight Class: 200

- Open leg support panels
- Three wire management grommets
- Use with computer tables, returns and bridges (24" connection)
- 22" pullup front

<b>V_449</b>	42" X 42" X 29"	Cubic Ft: 34.3	Ship Weight: 173	<b>1197</b>	<b>1215</b>	<b>1233</b>
				<b>Keyboard Platform K</b>	196	202

**Left Computer Table Return**

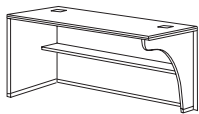

Freight Class: 200

- Open leg panel
- One adjustable shelf
- Two wire management grommets in modesty
- Use with computer corner units, desks, and peninsulas

<b>V_CT48L</b>	48" X 24" X 29"	Cubic Ft: 24.3	Ship Weight: 125	<b>934</b>	<b>948</b>	<b>962</b>
				<b>Keyboard Platform K</b>	203	209

**Right Computer Table Return**

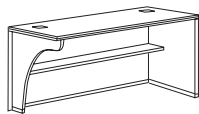

Freight Class: 200

- Open leg panel
- One adjustable shelf
- Two wire management grommets in modesty
- Use with computer corner units, desks, and peninsulas

<b>V_CT48R</b>	48" X 24" X 29"	Cubic Ft: 24.3	Ship Weight: 125	<b>934</b>	<b>948</b>	<b>962</b>
				<b>Keyboard Platform K</b>	203	209

**Computer Table**



Freight Class: 110

- One adjustable shelf
- Four wire management grommets

<b>V_CT48</b>	48" X 24" X 29"	Cubic Ft: 24.3	Ship Weight: 135	<b>942</b>	<b>956</b>	<b>970</b>
				<b>Keyboard Platform K</b>	203	209
<b>V_CT36</b>	36" X 24" X 29"	Cubic Ft: 18.8	Ship Weight: 120	<b>883</b>	<b>896</b>	<b>909</b>
				<b>Keyboard Platform K</b>	199	205

TRANSITIONAL LAMINATE



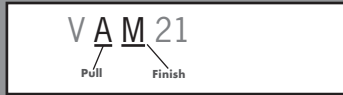

## Files, Bookcases, Storage & Reception Screens

Zone Pricing	1	2	3
--------------	---	---	---

### Mobile Pedestal



- One box drawer
- One file drawer, letter or legal filing
- Fully locking pedestal
- Dual wheel locking casters
- Top mounted pull for easy mobility

Freight Class: 100

<b>V_21</b>	16" X 22" X 22"	Cubic Ft: 6	Ship Weight: 87	<b>719</b>	<b>730</b>	<b>741</b>
-------------	-----------------	-------------	-----------------	------------	------------	------------

<b>Pulls:</b>	Antique Brass <b>A</b>	Ebony <b>E</b>	Silver <b>W</b>
---------------	------------------------	----------------	-----------------

### Standard Lateral File

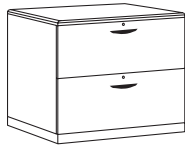

- Two lateral file drawers, letter or legal filing
- Individually locking drawers
- Anti-tilt mechanism inhibits more than one drawer opening at a time
- Hardwood bottom support rail secured with metal bracket at each end

Freight Class: 100

<b>V_326</b>	30" X 20" X 29"	Cubic Ft: 14	Ship Weight: 140	<b>1504</b>	<b>1527</b>	<b>1549</b>
--------------	-----------------	--------------	------------------	-------------	-------------	-------------

<b>Pulls:</b>	Antique Brass <b>A</b>	Ebony <b>E</b>	Silver <b>W</b>
---------------	------------------------	----------------	-----------------

<b>EXTRA THICK BOTTOM</b>	<b>\$160 H</b>
---------------------------	----------------

### Executive Lateral File



- Two lateral file drawers, letter or legal filing
- Individually locking drawers
- Anti-tilt counter weight
- Hardwood bottom support rail secured with metal bracket at each end

Freight Class: 100

<b>V_346</b>	36" X 24" X 29"	Cubic Ft: 18.8	Ship Weight: 197	<b>1652</b>	<b>1677</b>	<b>1702</b>
--------------	-----------------	----------------	------------------	-------------	-------------	-------------

<b>Pulls:</b>	Antique Brass <b>A</b>	Ebony <b>E</b>	Silver <b>W</b>
---------------	------------------------	----------------	-----------------

<b>EXTRA THICK BOTTOM</b>	<b>\$160 H</b>
---------------------------	----------------

### Three Drawer Lateral File

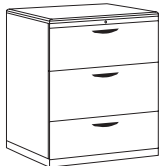

- Three lateral file drawers, letter or legal filing
- Central locking
- Anti-tilt mechanism inhibits more than one drawer opening at a time
- Hardwood bottom support rail secured with metal bracket at each end

Freight Class: 100

<b>V_336</b>	32" X 21" X 44.5"	Cubic Ft: 27.9	Ship Weight: 208	<b>2037</b>	<b>2068</b>	<b>2098</b>
--------------	-------------------	----------------	------------------	-------------	-------------	-------------

<b>Pulls:</b>	Antique Brass <b>A</b>	Ebony <b>E</b>	Silver <b>W</b>
---------------	------------------------	----------------	-----------------

<b>EXTRA THICK BOTTOM</b>	<b>\$240 H</b>
---------------------------	----------------

### Four Drawer Lateral File



- Four lateral file drawers, letter or legal filing
- Central locking
- Anti-tilt mechanism inhibits more than one drawer opening at a time
- Hardwood bottom support rail secured with metal bracket at each end

Freight Class: 100

<b>V_426</b>	32" X 21" X 56"	Cubic Ft: 27.9	Ship Weight: 252	<b>2734</b>	<b>2775</b>	<b>2816</b>
--------------	-----------------	----------------	------------------	-------------	-------------	-------------

<b>Pulls:</b>	Antique Brass <b>A</b>	Ebony <b>E</b>	Silver <b>W</b>
---------------	------------------------	----------------	-----------------

<b>EXTRA THICK BOTTOM</b>	<b>\$320 H</b>
---------------------------	----------------

### Three-Shelf Bookcase



- 1" thick shelves
- 48" bookcase= 2 adjustable shelves
- 36" bookcase= 1 adjustable shelf
- 29" bookcase= 1 adjustable shelf

Freight Class: 125

<b>V_129</b>	36" X 18" X 29"	Cubic Ft: 18.5	Ship Weight: 90	<b>699</b>	<b>709</b>	<b>720</b>
--------------	-----------------	----------------	-----------------	------------	------------	------------

<b>V_36</b>	36" X 18" X 36"	Cubic Ft: 18.5	Ship Weight: 90	<b>746</b>	<b>757</b>	<b>768</b>
-------------	-----------------	----------------	-----------------	------------	------------	------------

<b>V_48</b>	36" X 18" X 48"	Cubic Ft: 24.2	Ship Weight: 110	<b>792</b>	<b>804</b>	<b>816</b>
-------------	-----------------	----------------	------------------	------------	------------	------------

TRANSITIONAL LAMINATE

**Five-Shelf Bookcase**

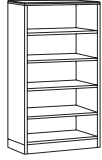

- 1" thick shelves
- Two fixed shelves (middle and bottom)
- 65" & 72" bookcase= 3 adjustable shelves
- 84" bookcase= 4 adjustable shelves

Freight Class: 125

**2-Door Bookcase**



- Two adjustable shelves on top
- One fixed shelf above doors
- Two-door enclosed storage area with one adjustable shelf
- 1" thick shelves

Freight Class: 125

**Overhead Storage Unit with Doors**

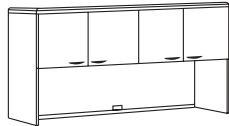

- Two storage compartments
- One wire management grommet
- 21" clearance under doors
- Includes task light standard

Freight Class: 125

**Reception Screen for Main**

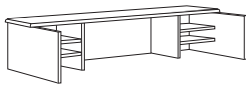

- Fits 66" x 30" desks
- Four adjustable shelves
- High gloss transaction counter top
- Non-skid rubber strips on bottom prohibit movement

Freight Class: 70

**Reception Screen for Return**



- Fits 48" x 24" executive height return
- Hardware included to join to main reception screen
- V\_611L fits left return
- V\_611R fits right return
- Assembly required

Freight Class: 70

**Center Drawers**

**Center Drawer**

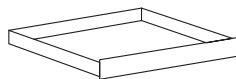

- V\_28- Fits 72" single full pedestal desk or credenza or 66" double full pedestal desk
- V\_29- Fits 72" single 3/4 pedestal desk or credenza
- V\_34- Fits 72" double full pedestal desk or credenza
- V\_38- Fits 72" double 3/4 pedestal desk or credenza

Freight Class: 100

**Center Drawer**

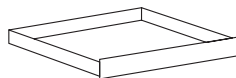

- V\_28- Fits 72" single full pedestal desk or credenza or 66" double full pedestal desk
- V\_32- Fits 66" double 3/4 pedestal desk or credenza
- V\_22- Fits 66" single full pedestal desk or credenza
- V\_24- Fits 66" single 3/4 pedestal desk or credenza

Freight Class: 100

		Zone Pricing	1	2	3
<b>V_65</b>	36" X 18" X 65.5" Cubic Ft: 31.1 Ship Weight: 221		<b>907</b>	<b>921</b>	<b>934</b>
<b>V_72</b>	36" X 18" X 72" Cubic Ft: 35.5 Ship Weight: 241		<b>1026</b>	<b>1041</b>	<b>1057</b>
<b>V_84</b>	36" X 18" X 84" Cubic Ft: 41.3 Ship Weight: 261		<b>1164</b>	<b>1181</b>	<b>1199</b>
<hr/>					
<b>V_652D</b>	36" X 18" X 65.5" Cubic Ft: 31.9 Ship Weight: 230		<b>1200</b>	<b>1218</b>	<b>1236</b>
<b>Pulls:</b> Antique Brass <b>A</b>   Ebony <b>E</b>   Silver <b>W</b>					
<hr/>					
<b>V_737</b>	71" X 18" X 36.5" Cubic Ft: 33.6 Ship Weight: 229		<b>1903</b>	<b>1932</b>	<b>1960</b>
<b>V_677</b>	65" X 18" X 36.5" Cubic Ft: 28.3 Ship Weight: 198		<b>1797</b>	<b>1824</b>	<b>1851</b>
<b>Pulls:</b> Antique Brass <b>A</b>   Ebony <b>E</b>   Silver <b>W</b>					
	<b>Locks</b> \$150.00: <b>Y</b>				
<hr/>					
<b>V_610</b>	66" X 28" X 14" Cubic Ft: 28.9 Ship Weight: 129		<b>1148</b>	<b>1165</b>	<b>1182</b>
<hr/>					
<b>V_611L</b>	48" X 22" X 13" Cubic Ft: 1.5 Ship Weight: 25		<b>257</b>	<b>261</b>	<b>265</b>
<b>V_611R</b>	48" X 22" X 13" Cubic Ft: 1.5 Ship Weight: 25		<b>257</b>	<b>261</b>	<b>265</b>
<hr/>					
<b>V_38</b>	34" X 19" X 3" Cubic Ft: 2.2 Ship Weight: 13.5		<b>179</b>	<b>182</b>	<b>184</b>
<b>V_34</b>	38" X 19" X 3" Cubic Ft: 2.2 Ship Weight: 13		<b>179</b>	<b>182</b>	<b>184</b>
<b>V_29</b>	29.75" X 19" X 3" Cubic Ft: 1.5 Ship Weight: 12		<b>165</b>	<b>167</b>	<b>170</b>
<b>V_28</b>	28" X 19" X 3" Cubic Ft: 1.5 Ship Weight: 11		<b>165</b>	<b>167</b>	<b>170</b>
<hr/>					
<b>V_28</b>	28" X 19" X 3" Cubic Ft: 1.5 Ship Weight: 11		<b>165</b>	<b>167</b>	<b>170</b>
<b>V_32</b>	32" X 19" X 3" Cubic Ft: 2.2 Ship Weight: 12.2		<b>179</b>	<b>182</b>	<b>184</b>
<b>V_22</b>	22.5" X 19" X 3" Cubic Ft: 1.5 Ship Weight: 10		<b>165</b>	<b>167</b>	<b>170</b>
<b>V_24</b>	23.75" X 19" X 3" Cubic Ft: 1.5 Ship Weight: 10.5		<b>165</b>	<b>167</b>	<b>170</b>

TRANSITIONAL LAMINATE



### FINISHES:

– ALL COLORS ARE THE SAME PRICE – All finishes are thermally fused laminates unless otherwise noted. **A high pressure laminate top option is available for a 15% pricing upcharge. A six-week lead time will apply.** High-pressure laminate tops are only offered in Windsor Cherry, Mahogany and Grey. Contact your customer service representative to discuss specific high pressure laminate needs and delivery quotes. To order high-pressure laminate tops on Elevation items with 1" thick tops in **Windsor Cherry, Mahogany or Grey**, add a **4** after the first **E** in the model number and add 15% to the list price of the item. **Example: E4WWC720**

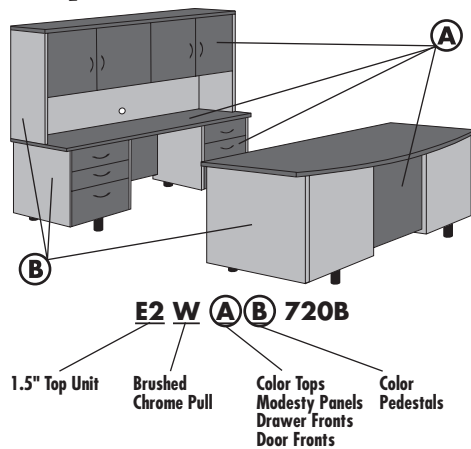

### FINISH COLORS

- |                         |                          |
|-------------------------|--------------------------|
| <b>AP</b> Aspen         | <b>PW</b> Pearwood       |
| <b>E</b> Black          | <b>WC</b> Windsor Cherry |
| <b>FM</b> Natural Maple | <b>G</b> Grey            |
| <b>GP</b> Graphite      | <b>X</b> Espresso        |
| <b>M</b> Mahogany       | <b>CC</b> Classic Cherry |
| <b>O</b> Medium Oak     |                          |

	Location	Finishes
<b>E2</b>	1.5" Tops, Modesty Panels, Drawer and Door Fronts	<b>FM</b> Natural Maple <b>WC</b> Windsor Cherry <b>AP</b> Aspen <b>M</b> Mahogany
<b>E</b>	1" Tops, Modesty Panels, Drawer and Door Fronts	All Colors
	Pedestals	All Colors

### PULL OPTIONS

All pulls constructed of solid metal and feature curvilinear design. When ordering, use the corresponding pull designator at the beginning of the model number.

- |                          |                           |
|--------------------------|---------------------------|
| <b>1" TOP</b>            | <b>1.5" TOP</b>           |
| <b>EW</b> Brushed Chrome | <b>E2W</b> Brushed Chrome |
| <b>EE</b> Ebony          | <b>E2E</b> Ebony          |
| <b>EB</b> Bright Brass   | <b>E2B</b> Bright Brass   |
| <b>ED</b> Oval Nickel    | <b>E2D</b> Oval Nickel    |

### PEDESTALS

All cases are 3/4" thick core with thermally fused laminate on both sides with 3mm PVC AdvantEdge banding. Drawer pedestals feature box/box/file configuration. Left/right desks and credenzas specified for L and U configurations feature an open storage pedestal (grommets in bottom) in the connecting corner. Pedestal-based construction allows selection of base color to match, complement or contrast the color of worksurface, modesty panel and drawer fronts.

### FILE/FILE PEDESTAL OPTION

File/file pedestal option available at \$21 list upcharge per pedestal. Specify **(F)** after model number. **Example: EWFMGP720F**

### TOPS

Select 1" (**E**) or 1.5" (**E2**) thick tops. All tops feature thermally fused laminate surface with proper backing and smooth full 3mm PVC AdvantEdge banding as required.

**High pressure laminate option available.**

### LEGS

Raised-platform style achieved with 2.25" diameter steel legs with black powdercoat finish. Legs are 3.5" high with 1" heavy-duty leveler on bottom, allowing quick, easy adjustment.

### MODESTY PANELS

Modesty panels are 3/4" thick core with thermally fused laminate on both sides and full 3mm PVC AdvantEdge banding as required.

### DRAWERS

- All drawers suspended on smooth action steel, ball-bearing slides
- File and lateral file drawers mounted on heavy-duty, ball-bearing, full-extension slides
- All file and lateral file drawers constructed for suspended filing with 25 lb maximum weight for bottom loading
- Black filing hardware includes pre-installed rails with easy-adjust crossbar
- All file drawers accommodate letter-size filing front-to-back and letter- or legal-size filing side-to-side
- Lateral file drawers accommodate letter or legal size filing front-to-back or side-to-side
- Drawers constructed with 5 sides for extra strength and durability. Drawer front is the fifth side and is removable for field-repair or hardware additions

### FILING

All file drawers include pre-installed, black filing hardware, easily reconfigured by user to adapt to specific requirements.

### WIRE MANAGEMENT

See features for number of grommets and location. Additional grommets can be added for extended wire management capability at \$106 list per grommet. Includes factory cut and installed grommet

and black sleeve. Call for special quote. Specify location and quote number with order.

### LOCKS

- All other locks are keyed identical, except four-drawer vertical file, unless otherwise specified
- 'Key Different' option is \$21 list upcharge per lock. Locks/cores packaged to customer requirements
- Additional lead time for 'Key Different'
- For optional locking on overhead storage units with four wood doors, add **Y** to the end of the model number and add \$150 to the list price of unit

### ACCESSORY WALL

For flexible and personalized work areas, Accessory Wall and coordinating storage accessories are available for mounting on overhead units (see pages 185-187). All components made of black resin. Field installed.

### ACCESSORIES *Factory Installed*

Certain accessories can be ordered installed prior to shipment. Add letter designator (C or K) at end of the desk or credenza model number:

- C** Center Drawer  
*Example: E2WWC720C*
- K** Keyboard Platform  
*Example: EWWC704K*
- T** Task Light  
*Example: EWWC737T*

### QUICKSHIP

Quick Ship is not available on any items ordered with option.

### PACKING

All units are properly packed in heavy-duty cartons, protected with extra-thick corner pads, and foam-wrapped for additional security. All packaging conforms to or exceeds specifications as outlined in the Uniform Freight Classification.

All desks, credenzas, files and overhead storage units are shipped set up. Modular L, U, and reception stations are shipped in multiple cartons and require field connection.

### PALLETIZATION

See page 3.

### CARE AND CLEANING INSTRUCTIONS

**Normal cleaning:** Clean using a soft cloth and a good window cleaner which contains no ammonia, followed by wiping dry using a dry soft cloth.

**Specifications subject to change without notice.**

ALL PEDESTALS & 1" TOPS FINISHES (E)  
 ASPEN **AP** | BLACK **E** | NATURAL MAPLE **FM** | PEARWOOD **PW** |  
 GRAPHITE **GP** | MAHOGANY **M** | MEDIUM OAK **O** | ESPRESSO **X** |  
 WINDSOR CHERRY **WC** | GREY **G** | CLASSIC CHERRY **CC** |

1.5" TOPS FINISHES (E2)  
 NATURAL MAPLE **FM** | ASPEN **AP** |  
 WINDSOR CHERRY **WC** |  
 MAHOGANY **M** |

SIN 711-2

# ELEVATION

## Configurations

Zone Pricing

1

2

3

### Executive L Unit (1" Tops)

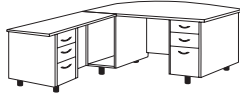

Description	Model Number	Qty	Frft. Class	Cubic Ft.	Ship Weight				
Right Bow Front Desk	E_721RB 72" x 36" x 29"	1	200	44.5	237	<b>1528</b>	<b>1551</b>	<b>1574</b>	
Left Return	E_722L 48" x 24" x 29"	1	110	20.7	160	<b>984</b>	<b>999</b>	<b>1014</b>	
Total:					65.20	397	<b>2512</b>	<b>2550</b>	<b>2588</b>

72" x 84" x 29"

### Executive U Unit (1" Tops)



Description	Model Number	Qty	Frft. Class	Cubic Ft.	Ship Weight				
Right Pedestal Desk	E_721R 72" x 36" x 29"	1	110	44.5	247	<b>1341</b>	<b>1361</b>	<b>1381</b>	
Left Pedestal Credenza	E_725L 72" x 24" x 29"	1	125	30.6	200	<b>1205</b>	<b>1223</b>	<b>1241</b>	
Bridge	E_485 48" x 24" x 29"	1	100	4.0	62	<b>399</b>	<b>405</b>	<b>411</b>	
Overhead with Doors	E_737 72" x 16" x 36.5"	1	125	33.6	205	<b>1192</b>	<b>1210</b>	<b>1228</b>	
Total:					112.70	714	<b>4137</b>	<b>4199</b>	<b>4261</b>

72" x 108" x 65.5"

### Executive Office (1" Tops)

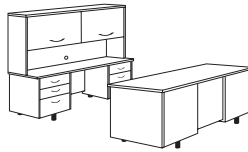

Description	Model Number	Qty	Frft. Class	Cubic Ft.	Ship Weight				
Double Pedestal Desk	E_720 72" x 36" x 29"	1	110	44.5	283	<b>1653</b>	<b>1678</b>	<b>1703</b>	
Computer Credenza	E_704 72" x 24" x 29"	1	110	30.6	228	<b>1498</b>	<b>1520</b>	<b>1543</b>	
Overhead with Flip Up Doors	E_737F 72" x 16" x 36.5"	1	125	33.6	190	<b>1192</b>	<b>1210</b>	<b>1228</b>	
Total:					108.70	701	<b>4343</b>	<b>4408</b>	<b>4474</b>

72" W x 65.5"H

### Executive L Unit (1.5" Tops)

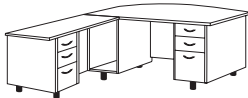

Description	Model Number	Qty	Frft. Class	Cubic Ft.	Ship Weight				
Right Bow Front Desk	E2_721RB 72" x 36" x 29.5"	1	110	45.0	267	<b>1685</b>	<b>1710</b>	<b>1736</b>	
Left Return	E2_722L 48" x 24" x 29.5"	1	110	21.0	178	<b>1078</b>	<b>1094</b>	<b>1110</b>	
Total:					66.00	445	<b>2763</b>	<b>2804</b>	<b>2846</b>

72" x 84" x 29.5"

### Executive U Unit (1.5" Tops)

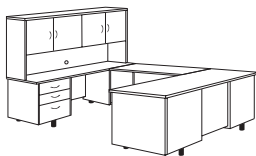

Description	Model Number	Qty	Frft. Class	Cubic Ft.	Ship Weight				
Right Pedestal Desk	E2_721R 72" x 36" x 29.5"	1	110	45.0	287	<b>1498</b>	<b>1520</b>	<b>1543</b>	
Left Pedestal Credenza	E2_725L 72" x 24" x 29.5"	1	125	31.2	226	<b>1331</b>	<b>1351</b>	<b>1371</b>	
Bridge	E2_485 48" x 24" x 29.5"	1	100	4.6	80	<b>493</b>	<b>500</b>	<b>508</b>	
Overhead with Doors	E2_737 72" x 16" x 37"	1	125	33.6	199	<b>1367</b>	<b>1388</b>	<b>1408</b>	
Total:					114.40	792	<b>4689</b>	<b>4759</b>	<b>4830</b>

72" x 108" x 66.5"

CONTEMPORARY LAMINATE



E2 **W** FM 720  
 Pull Finish

### Executive Office (1.5" Tops)



Description	Model Number	Qty	Frt. Class	Cubic Ft.	Ship Weight	Zone Pricing		
						1	2	3
Double Pedestal Desk	E2_720 72" x 36" x 29.5"	1	110	45.0	320	<b>1809</b>	<b>1836</b>	<b>1863</b>
Computer Credenza	E2_704 72" x 24" x 29.5"	1	110	31.2	260	<b>1623</b>	<b>1647</b>	<b>1672</b>
Overhead with Flip Up Doors	E2_737F 72" x 16" x 37"	1	125	33.6	208	<b>1367</b>	<b>1388</b>	<b>1408</b>
Total:						<b>4799</b>	<b>4871</b>	<b>4943</b>

72" W x 66.5"H

## Desks

### Bow Front Double Pedestal Desk



- Bow front top
- Box/Box/File pedestals
- Letter or legal filing
- Pre-installed black filing hardware
- Individually locking pedestals

<b>E_720B</b>	72" X 36" X 29"	Cubic Ft: 44.5	Ship Weight: 263	<b>1840</b>	<b>1868</b>	<b>1895</b>
	<b>Center Drawer C</b>			177	180	182
	<b>Keyboard Platform K</b>			203	206	209
<b>E2_720B</b>	72" X 36" X 29.5"	Cubic Ft: 45	Ship Weight: 300	<b>1996</b>	<b>2026</b>	<b>2056</b>
	<b>Center Drawer C</b>			177	180	182
	<b>Keyboard Platform K</b>			203	206	209

Freight Class: 110

<b>Pulls:</b>	BRUSHED CHROME <b>EW</b>	EBONY <b>EE</b>	BRIGHT BRASS <b>EB</b>	OVAL NICKEL <b>ED</b>
---------------	--------------------------	-----------------	------------------------	-----------------------

### Bow Front Single Pedestal Desk



Bow Front Left Desk (LB)



Bow Front Right Desk (RB)

- Bow Front top
- Box/Box/File pedestal with lock
- Open storage pedestal with grommets (bottom)

- Letter or legal filing
- Pre-installed black filing hardware

<b>E_721LB</b>	72" X 36" X 29"	Cubic Ft: 44.5	Ship Weight: 237	<b>1528</b>	<b>1551</b>	<b>1574</b>
Freight Class: 200	<b>Center Drawer C</b>			165	167	170
	<b>Keyboard Platform K</b>			196	199	202
<b>E_721RB</b>	72" X 36" X 29"	Cubic Ft: 44.5	Ship Weight: 237	<b>1528</b>	<b>1551</b>	<b>1574</b>
Freight Class: 200	<b>Center Drawer C</b>			165	167	170
	<b>Keyboard Platform K</b>			196	199	202
<b>E2_721LB</b>	72" X 36" X 29.5"	Cubic Ft: 45	Ship Weight: 267	<b>1685</b>	<b>1710</b>	<b>1736</b>
Freight Class: 110	<b>Center Drawer C</b>			165	167	170
	<b>Keyboard Platform K</b>			196	199	202
<b>E2_721RB</b>	72" X 36" X 29.5"	Cubic Ft: 45	Ship Weight: 267	<b>1685</b>	<b>1710</b>	<b>1736</b>
Freight Class: 110	<b>Center Drawer C</b>			165	167	170
	<b>Keyboard Platform K</b>			196	199	202

<b>Pulls:</b>	BRUSHED CHROME <b>EW</b>	EBONY <b>EE</b>	BRIGHT BRASS <b>EB</b>	OVAL NICKEL <b>ED</b>
---------------	--------------------------	-----------------	------------------------	-----------------------

UNIT	KNEESPACE	OVERHANG
72" x 36" Double Pedestal Desk	38-1/4"	8-1/4"
72" x 30" Double Pedestal Desk	38-1/4"	2-1/4"
66" x 30" Double Pedestal Desk	32-1/4"	2-1/4"

UNIT	KNEESPACE	OVERHANG
72" Double Pedestal Credenza	38-1/4"	n/a
66" Double Pedestal Credenza	32-1/4"	n/a



ALL PEDESTALS & 1" TOPS FINISHES (E)  
 ASPEN **AP** | BLACK **E** | NATURAL MAPLE **FM** | PEARWOOD **PW** |  
 GRAPHITE **GP** | MAHOGANY **M** | MEDIUM OAK **O** | ESPRESSO **X** |  
 WINDSOR CHERRY **WC** | GREY **G** | CLASSIC CHERRY **CC** |

1.5" TOPS FINISHES (E2)  
 NATURAL MAPLE **FM** | ASPEN **AP** |  
 WINDSOR CHERRY **WC** |  
 MAHOGANY **M** |

SIN 711-2

# ELEVATION

## Double Pedestal Desk



- Box/Box/File pedestal with lock
- Letter or legal filing
- Pre-installed black filing hardware

				Zone Pricing	1	2	3
<b>E__720</b>	72" X 36" X 29"	Cubic Ft: 44.5	Ship Weight: 283		<b>1653</b>	<b>1678</b>	<b>1703</b>
				<b>Center Drawer C</b>	177	180	182
				<b>Keyboard Platform K</b>	203	206	209
<b>E__700</b>	72" X 30" X 29"	Cubic Ft: 40	Ship Weight: 260		<b>1623</b>	<b>1647</b>	<b>1672</b>
				<b>Center Drawer C</b>	177	180	182
				<b>Keyboard Platform K</b>	203	206	209
<b>E__660</b>	66" X 30" X 29"	Cubic Ft: 34.5	Ship Weight: 236		<b>1591</b>	<b>1615</b>	<b>1639</b>
				<b>Center Drawer C</b>	177	180	182
				<b>Keyboard Platform K</b>	203	206	209
<b>E__600</b>	60" X 30" X 29"	Cubic Ft: 32.5	Ship Weight: 220		<b>1465</b>	<b>1487</b>	<b>1509</b>
				<b>Center Drawer C</b>	165	167	170
				<b>Keyboard Platform K</b>	196	199	202
<b>E2__720</b>	72" X 30" X 29.5"	Cubic Ft: 45	Ship Weight: 320		<b>1809</b>	<b>1836</b>	<b>1863</b>
				<b>Center Drawer C</b>	177	180	182
				<b>Keyboard Platform K</b>	203	206	209
<b>E2__700</b>	72" X 30" X 29.5"	Cubic Ft: 40	Ship Weight: 286		<b>1778</b>	<b>1805</b>	<b>1831</b>
				<b>Center Drawer C</b>	177	180	182
				<b>Keyboard Platform K</b>	203	206	209
<b>E2__660</b>	66" X 30" X 29.5"	Cubic Ft: 35.1	Ship Weight: 266		<b>1748</b>	<b>1774</b>	<b>1800</b>
				<b>Center Drawer C</b>	177	180	182
				<b>Keyboard Platform K</b>	203	206	209
<b>E2__600</b>	60" X 30" X 29.5"	Cubic Ft: 33.3	Ship Weight: 250		<b>1614</b>	<b>1638</b>	<b>1662</b>
				<b>Center Drawer C</b>	165	167	170
				<b>Keyboard Platform K</b>	196	199	202
<b>Pulls:</b>				BRUSHED CHROME <b>EW</b>	EBONY <b>EE</b>	BRIGHT BRASS <b>EB</b>	OVAL NICKEL <b>ED</b>

Freight Class: 110

## Single Pedestal Desk



Left Desk (L)



Right Desk (R)

- Box/Box/File pedestal with lock
- Open storage pedestal with grommets (bottom)

- Letter or legal filing
- Pre-installed black filing hardware

<b>E__721L</b>	72" X 36" X 29"	Cubic Ft: 44.5	Ship Weight: 247		<b>1341</b>	<b>1361</b>	<b>1381</b>
				<b>Center Drawer C</b>	165	167	170
				<b>Keyboard Platform K</b>	196	199	202
<b>E__721R</b>	72" X 36" X 29"	Cubic Ft: 44.5	Ship Weight: 247		<b>1341</b>	<b>1361</b>	<b>1381</b>
				<b>Center Drawer C</b>	165	167	170
				<b>Keyboard Platform K</b>	196	199	202
<b>E__700L</b>	72" X 30" X 29"	Cubic Ft: 40	Ship Weight: 224		<b>1316</b>	<b>1336</b>	<b>1355</b>
				<b>Center Drawer C</b>	165	167	170
				<b>Keyboard Platform K</b>	196	246	202
<b>E__700R</b>	72" X 30" X 29"	Cubic Ft: 40	Ship Weight: 224		<b>1316</b>	<b>1336</b>	<b>1355</b>
				<b>Center Drawer C</b>	165	167	170
				<b>Keyboard Platform K</b>	196	199	202
<b>E2__721L</b>	72" X 36" X 29.5"	Cubic Ft: 45	Ship Weight: 287		<b>1498</b>	<b>1520</b>	<b>1543</b>
				<b>Center Drawer C</b>	165	167	170
				<b>Keyboard Platform K</b>	196	199	202
<b>E2__721R</b>	72" X 36" X 29.5"	Cubic Ft: 45	Ship Weight: 287		<b>1498</b>	<b>1520</b>	<b>1543</b>
				<b>Center Drawer C</b>	165	167	170
				<b>Keyboard Platform K</b>	196	199	202
<b>E2__700L</b>	72" X 30" X 29.5"	Cubic Ft: 40	Ship Weight: 240		<b>1473</b>	<b>1495</b>	<b>1517</b>
				<b>Center Drawer C</b>	165	167	170
				<b>Keyboard Platform K</b>	196	199	202
<b>E2__700R</b>	72" X 30" X 29.5"	Cubic Ft: 40	Ship Weight: 240		<b>1473</b>	<b>1495</b>	<b>1517</b>
				<b>Center Drawer C</b>	165	167	170
				<b>Keyboard Platform K</b>	196	199	202
<b>Pulls:</b>				BRUSHED CHROME <b>EW</b>	EBONY <b>EE</b>	BRIGHT BRASS <b>EB</b>	OVAL NICKEL <b>ED</b>

Freight Class: 110

CONTEMPORARY LAMINATE

# ELEVATION SIN 711-2

Edge Profile



How to Order

E W FM 651L	
Pull	Finish

## Single Pedestal Desk



Left Desk (L)

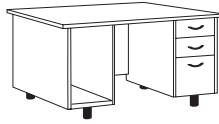

Right Desk (R)

- Box/Box/File pedestal with lock
- Open storage pedestal with grommets (bottom)

- Letter or legal filing
- Pre-installed black filing hardware

Freight Class: 110

## Computer Desk



- Box/Box/File left pedestal with lock
- Letter or legal filing
- Pre-installed black filing hardware
- CPU storage pedestal with door on right
- 270° opening door
- Grommet in top
- Grommets in CPU storage (bottom shelf and inside panel)

Freight Class: 110

## Credenzas

### Computer Credenzas

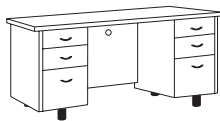

- Box/Box/File pedestals
- Letter or legal filing
- Pre-installed black filing hardware
- Grommet in modesty panel
- Individually locking pedestals

Freight Class: 110

Pulls: BRUSHED CHROME **EW** EBONY **EE** BRIGHT BRASS **EB** OVAL NICKEL **ED**

Zone Pricing	1	2	3
--------------	---	---	---

<b>E__651L</b>	66" X 30" X 29"	Cubic Ft: 34.5	Ship Weight: 200	<b>1279</b>	<b>1298</b>	<b>1317</b>
	<b>Center Drawer C</b>			165	167	170
	<b>Keyboard Platform K</b>			196	199	202
<b>E__651R</b>	66" X 30" X 29"	Cubic Ft: 34.5	Ship Weight: 200	<b>1279</b>	<b>1298</b>	<b>1317</b>
	<b>Center Drawer C</b>			165	167	170
	<b>Keyboard Platform K</b>			196	199	202
<b>E__641L</b>	60" X 30" X 29"	Cubic Ft: 32.5	Ship Weight: 190	<b>1163</b>	<b>1180</b>	<b>1198</b>
	<b>Center Drawer C</b>			165	167	170
	<b>Keyboard Platform K</b>			196	246	202
<b>E__641R</b>	60" X 30" X 29"	Cubic Ft: 32.5	Ship Weight: 190	<b>1163</b>	<b>1180</b>	<b>1198</b>
	<b>Center Drawer C</b>			165	167	170
	<b>Keyboard Platform K</b>			196	199	202
<b>E2__651L</b>	66" X 30" X 29.5"	Cubic Ft: 35.1	Ship Weight: 230	<b>1435</b>	<b>1457</b>	<b>1478</b>
	<b>Center Drawer C</b>			165	167	170
	<b>Keyboard Platform K</b>			196	199	202
<b>E2__651R</b>	66" X 30" X 29.5"	Cubic Ft: 35.1	Ship Weight: 230	<b>1435</b>	<b>1457</b>	<b>1478</b>
	<b>Center Drawer C</b>			165	167	170
	<b>Keyboard Platform K</b>			196	199	202
<b>E2__641L</b>	60" X 30" X 29.5"	Cubic Ft: 33	Ship Weight: 220	<b>1310</b>	<b>1330</b>	<b>1349</b>
	<b>Center Drawer C</b>			165	167	170
	<b>Keyboard Platform K</b>			196	199	202
<b>E2__641R</b>	60" X 30" X 29.5"	Cubic Ft: 33	Ship Weight: 220	<b>1310</b>	<b>1330</b>	<b>1349</b>
	<b>Center Drawer C</b>			165	167	170
	<b>Keyboard Platform K</b>			196	199	202

Pulls: BRUSHED CHROME **EW** EBONY **EE** BRIGHT BRASS **EB** OVAL NICKEL **ED**

<b>E__720CPU</b>	72" X 36" X 29"	Cubic Ft: 44.5	Ship Weight: 283	<b>1653</b>	<b>1678</b>	<b>1703</b>
	<b>Center Drawer C</b>			177	180	182
	<b>Keyboard Platform K</b>			203	206	209
<b>E__700CPU</b>	72" X 30" X 29"	Cubic Ft: 40	Ship Weight: 260	<b>1623</b>	<b>1647</b>	<b>1672</b>
	<b>Center Drawer C</b>			177	180	182
	<b>Keyboard Platform K</b>			203	206	209
<b>E__660CPU</b>	66" X 30" X 29"	Cubic Ft: 34.5	Ship Weight: 236	<b>1591</b>	<b>1615</b>	<b>1639</b>
	<b>Center Drawer C</b>			177	180	182
	<b>Keyboard Platform K</b>			203	206	209
<b>E2__720CPU</b>	72" X 36" X 29.5"	Cubic Ft: 45	Ship Weight: 320	<b>1809</b>	<b>1836</b>	<b>1863</b>
	<b>Center Drawer C</b>			177	180	182
	<b>Keyboard Platform K</b>			203	206	209
<b>E2__700CPU</b>	72" X 30" X 29.5"	Cubic Ft: 40	Ship Weight: 293	<b>1778</b>	<b>1805</b>	<b>1831</b>
	<b>Center Drawer C</b>			177	180	182
	<b>Keyboard Platform K</b>			203	206	209
<b>E2__660CPU</b>	66" X 30" X 29.5"	Cubic Ft: 35.1	Ship Weight: 266	<b>1748</b>	<b>1774</b>	<b>1800</b>
	<b>Center Drawer C</b>			177	180	182
	<b>Keyboard Platform K</b>			203	206	209

Pulls: BRUSHED CHROME **EW** EBONY **EE** BRIGHT BRASS **EB** OVAL NICKEL **ED**

<b>E__704</b>	72" X 24" X 29"	Cubic Ft: 30.6	Ship Weight: 228	<b>1498</b>	<b>1520</b>	<b>1543</b>
	<b>Keyboard Platform K</b>			203	206	209
<b>E__604</b>	66" X 24" X 29"	Cubic Ft: 28.1	Ship Weight: 215	<b>1466</b>	<b>1488</b>	<b>1510</b>
	<b>Keyboard Platform K</b>			203	206	209
<b>E2__704</b>	72" X 24" X 29.5"	Cubic Ft: 31.2	Ship Weight: 260	<b>1623</b>	<b>1647</b>	<b>1672</b>
	<b>Keyboard Platform K</b>			203	206	209
<b>E2__604</b>	66" X 24" X 29.5"	Cubic Ft: 28.6	Ship Weight: 239	<b>1591</b>	<b>1615</b>	<b>1639</b>
	<b>Keyboard Platform K</b>			203	206	209

ALL PEDESTALS & 1" TOPS FINISHES (E)

ASPEN **AP** | BLACK **E** | NATURAL MAPLE **FM** | PEARWOOD **PW** | GRAPHITE **GP** | MAHOGANY **M** | MEDIUM OAK **O** | ESPRESSO **X** | WINDSOR CHERRY **WC** | GREY **G** | CLASSIC CHERRY **CC** |

1.5" TOPS FINISHES (E2)

NATURAL MAPLE **FM** | ASPEN **AP** | WINDSOR CHERRY **WC** | MAHOGANY **M** |

SIN 711-2

# ELEVATION

### Single Pedestal Credenza



Left Credenza (L)

- Box/Box/File pedestal
- Letter or legal filing
- Open storage pedestal on connecting side

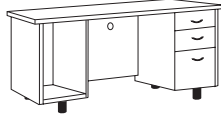

Right Credenza (R)

- Wire management grommets in modesty panel and open storage (bottom)
- Connects desk and credenza

Freight Class: 125

### Single Pedestal Credenza



Left Credenza (L)

- Box/Box/File pedestal with lock
- Letter or legal filing
- Pre-installed black filing hardware

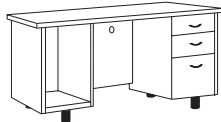

Right Credenza (R)

- Open storage pedestal on connecting side
- Grommets in modesty panel and open storage (bottom)

Freight Class: 125

### Lateral File Credenza



Left Lateral File Credenza (L)

- Two lateral file drawers
- Full extension drawers
- Single-key locking
- Letter or legal filing

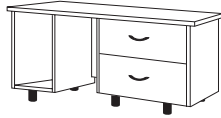

Right Lateral File Credenza (R)

- Pre-installed black filing hardware
- Open storage pedestal on connecting side
- Grommets in open storage (bottom) and modesty panel

Freight Class: 125

### Lateral File Credenza



Left Lateral File Credenza (L)

- Two lateral file drawers
- Full extension drawers
- Single-key locking
- Letter or legal filing



Right Lateral File Credenza (R)

- Pre-installed black filing hardware
- Open storage pedestal on connecting side
- Grommets in open storage (bottom) and modesty panel

Freight Class: 125

## Returns & Bridges

### Desk Height Bridge



- Two wire management grommets in modesty panel
- Requires assembly of top to modesty panel
- Connects with bridge and credenza

Freight Class: 100

Zone Pricing	1	2	3
--------------	---	---	---

<b>E_725L</b>	72" X 24" X 29"	Cubic Ft: 30.6	Ship Weight: 200	<b>1205</b>	<b>1223</b>	<b>1241</b>
				<b>Keyboard Platform K</b>	196	202
<b>E_725R</b>	72" X 24" X 29"	Cubic Ft: 30.6	Ship Weight: 200	<b>1205</b>	<b>1223</b>	<b>1241</b>
				<b>Keyboard Platform K</b>	196	202
<b>E2_725L</b>	72" X 24" X 29.5"	Cubic Ft: 31.2	Ship Weight: 226	<b>1331</b>	<b>1351</b>	<b>1371</b>
				<b>Keyboard Platform K</b>	196	202
<b>E2_725R</b>	72" X 24" X 29.5"	Cubic Ft: 31.2	Ship Weight: 226	<b>1331</b>	<b>1351</b>	<b>1371</b>
				<b>Keyboard Platform K</b>	196	202

<b>Pulls:</b>	BRUSHED CHROME <b>EW</b>	EBONY <b>EE</b>	BRIGHT BRASS <b>EB</b>	OVAL NICKEL <b>ED</b>
---------------	--------------------------	-----------------	------------------------	-----------------------

<b>E_625L</b>	66" X 24" X 29"	Cubic Ft: 28.1	Ship Weight: 179	<b>1169</b>	<b>1187</b>	<b>1204</b>
				<b>Keyboard Platform K</b>	196	202
<b>E_625R</b>	66" X 24" X 29"	Cubic Ft: 28.1	Ship Weight: 179	<b>1169</b>	<b>1187</b>	<b>1204</b>
				<b>Keyboard Platform K</b>	196	202
<b>E2_625L</b>	66" X 24" X 29.5"	Cubic Ft: 28.7	Ship Weight: 203	<b>1293</b>	<b>1312</b>	<b>1332</b>
				<b>Keyboard Platform K</b>	196	202
<b>E2_625R</b>	66" X 24" X 29.5"	Cubic Ft: 28.7	Ship Weight: 203	<b>1293</b>	<b>1312</b>	<b>1332</b>
				<b>Keyboard Platform K</b>	196	202

<b>Pulls:</b>	BRUSHED CHROME <b>EW</b>	EBONY <b>EE</b>	BRIGHT BRASS <b>EB</b>	OVAL NICKEL <b>ED</b>
---------------	--------------------------	-----------------	------------------------	-----------------------

<b>E_733L</b>	72" X 24" X 29"	Cubic Ft: 30.6	Ship Weight: 232	<b>1267</b>	<b>1286</b>	<b>1305</b>
<b>E_733R</b>	72" X 24" X 29"	Cubic Ft: 30.6	Ship Weight: 232	<b>1267</b>	<b>1286</b>	<b>1305</b>
<b>E2_733L</b>	72" X 24" X 29.5"	Cubic Ft: 31.2	Ship Weight: 258	<b>1393</b>	<b>1414</b>	<b>1435</b>
<b>E2_733R</b>	72" X 24" X 29.5"	Cubic Ft: 31.2	Ship Weight: 258	<b>1393</b>	<b>1414</b>	<b>1435</b>

<b>Pulls:</b>	BRUSHED CHROME <b>EW</b>	EBONY <b>EE</b>	BRIGHT BRASS <b>EB</b>	OVAL NICKEL <b>ED</b>
---------------	--------------------------	-----------------	------------------------	-----------------------

**EXTRA THICK BOTTOM** \$160: H

<b>E_633L</b>	66" X 24" X 29"	Cubic Ft: 28.1	Ship Weight: 219	<b>1205</b>	<b>1223</b>	<b>1241</b>
<b>E_633R</b>	66" X 24" X 29"	Cubic Ft: 28.1	Ship Weight: 219	<b>1205</b>	<b>1223</b>	<b>1241</b>
<b>E2_633L</b>	66" X 24" X 29.5"	Cubic Ft: 28.7	Ship Weight: 243	<b>1331</b>	<b>1351</b>	<b>1371</b>
<b>E2_633R</b>	66" X 24" X 29.5"	Cubic Ft: 28.7	Ship Weight: 243	<b>1331</b>	<b>1351</b>	<b>1371</b>

<b>Pulls:</b>	BRUSHED CHROME <b>EW</b>	EBONY <b>EE</b>	BRIGHT BRASS <b>EB</b>	OVAL NICKEL <b>ED</b>
---------------	--------------------------	-----------------	------------------------	-----------------------

**EXTRA THICK BOTTOM** \$160: H

<b>E_485</b>	48" X 24" X 29"	Cubic Ft: 4	Ship Weight: 62	<b>399</b>	<b>405</b>	<b>411</b>
<b>E_484</b>	42" X 24" X 29"	Cubic Ft: 4	Ship Weight: 54	<b>380</b>	<b>386</b>	<b>391</b>
<b>E2_485</b>	48" X 24" X 29.5"	Cubic Ft: 4.6	Ship Weight: 80	<b>493</b>	<b>500</b>	<b>508</b>
<b>E2_484</b>	42" X 24" X 29.5"	Cubic Ft: 4.6	Ship Weight: 69	<b>467</b>	<b>474</b>	<b>481</b>

<b>Pulls:</b>	BRUSHED CHROME <b>EW</b>	EBONY <b>EE</b>	BRIGHT BRASS <b>EB</b>	OVAL NICKEL <b>ED</b>
---------------	--------------------------	-----------------	------------------------	-----------------------

CONTEMPORARY LAMINATE

# ELEVATION SIN 711-2

Edge Profile



How to Order

E W FM 722L  
 Pull Finish

## Desk Height Return

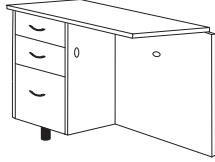

Left Return (L)

- Box/Box/File pedestal
- Letter or legal filing
- Single-key locking



Right Return (R)

- Pre-installed black filing hardware
- One wire management grommet in modesty panel

Freight Class: 110

## Desk Height Return

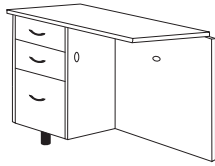

Left Return (L)

- Box/Box/File pedestal
- Letter or legal filing
- Side locking



Right Return (R)

- Pre-installed black filing hardware
- One wire management grommet in modesty panel

Freight Class: 110

## Desk Height Return

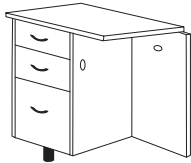

Left Return (L)

- Box/Box/File pedestal
- Letter or legal filing
- Side locking

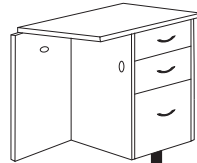

Right Return (R)

- Pre-installed black filing hardware
- One wire management grommet in modesty panel

Freight Class: 110

Zone Pricing	1	2	3
--------------	---	---	---

<b>E_ 722L</b>	48" X 24" X 29"	Cubic Ft: 20.7	Ship Weight: 160	<b>984</b>	<b>999</b>	<b>1014</b>
				<b>Keyboard Platform K</b>	196	202
<b>E_ 722R</b>	48" X 24" X 29"	Cubic Ft: 20.7	Ship Weight: 160	<b>984</b>	<b>999</b>	<b>1014</b>
				<b>Keyboard Platform K</b>	196	202
<b>E2_ 722L</b>	48" X 24" X 29.5"	Cubic Ft: 21	Ship Weight: 178	<b>1078</b>	<b>1094</b>	<b>1110</b>
				<b>Keyboard Platform K</b>	196	202
<b>E2_ 722R</b>	48" X 24" X 29.5"	Cubic Ft: 21	Ship Weight: 178	<b>1078</b>	<b>1094</b>	<b>1110</b>
				<b>Keyboard Platform K</b>	196	202
<b>Pulls:</b>	BRUSHED CHROME <b>EW</b>	EBONY <b>EE</b>	BRIGHT BRASS <b>EB</b>	OVAL NICKEL <b>ED</b>		

<b>E_ 622L</b>	42" X 24" X 29"	Cubic Ft: 18.2	Ship Weight: 143	<b>953</b>	<b>967</b>	<b>982</b>
				<b>Keyboard Platform K</b>	196	202
<b>E_ 622R</b>	42" X 24" X 29"	Cubic Ft: 18.2	Ship Weight: 143	<b>953</b>	<b>967</b>	<b>982</b>
				<b>Keyboard Platform K</b>	196	202
<b>E2_ 622L</b>	42" X 24" X 29.5"	Cubic Ft: 18.5	Ship Weight: 159	<b>1048</b>	<b>1064</b>	<b>1079</b>
				<b>Keyboard Platform K</b>	196	202
<b>E2_ 622R</b>	42" X 24" X 29.5"	Cubic Ft: 18.5	Ship Weight: 159	<b>1048</b>	<b>1064</b>	<b>1079</b>
				<b>Keyboard Platform K</b>	196	202
<b>Pulls:</b>	BRUSHED CHROME <b>EW</b>	EBONY <b>EE</b>	BRIGHT BRASS <b>EB</b>	OVAL NICKEL <b>ED</b>		

<b>E_ 452L</b>	36" X 24" X 29"	Cubic Ft: 18.2	Ship Weight: 126	<b>923</b>	<b>937</b>	<b>951</b>
<b>E_ 452R</b>	36" X 24" X 29"	Cubic Ft: 18.2	Ship Weight: 126	<b>923</b>	<b>937</b>	<b>951</b>
<b>E2_ 452L</b>	36" X 24" X 29.5"	Cubic Ft: 18.5	Ship Weight: 139	<b>1016</b>	<b>1031</b>	<b>1046</b>
<b>E2_ 452R</b>	36" X 24" X 29.5"	Cubic Ft: 18.5	Ship Weight: 139	<b>1016</b>	<b>1031</b>	<b>1046</b>
<b>Pulls:</b>	BRUSHED CHROME <b>EW</b>	EBONY <b>EE</b>	BRIGHT BRASS <b>EB</b>	OVAL NICKEL <b>ED</b>		

## Filing & Storage

### Overhead Storage with Doors

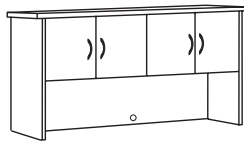

- Two storage compartments
- Four doors
- 21" monitor clearance under cabinet
- Grommet in back panel

<b>E_ 737</b>	72" X 16" X 36.5"	Cubic Ft: 33.6	Ship Weight: 205	<b>1192</b>	<b>1210</b>	<b>1228</b>
				<b>Task Light T</b>	124	128
				<b>LED Task Light L</b>	212	218
<b>E_ 677</b>	66" X 16" X 36.5"	Cubic Ft: 28.3	Ship Weight: 198	<b>945</b>	<b>959</b>	<b>973</b>
				<b>Task Light T</b>	124	128
				<b>LED Task Light L</b>	212	218
<b>E_ 675</b>	60" X 16" X 36.5"	Cubic Ft: 28.3	Ship Weight: 170	<b>939</b>	<b>953</b>	<b>967</b>
				<b>Task Light T</b>	124	128
				<b>LED Task Light L</b>	212	218
<b>E2_ 737</b>	72" X 16" X 37"	Cubic Ft: 33.6	Ship Weight: 199	<b>1367</b>	<b>1388</b>	<b>1408</b>
				<b>Task Light T</b>	124	128
				<b>LED Task Light L</b>	212	218
<b>Pulls:</b>	BRUSHED CHROME <b>EW</b>	EBONY <b>EE</b>	BRIGHT BRASS <b>EB</b>	OVAL NICKEL <b>ED</b>		

Locks \$150: **Y**

Freight Class: 125

CONTEMPORARY LAMINATE

ALL PEDESTALS & 1" TOPS FINISHES (E)  
 ASPEN **AP** | BLACK **E** | NATURAL MAPLE **FM** | PEARWOOD **PW** |  
 GRAPHITE **GP** | MAHOGANY **M** | MEDIUM OAK **O** | ESPRESSO **X** |  
 WINDSOR CHERRY **WC** | GREY **G** | CLASSIC CHERRY **CC** |

1.5" TOPS FINISHES (E2)  
 NATURAL MAPLE **FM** | ASPEN **AP** |  
 WINDSOR CHERRY **WC** |  
 MAHOGANY **M** |

SIN 711-2

# ELEVATION

## Overhead Storage with FlipUp Doors

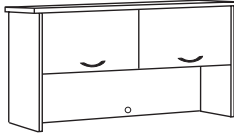

- Two storage compartments
- Two FlipUp doors
- 19" monitor clearance under cabinet
- Grommet in back panel

		Zone Pricing	1	2	3
<b>E_737F</b>	72" X 16" X 36.5" Cubic Ft: 33.6 Ship Weight: 190		<b>1192</b>	<b>1210</b>	<b>1228</b>
	<b>Task Light T</b>		124	126	128
	<b>LED Task Light L</b>		212	215	218
<b>E2_737F</b>	72" X 16" X 37" Cubic Ft: 33.6 Ship Weight: 208		<b>1367</b>	<b>1388</b>	<b>1408</b>
	<b>Task Light T</b>		124	126	128
	<b>LED Task Light L</b>		212	215	218
<b>Pulls:</b> BRUSHED CHROME <b>EW</b>   EBONY <b>EE</b>   BRIGHT BRASS <b>EB</b>   OVAL NICKEL <b>ED</b>					
	<b>Locks</b>		\$150.00:	<b>Y</b>	

Freight Class: 125

## Two-Drawer Lateral File



- Two lateral file drawers, letter or legal filing
- Full extension drawers
- Pre-installed black filing hardware
- Side locking
- Anti-tilt counterweight standard

<b>E_346</b>	38.75" X 24" X 29" Cubic Ft: 16.8 Ship Weight: 165		<b>979</b>	<b>994</b>	<b>1008</b>
<b>E2_346</b>	38.75" X 24" X 29.5" Cubic Ft: 17.3 Ship Weight: 179		<b>1071</b>	<b>1087</b>	<b>1103</b>
<b>Pulls:</b> BRUSHED CHROME <b>EW</b>   EBONY <b>EE</b>   BRIGHT BRASS <b>EB</b>   OVAL NICKEL <b>ED</b>					
	<b>EXTRA THICK BOTTOM</b>		\$160:	<b>H</b>	

Freight Class: 125

## Four-Drawer Lateral File

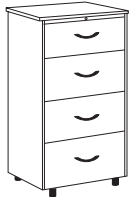

- Four lateral file drawers, letter or legal filing
- Full extension drawers
- Pre-installed black filing hardware
- Front locking
- Anti-tilt counterweight standard

<b>E_426</b>	30.75" X 24" X 60.25" Cubic Ft: 27.9 Ship Weight: 312		<b>2086</b>	<b>2117</b>	<b>2149</b>
<b>E2_426</b>	30.75" X 24" X 60.75" Cubic Ft: 27.9 Ship Weight: 312		<b>2199</b>	<b>2232</b>	<b>2265</b>
<b>Pulls:</b> BRUSHED CHROME <b>EW</b>   EBONY <b>EE</b>   BRIGHT BRASS <b>EB</b>   OVAL NICKEL <b>ED</b>					
	<b>EXTRA THICK BOTTOM</b>		\$320:	<b>H</b>	

Freight Class: 125

## Two-Drawer Vertical File



- Two file drawers, letter or legal filing
- Full extension drawers
- Side locking
- Pre-installed black filing hardware
- Anti-tilt mechanism prevents more than one drawer opening at one time

<b>E_2DF</b>	16" X 24" X 29" Cubic Ft: 11 Ship Weight: 100		<b>818</b>	<b>830</b>	<b>843</b>
<b>E2_2DF</b>	16" X 24" X 29.5" Cubic Ft: 11 Ship Weight: 110		<b>860</b>	<b>873</b>	<b>886</b>
<b>Pulls:</b> BRUSHED CHROME <b>EW</b>   EBONY <b>EE</b>   BRIGHT BRASS <b>EB</b>   OVAL NICKEL <b>ED</b>					

Freight Class: 125

## Four-Drawer Vertical File



- Four file drawers, letter or legal filing
- Full extension drawers
- Center locking (lock on front)
- Pre-installed black filing hardware
- Anti-tilt mechanism prevents more than one drawer opening at one time

<b>E_4DF</b>	16" X 24" X 56.75" Cubic Ft: 14.25 Ship Weight: 160		<b>1603</b>	<b>1627</b>	<b>1651</b>
<b>E2_4DF</b>	16" X 24" X 57.25" Cubic Ft: 14.5 Ship Weight: 165		<b>1695</b>	<b>1720</b>	<b>1746</b>
<b>Pulls:</b> BRUSHED CHROME <b>EW</b>   EBONY <b>EE</b>   BRIGHT BRASS <b>EB</b>   OVAL NICKEL <b>ED</b>					

Freight Class: 125

CONTEMPORARY LAMINATE





## CHARACTERISTICS

Atlas modular casegoods offer extensive choice for design flexibility, adapting to various building layouts, business structures and personal work requirements. The details below will help you understand the key components of Atlas.

## FINISH OPTIONS

– ALL COLORS ARE THE SAME PRICE –  
**Top/Base Colors**

**AP** Aspen                      **M** Mahogany  
**FM** Natural Maple        **WC** Windsor Cherry

### Base-Only Colors

**GP** Graphite                **PW** Pearwood  
**G** Grey                      **E** Black  
**X** Espresso                **CC** Classic Cherry  
**O** Medium Oak

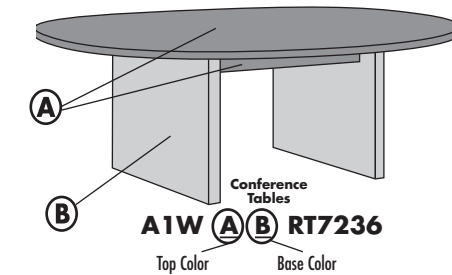
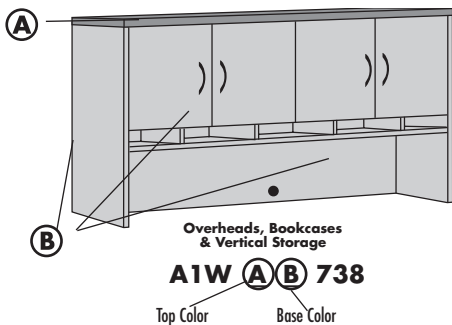
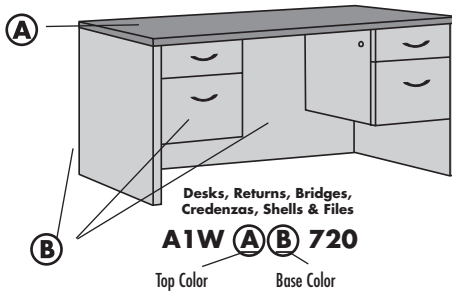

## PEDESTALS & FILE CABINETS

All cases are 3/4" thick core with thermally fused laminate on both sides and full 3 millimeter PVC AdvantEdge banding. Full modesty panels. Full or 3/4 height pedestals. Units fully assembled with dowels, glue, metal brackets and screws.

### Pedestal Option

All units with pedestals available with full-to-floor or 3/4 height pedestals.

## PULL OPTIONS

Choose curvilinear pulls in brushed chrome,

ebony or bright brass or oval nickel drawer/door pulls all constructed of solid metal. When ordering, use the corresponding pull designator at the beginning of the model number.

**A1W** Brushed Chrome    **A1B** Bright Brass  
**A1E** Ebony                **A1D** Oval Nickel

## TOPS

All tops are 1 1/2" thick with thermally fused laminate surface, proper backing and 3 millimeter PVC AdvantEdge banding as required. Tops have reeded edge on front and back of all units except bridges and returns which have reed edges on working side only. All bridge and return tops feature common grain direction with connecting units.

## PANELS

End panels are 1" thick core with thermally fused laminate on both sides and full 3 millimeter PVC AdvantEdge banding as required. Full modesty panels are 3/4" thick core with thermally fused laminate on both sides and full 3 millimeter PVC AdvantEdge banding as required. Heavy-duty adjustable nylon leveling glides in 5" steel plate.

## DRAWERS

All drawer fronts are constructed of 3/4" thick core with thermally fused laminate on both sides and full 3 millimeter PVC AdvantEdge banding as required. Drawer sides are 1/2" thick vinyl wrap with oak grain pattern. Drawer bottoms are 1/8" thick hardboard with oak grain pattern.

- All drawers suspended on smooth-action steel, ball-bearing slides
- File and lateral file drawers mounted on heavy-duty, ball-bearing, full-extension slides
- All file and lateral file drawers constructed for suspended filing with 25 lb maximum weight for bottom-loading
- Drawers constructed with 5 sides for extra strength and durability. Drawer front is the fifth side and is removable for field-repair or hardware additions

## FILING

All file drawers include pre-installed, black filing hardware, easily reconfigured by user to adapt to specific requirements.

- Black filing hardware includes pre-installed rails with easy-adjust crossbar
- All file drawers accommodate letter-size filing front-to-back and letter- or legal-size filing side-to-side
- All lateral file drawers accommodate letter or legal-size filing side-to-side and letter or legal-size filing front-to-back

## WIRE MANAGEMENT

See features for number of grommets and location. Additional grommets can be added for extended wire management capability at \$106 list per grommet. Includes factory cut and installed grommet and black sleeve. Call for special quote. Specify location and quote number with order.

## LOCKS

- Desk/credenza pedestals feature single-key side locking, keyed alike
- Two drawer lateral file features single-key front locking and counter weight
- Four-drawer lateral file features central locking and anti-tilt mechanism
- Two and four-drawer lateral files keyed alike
- All other locks are keyed identical unless otherwise specified
- 'Key Different' option is \$21 list upcharge per lock. Locks/cores packaged to customer requirements
- Additional lead time for 'Key Different'
- For optional locking on overhead storage units add **Y** to the end of the model number and add \$150 to the list price of units with four doors or two doors not adjoining. Add \$75 for units with two adjoining doors

## ACCESSORIES *Factory Installed*

Certain accessories can be ordered installed prior to shipment. Add letter designator (C or K) at end of the desk or credenza model number:

- C** Center Drawer  
*Example: E2WWC720C*
- K** Keyboard Platform  
*Example: EWWC704K*
- T** Task Light  
*Example: EWWC737T*

## QUICKSHIP

Quick Ship is not available on any items ordered with options.

## PACKING

All units are properly packed in heavy-duty cartons, protected with extra-thick corner pads, and foam-wrapped for additional security. All packaging conforms to or exceeds specifications as outlined in the Uniform Freight Classification.

All desks, credenzas, files and overhead storage units are shipped set up. Modular L, U, and reception stations are shipped in multiple cartons and require field connection.

## PALLETIZATION

See page 3.

## CARE AND CLEANING INSTRUCTIONS

**Normal cleaning:** Clean using a soft cloth and a good window cleaner which contains no ammonia, followed by wiping dry using a dry soft cloth.

**Specifications subject to change without notice.**

TOP BASE FINISHES

ASPEN **AP** | NATURAL MAPLE **FM** | WINDSOR CHERRY **WC** | MAHOGANY **M** |

BASE ONLY FINISHES

GRAPHITE **GP** | GREY **G** | ESPRESSO **X** | MEDIUM OAK **O** | PEARWOOD **PW** | BLACK **E** | CLASSIC CHERRY **CC** |

SIN 711-2 **ATLAS**

Configurations

Zone Pricing

1

2

3

**U Unit with Peninsula Desk & Maximum Kneespace**



72" x 108"

Description	Model Number	Qty	Frnt.Class	Cubic Ft.	Ship Weight	1	2	3	
Peninsula Desk	A1_799 72" x 36" x 29.5"	1	250	51.6	187	908	922	935	
Left Extended Corner Return	A1_450L 72" x 36/24" x 29.5"	1	200	52.4	218	1067	1083	1099	
Rectangular Shell-Full Left Leg	A1_RS2436L 36" x 24" x 29.5"	1	110	19.1	118	549	557	565	
Total:					123.10	523	2524	2562	2599

**L Unit with Computer Corner Desk**

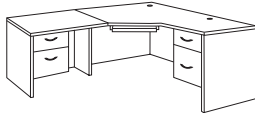

72" x 72"

Description	Model Number	Qty	Frnt.Class	Cubic Ft.	Ship Weight	1	2	3	
Right Pedestal Computer Corner Desk	A1_451R 72" x 36/24" x 29.5"	1	110	52.4	289	1788	1815	1842	
Left Pedestal Compact Return	A1_452L 36" x 24" x 29.5"	1	110	21.8	145	896	909	923	
Total:					74.20	434	2684	2724	2765

**Executive U Unit**

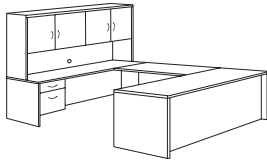

72" x 108" x 66.5"

Description	Model Number	Qty	Frnt.Class	Cubic Ft.	Ship Weight	1	2	3	
Right Pedestal Desk	A1_721R 72" x 36" x 29.5"	1	200	52.4	277	1330	1350	1370	
Left Pedestal Credenza	A1_725L 72" x 24" x 29.5"	1	125	36.3	202	1194	1212	1230	
Bridge	A1_485 48" x 24" x 29.5"	1	100	4.6	78	467	474	481	
Overhead Storage Unit with Doors	A1_737 72" x 16" x 37"	1	125	33.6	233	1289	1308	1328	
Task Light	TL2P 19.5" x 3.25" x 1.25"	1	200	1.0	3	124	126	128	
Total:					127.90	793	4404	4470	4537

**Executive Office with Extra Storage**



144" x 108" x 66.5"

Description	Model Number	Qty	Frnt.Class	Cubic Ft.	Ship Weight	1	2	3	
Double Pedestal Bow Front Desk	A1_720B 72" x 36" x 29.5"	1	110	52.4	307	1640	1665	1689	
Computer Credenza	A1_744 72" x 24" x 29.5"	1	110	36.3	293	1391	1412	1433	
Overhead Storage Unit with Doors	A1_737 72" x 16" x 37"	1	125	33.6	233	1289	1308	1328	
Storage Cabinet with Lateral File	A1_65STOR 36" x 24" x 66.5"	1	125	43.1	309	1915	1944	1972	
Five Shelf Bookcase	A1_65 36" x 16" x 66.5"	1	125	28.9	212	892	905	919	
Total:					194.30	1354	7127	7234	7341

**Executive U Unit with Curved Corner Desk**

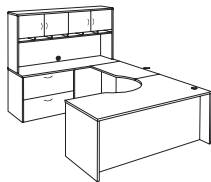

72" x 108" x 66.5"

Description	Model Number	Qty	Frnt.Class	Cubic Ft.	Ship Weight	1	2	3	
Right Pedestal Curved Corner Desk	A1_462R 72" x 42/30" x 29.5"	1	200	60.5	331	1813	1840	1867	
Asymmetrical Bridge	A1_495L 42" x 24" x 29.5"	1	125	4.6	67	572	581	589	
Left Lateral File Credenza	A1_733L 72" x 24" x 29.5"	1	125	36.3	261	1539	1562	1585	
Overhead Storage Unit with Doors and Paper Storage Shelves	A1_738 72" x 16" x 37"	1	125	33.6	252	1623	1647	1672	
Total:					135.00	911	5547	5630	5713

UNIT	KNEESPACE	OVERHANG
72" Double Pedestal Desk	38-1/4"	11"
66" Double Pedestal Desk	32-1/4"	5"
60" Double Pedestal Desk	26-1/4"	5"

UNIT	KNEESPACE	OVERHANG
72" Double Pedestal Credenza	38-1/4"	n/a
66" Double Pedestal Credenza	32-1/4"	n/a
72" Curved Corner Desk	n/a	5"

CONTEMPORARY LAMINATE



A1 **W** AP 720B  
Pull Finish

### Cluster Work Station (4 People)



144" x 144" x 66.5"

Description	Model Number	Qty	Frnt.Class	Cubic Ft.	Ship Weight	Zone Pricing				
						1	2	3		
Left Pedestal Computer Corner Desk	A1_451L 72" x 36/24" x 29.5"	4	110	52.4	289	<b>1788</b>	<b>1815</b>	<b>1842</b>		
Right Pedestal Compact Return	A1_452R 36" x 24" x 29.5"	4	110	21.8	145	<b>896</b>	<b>909</b>	<b>923</b>		
Open Overhead Storage Unit	A1_717 72" x 16" x 37"	4	125	33.6	193	<b>1032</b>	<b>1047</b>	<b>1063</b>		
Group Total:						431.20	2508	<b>14864</b>	<b>15084</b>	<b>15312</b>

### MultiStation with Privacy (2 People)

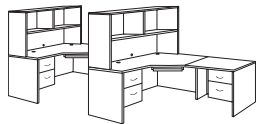

177" x 72" x 66.5"

Description	Model Number	Qty	Frnt.Class	Cubic Ft.	Ship Weight	Zone Pricing				
						1	2	3		
Left Pedestal Computer Corner Desk	A1_451L 72" x 36/24" x 29.5"	2	110	52.4	289	<b>1788</b>	<b>1815</b>	<b>1842</b>		
Right Pedestal Compact Return	A1_452R 36" x 24" x 29.5"	2	110	21.8	145	<b>896</b>	<b>909</b>	<b>923</b>		
Open Overhead Storage Unit	A1_717 72" x 16" x 37"	2	125	33.6	193	<b>1032</b>	<b>1047</b>	<b>1063</b>		
Group Total:						215.6	1254	<b>7432</b>	<b>7542</b>	<b>7656</b>

### Double Workstation (2 People)



180" x 72" x 66.5"

Description	Model Number	Qty	Frnt.Class	Cubic Ft.	Ship Weight	Zone Pricing				
						1	2	3		
Left Pedestal Credenza	A1_725L 72" x 24" x 29.5"	1	125	36.3	202	<b>1194</b>	<b>1212</b>	<b>1230</b>		
Right Pedestal Credenza	A1_725R 72" x 24" x 29.5"	1	125	36.3	202	<b>1194</b>	<b>1212</b>	<b>1230</b>		
Bridge	A1_485 48" x 24" x 29.5"	2	100	4.6	78	<b>467</b>	<b>474</b>	<b>481</b>		
Peninsula Desk	A1_799 72" x 36" x 29.5"	1	250	51.6	187	<b>908</b>	<b>922</b>	<b>935</b>		
Overhead Storage Unit with Doors	A1_737 72" x 16" x 37"	2	125	33.6	233	<b>1289</b>	<b>1308</b>	<b>1328</b>		
Open Overhead Storage	A1_317 36" x 16" x 37"	1	125	15.3	111	<b>529</b>	<b>537</b>	<b>545</b>		
Group Total:						215.9	1324	<b>7337</b>	<b>7447</b>	<b>7558</b>

### Reception Station

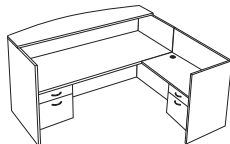

72" x 78" x 42.5"

Description	Model Number	Qty	Frnt.Class	Cubic Ft.	Ship Weight	Zone Pricing				
						1	2	3		
Left Pedestal Reception Desk	A1_7230L 72" x 36" x 42.5"	1	110	64.4	373	<b>1717</b>	<b>1743</b>	<b>1769</b>		
Right Pedestal Reception Return	A1_2442R 42" x 24" x 41"	1	110	32.9	205	<b>1140</b>	<b>1157</b>	<b>1174</b>		
Total:						97.30	578	<b>2857</b>	<b>2900</b>	<b>2943</b>

## DESKS

### Double Pedestal Bow Front Desk

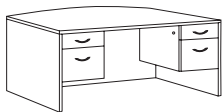

- Bow front top
- Box/File pedestals
- Pre-installed PROfile filing hardware
- Legal or letter filing
- Individual locking pedestals

Freight Class: 110

**A1\_720B QS** 72" X 36" X 29.5" Cubic Ft: 52.4 Ship Weight: 307 **1640** **1665** **1689**

<b>Center Drawer C</b>	177	180	180
<b>Keyboard Platform K</b>	203	206	209

**Pulls:** Bright Brass **A1B** | Brushed Chrome **A1W** | Ebony **A1E** | Oval Nickel **A1D**

**QS FINISHES** **FMGP** | **WC** | **QS PULLS** **W**

### Double Full Pedestal Bow Front Desk



- Bow front top
- File/File left pedestal
- Box/Box/File right pedestal
- Pre-installed black filing hardware
- Legal or letter filing
- Individual locking pedestals

Freight Class: 110

**A1\_720BF2BF** 72" X 36" X 29.5" Cubic Ft: 52.4 Ship Weight: 321 **2186** **2219** **2252**

<b>Center Drawer C</b>	177	180	182
<b>Keyboard Platform K</b>	203	206	209

**Pulls:** Bright Brass **A1B** | Brushed Chrome **A1W** | Ebony **A1E** | Oval Nickel **A1D**

TOP BASE FINISHES

ASPEN **AP** | NATURAL MAPLE **FM** | WINDSOR CHERRY **WC** | MAHOGANY **M** |

BASE ONLY FINISHES

GRAPHITE **GP** | GREY **G** | ESPRESSO **X** | MEDIUM OAK **O** | PEARWOOD **PW** | BLACK **E** | CLASSIC CHERRY **CC** |

SIN 711-2 **ATLAS**

Double Pedestal Desk

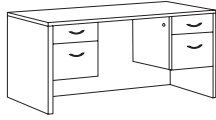

- Box/File pedestals
- Pre-installed, black filing hardware
- Legal or letter filing
- Individually side locking pedestals

Freight Class: 110

		Zone Pricing	1	2	3
<b>A1_720</b>	72" X 36" X 29.5" Cubic Ft: 52.4 Ship Weight: 316		<b>1486</b>	<b>1508</b>	<b>1531</b>
	<b>Center Drawer C</b>		177	180	182
	<b>Keyboard Platform K</b>		203	206	209
<b>A1_700</b>	72" X 30" X 29.5" Cubic Ft: 45.1 Ship Weight: 284		<b>1392</b>	<b>1413</b>	<b>1434</b>
	<b>Center Drawer C</b>		177	180	182
	<b>Keyboard Platform K</b>		203	206	209
<b>A1_660</b>	66" X 30" X 29.5" Cubic Ft: 41 Ship Weight: 270		<b>1391</b>	<b>1412</b>	<b>1433</b>
	<b>Center Drawer C</b>		177	180	182
	<b>Keyboard Platform K</b>		203	206	209
<b>A1_600</b>	60" X 30" X 29.5" Cubic Ft: 37.2 Ship Weight: 254		<b>1320</b>	<b>1340</b>	<b>1360</b>
	<b>Center Drawer C</b>		165	167	170
	<b>Keyboard Platform K</b>		196	199	202
<b>Pulls:</b>		Bright Brass <b>A1B</b>	Brushed Chrome <b>A1W</b>	Ebony <b>A1E</b>	Oval Nickel <b>A1D</b>

Double Full Pedestal Desk



- File/File left pedestal
- Box/Box/File right pedestal
- Pre-installed, black filing hardware
- Legal or letter filing
- Individually side locking pedestals

Freight Class: 110

<b>A1_720F2BF</b>	72" X 36" X 29.5" Cubic Ft: 52.4 Ship Weight: 357		<b>1921</b>	<b>1950</b>	<b>1979</b>
	<b>Center Drawer C</b>		177	180	182
	<b>Keyboard Platform K</b>		203	206	209
<b>A1_700F2BF</b>	72" X 30" X 29.5" Cubic Ft: 45.1 Ship Weight: 320		<b>1809</b>	<b>1836</b>	<b>1863</b>
	<b>Center Drawer C</b>		177	180	182
	<b>Keyboard Platform K</b>		203	206	209
<b>A1_660F2BF</b>	66" X 30" X 29.5" Cubic Ft: 41 Ship Weight: 320		<b>1786</b>	<b>1813</b>	<b>1840</b>
	<b>Center Drawer C</b>		177	180	182
	<b>Keyboard Platform K</b>		203	206	209
<b>A1_600F2BF</b>	60" X 30" X 29.5" Cubic Ft: 37.2 Ship Weight: 303		<b>1761</b>	<b>1787</b>	<b>1814</b>
	<b>Center Drawer C</b>		165	167	170
	<b>Keyboard Platform K</b>		196	199	202
<b>Pulls:</b>		Bright Brass <b>A1B</b>	Brushed Chrome <b>A1W</b>	Ebony <b>A1E</b>	Oval Nickel <b>A1D</b>

Left Pedestal Bow Front Desk

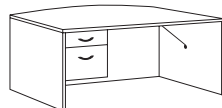

- Bow front top
- Box/File left pedestal
- Pre-installed, black filing hardware
- Legal or letter filing
- Side locking pedestal

Freight Class: 200

<b>A1_721LB QS</b>	72" X 36" X 29.5" Cubic Ft: 52.4 Ship Weight: 270		<b>1471</b>	<b>1493</b>	<b>1515</b>
	<b>Center Drawer C</b>		165	167	170
	<b>Keyboard Platform K</b>		196	199	202
<b>Pulls:</b>		Bright Brass <b>A1B</b>	Brushed Chrome <b>A1W</b>	Ebony <b>A1E</b>	Oval Nickel <b>A1D</b>
<b>QS FINISHES</b>		<b>FMGP</b>	<b>WC</b>	<b>QS PULLS</b>	
				<b>W</b>	

Right Pedestal Bow Front Desk

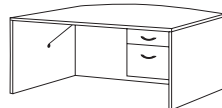

- Same description as above except:
- Box/File right pedestal

Freight Class: 200

<b>A1_721RB QS</b>	72" X 36" X 29.5" Cubic Ft: 52.4 Ship Weight: 270		<b>1471</b>	<b>1493</b>	<b>1515</b>
	<b>Center Drawer C</b>		165	167	170
	<b>Keyboard Platform K</b>		196	199	202
<b>Pulls:</b>		Bright Brass <b>A1B</b>	Brushed Chrome <b>A1W</b>	Ebony <b>A1E</b>	Oval Nickel <b>A1D</b>
<b>QS FINISHES</b>		<b>FMGP</b>	<b>WC</b>	<b>QS PULLS</b>	
				<b>W</b>	

Left Full Pedestal Bow Front Desk

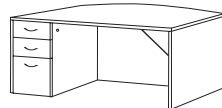

- Bow front top
- Box/Box/File left pedestal
- Pre-installed, black filing hardware
- Legal or letter filing
- Side locking pedestals

Freight Class: 110

<b>A1_721LB2BF</b>	72" X 36" X 29.5" Cubic Ft: 52.4 Ship Weight: 295		<b>1758</b>	<b>1784</b>	<b>1811</b>
	<b>Center Drawer C</b>		165	167	170
	<b>Keyboard Platform K</b>		196	199	202
<b>Pulls:</b>		Bright Brass <b>A1B</b>	Brushed Chrome <b>A1W</b>	Ebony <b>A1E</b>	Oval Nickel <b>A1D</b>

UNIT	KNEESPACE	OVERHANG
72" Double Pedestal Desk	38-1/4"	11"
66" Double Pedestal Desk	32-1/4"	5"
60" Double Pedestal Desk	26-1/4"	5"

UNIT	KNEESPACE	OVERHANG
72" Double Pedestal Credenza	38-1/4"	n/a
66" Double Pedestal Credenza	32-1/4"	n/a
72" Curved Corner Desk	n/a	5"

CONTEMPORARY LAMINATE



A1 **W** AP 721RB2BF  
 Pull                      Finish

Zone Pricing

1	2	3
---	---	---

### Right Full Pedestal Bow Front Desk

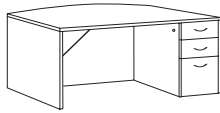

- Bow front top
- Box/Box/File right pedestal
- Pre-installed black filing hardware
- Legal or letter filing
- Side locking pedestal

Freight Class: 110

<b>A1_ 721RB2BF</b> 72" X 36" X 29.5" Cubic Ft: 52.4 Ship Weight: 295	<b>1758</b>	<b>1784</b>	<b>1811</b>
<b>Center Drawer C</b>	165	167	170
<b>Keyboard Platform K</b>	196	199	202

**Pulls:** Bright Brass **A1B** | Brushed Chrome **A1W** | Ebony **A1E** | Oval Nickel **A1D**

### Left Pedestal Desk

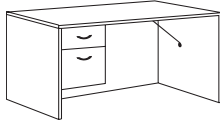

- Box/File left pedestal
- Pre-installed, black filing hardware
- Legal or letter filing
- Side locking pedestal

<b>A1_ 721L</b> 72" X 36" X 29.5" Cubic Ft: 52.4 Ship Weight: 277	<b>1330</b>	<b>1350</b>	<b>1370</b>
Freight Class: 200	<b>Center Drawer C</b>	165	167
	<b>Keyboard Platform K</b>	196	199

<b>A1_ 700L</b> 72" X 30" X 29.5" Cubic Ft: 45.1 Ship Weight: 250	<b>1206</b>	<b>1224</b>	<b>1242</b>
Freight Class: 110	<b>Center Drawer C</b>	165	167
	<b>Keyboard Platform K</b>	196	199

<b>A1_ 651L</b> 66" X 30" X 29.5" Cubic Ft: 41 Ship Weight: 239	<b>1177</b>	<b>1195</b>	<b>1212</b>
Freight Class: 110	<b>Center Drawer C</b>	165	167
	<b>Keyboard Platform K</b>	196	199

<b>A1_ 641L</b> 60" X 30" X 29.5" Cubic Ft: 37.2 Ship Weight: 218	<b>1148</b>	<b>1165</b>	<b>1182</b>
Freight Class: 110			

<b>A1_ 431L</b> 48" X 30" X 29.5" Cubic Ft: 31 Ship Weight: 194	<b>1050</b>	<b>1066</b>	<b>1082</b>
Freight Class: 110	<b>Center Drawer C</b>	165	167
	<b>Keyboard Platform K</b>	196	199

**Pulls:** Bright Brass **A1B** | Brushed Chrome **A1W** | Ebony **A1E** | Oval Nickel **A1D**

### Right Pedestal Desk

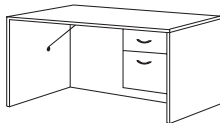

- Same description as above except:
- Box/File right pedestal

<b>A1_ 721R</b> 72" X 36" X 29.5" Cubic Ft: 52.4 Ship Weight: 277	<b>1330</b>	<b>1350</b>	<b>1370</b>
Freight Class: 200	<b>Center Drawer C</b>	165	167
	<b>Keyboard Platform K</b>	196	199

<b>A1_ 700R</b> 72" X 30" X 29.5" Cubic Ft: 45.1 Ship Weight: 250	<b>1206</b>	<b>1224</b>	<b>1242</b>
Freight Class: 110	<b>Center Drawer C</b>	165	167
	<b>Keyboard Platform K</b>	196	199

<b>A1_ 651R</b> 66" X 30" X 29.5" Cubic Ft: 41 Ship Weight: 239	<b>1177</b>	<b>1195</b>	<b>1212</b>
Freight Class: 110	<b>Center Drawer C</b>	165	167
	<b>Keyboard Platform K</b>	196	199

<b>A1_ 641R</b> 60" X 30" X 29.5" Cubic Ft: 37.2 Ship Weight: 218	<b>1148</b>	<b>1165</b>	<b>1182</b>
Freight Class: 110			

<b>A1_ 431R</b> 48" X 30" X 29.5" Cubic Ft: 31 Ship Weight: 194	<b>1050</b>	<b>1066</b>	<b>1082</b>
Freight Class: 110	<b>Center Drawer C</b>	165	167
	<b>Keyboard Platform K</b>	196	199

**Pulls:** Bright Brass **A1B** | Brushed Chrome **A1W** | Ebony **A1E** | Oval Nickel **A1D**

### Left Full Pedestal Desk

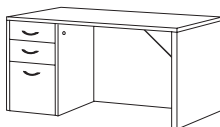

- Box/Box/File left pedestal
- Pre-installed, black filing hardware
- Legal or letter filing
- Side locking pedestal

<b>A1_ 721L2BF</b> 72" X 36" X 29.5" Cubic Ft: 52.4 Ship Weight: 302	<b>1499</b>	<b>1521</b>	<b>1544</b>
	<b>Center Drawer C</b>	165	167
	<b>Keyboard Platform K</b>	196	199

<b>A1_ 700L2BF</b> 72" X 30" X 29.5" Cubic Ft: 45.1 Ship Weight: 270	<b>1457</b>	<b>1479</b>	<b>1501</b>
	<b>Center Drawer C</b>	165	167
	<b>Keyboard Platform K</b>	196	199

<b>A1_ 651L2BF</b> 66" X 30" X 29.5" Cubic Ft: 41 Ship Weight: 264	<b>1407</b>	<b>1428</b>	<b>1449</b>
	<b>Center Drawer C</b>	165	167
	<b>Keyboard Platform K</b>	196	199

<b>A1_ 641L2BF</b> 60" X 30" X 29.5" Cubic Ft: 37.2 Ship Weight: 243	<b>1227</b>	<b>1245</b>	<b>1264</b>

<b>A1_ 431L2BF</b> 48" X 30" X 29.5" Cubic Ft: 31 Ship Weight: 219	<b>1115</b>	<b>1132</b>	<b>1148</b>
	<b>Center Drawer C</b>	165	167
	<b>Keyboard Platform K</b>	196	199

**Pulls:** Bright Brass **A1B** | Brushed Chrome **A1W** | Ebony **A1E** | Oval Nickel **A1D**

Freight Class: 110



TOP BASE FINISHES

ASPEN **AP** | NATURAL MAPLE **FM** | WINDSOR CHERRY **WC** | MAHOGANY **M** |

BASE ONLY FINISHES

GRAPHITE **GP** | GREY **G** | ESPRESSO **X** | MEDIUM OAK **O** | PEARWOOD **PW** | BLACK **E** | CLASSIC CHERRY **CC** |

SIN 711-2 **ATLAS**

Right Full Pedestal Desk

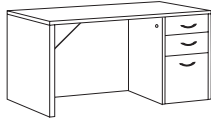

- Same description as above except:
- Box/Box/File right pedestal

Freight Class: 110

	Zone Pricing	1	2	3
<b>A1_ 721R2BF</b> 72" X 36" X 29.5" Cubic Ft: 52.4 Ship Weight: 302		<b>1499</b>	<b>1521</b>	<b>1544</b>
	<b>Center Drawer C</b>	165	167	170
	<b>Keyboard Platform K</b>	196	199	202
<b>A1_ 700R2BF</b> 72" X 30" X 29.5" Cubic Ft: 45.1 Ship Weight: 270		<b>1457</b>	<b>1479</b>	<b>1501</b>
	<b>Center Drawer C</b>	165	167	170
	<b>Keyboard Platform K</b>	196	199	202
<b>A1_ 651R2BF</b> 66" X 30" X 29.5" Cubic Ft: 41 Ship Weight: 264		<b>1407</b>	<b>1428</b>	<b>1449</b>
	<b>Center Drawer C</b>	165	167	170
	<b>Keyboard Platform K</b>	196	199	202
<b>A1_ 641R2BF</b> 60" X 30" X 29.5" Cubic Ft: 37.2 Ship Weight: 243		<b>1227</b>	<b>1245</b>	<b>1264</b>
<b>A1_ 431R2BF</b> 48" X 30" X 29.5" Cubic Ft: 31 Ship Weight: 219		<b>1115</b>	<b>1132</b>	<b>1148</b>
	<b>Center Drawer C</b>	165	167	170
	<b>Keyboard Platform K</b>	196	199	202
<b>Pulls:</b>	Bright Brass <b>A1B</b>   Brushed Chrome <b>A1W</b>   Ebony <b>A1E</b>   Oval Nickel <b>A1D</b>			

Corner Desks

Left Pedestal Computer Corner Desk



Freight Class: 110

- Locking Box/File left pedestal
- Pre-installed black filing hardware
- Legal or letter filing
- Easy computer pullup
- Keyboard platform standard
- One grommet in top, one in modesty panel and one in support leg

<b>A1_ 451L</b> 72" X 36/24" X 29.5" Cubic Ft: 52.4 Ship Weight: 289		<b>1788</b>	<b>1815</b>	<b>1842</b>
<b>Pulls:</b>	Bright Brass <b>A1B</b>   Brushed Chrome <b>A1W</b>   Ebony <b>A1E</b>   Oval Nickel <b>A1D</b>			

Right Pedestal Computer Corner Desk

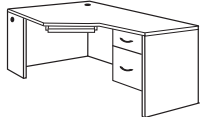

Freight Class: 110

- Same description as above except:
- Locking Box/File right pedestal

<b>A1_ 451R</b> 72" X 36/24" X 29.5" Cubic Ft: 52.4 Ship Weight: 289		<b>1788</b>	<b>1815</b>	<b>1842</b>
<b>Pulls:</b>	Bright Brass <b>A1B</b>   Brushed Chrome <b>A1W</b>   Ebony <b>A1E</b>   Oval Nickel <b>A1D</b>			

Left Full Pedestal Computer Corner Desk



Freight Class: 110

- Locking Box/Box/File left pedestal
- Pre-installed black filing hardware
- Legal or letter filing
- Easy computer pullup
- Keyboard platform standard
- One grommet in top, one in modesty panel and one in support leg

<b>A1_ 451L2BF</b> 72" X 36/24" X 29.5" Cubic Ft: 52.4 Ship Weight: 314		<b>1902</b>	<b>1931</b>	<b>1959</b>
<b>Pulls:</b>	Bright Brass <b>A1B</b>   Brushed Chrome <b>A1W</b>   Ebony <b>A1E</b>   Oval Nickel <b>A1D</b>			

Right Full Pedestal Computer Corner Desk



Freight Class: 110

- Same description as above except:
- Locking Box/Box/File right pedestal

<b>A1_ 451R2BF</b> 72" X 36/24" X 29.5" Cubic Ft: 52.4 Ship Weight: 314		<b>1902</b>	<b>1931</b>	<b>1959</b>
<b>Pulls:</b>	Bright Brass <b>A1B</b>   Brushed Chrome <b>A1W</b>   Ebony <b>A1E</b>   Oval Nickel <b>A1D</b>			

Left Pedestal Curved Corner Desk

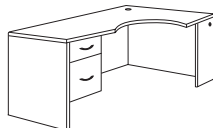

Freight Class: 200

- Use with right asymmetrical bridge or shell with 19" connection
- Locking Box/File left pedestal
- Pre-installed black filing hardware
- Legal or letter filing
- Full access worksurface
- One grommet in top and one in support leg

<b>A1_ 462L</b> 72" X 42-30" X 29.5" Cubic Ft: 60.5 Ship Weight: 331		<b>1813</b>	<b>1840</b>	<b>1867</b>
<b>Pulls:</b>	Bright Brass <b>A1B</b>   Brushed Chrome <b>A1W</b>   Ebony <b>A1E</b>   Oval Nickel <b>A1D</b>			

CONTEMPORARY LAMINATE



A1	W	AP	462R
	Pull		Finish

Zone Pricing

1

2

3

### Right Pedestal Curved Corner Desk

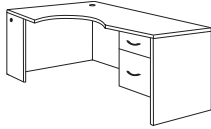

- Same description as above except:
- Locking Box/File right pedestal
- Use with left asymmetrical bridge or shell with 19" connection

Freight Class: 200

**A1\_462R** 72" X 42-30" X 29.5" Cubic Ft: 60.5 Ship Weight: 331 **1813** **1840** **1867**

**Pulls:** Bright Brass **A1B** | Brushed Chrome **A1W** | Ebony **A1E** | Oval Nickel **A1D**

### Left Full Pedestal Curved Corner Desk

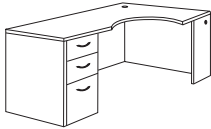

- Use with right asymmetrical bridge or shell with 19" connection
- Locking Box/Box/File left pedestal
- Pre-installed, black filing hardware
- Legal or letter filing
- Full-access worksurface

Freight Class: 110

**A1\_462L2BF** 72" X 42-30" X 29.5" Cubic Ft: 60.5 Ship Weight: 356 **1930** **1959** **1988**

**Pulls:** Bright Brass **A1B** | Brushed Chrome **A1W** | Ebony **A1E** | Oval Nickel **A1D**

### Right Full Pedestal Curved Corner Desk

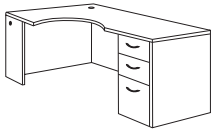

- Same description as above except:
- Locking Box/Box/File right pedestal
- Use with left asymmetrical bridge or shell with 19" connection

Freight Class: 110

**A1\_462R2BF** 72" X 42-30" X 29.5" Cubic Ft: 60.5 Ship Weight: 356 **1930** **1959** **1988**

**Pulls:** Bright Brass **A1B** | Brushed Chrome **A1W** | Ebony **A1E** | Oval Nickel **A1D**

## Peninsula Desks

### Peninsula Desk

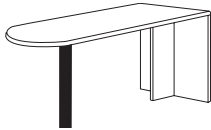

- Use with returns, bridges or rectangular shells
- Steel 4" diameter black cylinder base with leveling glide
- End support panel

Freight Class: 250

**A1\_799** 72" X 36" X 29.5" Cubic Ft: 51.6 Ship Weight: 187 **908** **922** **935**

### Peninsula Desk with Modesty Panel

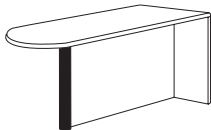

- Use with returns or bridges
- Steel 4" diameter black cylinder base with leveling glide
- End support panel

Freight Class: 250

**A1\_798** 72" X 36" X 29.5" Cubic Ft: 51.6 Ship Weight: 211 **1056** **1072** **1088**

### Peninsula Top and Column

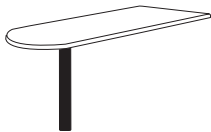

- Connect unsupported end to rectangular shell or credenza
- Steel 4" diameter black cylinder base with leveling glide
- Assembly required

Freight Class: 100

**A1\_797** 72" X 36" X 29.5" Cubic Ft: 15.6 Ship Weight: 127 **855** **868** **881**

## Credenzas

### Double Lateral File Credenza



- Four lateral file drawers
- Pre-installed, black filing hardware
- Legal or letter filing
- Front locking

Freight Class: 125

**A1\_733** 72.5" X 24" X 29.5" Cubic Ft: 36.3 Ship Weight: 331 **1946** **1975** **2004**

**Pulls:** Bright Brass **A1B** | Brushed Chrome **A1W** | Ebony **A1E** | Oval Nickel **A1D**

**EXTRA THICK BOTTOM** \$320 H

TOP BASE FINISHES

ASPEN **AP** | NATURAL MAPLE **FM** | WINDSOR CHERRY **WC** | MAHOGANY **M** |

BASE ONLY FINISHES

GRAPHITE **GP** | GREY **G** | ESPRESSO **X** | MEDIUM OAK **O** | PEARWOOD **PW** | BLACK **E** | CLASSIC CHERRY **CC** |

SIN 711-2 **ATLAS**

Left Lateral File/Bookcase Credenza



- Two lateral file drawers on left
- Front locking lateral file
- Pre-installed, black filing hardware
- Legal or letter filing
- Bookcase with doors and adjustable shelf on right

Freight Class: 125

Right Lateral File/Bookcase Credenza

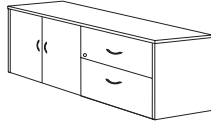

- Same description as above except:
- Lateral file on right
- Bookcase on left

Freight Class: 125

Double Bookcase Credenza

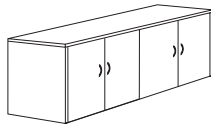

- Two bookcase compartments, each with one adjustable shelf
- Inside compartment dimensions: 34" x 21" x 25"

Freight Class: 125

Computer Credenza

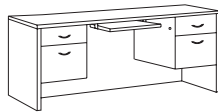

- Keyboard platform standard
- Box/File pedestals
- Pre-installed, black filing hardware
- Legal or letter filing
- Grommet in modesty panel
- Individually locking pedestals

Freight Class: 110

Full Pedestal Computer Credenza



- Same description as above except:
- File/File pedestals

Freight Class: 110

Left Pedestal Credenza

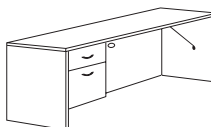

- Box/File left pedestal
- Pre-installed, black filing hardware
- Legal or letter filing
- Side locking
- One wire management grommet in modesty panel
- Use 60" x 24" credenza with 42" x 19" bridge

Freight Class: 125

Right Pedestal Credenza

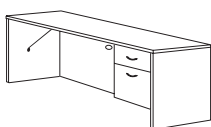

- Same description as above except:
- Box/File right pedestal

Freight Class: 125

Zone Pricing

1

2

3

**A1\_\_BK733L** 72.5" X 24" X 29.5" Cubic Ft: 36.3 Ship Weight: 338 **1848** **1876** **1903**

**Pulls:** Bright Brass **A1B** | Brushed Chrome **A1W** | Ebony **A1E** | Oval Nickel **A1D**

**EXTRA THICK BOTTOM** \$160 **H**

**A1\_\_BK733** 72.5" X 24" X 29.5" Cubic Ft: 36.3 Ship Weight: 338 **1848** **1876** **1903**

**Pulls:** Bright Brass **A1B** | Brushed Chrome **A1W** | Ebony **A1E** | Oval Nickel **A1D**

**EXTRA THICK BOTTOM** \$160 **H**

**A1\_\_734** 72.5" X 24" X 29.5" Cubic Ft: 36.3 Ship Weight: 345 **1529** **1552** **1575**

**Pulls:** Bright Brass **A1B** | Brushed Chrome **A1W** | Ebony **A1E** | Oval Nickel **A1D**

**A1\_\_744 QS** 72" X 24" X 29.5" Cubic Ft: 36.3 Ship Weight: 293 **1391** **1412** **1433**

**A1\_\_644** 66" X 24" X 29.5" Cubic Ft: 33.4 Ship Weight: 266 **1359** **1379** **1400**

**Pulls:** Bright Brass **A1B** | Brushed Chrome **A1W** | Ebony **A1E** | Oval Nickel **A1D**

**QS FINISHES** **FMGP** **WC** **QS PULLS** **W**

**A1\_\_744F** 72" X 24" X 29.5" Cubic Ft: 36.3 Ship Weight: 323 **1659** **1684** **1709**

**A1\_\_644F** 66" X 24" X 29.5" Cubic Ft: 33.4 Ship Weight: 296 **1614** **1638** **1662**

**Pulls:** Bright Brass **A1B** | Brushed Chrome **A1W** | Ebony **A1E** | Oval Nickel **A1D**

**A1\_\_725L** 72" X 24" X 29.5" Cubic Ft: 36.3 Ship Weight: 202 **1194** **1212** **1230**

**Center Drawer C** 165 167 170

**Keyboard Platform K** 196 199 202

**A1\_\_625L** 66" X 24" X 29.5" Cubic Ft: 33.4 Ship Weight: 190 **1156** **1173** **1191**

**Center Drawer C** 165 167 170

**Keyboard Platform K** 196 199 202

**A1\_\_615L** 60" X 24" X 29.5" Cubic Ft: 31 Ship Weight: 179 **1125** **1142** **1159**

**Pulls:** Bright Brass **A1B** | Brushed Chrome **A1W** | Ebony **A1E** | Oval Nickel **A1D**

**A1\_\_725R** 72" X 24" X 29.5" Cubic Ft: 36.3 Ship Weight: 202 **1194** **1212** **1230**

**Center Drawer C** 165 167 170

**Keyboard Platform K** 196 199 202

**A1\_\_625R** 66" X 24" X 29.5" Cubic Ft: 33.4 Ship Weight: 190 **1156** **1173** **1191**

**Center Drawer C** 165 167 170

**Keyboard Platform K** 196 199 202

**A1\_\_615R** 60" X 24" X 29.5" Cubic Ft: 31 Ship Weight: 179 **1125** **1142** **1159**

**Pulls:** Bright Brass **A1B** | Brushed Chrome **A1W** | Ebony **A1E** | Oval Nickel **A1D**

CONTEMPORARY LAMINATE



A1 **W** AP 725LF  
 Pull      Finish

### Left Full Pedestal Credenza



- File/File left pedestal
- Pre-installed, black filing hardware
- Legal or letter filing
- Side locking
- One wire management grommet in modesty panel

Freight Class: 125

### Right Full Pedestal Credenza



- Same description as above except:
- File/File right pedestal

Freight Class: 125

### Left Lateral File Credenza



- Two lateral file drawers on left
- Pre-installed, black filing hardware
- Legal or letter filing
- Front locking

Freight Class: 125

### Right Lateral File Credenza

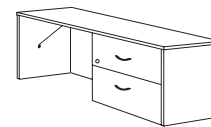

- Same description as above except:
- Two lateral file drawers on right

Freight Class: 125

### MultiFile Credenza

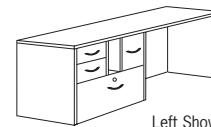

Left Shown

- One lateral file drawer with lock
- One file drawer
- Pre-installed, black filing hardware
- Legal or letter filing
- Two box drawers
- HOT PROJECTS ACCESS SLOT

Freight Class: 125

## Returns & Bridges

### Left MultiFile Return



- Lateral file drawer with lock
- File drawer
- Pre-installed, black filing hardware
- Legal or letter filing
- Two box drawers
- HOT PROJECTS ACCESS SLOT
- Connects with single pedestal desks or credenzas
- One grommet in modesty panel

Freight Class: 110

Zone Pricing

1      2      3

<b>A1__725LF</b> 72" X 24" X 29.5" Cubic Ft: 36.3 Ship Weight: 217	<b>1374</b>	<b>1395</b>	<b>1415</b>
Center Drawer C	165	167	170
Keyboard Platform K	196	199	202

<b>A1__625LF</b> 66" X 24" X 29.5" Cubic Ft: 33.4 Ship Weight: 205	<b>1358</b>	<b>1378</b>	<b>1399</b>
Center Drawer C	165	167	170
Keyboard Platform K	196	199	202

<b>A1__615LF</b> 60" X 24" X 29.5" Cubic Ft: 31 Ship Weight: 194	<b>1341</b>	<b>1361</b>	<b>1381</b>
--	-------------	-------------	-------------

**Pulls:** Bright Brass **A1B** | Brushed Chrome **A1W** | Ebony **A1E** | Oval Nickel **A1D**

<b>A1__725RF</b> 72" X 24" X 29.5" Cubic Ft: 36.3 Ship Weight: 217	<b>1374</b>	<b>1395</b>	<b>1415</b>
Center Drawer C	165	167	170
Keyboard Platform K	196	199	202

<b>A1__625RF</b> 66" X 24" X 29.5" Cubic Ft: 33.4 Ship Weight: 205	<b>1358</b>	<b>1378</b>	<b>1399</b>
Center Drawer C	165	167	170
Keyboard Platform K	196	199	202

<b>A1__615RF</b> 60" X 24" X 29.5" Cubic Ft: 31 Ship Weight: 194	<b>1341</b>	<b>1361</b>	<b>1381</b>
--	-------------	-------------	-------------

**Pulls:** Bright Brass **A1B** | Brushed Chrome **A1W** | Ebony **A1E** | Oval Nickel **A1D**

<b>A1__733L QS</b> 72" X 24" X 29.5" Cubic Ft: 36.3 Ship Weight: 261	<b>1539</b>	<b>1562</b>	<b>1585</b>
--	-------------	-------------	-------------

**Pulls:** Bright Brass **A1B** | Brushed Chrome **A1W** | Ebony **A1E** | Oval Nickel **A1D**

**QS FINISHES** FMGP WC **QS PULLS** W

**EXTRA THICK BOTTOM** \$160 H

<b>A1__733R QS</b> 72" X 24" X 29.5" Cubic Ft: 36.3 Ship Weight: 261	<b>1539</b>	<b>1562</b>	<b>1585</b>
--	-------------	-------------	-------------

**Pulls:** Bright Brass **A1B** | Brushed Chrome **A1W** | Ebony **A1E** | Oval Nickel **A1D**

**QS FINISHES** FMGP WC **QS PULLS** W

**EXTRA THICK BOTTOM** \$160 H

<b>A1__735L</b> 72" X 24" X 29.5" Cubic Ft: 36.3 Ship Weight: 286	<b>1591</b>	<b>1615</b>	<b>1639</b>
---	-------------	-------------	-------------

<b>A1__735R</b> 72" X 24" X 29.5" Cubic Ft: 36.3 Ship Weight: 286	<b>1591</b>	<b>1615</b>	<b>1639</b>
---	-------------	-------------	-------------

**Pulls:** Bright Brass **A1B** | Brushed Chrome **A1W** | Ebony **A1E** | Oval Nickel **A1D**

**EXTRA THICK BOTTOM** \$80 H

<b>A1__735LRT</b> 72" X 24" X 29.5" Cubic Ft: 36.3 Ship Weight: 280	<b>1591</b>	<b>1615</b>	<b>1639</b>
---	-------------	-------------	-------------

Keyboard Platform K	196	199	202
---------------------	-----	-----	-----

**Pulls:** Bright Brass **A1B** | Brushed Chrome **A1W** | Ebony **A1E** | Oval Nickel **A1D**

**EXTRA THICK BOTTOM** \$80 H

**TOP BASE FINISHES**

ASPEN **AP** | NATURAL MAPLE **FM** | WINDSOR CHERRY **WC** | MAHOGANY **M** |

**BASE ONLY FINISHES**

GRAPHITE **GP** | GREY **G** | ESPRESSO **X** | MEDIUM OAK **O** | PEARWOOD **PW** | BLACK **E** | CLASSIC CHERRY **CC** |

SIN 711-2 **ATLAS**

**Right MultiFile Return**

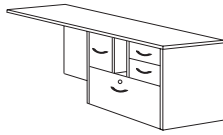

Freight Class: 110

- Lateral file drawer with lock
- File drawer
- Pre-installed, black filing hardware
- Legal or letter filing
- Two box drawers
- HOT PROJECTS ACCESS SLOT
- Connects with single pedestal desks or credenzas
- One grommet in modesty panel

**Left Pedestal Desk Height Return**

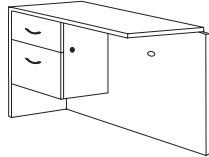

Freight Class: 110

- Box/File left pedestal
- Pre-installed, black filing hardware
- Legal or letter filing
- Side locking
- Wire management grommet in modesty panel

**Right Pedestal Desk Height Return**

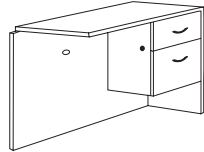

Freight Class: 110

- Same description as above except:
- Box/File right pedestal

**Left Full Pedestal Desk Height Return**

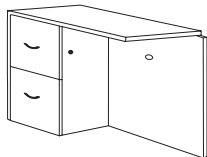

Freight Class: 110

- File/File left pedestal
- Pre-installed, black filing hardware
- Legal or letter filing
- Side locking
- Wire management grommet in modesty panel

**Right Full Pedestal Desk Height Return**

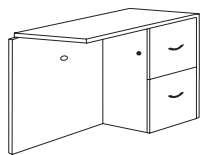

Freight Class: 110

- Same description as above except:
- File/File right pedestal

**Desk Height Bridge**

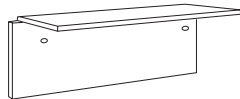

Freight Class: 100

- Use A1\_384 with 60" desks to allow more kneespace
- Two wire management grommets in modesty panel
- Requires assembly of top to modesty panel

**Extended Corners & Returns**

**Left Extended Corner-Two Full Legs**

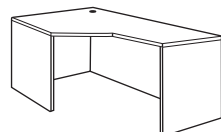

Freight Class: 200

- Corner on left
- Easy computer pullup
- One grommet in top, one in modesty panel
- Freestanding

Zone Pricing	1	2	3
--------------	---	---	---

<b>A1_735RRT</b> 72" X 24" X 29.5" Cubic Ft: 36.3 Ship Weight: 280	<b>1591</b>	<b>1615</b>	<b>1639</b>
<b>Keyboard Platform K</b>	196	199	202

**Pulls:** Bright Brass **A1B** | Brushed Chrome **A1W** | Ebony **A1E** | Oval Nickel **A1D**

**EXTRA THICK BOTTOM** \$80 **H**

<b>A1_722L</b> 48" X 24" X 29.5" Cubic Ft: 24.7 Ship Weight: 166	<b>943</b>	<b>957</b>	<b>971</b>
<b>Keyboard Platform K</b>	196	199	202

<b>A1_622L</b> 42" X 24" X 29.5" Cubic Ft: 21.8 Ship Weight: 156	<b>898</b>	<b>911</b>	<b>925</b>
<b>Keyboard Platform K</b>	196	199	202

<b>A1_452L</b> 36" X 24" X 29.5" Cubic Ft: 21.8 Ship Weight: 145	<b>896</b>	<b>909</b>	<b>923</b>
--	------------	------------	------------

**Pulls:** Bright Brass **A1B** | Brushed Chrome **A1W** | Ebony **A1E** | Oval Nickel **A1D**

<b>A1_722R</b> 48" X 24" X 29.5" Cubic Ft: 24.7 Ship Weight: 166	<b>943</b>	<b>957</b>	<b>971</b>
<b>Keyboard Platform K</b>	196	199	202

<b>A1_622R</b> 42" X 24" X 29.5" Cubic Ft: 21.8 Ship Weight: 156	<b>898</b>	<b>911</b>	<b>925</b>
<b>Keyboard Platform K</b>	196	199	202

<b>A1_452R</b> 36" X 24" X 29.5" Cubic Ft: 21.8 Ship Weight: 145	<b>896</b>	<b>909</b>	<b>923</b>
--	------------	------------	------------

**Pulls:** Bright Brass **A1B** | Brushed Chrome **A1W** | Ebony **A1E** | Oval Nickel **A1D**

<b>A1_722LF</b> 48" X 24" X 29.5" Cubic Ft: 24.7 Ship Weight: 182	<b>1140</b>	<b>1157</b>	<b>1174</b>
<b>Keyboard Platform K</b>	196	199	202

<b>A1_622LF</b> 42" X 24" X 29.5" Cubic Ft: 21.8 Ship Weight: 172	<b>1123</b>	<b>1140</b>	<b>1157</b>
<b>Keyboard Platform K</b>	196	199	202

<b>A1_452LF</b> 36" X 24" X 29.5" Cubic Ft: 21.8 Ship Weight: 161	<b>1103</b>	<b>1120</b>	<b>1136</b>
---	-------------	-------------	-------------

**Pulls:** Bright Brass **A1B** | Brushed Chrome **A1W** | Ebony **A1E** | Oval Nickel **A1D**

<b>A1_722RF</b> 48" X 24" X 29.5" Cubic Ft: 24.7 Ship Weight: 182	<b>1140</b>	<b>1157</b>	<b>1174</b>
<b>Keyboard Platform K</b>	196	199	202

<b>A1_622RF</b> 42" X 24" X 29.5" Cubic Ft: 21.8 Ship Weight: 172	<b>1123</b>	<b>1140</b>	<b>1157</b>
<b>Keyboard Platform K</b>	196	199	202

<b>A1_452RF</b> 36" X 24" X 29.5" Cubic Ft: 21.8 Ship Weight: 161	<b>1103</b>	<b>1120</b>	<b>1136</b>
---	-------------	-------------	-------------

**Pulls:** Bright Brass **A1B** | Brushed Chrome **A1W** | Ebony **A1E** | Oval Nickel **A1D**

<b>A1_485 QS</b> 48" X 24" X 29.5" Cubic Ft: 4.6 Ship Weight: 78	<b>467</b>	<b>474</b>	<b>481</b>
--	------------	------------	------------

<b>A1_484</b> 42" X 24" X 29.5" Cubic Ft: 4.6 Ship Weight: 69	<b>421</b>	<b>427</b>	<b>434</b>
---	------------	------------	------------

<b>A1_384</b> 42" X 19" X 29.5" Cubic Ft: 4.6 Ship Weight: 57	<b>426</b>	<b>432</b>	<b>439</b>
---	------------	------------	------------

**Pulls:** Bright Brass **A1B** | Brushed Chrome **A1W** | Ebony **A1E** | Oval Nickel **A1D**

**QS FINISHES FMGP WC**

CONTEMPORARY LAMINATE



Zone Pricing

1

2

3

### Right Extended Corner - Two Full Legs

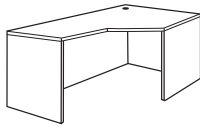

- Same description as above except:
- Corner on right

Freight Class: 200

<b>A1_475R</b>	72" X 36/24" X 29.5"	Cubic Ft: 52.4	Ship Weight: 239	<b>1067</b>	<b>1083</b>	<b>1099</b>
				<b>Keyboard Platform K</b>	196	202
<b>A1_465R</b>	66" X 36/24" X 29.5"	Cubic Ft: 49	Ship Weight: 226	<b>1019</b>	<b>1034</b>	<b>1050</b>
				<b>Keyboard Platform K</b>	196	202

### Left Extended Corner - Full Right, Half Left Leg

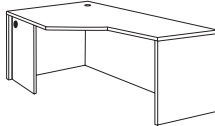

- Corner on left
- Easy computer pullup
- One grommet in top, one in modesty panel and one in half leg
- Corner may connect with return or bridge with credenza or desk
- Freestanding

Freight Class: 200

<b>A1_476L</b>	72" X 36/24" X 29.5"	Cubic Ft: 52.4	Ship Weight: 226	<b>1067</b>	<b>1083</b>	<b>1099</b>
				<b>Keyboard Platform K</b>	196	202
<b>A1_466L</b>	66" X 36/24" X 29.5"	Cubic Ft: 49	Ship Weight: 216	<b>1019</b>	<b>1034</b>	<b>1050</b>
				<b>Keyboard Platform K</b>	196	202

### Right Extended Corner - Full Left, Half Right Leg

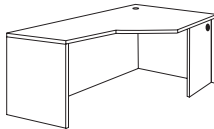

- Same description as above except:
- Corner on right

Freight Class: 200

<b>A1_476R</b>	72" X 36/24" X 29.5"	Cubic Ft: 52.4	Ship Weight: 226	<b>1067</b>	<b>1083</b>	<b>1099</b>
				<b>Keyboard Platform K</b>	196	202
<b>A1_466R</b>	66" X 36/24" X 29.5"	Cubic Ft: 49	Ship Weight: 216	<b>1019</b>	<b>1034</b>	<b>1050</b>
				<b>Keyboard Platform K</b>	196	202

### Left Extended Corner Return - Half Left Leg

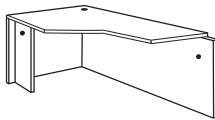

- Must connect to desk at 24" deep end
- Corner on left; connectable
- Easy computer pullup
- One grommet in top, two in modesty panel, one in half leg
- Not freestanding

Freight Class: 200

<b>A1_450L</b>	72" X 36/24" X 29.5"	Cubic Ft: 52.4	Ship Weight: 218	<b>1067</b>	<b>1083</b>	<b>1099</b>
				<b>Keyboard Platform K</b>	196	202

### Right Extended Corner Return - Half Right Leg

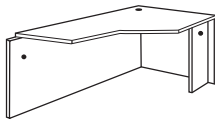

- Same description as above except:
- Corner on right; connectable

Freight Class: 200

<b>A1_450R</b>	72" X 36/24" X 29.5"	Cubic Ft: 52.4	Ship Weight: 218	<b>1067</b>	<b>1083</b>	<b>1099</b>
				<b>Keyboard Platform K</b>	196	202

### Left Extended Corner - Two Half Legs

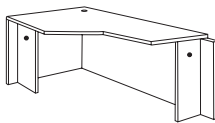

- Must connect to desk at 24" deep end
- Corner on left; connectable
- Easy computer pullup
- One grommet in top, two in modesty panel and one in each half leg
- Not freestanding

Freight Class: 200

<b>A1_450LH</b>	72" X 36/24" X 29.5"	Cubic Ft: 52.4	Ship Weight: 229	<b>1067</b>	<b>1083</b>	<b>1099</b>
				<b>Keyboard Platform K</b>	196	202
<b>A1_440LH</b>	66" X 36/24" X 29.5"	Cubic Ft: 49	Ship Weight: 206	<b>1019</b>	<b>1034</b>	<b>1050</b>
				<b>Keyboard Platform K</b>	196	202

### Right Extended Corner - Two Half Legs

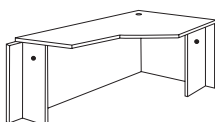

- Same description as above except:
- Corner on right; connectable

Freight Class: 200

<b>A1_450RH</b>	72" X 36/24" X 29.5"	Cubic Ft: 52.4	Ship Weight: 229	<b>1067</b>	<b>1083</b>	<b>1099</b>
				<b>Keyboard Platform K</b>	196	202
<b>A1_440RH</b>	66" X 36/24" X 29.5"	Cubic Ft: 49	Ship Weight: 206	<b>1019</b>	<b>1034</b>	<b>1050</b>
				<b>Keyboard Platform K</b>	196	202



TOP BASE FINISHES

ASPEN **AP** | NATURAL MAPLE **FM** | WINDSOR CHERRY **WC** | MAHOGANY **M** |

BASE ONLY FINISHES

GRAPHITE **GP** | GREY **G** | ESPRESSO **X** | MEDIUM OAK **O** | PEARWOOD **PW** | BLACK **E** | CLASSIC CHERRY **CC** |

SIN 711-2 **ATLAS**

**Left Extended Corner - Full Left, Half Right Leg**

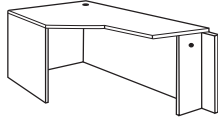

- Must connect to desk at 24" deep end
- Corner on left; connectable
- Easy computer pullup
- One grommet in top, two in modesty panel and one in each half leg
- Not freestanding

Freight Class: 200

**Right Extended Corner - Full Right, Half Left Leg**

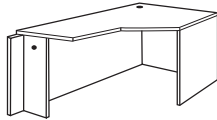

- Same description as above except:
- Corner on right; connectable

Freight Class: 200

**Asymmetrical Shells & Bridges**

**Left Asymmetrical Bridge**

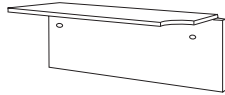

- Connects with right curved corner desk
- Connects at both ends; not freestanding
- Radius 19" deep right end
- Two grommets in modesty panel
- Assembly required

Freight Class: 100

**Right Asymmetrical Bridge**

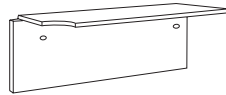

- Connects with left curved corner desk
- Connects at both ends; not freestanding
- Radius 19" deep right end
- Two grommets in modesty panel
- Requires assembly

Freight Class: 100

**Left Asymmetrical Shell**

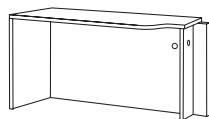

- Connects with right curved corner desks
- Grommet in modesty panel and half leg

**Right Asymmetrical Shell**



- Connects with left curved corner desks
- Grommet in modesty panel and half leg

		Zone Pricing	1	2	3
<b>A1_450LF</b>	72" X 36/24" X 29.5" Cubic Ft: 52.4 Ship Weight: 239		<b>1067</b>	<b>1083</b>	<b>1099</b>
	<b>Keyboard Platform K</b>		196	199	202
<b>A1_440LF</b>	66" X 36/24" X 29.5" Cubic Ft: 49 Ship Weight: 216		<b>1019</b>	<b>1034</b>	<b>1050</b>
	<b>Keyboard Platform K</b>		196	199	202
<b>A1_450RF</b>	72" X 36/24" X 29.5" Cubic Ft: 52.4 Ship Weight: 239		<b>1067</b>	<b>1083</b>	<b>1099</b>
	<b>Keyboard Platform K</b>		196	199	202
<b>A1_440RF</b>	66" X 36/24" X 29.5" Cubic Ft: 49 Ship Weight: 216		<b>1019</b>	<b>1034</b>	<b>1050</b>
	<b>Keyboard Platform K</b>		196	199	202

<b>A1_496L</b>	48" X 24" X 29.5" Cubic Ft: 4.6 Ship Weight: 78		<b>585</b>	<b>594</b>	<b>603</b>
<b>A1_495L</b>	42" X 24" X 29.5" Cubic Ft: 4.6 Ship Weight: 67		<b>572</b>	<b>581</b>	<b>589</b>

<b>A1_496R</b>	48" X 24" X 29.5" Cubic Ft: 4.6 Ship Weight: 78		<b>585</b>	<b>594</b>	<b>603</b>
<b>A1_495R</b>	42" X 24" X 29.5" Cubic Ft: 4.6 Ship Weight: 67		<b>572</b>	<b>581</b>	<b>589</b>

<b>A1_194824L</b>	48" X 24" X 29.5" Cubic Ft: 24.7 Ship Weight: 135		<b>780</b>	<b>792</b>	<b>803</b>
	Freight Class: 200				
<b>A1_194224L</b>	42" X 24" X 29.5" Cubic Ft: 22 Ship Weight: 125		<b>718</b>	<b>729</b>	<b>740</b>
	Freight Class: 110				

<b>A1_194824R</b>	48" X 24" X 29.5" Cubic Ft: 24.7 Ship Weight: 135		<b>780</b>	<b>792</b>	<b>803</b>
	Freight Class: 200				
<b>A1_194224R</b>	42" X 24" X 29.5" Cubic Ft: 22 Ship Weight: 125		<b>718</b>	<b>729</b>	<b>740</b>
	Freight Class: 110				

CONTEMPORARY LAMINATE



## Shells 30" Deep

Zone Pricing

1

2

3

### Freestanding 30" Deep Rectangular Shell

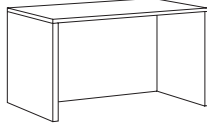

- Optional utility pedestals available
- Freestanding with two full legs

<b>A1_RS3072</b>	72" X 30" X 29.5"	Cubic Ft: 45.1	Ship Weight: 222	<b>741</b>	<b>752</b>	<b>763</b>
<b>A1_RS3066</b>	66" X 30" X 29.5"	Cubic Ft: 41	Ship Weight: 213	<b>719</b>	<b>730</b>	<b>741</b>
<b>A1_RS3060</b>	60" X 30" X 29.5"	Cubic Ft: 37.2	Ship Weight: 203	<b>719</b>	<b>730</b>	<b>741</b>
Freight Class: 200						
<b>A1_RS3048</b>	48" X 30" X 29.5"	Cubic Ft: 31	Ship Weight: 194	<b>640</b>	<b>650</b>	<b>659</b>
<b>A1_RS3042</b>	42" X 30" X 29.5"	Cubic Ft: 27	Ship Weight: 184	<b>610</b>	<b>619</b>	<b>628</b>
<b>A1_RS3036</b>	36" X 30" X 29.5"	Cubic Ft: 23.4	Ship Weight: 174	<b>578</b>	<b>587</b>	<b>595</b>
<b>A1_RS3030</b>	30" X 30" X 29.5"	Cubic Ft: 19.8	Ship Weight: 164	<b>549</b>	<b>557</b>	<b>565</b>
Freight Class: 110						

### 30" Deep Rectangular Shell/Bridge

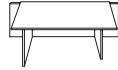
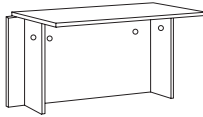

Support legs on 72", 66" and 60" lengths should be relocated inward (12" from either end) for increased worksurface support

- Two half legs
- Connects at both ends, not freestanding
- Two grommets in modesty, two in support/half legs
- Assembly required



Support legs on 48", 42" and 36" and 30" lengths located close to ends

<b>A1_RS3072H</b>	72" X 30" X 29.5"	Cubic Ft: 7.2	Ship Weight: 176	<b>741</b>	<b>752</b>	<b>763</b>
<b>A1_RS3066H</b>	66" X 30" X 29.5"	Cubic Ft: 6.2	Ship Weight: 162	<b>719</b>	<b>730</b>	<b>741</b>
<b>A1_RS3060H</b>	60" X 30" X 29.5"	Cubic Ft: 6	Ship Weight: 148	<b>719</b>	<b>730</b>	<b>741</b>
Freight Class: 125						
<b>A1_RS3048H</b>	48" X 30" X 29.5"	Cubic Ft: 4.9	Ship Weight: 119	<b>640</b>	<b>650</b>	<b>659</b>
<b>A1_RS3042H</b>	42" X 30" X 29.5"	Cubic Ft: 4.9	Ship Weight: 104	<b>610</b>	<b>619</b>	<b>628</b>
<b>A1_RS3036H</b>	36" X 30" X 29.5"	Cubic Ft: 4.1	Ship Weight: 90	<b>578</b>	<b>587</b>	<b>595</b>
<b>A1_RS3030H</b>	30" X 30" X 29.5"	Cubic Ft: 4.1	Ship Weight: 75	<b>549</b>	<b>557</b>	<b>565</b>

### Left 30" Deep Rectangular Shell

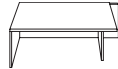
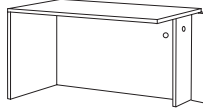

Support legs on 72", 66" and 60" lengths should be relocated inward (12" from either end) for increased worksurface support

- Full left, half right leg
- Grommet in half leg and modesty panel
- Connects with straight edge; not freestanding

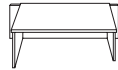

Support legs on 48", 42" and 36" and 30" lengths located close to ends

<b>A1_RS3072L</b>	72" X 30" X 29.5"	Cubic Ft: 7.2	Ship Weight: 176	<b>741</b>	<b>752</b>	<b>763</b>
Freight Class: 200						
<b>A1_RS3066L</b>	66" X 30" X 29.5"	Cubic Ft: 6.2	Ship Weight: 162	<b>719</b>	<b>730</b>	<b>741</b>
Freight Class: 200						
<b>A1_RS3060L</b>	60" X 30" X 29.5"	Cubic Ft: 6	Ship Weight: 148	<b>719</b>	<b>730</b>	<b>741</b>
Freight Class: 200						
<b>A1_RS3048L</b>	48" X 30" X 29.5"	Cubic Ft: 31	Ship Weight: 154	<b>640</b>	<b>650</b>	<b>659</b>
Freight Class: 200						
<b>A1_RS3042L</b>	42" X 30" X 29.5"	Cubic Ft: 27.2	Ship Weight: 142	<b>610</b>	<b>619</b>	<b>628</b>
Freight Class: 200						
<b>A1_RS3036L</b>	36" X 30" X 29.5"	Cubic Ft: 23.4	Ship Weight: 128	<b>578</b>	<b>587</b>	<b>595</b>
Freight Class: 200						
<b>A1_RS3030L</b>	30" X 30" X 29.5"	Cubic Ft: 19.8	Ship Weight: 118	<b>549</b>	<b>557</b>	<b>565</b>
Freight Class: 110						

TOP BASE FINISHES

ASPEN **AP** | NATURAL MAPLE **FM** | WINDSOR CHERRY **WC** | MAHOGANY **M** |

BASE ONLY FINISHES

GRAPHITE **GP** | GREY **G** | ESPRESSO **X** | MEDIUM OAK **O** | PEARWOOD **PW** | BLACK **E** | CLASSIC CHERRY **CC** |

SIN 711-2 **ATLAS**

Right 30" Deep Rectangular Shell

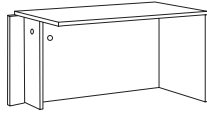

Support legs on 72", 66" and 60" lengths should be relocated inward (12" from either end) for increased worksurface support

- Full right, half left leg
- Grommet in half leg and modesty panel
- Connects with straight edge; not freestanding



Support legs on 48", 42" and 36" and 30" lengths located close to ends

Zone Pricing

1

2

3

Product Code	Dimensions	Cubic Ft.	Ship Weight	Zone 1	Zone 2	Zone 3
<b>A1_RS3072R</b>	72" X 30" X 29.5"	45.1	201	<b>741</b>	<b>752</b>	<b>763</b>
Freight Class: 200						
<b>A1_RS3066R</b>	66" X 30" X 29.5"	44.0	190	<b>719</b>	<b>730</b>	<b>741</b>
Freight Class: 200						
<b>A1_RS3060R</b>	60" X 30" X 29.5"	37.2	178	<b>719</b>	<b>730</b>	<b>741</b>
Freight Class: 200						
<b>A1_RS3048R</b>	48" X 30" X 29.5"	31.0	154	<b>640</b>	<b>650</b>	<b>659</b>
Freight Class: 200						
<b>A1_RS3042R</b>	42" X 30" X 29.5"	27.0	142	<b>610</b>	<b>619</b>	<b>628</b>
Freight Class: 200						
<b>A1_RS3036R</b>	36" X 30" X 29.5"	23.4	128	<b>578</b>	<b>587</b>	<b>595</b>
Freight Class: 200						
<b>A1_RS3030R</b>	30" X 30" X 29.5"	19.8	118	<b>549</b>	<b>557</b>	<b>565</b>
Freight Class: 110						

Shells 24" Deep

Freestanding 24" Deep Rectangular Shell

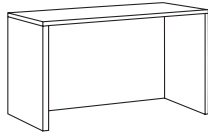

- Freestanding with two full legs
- Optional utility and mobile pedestals available

Product Code	Dimensions	Cubic Ft.	Ship Weight	Zone 1	Zone 2	Zone 3
<b>A1_RS2472</b>	72" X 24" X 29.5"	36.3	187	<b>697</b>	<b>707</b>	<b>718</b>
Freight Class: 200						
<b>A1_RS2466</b>	66" X 24" X 29.5"	33.4	173	<b>664</b>	<b>674</b>	<b>684</b>
Freight Class: 200						
<b>A1_RS2460</b>	60" X 24" X 29.5"	31.0	164	<b>649</b>	<b>659</b>	<b>668</b>
Freight Class: 200						
<b>A1_RS2448</b>	48" X 24" X 29.5"	24.7	141	<b>596</b>	<b>605</b>	<b>614</b>
Freight Class: 110						
<b>A1_RS2442</b>	42" X 24" X 29.5"	24.7	130	<b>564</b>	<b>572</b>	<b>581</b>
Freight Class: 110						
<b>A1_RS2436</b>	36" X 24" X 29.5"	19.1	118	<b>549</b>	<b>557</b>	<b>565</b>
Freight Class: 110						
<b>A1_RS2430</b>	30" X 24" X 29.5"	19.1	106	<b>523</b>	<b>531</b>	<b>539</b>
Freight Class: 110						

24" Deep Rectangular Shell/Bridge

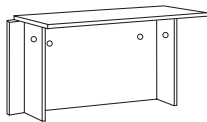

Support legs on 72", 66" and 60" lengths should be relocated inward (12" from either end) for increased worksurface support

- Connects at both ends
- Two half legs, not freestanding
- Two grommets in modesty panel, two in support legs
- Assembly required

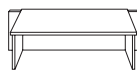

Support legs on 48", 42" and 36" and 30" lengths located close to ends

Product Code	Dimensions	Cubic Ft.	Ship Weight	Zone 1	Zone 2	Zone 3
<b>A1_RS2472H</b>	72" X 24" X 29.5"	5.8	167	<b>697</b>	<b>707</b>	<b>718</b>
<b>A1_RS2466H</b>	66" X 24" X 29.5"	5.4	152	<b>664</b>	<b>674</b>	<b>684</b>
<b>A1_RS2460H</b>	60" X 24" X 29.5"	4.9	139	<b>649</b>	<b>659</b>	<b>668</b>
<b>A1_RS2448H</b>	48" X 24" X 29.5"	3.9	112	<b>596</b>	<b>605</b>	<b>614</b>
<b>A1_RS2442H</b>	42" X 24" X 29.5"	3.5	99	<b>564</b>	<b>572</b>	<b>581</b>
<b>A1_RS2436H</b>	36" X 24" X 29.5"	3.0	85	<b>549</b>	<b>557</b>	<b>565</b>
<b>A1_RS2430H</b>	30" X 24" X 29.5"	3.0	71	<b>523</b>	<b>531</b>	<b>539</b>

Freight Class: 125

CONTEMPORARY LAMINATE



Zone Pricing	1	2	3
--------------	---	---	---

### Left 24" Deep Rectangular Shell

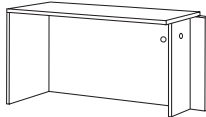

- Connects with straight edge; not freestanding
- Full left, half right leg
- Grommet in half leg and modesty panel



Support legs on 72", 66" and 60" lengths should be relocated inward (12" from either end) for increased worksurface support

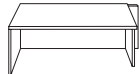

Support legs on 48", 42" and 36" and 30" lengths located close to ends

<b>A1_RS2472L</b> 72" X 24" X 29.5" Cubic Ft: 36.3 Ship Weight: 187	<b>697</b>	<b>707</b>	<b>718</b>
Freight Class: 200			
<b>A1_RS2466L</b> 66" X 24" X 29.5" Cubic Ft: 33.4 Ship Weight: 175	<b>664</b>	<b>674</b>	<b>684</b>
Freight Class: 200			
<b>A1_RS2460L</b> 60" X 24" X 29.5" Cubic Ft: 31.0 Ship Weight: 164	<b>649</b>	<b>659</b>	<b>668</b>
Freight Class: 200			
<b>A1_RS2448L</b> 48" X 24" X 29.5" Cubic Ft: 24.7 Ship Weight: 141	<b>596</b>	<b>605</b>	<b>614</b>
Freight Class: 110			
<b>A1_RS2442L</b> 42" X 24" X 29.5" Cubic Ft: 24.7 Ship Weight: 130	<b>564</b>	<b>572</b>	<b>581</b>
Freight Class: 200			
<b>A1_RS2436L</b> 36" X 24" X 29.5" Cubic Ft: 19.1 Ship Weight: 118	<b>549</b>	<b>557</b>	<b>565</b>
Freight Class: 110			
<b>A1_RS2430L</b> 30" X 24" X 29.5" Cubic Ft: 19.1 Ship Weight: 106	<b>523</b>	<b>531</b>	<b>539</b>
Freight Class: 110			

### Right 24" Deep Rectangular Shell

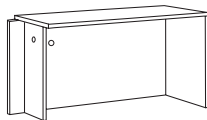

- Connects with straight edge; not freestanding
- Full right, half left leg
- Grommet in half leg and modesty panel

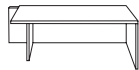

Support legs on 72", 66" and 60" lengths should be relocated inward (12" from either end) for increased worksurface support

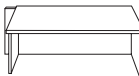

Support legs on 48", 42" and 36" and 30" lengths located close to ends

<b>A1_RS2472R</b> 72" X 24" X 29.5" Cubic Ft: 36.3 Ship Weight: 187	<b>697</b>	<b>707</b>	<b>718</b>
Freight Class: 200			
<b>A1_RS2466R</b> 66" X 24" X 29.5" Cubic Ft: 33.4 Ship Weight: 175	<b>664</b>	<b>674</b>	<b>684</b>
Freight Class: 200			
<b>A1_RS2460R</b> 60" X 24" X 29.5" Cubic Ft: 31.0 Ship Weight: 164	<b>649</b>	<b>659</b>	<b>668</b>
Freight Class: 200			
<b>A1_RS2448R</b> 48" X 24" X 29.5" Cubic Ft: 24.7 Ship Weight: 141	<b>596</b>	<b>605</b>	<b>614</b>
Freight Class: 110			
<b>A1_RS2442R</b> 42" X 24" X 29.5" Cubic Ft: 24.7 Ship Weight: 130	<b>564</b>	<b>572</b>	<b>581</b>
Freight Class: 200			
<b>A1_RS2436R</b> 36" X 24" X 29.5" Cubic Ft: 19.1 Ship Weight: 118	<b>549</b>	<b>557</b>	<b>565</b>
Freight Class: 110			
<b>A1_RS2430R</b> 30" X 24" X 29.5" Cubic Ft: 19.1 Ship Weight: 106	<b>523</b>	<b>531</b>	<b>539</b>
Freight Class: 110			

### 24" Deep Running Credenza Shell

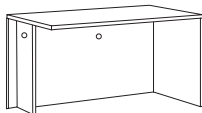

Freight Class: 200

- Connects with return/shell
- Use to create straight, continuous work area
- A1\_RR2472R - Full right, half left leg
- A1\_RR2472L - Full left, half right leg
- One grommet in modesty panel and one in support leg

<b>A1_RR2472R</b> 72" X 24" X 29.5" Cubic Ft: 36.3 Ship Weight: 167	<b>780</b>	<b>792</b>	<b>803</b>
<b>A1_RR2472L</b> 72" X 24" X 29.5" Cubic Ft: 36.3 Ship Weight: 167	<b>780</b>	<b>792</b>	<b>803</b>

Additional sizes available in Hyperwork section. Call for pricing.

### Modular Filing

#### Box/File Utility Pedestal



Freight Class: 100

- 3/4 height pedestal for field installation
- Pre-installed, black filing hardware
- Legal or letter filing
- Single-key locking on front

<b>H__UP QS</b> 15.75" X 22" X 17.75" Cubic Ft: 7 Ship Weight: 61	<b>575</b>	<b>584</b>	<b>592</b>
<b>Pulls:</b> Bright Brass <b>HB</b>   Brushed Chrome <b>HW</b>   Ebony <b>HE</b>   Oval Nickel <b>HD</b>			
<b>QS FINISHES</b> <b>FMGP</b>   <b>WC</b>   <b>QS PULLS</b> <b>W</b>			

TOP BASE FINISHES

ASPEN **AP** | NATURAL MAPLE **FM** | WINDSOR CHERRY **WC** | MAHOGANY **M** |

BASE ONLY FINISHES

GRAPHITE **GP** | GREY **G** | ESPRESSO **X** | MEDIUM OAK **O** | PEARWOOD **PW** | BLACK **E** | CLASSIC CHERRY **CC** |

SIN 711-2 **ATLAS**

Zone Pricing

1

2

3

Box/Box/File Utility Pedestal



- Full-to-floor pedestal for field installation
- Pre-installed, black filing hardware
- Legal or letter filing
- Single-key locking on front

Freight Class: 100

<b>H__UP2BF</b>	15.75" X 22" X 27.25"	Cubic Ft: 10.1	Ship Weight: 83	<b>694</b>	<b>704</b>	<b>715</b>
-----------------	-----------------------	----------------	-----------------	------------	------------	------------

<b>Pulls:</b>	Bright Brass <b>HB</b>	Brushed Chrome <b>HW</b>	Ebony <b>HE</b>	Oval Nickel <b>HD</b>
---------------	------------------------	--------------------------	-----------------	-----------------------

File/File Utility Pedestal



- Full-to-floor pedestal for field installation
- Pre-installed, black filing hardware
- Legal or letter filing
- Single-key locking on front

Freight Class: 100

<b>H__UPF</b>	15.75" X 22" X 27.25"	Cubic Ft: 10.1	Ship Weight: 83	<b>694</b>	<b>704</b>	<b>715</b>
---------------	-----------------------	----------------	-----------------	------------	------------	------------

<b>Pulls:</b>	Bright Brass <b>HB</b>	Brushed Chrome <b>HW</b>	Ebony <b>HE</b>	Oval Nickel <b>HD</b>
---------------	------------------------	--------------------------	-----------------	-----------------------

Lateral Pedestal Reception Desk



- Full-to-floor pedestal for field installation
- Pre-installed, black filing hardware
- Legal or letter filing
- Single-key locking on front

Freight Class: 100

<b>H__ULF</b>	30.5" X 22" X 27.25"	Cubic Ft: 19.8	Ship Weight: 165	<b>872</b>	<b>885</b>	<b>898</b>
---------------	----------------------	----------------	------------------	------------	------------	------------

<b>Pulls:</b>	Bright Brass <b>HB</b>	Brushed Chrome <b>HW</b>	Ebony <b>HE</b>	Oval Nickel <b>HD</b>
---------------	------------------------	--------------------------	-----------------	-----------------------

Reception Stations

Left Pedestal Reception Desk

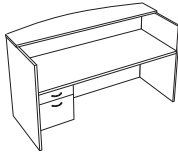

- 42" privacy height
- 18" Bow front transaction counter field installed
- Box/File left pedestal
- Pre-installed, black filing hardware
- Legal or letter filing
- Single-key side locking pedestal

Freight Class: 110

<b>A1__7230L</b>	72" X 36" X 42.5"	Cubic Ft: 64.4	Ship Weight: 373	<b>1717</b>	<b>1743</b>	<b>1769</b>
------------------	-------------------	----------------	------------------	-------------	-------------	-------------

<b>Center Drawer C</b>	165	167	170
------------------------	-----	-----	-----

<b>Keyboard Platform K</b>	196	199	202
----------------------------	-----	-----	-----

<b>Pulls:</b>	Bright Brass <b>A1B</b>	Brushed Chrome <b>A1W</b>	Ebony <b>A1E</b>	Oval Nickel <b>A1D</b>
---------------	-------------------------	---------------------------	------------------	------------------------

Right Pedestal Reception Desk

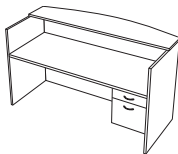

- Same description as above except:
- Box/File right pedestal

Freight Class: 110

<b>A1__7230R</b>	72" X 36" X 42.5"	Cubic Ft: 64.4	Ship Weight: 373	<b>1717</b>	<b>1743</b>	<b>1769</b>
------------------	-------------------	----------------	------------------	-------------	-------------	-------------

<b>Center Drawer C</b>	165	167	170
------------------------	-----	-----	-----

<b>Keyboard Platform K</b>	196	199	202
----------------------------	-----	-----	-----

<b>Pulls:</b>	Bright Brass <b>A1B</b>	Brushed Chrome <b>A1W</b>	Ebony <b>A1E</b>	Oval Nickel <b>A1D</b>
---------------	-------------------------	---------------------------	------------------	------------------------

Left Pedestal Reception Return

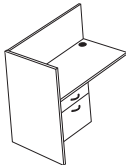

- 41" privacy height
- Box/File left pedestal
- Pre-installed, black filing hardware
- Legal or letter filing
- Grommet in modesty panel
- Single-key side locking pedestal

Freight Class: 110

<b>A1__2442L</b>	42" X 24" X 41"	Cubic Ft: 32.9	Ship Weight: 205	<b>1140</b>	<b>1157</b>	<b>1174</b>
------------------	-----------------	----------------	------------------	-------------	-------------	-------------

<b>Keyboard Platform K</b>	196	199	202
----------------------------	-----	-----	-----

<b>Pulls:</b>	Bright Brass <b>A1B</b>	Brushed Chrome <b>A1W</b>	Ebony <b>A1E</b>	Oval Nickel <b>A1D</b>
---------------	-------------------------	---------------------------	------------------	------------------------

Right Pedestal Reception Return

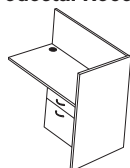

- Same description as above except:
- Box/File left pedestal

Freight Class: 110

<b>A1__2442R</b>	42" X 36" X 41"	Cubic Ft: 32.9	Ship Weight: 205	<b>1140</b>	<b>1157</b>	<b>1174</b>
------------------	-----------------	----------------	------------------	-------------	-------------	-------------

<b>Keyboard Platform K</b>	196	199	202
----------------------------	-----	-----	-----

<b>Pulls:</b>	Bright Brass <b>A1B</b>	Brushed Chrome <b>A1W</b>	Ebony <b>A1E</b>	Oval Nickel <b>A1D</b>
---------------	-------------------------	---------------------------	------------------	------------------------

CONTEMPORARY LAMINATE



A1 W AP 7230L2  
 Pull      Finish

Zone Pricing	1	2	3
--------------	---	---	---

### Left Pedestal Reception Desk

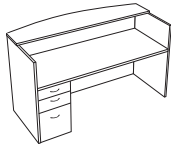

Freight Class: 110

- 42" privacy height
- 18" Bow front transaction counter (field installed)
- Box/Box/File left pedestal
- Pre-installed, black filing hardware
- Legal or letter filing
- Single-key side locking pedestal

<b>A1_7230L2</b> 72" X 36" X 42.5" Cubic Ft: 64.4 Ship Weight: 398	<b>1991</b>	<b>2021</b>	<b>2051</b>
<b>Center Drawer C</b>	165	167	170
<b>Keyboard Platform K</b>	196	199	202

**Pulls:** Bright Brass **A1B** | Brushed Chrome **A1W** | Ebony **A1E** | Oval Nickel **A1D**

### Right Pedestal Reception Desk

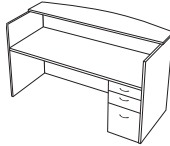

Freight Class: 110

- Same description as above except:
- Box/Box/File right pedestal

<b>A1_7230R2</b> 72" X 36" X 42.5" Cubic Ft: 64.4 Ship Weight: 398	<b>1991</b>	<b>2021</b>	<b>2051</b>
<b>Center Drawer C</b>	165	167	170
<b>Keyboard Platform K</b>	196	199	202

**Pulls:** Bright Brass **A1B** | Brushed Chrome **A1W** | Ebony **A1E** | Oval Nickel **A1D**

### Left Full Pedestal Reception Return

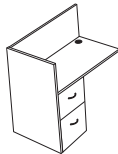

Freight Class: 110

- 41" privacy height
- File/File left pedestal
- Pre-installed, black filing hardware
- Legal or letter filing
- Grommet in top and modesty panel
- Single-key side locking pedestal

<b>A1_2442LF</b> 42" X 24" X 41" Cubic Ft: 32.9 Ship Weight: 230	<b>1314</b>	<b>1334</b>	<b>1353</b>
<b>Keyboard Platform K</b>	196	199	202

**Pulls:** Bright Brass **A1B** | Brushed Chrome **A1W** | Ebony **A1E** | Oval Nickel **A1D**

### Right Full Pedestal Reception Return



Freight Class: 110

- Same description as above except:
- File/File right pedestal

<b>A1_2442RF</b> 42" X 24" X 41" Cubic Ft: 32.9 Ship Weight: 230	<b>1314</b>	<b>1334</b>	<b>1353</b>
<b>Keyboard Platform K</b>	196	199	202

**Pulls:** Bright Brass **A1B** | Brushed Chrome **A1W** | Ebony **A1E** | Oval Nickel **A1D**

### Reception Screen for Main

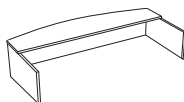

Freight Class: 70

- Fits 72" x 30" desks
- 18" Bow front transaction corner
- Non-skid rubber strips on bottom prohibit movement

<b>A1_710</b> 72" X 36" X 14.5" Cubic Ft: 28.9 Ship Weight: 145	<b>1013</b>	<b>1028</b>	<b>1043</b>
---	-------------	-------------	-------------

### Reception Screen for Return

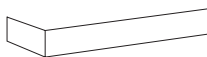

Freight Class: 70

- Fits 42" x 24" executive height return
- Hardware included to join to main reception screen
- A1\_611L fits left return
- A1\_611R fits right return
- Assembly required

<b>A1_611L</b> 42" X 24" X 13" Cubic Ft: 1.5 Ship Weight: 27	<b>213</b>	<b>216</b>	<b>219</b>
<b>A1_611R</b> 42" X 24" X 13" Cubic Ft: 1.5 Ship Weight: 27	<b>213</b>	<b>216</b>	<b>219</b>

## Overhead Storage

### Overhead Storage Unit

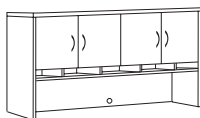

Freight Class: 125

- Two storage compartments
- Four doors
- Five paper storage shelves
- 18.5" monitor clearance under cabinet
- Grommet in back panel

<b>A1_738 QS</b> 72" X 16" X 37" Cubic Ft: 33.6 Ship Weight: 252	<b>1623</b>	<b>1647</b>	<b>1672</b>
<b>Task Light T</b>	124	126	128
<b>LED Task Light L</b>	212	215	218

<b>A1_678</b> 66" X 16" X 37" Cubic Ft: 28.3 Ship Weight: 226	<b>1391</b>	<b>1412</b>	<b>1433</b>
<b>Task Light T</b>	124	126	128
<b>LED Task Light L</b>	212	215	218

<b>A1_676</b> 60" X 16" X 37" Cubic Ft: 28.3 Ship Weight: 210	<b>1374</b>	<b>1395</b>	<b>1415</b>
<b>Task Light T</b>	124	126	128
<b>LED Task Light L</b>	212	215	218

**Pulls:** Bright Brass **A1B** | Brushed Chrome **A1W** | Ebony **A1E** | Oval Nickel **A1D**

**Locks:** \$150\_Y | **QS FINISHES** **FMGP** **WC** | **QS PULLS** **W**



TOP BASE FINISHES

ASPEN **AP** | NATURAL MAPLE **FM** | WINDSOR CHERRY **WC** | MAHOGANY **M** |

BASE ONLY FINISHES

GRAPHITE **GP** | GREY **G** | ESPRESSO **X** | MEDIUM OAK **O** | PEARWOOD **PW** | BLACK **E** | CLASSIC CHERRY **CC** |

SIN 711-2 **ATLAS**

Overhead Storage Unit

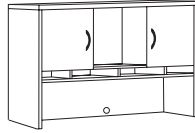

- Two storage compartments with doors
- Center open storage
- Four paper storage shelves
- 18.5" monitor clearance under cabinet
- Grommet in back panel

Freight Class: 125

Overhead Storage Unit



- One storage compartment
- Two doors
- Three paper storage shelves
- 18.5" monitor clearance under cabinet
- Grommet in back panel

Freight Class: 125

Overhead Storage Unit

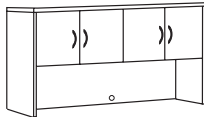

- Two storage compartments
- Four doors
- 21" monitor clearance under cabinet
- Grommet in back panel

Freight Class: 125

Overhead Storage Unit

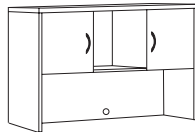

- Two storage compartments with doors
- Center open storage
- 21" monitor clearance under cabinet
- Grommet in back panel

Freight Class: 125

Overhead Storage Unit

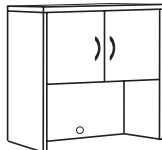

- One storage compartment
- Two doors
- 21" monitor clearance under cabinet
- Grommet in back panel

Freight Class: 125

		Zone Pricing	1	2	3
<b>A1_478</b>	48" X 16" X 37" Cubic Ft: 24.3 Ship Weight: 191	<b>1118</b>	<b>1135</b>	<b>1152</b>	
	Task Light <b>T</b>	124	126	128	
	LED Task Light <b>L</b>	212	215	218	
<b>Pulls:</b>	Bright Brass <b>A1B</b>   Brushed Chrome <b>A1W</b>   Ebony <b>A1E</b>   Oval Nickel <b>A1D</b>				
<b>Locks:</b>	\$150_Y				
<b>A1_476</b>	42" X 16" X 37" Cubic Ft: 24.3 Ship Weight: 170	<b>1048</b>	<b>1064</b>	<b>1079</b>	
	Task Light <b>T</b>	124	126	128	
	LED Task Light <b>L</b>	212	215	218	
<b>A1_338</b>	36" X 16" X 37" Cubic Ft: 15.3 Ship Weight: 151	<b>1015</b>	<b>1030</b>	<b>1045</b>	
	Task Light <b>T</b>	124	126	128	
	LED Task Light <b>L</b>	212	215	218	
<b>A1_336</b>	30" X 16" X 37" Cubic Ft: 15.3 Ship Weight: 145	<b>960</b>	<b>974</b>	<b>989</b>	
	Task Light <b>T</b>	124	126	128	
	LED Task Light <b>L</b>	212	215	218	
<b>Pulls:</b>	Bright Brass <b>A1B</b>   Brushed Chrome <b>A1W</b>   Ebony <b>A1E</b>   Oval Nickel <b>A1D</b>				
<b>Locks:</b>	\$75_Y				
<b>A1_737 QS</b>	72" X 16" X 37" Cubic Ft: 33.6 Ship Weight: 233	<b>1289</b>	<b>1308</b>	<b>1328</b>	
	Task Light <b>T</b>	124	126	128	
	LED Task Light <b>L</b>	212	215	218	
<b>A1_677</b>	66" X 16" X 37" Cubic Ft: 28.3 Ship Weight: 209	<b>1056</b>	<b>1072</b>	<b>1088</b>	
	Task Light <b>T</b>	124	126	128	
	LED Task Light <b>L</b>	212	215	218	
<b>A1_675</b>	60" X 16" X 37" Cubic Ft: 28.3 Ship Weight: 190	<b>1013</b>	<b>1028</b>	<b>1043</b>	
	Task Light <b>T</b>	124	126	128	
	LED Task Light <b>L</b>	212	215	218	
<b>Pulls:</b>	Bright Brass <b>A1B</b>   Brushed Chrome <b>A1W</b>   Ebony <b>A1E</b>   Oval Nickel <b>A1D</b>				
<b>Locks:</b>	\$150_Y   <b>QS FINISHES</b> <b>FMGP</b>   <b>WC</b>   <b>QS PULLS</b> <b>W</b>				
<b>A1_477</b>	48" X 16" X 37" Cubic Ft: 24.3 Ship Weight: 171	<b>820</b>	<b>832</b>	<b>845</b>	
	Task Light <b>T</b>	124	126	128	
	LED Task Light <b>L</b>	212	215	218	
<b>Pulls:</b>	Bright Brass <b>A1B</b>   Brushed Chrome <b>A1W</b>   Ebony <b>A1E</b>   Oval Nickel <b>A1D</b>				
<b>Locks:</b>	\$150_Y				
<b>A1_475</b>	42" X 16" X 37" Cubic Ft: 24.3 Ship Weight: 150	<b>770</b>	<b>782</b>	<b>793</b>	
	Task Light <b>T</b>	124	126	128	
	LED Task Light <b>L</b>	212	215	218	
<b>A1_337</b>	36" X 16" X 37" Cubic Ft: 28.3 Ship Weight: 131	<b>716</b>	<b>727</b>	<b>737</b>	
	Task Light <b>T</b>	124	126	128	
	LED Task Light <b>L</b>	212	215	218	
<b>A1_335</b>	30" X 16" X 37" Cubic Ft: 15.3 Ship Weight: 125	<b>625</b>	<b>634</b>	<b>644</b>	
	Task Light <b>T</b>	124	126	128	
	LED Task Light <b>L</b>	212	215	218	
<b>Pulls:</b>	Bright Brass <b>A1B</b>   Brushed Chrome <b>A1W</b>   Ebony <b>A1E</b>   Oval Nickel <b>A1D</b>				
<b>Locks:</b>	\$75_Y				

CONTEMPORARY LAMINATE



A1 AP 718  
Finish

**Open Overhead Storage Unit**

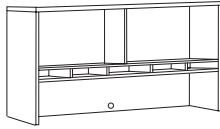

- Two cabinet compartments
- Five paper storage shelves
- 18.5" monitor clearance under cabinet
- Grommet in back panel

Freight Class: 125

		Zone Pricing	1	2	3
<b>A1_718</b>	72" X 16" X 37" Cubic Ft: 33.6 Ship Weight: 212		<b>1459</b>	<b>1481</b>	<b>1503</b>
	<b>Task Light T</b>		124	126	128
	<b>LED Task Light L</b>		212	215	218
<b>A1_618</b>	66" X 16" X 37" Cubic Ft: 28.3 Ship Weight: 189		<b>1099</b>	<b>1115</b>	<b>1132</b>
	<b>Task Light T</b>		124	126	128
	<b>LED Task Light L</b>		212	215	218
<b>A1_616</b>	60" X 16" X 37" Cubic Ft: 28.3 Ship Weight: 170		<b>1074</b>	<b>1090</b>	<b>1106</b>
	<b>Task Light T</b>		124	126	128
	<b>LED Task Light L</b>		212	215	218

**Open Overhead Storage Unit**

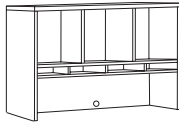

- Three cabinet compartments
- Four paper storage shelves
- 18.5" monitor clearance under cabinet
- Grommet in back panel

Freight Class: 125

<b>A1_418</b>	48" X 16" X 37" Cubic Ft: 24.3 Ship Weight: 166		<b>938</b>	<b>952</b>	<b>966</b>
	<b>Task Light T</b>		124	126	128
	<b>LED Task Light L</b>		212	215	218

**Open Overhead Storage Unit**



- One cabinet compartment
- Three paper storage shelves
- 18.5" monitor clearance under cabinet
- Grommet in back panel

Freight Class: 125

<b>A1_416</b>	42" X 16" X 37" Cubic Ft: 24.3 Ship Weight: 147		<b>867</b>	<b>880</b>	<b>893</b>
	<b>Task Light T</b>		124	126	128
	<b>LED Task Light L</b>		212	215	218
<b>A1_318</b>	36" X 16" X 37" Cubic Ft: 15.3 Ship Weight: 131		<b>853</b>	<b>866</b>	<b>879</b>
	<b>Task Light T</b>		124	126	128
	<b>LED Task Light L</b>		212	215	218
<b>A1_316</b>	30" X 16" X 37" Cubic Ft: 15.3 Ship Weight: 125		<b>837</b>	<b>850</b>	<b>862</b>
	<b>Task Light T</b>		124	126	128
	<b>LED Task Light L</b>		212	215	218

**Open Overhead Storage Unit**

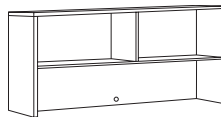

- Two cabinet compartments
- 21" monitor clearance under cabinet
- Grommet in back panel

Freight Class: 125

<b>A1_717</b>	72" X 16" X 37" Cubic Ft: 33.6 Ship Weight: 193		<b>1032</b>	<b>1047</b>	<b>1063</b>
	<b>Task Light T</b>		124	126	128
	<b>LED Task Light L</b>		212	215	218
<b>A1_617</b>	66" X 16" X 37" Cubic Ft: 28.3 Ship Weight: 169		<b>740</b>	<b>751</b>	<b>762</b>
	<b>Task Light T</b>		124	126	128
	<b>LED Task Light L</b>		212	215	218
<b>A1_615</b>	60" X 16" X 37" Cubic Ft: 28.3 Ship Weight: 150		<b>702</b>	<b>713</b>	<b>723</b>
	<b>Task Light T</b>		124	126	128
	<b>LED Task Light L</b>		212	215	218

**Open Overhead Storage Unit**

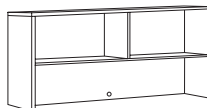

- Two cabinet compartments
- 21" monitor clearance under cabinet
- Grommet in back panel

Freight Class: 125

<b>A1_417</b>	48" X 16" X 37" Cubic Ft: 24.3 Ship Weight: 146		<b>649</b>	<b>659</b>	<b>668</b>
	<b>Task Light T</b>		124	126	128
	<b>LED Task Light L</b>		212	215	218

TOP BASE FINISHES

ASPEN **AP** | NATURAL MAPLE **FM** | WINDSOR CHERRY **WC** | MAHOGANY **M** |

BASE ONLY FINISHES

GRAPHITE **GP** | GREY **G** | ESPRESSO **X** | MEDIUM OAK **O** | PEARWOOD **PW** | BLACK **E** | CLASSIC CHERRY **CC** |

SIN 711-2 **ATLAS**

Open Overhead Storage Unit

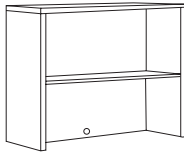

- Storage compartment
- 21" monitor clearance under cabinet
- Grommet in back panel

Freight Class: 125

Overhead Bookcase

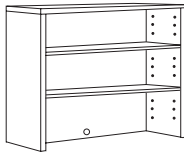

- 2 adjustable 1" thick shelves
- Fits 36" lateral file, multifile or two-door storage cabinet

Freight Class: 125

Storage & Filing

Mobility Pedestal



- Fits under work surface
- Box/Box/File pedestal
- Pre-installed, black filing hardware
- Legal or letter filing
- Single-key front locking
- Four casters, two locking
- See additional mobile pedestals in Hyperwork section

Freight Class: 100

Compact Organizer

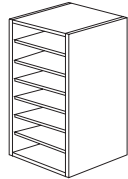

- Rests on credenza, return, etc.
- Fits beneath overheads without paper storage
- Five pullout paper shelves
- One pullout accessory tray with tape dispenser
- Specify finish only

Freight Class: 100

Two-Drawer Lateral File



- Two lateral file drawers, legal or letter filing
- Pre-installed black filing hardware
- Front locking
- Anti-tilt counterweight standard
- Hardwood bottom support rail secured with metal bracket at each end

Freight Class: 100

MultiFile

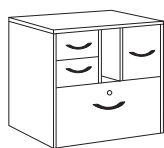

- Lateral file drawer with lock
- File drawer
- Two box drawers
- Hot projects access slot
- Pre-installed black filing hardware
- Legal or letter filing

Freight Class: 125

		Zone Pricing	1	2	3
<b>A1_415</b>	42" X 16" X 37" Cubic Ft: 24.3 Ship Weight: 130		<b>565</b>	<b>573</b>	<b>582</b>
	<b>Task Light I</b>		124	126	128
	<b>LED Task Light L</b>		212	215	218
<b>A1_317</b>	36" X 16" X 37" Cubic Ft: 15.3 Ship Weight: 111		<b>529</b>	<b>537</b>	<b>545</b>
	<b>Task Light I</b>		124	126	128
	<b>LED Task Light L</b>		212	215	218
<b>A1_315</b>	30" X 16" X 37" Cubic Ft: 15.3 Ship Weight: 105		<b>467</b>	<b>474</b>	<b>481</b>
	<b>Task Light I</b>		124	126	128
	<b>LED Task Light L</b>		212	215	218

<b>A1_319</b>	36" X 16" X 37" Cubic Ft: 15.3 Ship Weight: 125		<b>712</b>	<b>723</b>	<b>733</b>
---------------	---	--	------------	------------	------------

<b>H_212BF</b>	16" X 22.25" X 27.25" Cubic Ft: 10.3 Ship Weight: 125		<b>856</b>	<b>869</b>	<b>882</b>
----------------	---	--	------------	------------	------------

<b>HW_CO</b>	11" X 13" X 20" Cubic Ft: 2.1 Ship Weight: 40		<b>329</b>	<b>334</b>	<b>339</b>
--------------	---	--	------------	------------	------------

<b>A1_346 QS</b>	36.5" X 24" X 29.5" Cubic Ft: 19.8 Ship Weight: 194		<b>1188</b>	<b>1206</b>	<b>1224</b>
------------------	---	--	-------------	-------------	-------------

<b>Pulls:</b>	Bright Brass <b>A1B</b>	Brushed Chrome <b>A1W</b>	Ebony <b>A1E</b>	Oval Nickel <b>A1D</b>
---------------	-------------------------	---------------------------	------------------	------------------------

<b>EXTRA THICK BOTTOM</b>	\$160 H
---------------------------	---------

<b>QS FINISHES</b>	<b>FMGP</b>	<b>WC</b>	<b>QS PULLS</b>	<b>W</b>
--------------------	-------------	-----------	-----------------	----------

<b>A1_735</b>	36.5" X 24" X 29.5" Cubic Ft: 19.8 Ship Weight: 205		<b>1192</b>	<b>1210</b>	<b>1228</b>
---------------	---	--	-------------	-------------	-------------

<b>Pulls:</b>	Bright Brass <b>A1B</b>	Brushed Chrome <b>A1W</b>	Ebony <b>A1E</b>	Oval Nickel <b>A1D</b>
---------------	-------------------------	---------------------------	------------------	------------------------

<b>EXTRA THICK BOTTOM</b>	\$80 H
---------------------------	--------

CONTEMPORARY LAMINATE

A1	W	AP	732
	Pull		Finish

Zone Pricing	1	2	3
--------------	---	---	---

### Two-Door Storage Cabinet

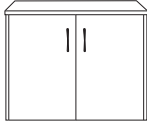

Freight Class: 125

- Two hinged drawers
- One adjustable shelf
- Leveling glides
- Inside dimensions: 34" x 21" x 24"

<b>A1_732</b>	36.5" X 24" X 29.5"	Cubic Ft: 19.8	Ship Weight: 141	<b>946</b>	<b>960</b>	<b>974</b>
---------------	---------------------	----------------	------------------	------------	------------	------------

<b>Pulls:</b>	Bright Brass <b>A1B</b>	Brushed Chrome <b>A1W</b>	Ebony <b>A1E</b>	Oval Nickel <b>A1D</b>
---------------	-------------------------	---------------------------	------------------	------------------------

### Four-Drawer Lateral File



Freight Class: 100

- Four lateral file drawers, legal or letter filing
- Pre-installed black filing hardware
- Central locking (lock on front)
- Anti-tilt mechanism prevents more than one drawer opening at a time
- Hardwood bottom support rail secured with metal bracket at each end

<b>A1_426</b>	30.75" X 20.75" X 57.25"	Cubic Ft: 27.9	Ship Weight: 259	<b>2223</b>	<b>2256</b>	<b>2290</b>
---------------	--------------------------	----------------	------------------	-------------	-------------	-------------

<b>Pulls:</b>	Bright Brass <b>A1B</b>	Brushed Chrome <b>A1W</b>	Ebony <b>A1E</b>	Oval Nickel <b>A1D</b>
---------------	-------------------------	---------------------------	------------------	------------------------

<b>EXTRA THICK BOTTOM</b>	\$320 <b>H</b>
---------------------------	----------------

### Three-Drawer Lateral File



Freight Class: 100

- Three lateral file drawers, legal or letter filing
- Pre-installed black filing hardware
- Central locking (lock on front)
- Anti-tilt mechanism prevents more than one drawer opening at a time
- Hardwood bottom support rail secured with metal bracket at each end

<b>A1_3036</b>	30.75" X 20.75" X 57.25"	Cubic Ft: 27.9	Ship Weight: 202	<b>1573</b>	<b>1597</b>	<b>1620</b>
----------------	--------------------------	----------------	------------------	-------------	-------------	-------------

<b>Pulls:</b>	Bright Brass <b>A1B</b>	Brushed Chrome <b>A1W</b>	Ebony <b>A1E</b>	Oval Nickel <b>A1D</b>
---------------	-------------------------	---------------------------	------------------	------------------------

<b>EXTRA THICK BOTTOM</b>	\$240 <b>H</b>
---------------------------	----------------

### Storage Cabinet



Freight Class: 125

- Storage compartment 34" x 19.625" x 34"
- Two adjustable shelves in storage compartment
- Two lateral file drawers, legal or letter filing
- Front-locking file cabinet
- Hardwood bottom support rail secured with metal bracket at each end

<b>A1_65STOR QS</b>	36" X 24" X 66.5"	Cubic Ft: 43.1	Ship Weight: 309	<b>1915</b>	<b>1944</b>	<b>1972</b>
---------------------	-------------------	----------------	------------------	-------------	-------------	-------------

<b>Pulls:</b>	Bright Brass <b>A1B</b>	Brushed Chrome <b>A1W</b>	Ebony <b>A1E</b>	Oval Nickel <b>A1D</b>
---------------	-------------------------	---------------------------	------------------	------------------------

<b>EXTRA THICK BOTTOM</b>	\$160 <b>H</b>
---------------------------	----------------

<b>QS FINISHES</b>	<b>FMGP</b>	<b>WC</b>	<b>QS PULLS</b>	<b>W</b>
--------------------	-------------	-----------	-----------------	----------

### Wardrobe

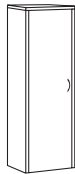

Freight Class: 125

- Coat rod mounted side-to-side
- Adjustable shelf near bottom
- A1\_65WDL - Hinge on left
- A1\_65WDR - Hinge on right

<b>A1_65WDL</b>	24" X 24" X 66.5"	Cubic Ft: 31.6	Ship Weight: 134	<b>1522</b>	<b>1545</b>	<b>1568</b>
-----------------	-------------------	----------------	------------------	-------------	-------------	-------------

<b>A1_65WDR</b>	24" X 24" X 66.5"	Cubic Ft: 31.6	Ship Weight: 134	<b>1522</b>	<b>1545</b>	<b>1568</b>
-----------------	-------------------	----------------	------------------	-------------	-------------	-------------

<b>Pulls:</b>	Bright Brass <b>A1B</b>	Brushed Chrome <b>A1W</b>	Ebony <b>A1E</b>	Oval Nickel <b>A1D</b>
---------------	-------------------------	---------------------------	------------------	------------------------

### Five Shelf Bookcase

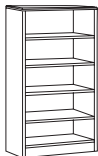

Freight Class: 125

- 84" = 5 adjustable shelves
- 72" = 4 adjustable shelves
- 60" = 3 adjustable shelves
- Bottom shelf fixed
- All shelves 1" thick
- Back panel finished one side

<b>A1_84</b>	36" X 12" X 84.5"	Cubic Ft: 28.6	Ship Weight: 182	<b>1072</b>	<b>1088</b>	<b>1104</b>
--------------	-------------------	----------------	------------------	-------------	-------------	-------------

<b>A1_72</b>	36" X 12" X 72.5"	Cubic Ft: 24.7	Ship Weight: 154	<b>1002</b>	<b>1017</b>	<b>1032</b>
--------------	-------------------	----------------	------------------	-------------	-------------	-------------

<b>A1_60</b>	36" X 12" X 60.5"	Cubic Ft: 20.7	Ship Weight: 125	<b>883</b>	<b>896</b>	<b>909</b>
--------------	-------------------	----------------	------------------	------------	------------	------------

### Three Shelf Bookcase



Freight Class: 125

- Two adjustable shelves
- Bottom shelf fixed
- All shelves 1" thick
- Back panel finished one side

<b>A1_48</b>	36" X 12" X 48.5"	Cubic Ft: 16.8	Ship Weight: 107	<b>645</b>	<b>655</b>	<b>664</b>
--------------	-------------------	----------------	------------------	------------	------------	------------

<b>A1_36</b>	36" X 12" X 36.5"	Cubic Ft: 12.5	Ship Weight: 89	<b>605</b>	<b>614</b>	<b>623</b>
--------------	-------------------	----------------	-----------------	------------	------------	------------

TOP BASE FINISHES

ASPEN **AP** | NATURAL MAPLE **FM** | WINDSOR CHERRY **WC** | MAHOGANY **M** |

BASE ONLY FINISHES

GRAPHITE **GP** | GREY **G** | ESPRESSO **X** | MEDIUM OAK **O** | PEARWOOD **PW** | BLACK **E** | CLASSIC CHERRY **CC** |

SIN 711-2 **ATLAS**

**Five Shelf Bookcase**

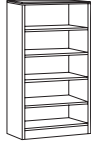

- Three adjustable shelves
- Bottom and second-from-bottom shelves fixed
- All shelves 1" thick
- Back panel 3/4" thick, finished both sides

Freight Class: 125

		Zone Pricing		
		1	2	3
<b>A1_65</b>	<b>QS</b> 36" X 16" X 66.5" Cubic Ft: 28.9 Ship Weight: 212	<b>892</b>	<b>905</b>	<b>919</b>
<b>QS FINISHES</b> <b>FMGP</b> <b>WC</b>				

**Bookcase with Doors**



- Two door storage area
- One adjustable and one fixed shelf behind doors
- Two adjustable and one fixed shelf above doors
- 1" thick shelves
- Back panel 3/4" thick, finished both sides

Freight Class: 125

<b>A1_652D</b>	36" X 16" X 66.5" Cubic Ft: 28.9 Ship Weight: 232	<b>1204</b>	<b>1222</b>	<b>1240</b>
<b>Pulls:</b> Bright Brass <b>A1B</b>   Brushed Chrome <b>A1W</b>   Ebony <b>A1E</b>   Oval Nickel <b>A1D</b>				

**Curved Corner Bookcase, 66.5" High**

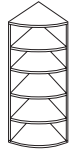

- Fits in corner at end of workstation
- Five shelf storage
- Four adjustable shelves
- Bottom shelf fixed
- 1" thick shelves
- AdvantEdge front edge

Freight Class: 125

<b>A1_CB65</b>	24" X 24" X 66.5" Cubic Ft: 31.6 Ship Weight: 192	<b>1087</b>	<b>1103</b>	<b>1120</b>
----------------	---	-------------	-------------	-------------

**Curved Corner Bookcase, 29" High**



- Fits in corner of workstation
- Middle shelf adjustable
- 1" thick shelves
- AdvantEdge front edge

Freight Class: 125

<b>A1_CB29</b>	24" X 24" X 29.5" Cubic Ft: 20 Ship Weight: 123	<b>952</b>	<b>966</b>	<b>981</b>
----------------	---	------------	------------	------------

**Conference Room Accessories**

**Mobile Audio/Visual Cabinet**



- Full-opening doors
- Upper/lower locks
- Up to 29", 150-lb. TV
- Pull out 360 degree swivel TV shelf
- Adjustable DVD shelf at top
- Two adjustable shelves in bottom
- Shelf & back grommets
- 400 lb. capacity
- Handhold for easy movement
- Casters for mobility

Freight Class: 125

<b>A1_65AV</b>	36.5" X 24" X 66.5" Cubic Ft: 43.1 Ship Weight: 309	<b>2619</b>	<b>2658</b>	<b>2698</b>
<b>Pulls:</b> Bright Brass <b>A1B</b>   Brushed Chrome <b>A1W</b>   Ebony <b>A1E</b>   Oval Nickel <b>A1D</b>				

**Mobile Media Stand**

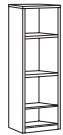

- Three adjustable shelves
- Cords drop behind shelves
- Grommets in back for wire management
- Casters for mobility
- Hand hold for easy movement

Freight Class: 125

<b>A1_MMS</b>	24" X 24" X 66.5" Cubic Ft: 31.6 Ship Weight: 136	<b>1317</b>	<b>1337</b>	<b>1357</b>
---------------	---	-------------	-------------	-------------

**Mobile Height-Adjustable Pie Shaped Table**



- Pie-shaped top
- 10" pneumatic height adjustment for standing or sitting work area
- Five-star base with locking casters
- Freestanding

Freight Class: 125

<b>A1_ET24</b>	24" X 28" X 23.5-33.5" Cubic Ft: 16.7 Ship Weight: 46	<b>910</b>	<b>924</b>	<b>937</b>
<b>A1_ET30</b>	30" X 35" X 23.5-33.5" Cubic Ft: 16.7 Ship Weight: 58	<b>955</b>	<b>969</b>	<b>984</b>

**Mobile Height-Adjustable Bullet Shape Table**



- Bullet-shaped top
- 10" pneumatic height adjustment for standing or sitting work area
- Five-star base with locking casters
- Freestanding

Freight Class: 125

<b>A1_MT24</b>	28" X 24" X 23.5-33.5" Cubic Ft: 16.7 Ship Weight: 50	<b>770</b>	<b>782</b>	<b>793</b>
<b>A1_MT30</b>	30" X 28" X 23.5-33.5" Cubic Ft: 16.7 Ship Weight: 66	<b>843</b>	<b>856</b>	<b>868</b>

CONTEMPORARY LAMINATE

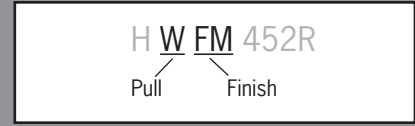

## CHARACTERISTICS

Hyperwork modular casegoods offer extensive choice for design flexibility, adapting to various building layouts, business structures and personal work requirements. The details below will help you understand the key components of Hyperwork.

## FINISHES

— ALL COLORS ARE THE SAME PRICE — All finishes are thermally fused laminates unless otherwise noted. **A high pressure laminate top option is available for a 15% pricing upcharge and a six-week lead time will apply.** High pressure laminate tops are only offered in **Windsor Cherry, Mahogany and Grey.** Contact your customer service representative to discuss specific high pressure laminate needs and to obtain delivery quotes. To order high-pressure laminate tops on Hyperwork items in Windsor Cherry, Mahogany or Grey, add 4 after the H and add 15% to the list price of the item.

*Example:* H4WM720

## FINISH COLORS

<b>AP</b> Aspen	<b>PW</b> Pearwood
<b>E</b> Black	<b>WC</b> Windsor Cherry
<b>FM</b> Natural Maple	<b>G</b> Grey
<b>GP</b> Graphite	<b>X</b> Espresso
<b>M</b> Mahogany	<b>CC</b> Classic Cherry
<b>O</b> Medium Oak	

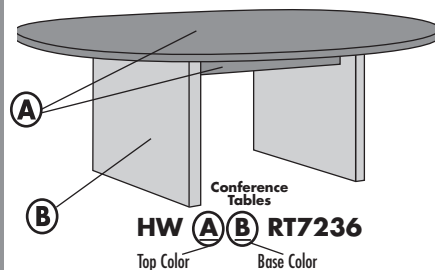
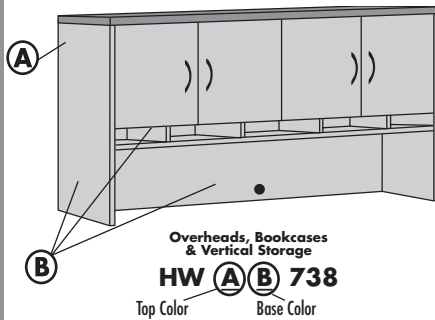
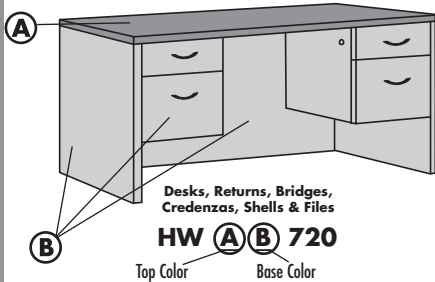

Conference tables tops NOT available in Pearwood or Black finishes.

## PEDESTALS & FILE CABINETS

All cases are ¾"-thick core with thermally fused laminate on both sides and full 3 millimeter PVC AdvantEdge banding. Choose full or ¾ height pedestals. Full modesty panels included. Units fully assembled with dowels, glue, metal brackets, screws and mechanical fasteners.

## TOPS

All tops are 1" thick with thermally fused laminate surface, proper backing and full 3 millimeter PVC AdvantEdge banding as required. All bridge and return tops feature common gain direction with connecting units. High pressure laminate tops available.

## PULL OPTIONS

Choose curvilinear pulls in brushed chrome, ebony or bright brass or oval nickel drawer/door pulls all constructed of solid metal. When ordering, use the corresponding pull designator at the beginning of the model number.

<b>HW</b>	Brushed Chrome
<b>HE</b>	Ebony
<b>HB</b>	Bright Brass
<b>HD</b>	Oval Nickel

## DRAWERS

All drawer fronts are constructed of ¾" thick core with thermally fused laminate on both sides and full 3 millimeter PVC AdvantEdge banding as required. Drawer sides are ½" thick vinyl wrap with oak grain pattern. Drawer bottoms are ⅛" thick hardboard with oak grain pattern.

- All box and center drawers suspended on smooth-action steel, ball-bearing slides ¾" extension
- File and lateral file drawers mounted on heavy-duty, ball-bearing, full-extension slides
- All file and lateral file drawers constructed for suspended filing with 25 lb. maximum weight for bottom-loading
- Drawers constructed with 5 sides for extra strength and durability. Drawer front is the fifth side and is removable for field-repair or hardware additions

## FILING

- All file drawers include pre-installed, black filing hardware with easy-adjust crossbar
- All file drawers accommodate letter-size filing front-to-back and letter- or legal-size filing side-to-side
- All lateral file drawers accommodate letter or legal-size filing side-to-side and letter or legal size filing front-to-back

## WIRE MANAGEMENT

See features for number of grommets and location. Additional grommets can be added for extended wire management capability at \$106 list per grommet. Add **G** after SKU number. Includes factory cut and installed grommet and black sleeve. Call for special quote. Specify location and quote number with order.

## PAPER FEED SLOT

Factory installed 17" x 2" paper feed slot with black protective sleeve can be added to any shell. Add PS after SKU number and add \$140 to list price. Specify location.

## LOCKS

- Desk/credenza pedestals feature single-key side locking, keyed alike
- Two drawer lateral file features single-key front locking and counter weight
- Four-drawer lateral file features central locking and anti-tilt mechanism
- Two and four-drawer lateral files keyed alike
- All locks are keyed identical unless otherwise specified
- 'Key Different' option is \$21 list upcharge per lock. Locks/cores packaged to customer requirements
- Additional lead time for 'Key Different'
- For optional locking on overhead storage units with wood doors and no inserts, add **Y** to the end of the model number and add \$150 to the list price of units with four doors or two doors not adjoining. Add \$75 for units with two adjoining doors.

## QUICKSHIP

Quick Ship is not available on any items ordered with option.

## ACCESSORIES *Factory Installed*

Certain accessories can be ordered installed prior to shipment. Add letter designator (C or K) at end of the desk or credenza model number:

<b>C</b>	Center Drawer
	-Example: HWWC720C
<b>K</b>	Keyboard Platform
	-Example: HWWC660K
<b>T</b>	Task Light
	-Example: HWWC738T

## PANELS

End panels are 1" thick core with thermally fused laminate on both sides and full 3 millimeter PVC AdvantEdge banding as required. Full modesty panels are ¾" thick core with thermally fused laminate on both sides and full 3 millimeter PVC AdvantEdge banding as required. Heavy-duty adjustable nylon leveling glides in 5" steel plate on all units.

## PACKAGING

All units are properly packed in heavy-duty cartons with reinforced corner pads. All packaging conforms to, or exceeds, specifications as outlined in the Uniform Freight Classification.

## PALLETIZATION

See page 3.

## CARE AND CLEANING INSTRUCTIONS

Normal cleaning: Clean using a soft cloth and a good window cleaner which contains no ammonia, followed by wiping dry using a dry soft cloth.

**Specifications subject to change without notice.**



## FINISH SELECTION

NATURAL MAPLE **FM** | WINDSOR CHERRY **WC** | MAHOGANY **M** |  
 GRAPHITE **GP** | MEDIUM OAK **O** | ASPEN **AP** | PEARWOOD **PW** |  
 BLACK **E** | ESPRESSO **X** | GREY **G** | CLASSIC CHERRY **CC** |

# SIN 711-2 HYPERWORK

## Configurations

Zone  
Pricing

1

2

3

### Executive U Unit

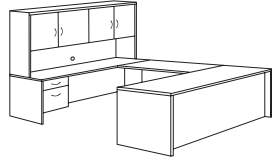

72" x 108" x 65.5"

Description	Model Number	QT	FRT.Class	Cubic FT	Ship Weight			
Right Pedestal Desk	H_721R 72" x 36" x 29"	1	200	51.6	250	<b>1217</b>	<b>1235</b>	<b>1254</b>
Bridge	HW_485 48" x 24" x 29"	1	100	4.0	66	<b>422</b>	<b>428</b>	<b>435</b>
Left Pedestal Credenza	H_725L 72" x 24" x 29"	1	125	35.7	184	<b>1054</b>	<b>1070</b>	<b>1086</b>
Overhead Storage Unit with Doors	H_737 72" x 16" x 36.5"	1	125	33.6	221	<b>1199</b>	<b>1217</b>	<b>1235</b>
Task Light	TL2P 19.5" x 3.25" x 1.25"	1	200	1.0	3	<b>124</b>	<b>126</b>	<b>128</b>
Total:				125.90	724	<b>4016</b>	<b>4076</b>	<b>4138</b>

### Executive Office with Extra Storage



144" x 108" x 65.5"

Description	Model Number	QT	FT.Class	Cubic FT	Ship Weight			
Double Pedestal Bow Front Desk	H_720B 72" x 36" x 29"	1	200	51.6	280	<b>1614</b>	<b>1638</b>	<b>1662</b>
Computer Credenza	H_744 72" x 24" x 29"	1	110	35.7	275	<b>1264</b>	<b>1283</b>	<b>1302</b>
Overhead Storage Unit with Doors	H_737 72" x 16" x 36.5"	1	125	33.6	221	<b>1199</b>	<b>1217</b>	<b>1235</b>
Five Shelf Bookcase	HW_65 36" x 16" x 65.5"	1	125	31.8	205	<b>865</b>	<b>878</b>	<b>891</b>
Storage Cabinet with Lateral File	H_65STOR 36" x 24" x 65.5"	1	125	40.3	300	<b>1668</b>	<b>1693</b>	<b>1718</b>
Total:				193.00	1281	<b>6610</b>	<b>6709</b>	<b>6808</b>

### Executive U Unit with Curved Corner Desk

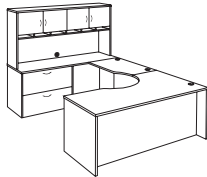

72" x 108" x 65.5"

Description	Model Number	QT	FT.Class	Cubic FT	Ship Weight			
Curved Corned Desk	H_462R 72" x 42.30" x 29"	1	200	58.9	299	<b>1692</b>	<b>1717</b>	<b>1743</b>
Asymmetrical Bridge	HW_495L 42" x 24" x 29"	1	100	4.0	56	<b>468</b>	<b>475</b>	<b>482</b>
Left Lateral File Credenza	H_733L 72" x 24" x 29"	1	125	35.7	229	<b>1342</b>	<b>1362</b>	<b>1382</b>
Overhead Storage Unit with Doors and Paper Storage Shelves	H_738 72" x 16" x 36.5"	1	125	33.6	240	<b>1529</b>	<b>1552</b>	<b>1575</b>
Total:				132.20	824	<b>5031</b>	<b>5106</b>	<b>5182</b>

### Computer Station with Corner Module

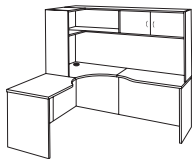

72" x 72" x 65.5"

Description	Model Number	QT	FRT.Class	Cubic FT	Ship Weight			
Corner Module	HW_448 36" x 36" x 29"	1	200	27.2	122	<b>650</b>	<b>660</b>	<b>670</b>
Left Asymmetrical Shell	HW_193624L 36" x 24" x 29"	1	200	19.8	105	<b>519</b>	<b>527</b>	<b>535</b>
Right Asymmetrical Shell	HW_193624R 36" x 24" x 29"	1	200	19.8	105	<b>519</b>	<b>527</b>	<b>535</b>
Left Corner Hutch with Doors	H_CH7236L 72" x 36" x 36.5"	1	125	45.2	253	<b>1635</b>	<b>1660</b>	<b>1684</b>
Total:				112.00	585	<b>3323</b>	<b>3374</b>	<b>3424</b>

### Cluster Work Station (4 People)



144" x 144" x 65.5"

Description	Model Number	QT	FT.Class	Cubic FT	Ship Weight			
Computer Corner Desk Left Pedestal	H_451L 72" x 36/24" x 29"	4	200	51.6	269	<b>1692</b>	<b>1717</b>	<b>1743</b>
Right Pedestal Compact Return	H_752R 36" x 24" x 29"	4	110	21.5	132	<b>825</b>	<b>837</b>	<b>850</b>
Open Overhead Storage Unit	HW_717 72" x 16" x 36.5"	4	125	33.6	181	<b>1022</b>	<b>1037</b>	<b>1053</b>
Group Total:				106.70	582	<b>14156</b>	<b>14364</b>	<b>14584</b>

UNIT	KNEESPACE	OVERHANG
72" x 36" Desk	38-1/4"	7"
72" Double Pedestal Desk	38-1/4"	13"
66" Double Pedestal Desk	32-1/4"	7"
60" Double Pedestal Desk	26-1/4"	7"

UNIT	KNEESPACE	OVERHANG
72" Double Pedestal Credenza	38-1/4"	n/a
66" Double Pedestal Credenza	32-1/4"	n/a
72" Curved Corner Desk	n/a	5"

CONTEMPORARY LAMINATE



H W FM 452R	
Pull	Finish

### MultiStation with Privacy (2 People)

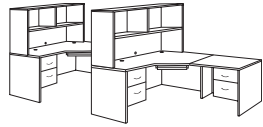

144" x 72" x 65.5"

Description	Model Number	QT	FT.Class	Cubic FT	Ship Weight	Zone Pricing		
						1	2	3
Left Pedestal Computer Corner Desk	H_451L 72" x 36/24" x 29"	2	200	51.6	269	1692	1717	1743
Right Pedestal Compact Return	H_452R 36" x 24" x 29"	2	110	21.5	132	825	837	850
Open Overhead Storage Unit	HW_717 72" x 16" x 36.5"	2	125	33.6	181	1022	1037	1053
Group Total:					582	7078	7182	7292

### Double Workstation (2 People)



180" x 72" x 65.5"

Description	Model Number	QT	FT.Class	Cubic FT	Ship Weight	Zone Pricing		
						1	2	3
Left Pedestal Credenza	H_725L 72" x 24" x 29"	1	125	35.7	184	1054	1070	1086
Right Pedestal Credenza	H_725R 72" x 24" x 29"	1	125	35.7	184	1054	1070	1086
Peninsula Desk	HW_799 72" x 36" x 29"	1	125	51.6	155	861	874	887
Bridge	HW_485 48" x 24" x 29"	2	100	4.0	66	422	428	435
Overhead Storage Unit with Doors	H_737 72" x 16" x 36.5"	2	125	33.6	221	1199	1217	1235
Open Overhead Storage Unit	HW_317 36" x 16" x 36.5"	1	125	15.3	105	499	506	514
Group Total:					915	6710	6810	6913

### Reception Station

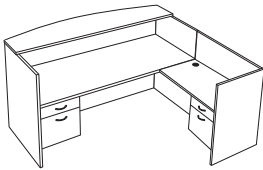

144" x 72" x 65.5"

Description	Model Number	QT	FT.Class	Cubic FT	Ship Weight	Zone Pricing		
						1	2	3
Left Pedestal Reception Desk	H_7230L 72" x 36" x 42"	1	200	64.9	343	1559	1582	1606
Right Pedestal Reception Return	H_2442R 42" x 24" x 41"	1	110	32.9	195	1040	1056	1071
Total:					538	2599	2638	2677

## Desks

### Double Pedestal Bow Front Desk

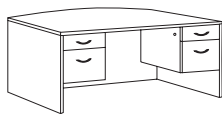

- Bow front top
- Box/File pedestals
- Pre-installed black filing hardware
- Letter or legal filing
- Individually locking pedestals

Freight Class: 200

<b>H_720B</b>	<b>QS</b>	72" X 36" X 29"	Cubic Ft: 51.6	Ship Weight: 280	<b>1614</b>	<b>1638</b>	<b>1662</b>	
					<b>Center Drawer C</b>	177	180	182
					<b>Keyboard Platform K</b>	203	206	209

<b>Pulls:</b>	BRUSHED CHROME <b>HW</b>	EBONY <b>HE</b>	BRIGHT BRASS <b>HB</b>	OVAL NICKEL <b>HD</b>
---------------	--------------------------	-----------------	------------------------	-----------------------

<b>QS FINISHES</b>	<b>WC</b>	<b>QS PULLS</b>	<b>W</b>
--------------------	-----------	-----------------	----------

### Double Full Pedestal Bow Front Desk



- Bow front top
- File/File left pedestal
- Box/Box/File right pedestal
- Pre-installed black filing hardware
- Letter or legal filing
- Individually locking pedestals

Freight Class: 110

<b>H_720BF2B</b>		72" X 36" X 29"	Cubic Ft: 51.6	Ship Weight: 330	<b>2050</b>	<b>2081</b>	<b>2112</b>	
					<b>Center Drawer C</b>	177	180	182
					<b>Keyboard Platform K</b>	203	206	209

<b>Pulls:</b>	BRUSHED CHROME <b>HW</b>	EBONY <b>HE</b>	BRIGHT BRASS <b>HB</b>	OVAL NICKEL <b>HD</b>
---------------	--------------------------	-----------------	------------------------	-----------------------

### Double Full Pedestal Bow Front Desk with Aluminum/Frosted Modesty Panel



- Bow front top
- Aluminum frosted modesty panel
- Box/Box/File right pedestal
- File/File left pedestal
- Pre-installed black filing hardware
- Letter or legal filing
- Locking pedestal

Freight Class: 110

<b>H_701BF2B</b>		72" X 36" X 29"	Cubic Ft: 51.6	Ship Weight: 325	<b>2583</b>	<b>2622</b>	<b>2660</b>	
					<b>Center Drawer C</b>	177	180	182
					<b>Keyboard Platform K</b>	203	206	209

<b>Pulls:</b>	BRUSHED CHROME <b>HW</b>	EBONY <b>HE</b>	BRIGHT BRASS <b>HB</b>	OVAL NICKEL <b>HD</b>
---------------	--------------------------	-----------------	------------------------	-----------------------

## FINISH SELECTION

NATURAL MAPLE **FM** | WINDSOR CHERRY **WC** | MAHOGANY **M** |  
 GRAPHITE **GP** | MEDIUM OAK **O** | ASPEN **AP** | PEARWOOD **PW** |  
 BLACK **E** | ESPRESSO **X** | GREY **G** | CLASSIC CHERRY **CC** |

# SIN 711-2 HYPERWORK

### Double Pedestal Desk

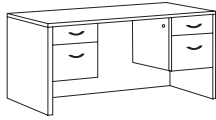

- Box/File pedestals
- Pre-installed black filing hardware
- Letter or legal filing
- Individually locking pedestals

Freight Class: 110

### Double Full Pedestal Desk

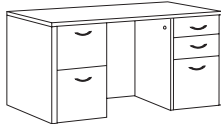

- File/File left pedestal
- Box/Box/File right pedestal
- Pre-installed black filing hardware
- Letter or legal filing
- Individually locking pedestals

Freight Class: 110

### Double Full Pedestal Desk With Aluminum/Frosted Modesty Panel

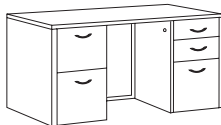

- File/File left pedestal
- Box/Box/File right pedestal
- Pre-installed black filing hardware
- Letter or legal filing
- Individually locking pedestals
- Aluminum/frosted modesty panel

Freight Class: 110

### Left Pedestal Bow Front Desk

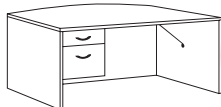

- Bow front top
- Box/File left pedestal
- Pre-installed black filing hardware
- Letter or legal filing
- Side locking

Freight Class: 200

### Right Pedestal Bow Front Desk

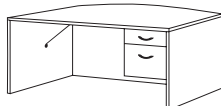

- Bow front top
- Box/File right pedestal
- Pre-installed black filing hardware
- Letter or legal filing
- Side locking

Freight Class: 200

### Left Full Pedestal Bow Front Desk

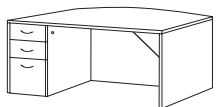

- Bow front top
- Box/Box/File left pedestal
- Pre-installed black filing hardware
- Letter or legal filing
- Side locking

Freight Class: 200

		Zone Pricing	1	2	3
<b>H__720</b>	<b>QS</b> 72" X 36" X 29" Cubic Ft: 51.6 Ship Weight: 289		<b>1391</b>	<b>1412</b>	<b>1433</b>
	<b>Center Drawer C</b>		177	180	182
	<b>Keyboard Platform K</b>		203	206	209
<b>H__700</b>	72" X 30" X 29" Cubic Ft: 44.4 Ship Weight: 259		<b>1243</b>	<b>1262</b>	<b>1280</b>
	<b>Center Drawer C</b>		177	180	182
	<b>Keyboard Platform K</b>		203	206	209
<b>H__660</b>	66" X 30" X 29" Cubic Ft: 40.2 Ship Weight: 249		<b>1217</b>	<b>1235</b>	<b>1254</b>
	<b>Center Drawer C</b>		177	180	182
	<b>Keyboard Platform K</b>		203	206	209
<b>H__600</b>	60" X 30" X 29" Cubic Ft: 36.7 Ship Weight: 235		<b>1175</b>	<b>1193</b>	<b>1210</b>
	<b>Center Drawer C</b>		177	180	182
	<b>Keyboard Platform K</b>		203	206	209
<b>Pulls:</b>	BRUSHED CHROME <b>HW</b>   EBONY <b>HE</b>   BRIGHT BRASS <b>HB</b>   OVAL NICKEL <b>HD</b>				
	<b>QS FINISHES WC</b>   <b>QS PULLS W</b>				

<b>H__720F2BF</b>	72" X 36" X 29" Cubic Ft: 51.6 Ship Weight: 330		<b>1786</b>	<b>1813</b>	<b>1840</b>
	<b>Center Drawer C</b>		177	180	182
	<b>Keyboard Platform K</b>		203	206	209
<b>H__700F2BF</b>	72" X 30" X 29" Cubic Ft: 44.4 Ship Weight: 299		<b>1745</b>	<b>1771</b>	<b>1797</b>
	<b>Center Drawer C</b>		177	180	182
	<b>Keyboard Platform K</b>		203	206	209
<b>H__660F2BF</b>	66" X 30" X 29" Cubic Ft: 40.2 Ship Weight: 289		<b>1678</b>	<b>1703</b>	<b>1728</b>
	<b>Center Drawer C</b>		177	180	182
	<b>Keyboard Platform K</b>		203	206	209
<b>H__600F2BF</b>	60" X 30" X 29" Cubic Ft: 36.7 Ship Weight: 280		<b>1626</b>	<b>1650</b>	<b>1675</b>
	<b>Center Drawer C</b>		165	167	170
	<b>Keyboard Platform K</b>		196	199	202
<b>Pulls:</b>	BRUSHED CHROME <b>HW</b>   EBONY <b>HE</b>   BRIGHT BRASS <b>HB</b>   OVAL NICKEL <b>HD</b>				

<b>H__701F2BF</b>	72" X 36" X 29" Cubic Ft: 51.6 Ship Weight: 330		<b>2313</b>	<b>2348</b>	<b>2382</b>
	<b>Center Drawer C</b>		177	180	182
	<b>Keyboard Platform K</b>		203	206	209
<b>Pulls:</b>	BRUSHED CHROME <b>HW</b>   EBONY <b>HE</b>   BRIGHT BRASS <b>HB</b>   OVAL NICKEL <b>HD</b>				

<b>H__721LB</b>	72" X 36" X 29" Cubic Ft: 51.6 Ship Weight: 250		<b>1416</b>	<b>1437</b>	<b>1458</b>
	<b>Center Drawer C</b>		165	167	170
	<b>Keyboard Platform K</b>		196	199	202
<b>Pulls:</b>	BRUSHED CHROME <b>HW</b>   EBONY <b>HE</b>   BRIGHT BRASS <b>HB</b>   OVAL NICKEL <b>HD</b>				

<b>H__721RB</b>	72" X 36" X 29" Cubic Ft: 51.6 Ship Weight: 250		<b>1416</b>	<b>1437</b>	<b>1458</b>
	<b>Center Drawer C</b>		165	167	170
	<b>Keyboard Platform K</b>		196	199	202
<b>Pulls:</b>	BRUSHED CHROME <b>HW</b>   EBONY <b>HE</b>   BRIGHT BRASS <b>HB</b>   OVAL NICKEL <b>HD</b>				

<b>H__721LB2BF</b>	72" X 36" X 29" Cubic Ft: 51.6 Ship Weight: 262		<b>1620</b>	<b>1644</b>	<b>1669</b>
	<b>Center Drawer C</b>		165	167	170
	<b>Keyboard Platform K</b>		196	199	202
<b>Pulls:</b>	BRUSHED CHROME <b>HW</b>   EBONY <b>HE</b>   BRIGHT BRASS <b>HB</b>   OVAL NICKEL <b>HD</b>				

CONTEMPORARY LAMINATE



Zone Pricing

1

2

3

### Right Full Pedestal Bow Front Desk

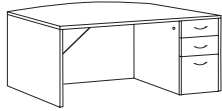

- Bow front top
- Box/Box/File right pedestal
- Pre-installed black filing hardware
- Letter or legal filing
- Side locking

Freight Class: 200

<b>H_721RB2BF</b>	72" X 36" X 29"	Cubic Ft: 51.6	Ship Weight: 262	<b>1620</b>	<b>1644</b>	<b>1669</b>
				<b>Center Drawer C</b>	165	167
				<b>Keyboard Platform K</b>	196	199
<b>Pulls:</b>	BRUSHED CHROME <b>HW</b>	EBONY <b>HE</b>	BRIGHT BRASS <b>HB</b>	OVAL NICKEL <b>HD</b>		

### Left Full Pedestal Bow Front Desk With Aluminum/Frosted Modesty Panel

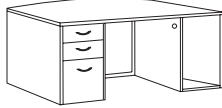

- Aluminum/frosted modesty panel
- Box/Box/File left pedestal
- Open storage right pedestal
- Pre-installed black filing hardware
- Letter or legal filing
- Locking pedestal

Freight Class: 110

<b>H_701LB2BF</b>	72" X 36" X 29"	Cubic Ft: 51.6	Ship Weight: 282	<b>2228</b>	<b>2261</b>	<b>2295</b>
				<b>Center Drawer C</b>	165	167
				<b>Keyboard Platform K</b>	196	199
<b>Pulls:</b>	BRUSHED CHROME <b>HW</b>	EBONY <b>HE</b>	BRIGHT BRASS <b>HB</b>	OVAL NICKEL <b>HD</b>		

### Right Full Pedestal Bow Front Desk With Aluminum/Frosted Modesty Panel

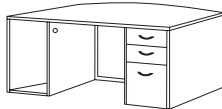

- Aluminum/frosted modesty panel
- Box/Box/File right pedestal
- Open storage left pedestal
- Pre-installed black filing hardware
- Letter or legal filing
- Locking pedestal

Freight Class: 110

<b>H_701RB2BF</b>	72" X 36" X 29"	Cubic Ft: 51.6	Ship Weight: 282	<b>2228</b>	<b>2261</b>	<b>2295</b>
				<b>Center Drawer C</b>	165	167
				<b>Keyboard Platform K</b>	196	199
<b>Pulls:</b>	BRUSHED CHROME <b>HW</b>	EBONY <b>HE</b>	BRIGHT BRASS <b>HB</b>	OVAL NICKEL <b>HD</b>		

### Left Pedestal Desk

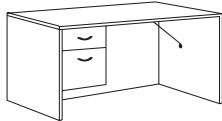

- Box/File left pedestal
- Pre-installed black filing hardware
- Letter or legal filing
- Side locking

<b>H_721L QS</b>	72" X 36" X 29"	Cubic Ft: 51.6	Ship Weight: 250	<b>1217</b>	<b>1235</b>	<b>1254</b>
Freight Class: 200				<b>Center Drawer C</b>	165	167
				<b>Keyboard Platform K</b>	196	199
<b>H_700L</b>	72" X 30" X 29"	Cubic Ft: 44.4	Ship Weight: 225	<b>1118</b>	<b>1135</b>	<b>1152</b>
Freight Class: 200				<b>Center Drawer C</b>	165	167
				<b>Keyboard Platform K</b>	196	199
<b>H_651L QS</b>	66" X 30" X 29"	Cubic Ft: 40.6	Ship Weight: 218	<b>1106</b>	<b>1123</b>	<b>1139</b>
Freight Class: 200				<b>Center Drawer C</b>	165	167
				<b>Keyboard Platform K</b>	196	199
<b>H_641L</b>	60" X 30" X 29"	Cubic Ft: 36.7	Ship Weight: 199	<b>970</b>	<b>985</b>	<b>999</b>
Freight Class: 200				<b>Center Drawer C</b>	165	167
				<b>Keyboard Platform K</b>	196	199
<b>H_431L</b>	48" X 30" X 29"	Cubic Ft: 30.1	Ship Weight: 179	<b>887</b>	<b>900</b>	<b>914</b>
Freight Class: 110				<b>Center Drawer C</b>	165	167
				<b>Keyboard Platform K</b>	196	199
<b>Pulls:</b>	BRUSHED CHROME <b>HW</b>	EBONY <b>HE</b>	BRIGHT BRASS <b>HB</b>	OVAL NICKEL <b>HD</b>		

**QS FINISHES WC**

**QS PULLS W**

### Right Pedestal Desk

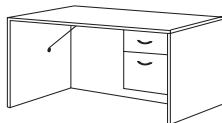

- Box/File right pedestal
- Pre-installed black filing hardware
- Letter or legal filing
- Side locking

<b>H_721R QS</b>	72" X 36" X 29"	Cubic Ft: 51.6	Ship Weight: 250	<b>1217</b>	<b>1235</b>	<b>1254</b>
Freight Class: 200				<b>Center Drawer C</b>	165	167
				<b>Keyboard Platform K</b>	196	199
<b>H_700R</b>	72" X 30" X 29"	Cubic Ft: 44.4	Ship Weight: 225	<b>1118</b>	<b>1135</b>	<b>1152</b>
Freight Class: 200				<b>Center Drawer C</b>	165	167
				<b>Keyboard Platform K</b>	196	199
<b>H_651R QS</b>	66" X 30" X 29"	Cubic Ft: 40.6	Ship Weight: 218	<b>1106</b>	<b>1123</b>	<b>1139</b>
Freight Class: 200				<b>Center Drawer C</b>	165	167
				<b>Keyboard Platform K</b>	196	199
<b>H_641R</b>	60" X 30" X 29"	Cubic Ft: 36.7	Ship Weight: 199	<b>970</b>	<b>985</b>	<b>999</b>
Freight Class: 200						
<b>H_431R</b>	48" X 30" X 29"	Cubic Ft: 30.1	Ship Weight: 179	<b>887</b>	<b>900</b>	<b>914</b>
Freight Class: 110				<b>Center Drawer C</b>	165	167
				<b>Keyboard Platform K</b>	196	199
<b>Pulls:</b>	BRUSHED CHROME <b>HW</b>	EBONY <b>HE</b>	BRIGHT BRASS <b>HB</b>	OVAL NICKEL <b>HD</b>		

**QS FINISHES WC**

**QS PULLS W**

# FINISH SELECTION

NATURAL MAPLE **FM** | WINDSOR CHERRY **WC** | MAHOGANY **M** |  
 GRAPHITE **GP** | MEDIUM OAK **O** | ASPEN **AP** | PEARWOOD **PW** |  
 BLACK **E** | ESPRESSO **X** | GREY **G** | CLASSIC CHERRY **CC** |

# SIN 711-2 HYPERWORK

## Left Full Pedestal Desk

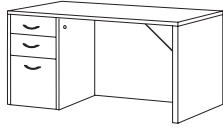

- Box/Box/File left pedestal
- Pre-installed black filing hardware
- Letter or legal filing
- Side locking pedestal

		Zone Pricing	1	2	3
<b>H_721L2BF</b>	72" X 36" X 29" Cubic Ft: 51.6 Ship Weight: 275		<b>1358</b>	<b>1378</b>	<b>1399</b>
Freight Class: 200		<b>Center Drawer C</b>	165	167	170
		<b>Keyboard Platform K</b>	196	199	202
<b>H_700L2BF</b>	72" X 30" X 29" Cubic Ft: 44.4 Ship Weight: 250		<b>1316</b>	<b>1336</b>	<b>1355</b>
Freight Class: 110		<b>Center Drawer C</b>	165	167	170
		<b>Keyboard Platform K</b>	196	199	202
<b>H_651L2BF</b>	66" X 30" X 29" Cubic Ft: 40.6 Ship Weight: 243		<b>1270</b>	<b>1289</b>	<b>1308</b>
Freight Class: 110		<b>Center Drawer C</b>	165	167	170
		<b>Keyboard Platform K</b>	196	199	202
<b>H_641L2BF</b>	60" X 30" X 29" Cubic Ft: 36.7 Ship Weight: 224		<b>1084</b>	<b>1100</b>	<b>1117</b>
Freight Class: 110		<b>Center Drawer C</b>	165	167	170
		<b>Keyboard Platform K</b>	196	199	202
<b>H_431L2BF</b>	48" X 30" X 29" Cubic Ft: 30.1 Ship Weight: 192		<b>990</b>	<b>1005</b>	<b>1020</b>
Freight Class: 110		<b>Center Drawer C</b>	165	167	170
		<b>Keyboard Platform K</b>	196	199	202

<b>Pulls:</b>	BRUSHED CHROME <b>HW</b>	EBONY <b>HE</b>	BRIGHT BRASS <b>HB</b>	OVAL NICKEL <b>HD</b>
---------------	--------------------------	-----------------	------------------------	-----------------------

## Right Full Pedestal Desk

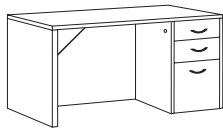

- Same description as above except:
- Box/Box/File right pedestal

<b>H_721R2BF</b>	72" X 36" X 29" Cubic Ft: 51.6 Ship Weight: 275		<b>1358</b>	<b>1378</b>	<b>1399</b>
Freight Class: 200		<b>Center Drawer C</b>	165	167	170
		<b>Keyboard Platform K</b>	196	199	202
<b>H_700R2BF</b>	72" X 30" X 29" Cubic Ft: 44.4 Ship Weight: 250		<b>1316</b>	<b>1336</b>	<b>1355</b>
Freight Class: 110		<b>Center Drawer C</b>	165	167	170
		<b>Keyboard Platform K</b>	196	199	202
<b>H_651R2BF</b>	66" X 30" X 29" Cubic Ft: 40.2 Ship Weight: 243		<b>1270</b>	<b>1289</b>	<b>1308</b>
Freight Class: 110		<b>Center Drawer C</b>	165	167	170
		<b>Keyboard Platform K</b>	196	199	202
<b>H_641R2BF</b>	60" X 30" X 29" Cubic Ft: 36.7 Ship Weight: 224		<b>1084</b>	<b>1100</b>	<b>1117</b>
Freight Class: 110		<b>Center Drawer C</b>	165	167	170
		<b>Keyboard Platform K</b>	196	199	202
<b>H_431R2BF</b>	48" X 30" X 29" Cubic Ft: 30.1 Ship Weight: 192		<b>990</b>	<b>1005</b>	<b>1020</b>
Freight Class: 110		<b>Center Drawer C</b>	165	167	170
		<b>Keyboard Platform K</b>	196	199	202

<b>Pulls:</b>	BRUSHED CHROME <b>HW</b>	EBONY <b>HE</b>	BRIGHT BRASS <b>HB</b>	OVAL NICKEL <b>HD</b>
---------------	--------------------------	-----------------	------------------------	-----------------------

## Left Full Pedestal Desk With Aluminum/Frosted Modesty Panel

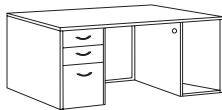

- Aluminum/frosted modesty panel
- Box/Box/File left pedestal
- Open storage right pedestal
- Pre-installed black filing hardware
- Letter or legal filing
- Locking pedestal

Freight Class: 110

<b>H_701L2BF</b>	72" X 36" X 29" Cubic Ft: 51.6 Ship Weight: 295		<b>2118</b>	<b>2150</b>	<b>2182</b>
		<b>Center Drawer C</b>	165	167	170
		<b>Keyboard Platform K</b>	196	199	202

<b>Pulls:</b>	BRUSHED CHROME <b>HW</b>	EBONY <b>HE</b>	BRIGHT BRASS <b>HB</b>	OVAL NICKEL <b>HD</b>
---------------	--------------------------	-----------------	------------------------	-----------------------

## Right Full Pedestal Desk With Aluminum/Frosted Modesty Panel

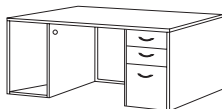

- Same description as above except:
- Box/Box/File right pedestal
- Open storage left pedestal

Freight Class: 110

<b>H_701R2BF</b>	72" X 36" X 29" Cubic Ft: 51.6 Ship Weight: 295		<b>2118</b>	<b>2150</b>	<b>2182</b>
		<b>Center Drawer C</b>	165	167	170
		<b>Keyboard Platform K</b>	196	199	202

<b>Pulls:</b>	BRUSHED CHROME <b>HW</b>	EBONY <b>HE</b>	BRIGHT BRASS <b>HB</b>	OVAL NICKEL <b>HD</b>
---------------	--------------------------	-----------------	------------------------	-----------------------

CONTEMPORARY LAMINATE



H	W	FM	451R
Pull		Finish	

## Corner Desks

Zone Pricing

1

2

3

### Left Pedestal Computer Corner Desk

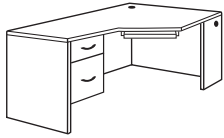

- Easy computer pullup
- Keyboard platform standard
- Locking Box/File left pedestal
- Pre-installed, black filing hardware
- Legal or letter filing
- One grommet in top, one in modesty panel and one in half leg

Freight Class: 200

**H\_451L** 72" X 36/24" X 29" Cubic Ft: 51.6 Ship Weight: 269 **1692** **1717** **1743**

**Pulls:** BRUSHED CHROME **HW** EBONY **HE** BRIGHT BRASS **HB** OVAL NICKEL **HD**

### Right Pedestal Computer Corner Desk



- Same description as above except:
- Locking Box/File right pedestal

Freight Class: 200

**H\_451R** 72" X 36/24" X 29" Cubic Ft: 51.6 Ship Weight: 269 **1692** **1717** **1743**

**Pulls:** BRUSHED CHROME **HW** EBONY **HE** BRIGHT BRASS **HB** OVAL NICKEL **HD**

### Left Full Pedestal Computer Corner Desk



- Easy computer pullup
- Keyboard platform standard
- Locking Box/Box/File left pedestal
- Pre-installed, black filing hardware
- Legal or letter filing
- One grommet in top, one in modesty panel and one in half leg

Freight Class: 110

**H\_451L2BF** 72" X 36/24" X 29" Cubic Ft: 51.6 Ship Weight: 294 **1857** **1885** **1913**

**Pulls:** BRUSHED CHROME **HW** EBONY **HE** BRIGHT BRASS **HB** OVAL NICKEL **HD**

### Right Full Pedestal Computer Corner Desk

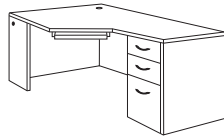

- Same description as above except:
- Locking Box/Box/File right pedestal

Freight Class: 110

**H\_451R2BF** 72" X 36/24" X 29" Cubic Ft: 51.6 Ship Weight: 294 **1857** **1885** **1913**

**Pulls:** BRUSHED CHROME **HW** EBONY **HE** BRIGHT BRASS **HB** OVAL NICKEL **HD**

### Left Pedestal Curved Corner Desk

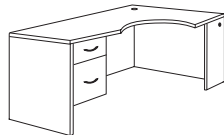

- Use with right asymmetrical bridge or shell
- Full-access worksurface
- Locking Box/File left pedestal
- Pre-installed, black filing hardware
- Legal or letter filing
- One grommet in top and one in half leg

Freight Class: 200

**H\_462L** 72" X 42/30" X 29" Cubic Ft: 58.9 Ship Weight: 299 **1692** **1717** **1743**

**Pulls:** BRUSHED CHROME **HW** EBONY **HE** BRIGHT BRASS **HB** OVAL NICKEL **HD**

### Right Pedestal Curved Corner Desk

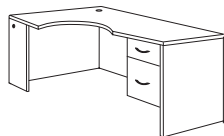

- Same description as above except:
- Locking Box/File right pedestal

Freight Class: 200

**H\_462R** 72" X 42/30" X 29" Cubic Ft: 58.9 Ship Weight: 299 **1692** **1717** **1743**

**Pulls:** BRUSHED CHROME **HW** EBONY **HE** BRIGHT BRASS **HB** OVAL NICKEL **HD**

### Left Full Pedestal Curved Corner Desk

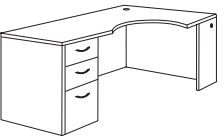

- Use with right asymmetrical bridge or shell with 19" connection
- Full-access worksurface
- Locking Box/Box/File left pedestal
- Pre-installed, black filing hardware
- Legal or letter filing
- One grommet in top and one in half leg

Freight Class: 110

**H\_462L2BF** 72" X 42/30" X 29" Cubic Ft: 58.9 Ship Weight: 324 **1857** **1885** **1913**

**Pulls:** BRUSHED CHROME **HW** EBONY **HE** BRIGHT BRASS **HB** OVAL NICKEL **HD**

### Right Full Pedestal Curved Corner Desk



- Same description as above except:
- Locking Box/Box/File right pedestal

Freight Class: 110

**H\_462R2BF** 72" X 42/30" X 29" Cubic Ft: 58.9 Ship Weight: 324 **1857** **1885** **1913**

**Pulls:** BRUSHED CHROME **HW** EBONY **HE** BRIGHT BRASS **HB** OVAL NICKEL **HD**

CONTEMPORARY LAMINATE



FINISH SELECTION

NATURAL MAPLE **FM** | WINDSOR CHERRY **WC** | MAHOGANY **M** | GRAPHITE **GP** | MEDIUM OAK **O** | ASPEN **AP** | PEARWOOD **PW** | BLACK **E** | ESPRESSO **X** | GREY **G** | CLASSIC CHERRY **CC** |

SIN 711-2 **HYPERWORK**

**Peninsulas & P-Top Desks**

Zone Pricing	1	2	3
--------------	---	---	---

**Peninsula Desk**

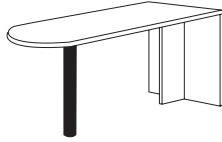

- Use with returns, bridges or rectangular shells
- Steel 4" diameter black cylinder base with leveling glide
- End support panel

Freight Class: 125

<b>HW_799</b>	<b>QS</b>	72" X 36" X 29"	Cubic Ft: 51.6	Ship Weight: 155	<b>861</b>	<b>874</b>	<b>887</b>
---------------	-----------	-----------------	----------------	------------------	------------	------------	------------

**QS FINISHES WC**

**Peninsula Desk with Modesty Panel**

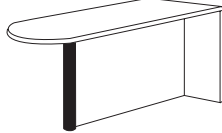

- Use with returns, bridges or rectangular shells
- Steel 4" diameter black cylinder base with leveling glide
- Full modesty panel
- End support panel

Freight Class: 125

<b>HW_798</b>		72" X 36" X 29"	Cubic Ft: 51.6	Ship Weight: 185	<b>894</b>	<b>907</b>	<b>921</b>
---------------	--	-----------------	----------------	------------------	------------	------------	------------

**Peninsula Top and Column**

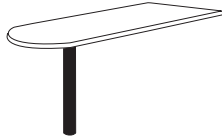

- Connect unsupported end to rectangular shell or credenza
- Steel 4" diameter black cylinder base with leveling glide
- Assembly required

Freight Class: 85

<b>HW_797</b>		72" X 36" X 29"	Cubic Ft: 51.6	Ship Weight: 115	<b>705</b>	<b>716</b>	<b>726</b>
---------------	--	-----------------	----------------	------------------	------------	------------	------------

**Left P-Shape Desk**

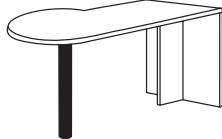

- Use with bridges, right returns or rectangular shells
- Allows mini-conferencing within office
- Steel 4" diameter black cylinder base with leveling glide
- End support panel

Freight Class: 125

<b>HW_899L</b>		72" X 42/30" X 29"	Cubic Ft: 58.9	Ship Weight: 160	<b>987</b>	<b>1002</b>	<b>1017</b>
----------------	--	--------------------	----------------	------------------	------------	-------------	-------------

**Right P-Shape Desk**

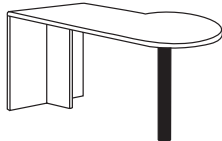

- Same descriptions as above except:
- Use with bridges, left returns or rectangular shells

Freight Class: 125

<b>HW_899R</b>		72" X 42/30" X 29"	Cubic Ft: 58.9	Ship Weight: 160	<b>987</b>	<b>1002</b>	<b>1017</b>
----------------	--	--------------------	----------------	------------------	------------	-------------	-------------

**Left P-Shape Desk with Modesty Panel**

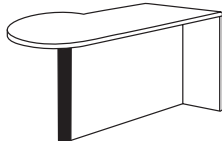

- Use with bridges, right returns or rectangular shells
- Allows mini-conferencing within office
- Steel 4" diameter black cylinder base with leveling glide
- Full modesty panel
- End support panel

Freight Class: 250

<b>HW_898L</b>		72" X 42/30" X 29"	Cubic Ft: 58.9	Ship Weight: 190	<b>1046</b>	<b>1062</b>	<b>1077</b>
----------------	--	--------------------	----------------	------------------	-------------	-------------	-------------

**Right P-Shape Desk with Modesty Panel**

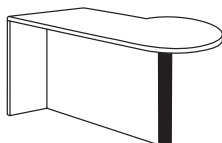

- Same description as above except:
- Use with bridges, left returns or rectangular shells

Freight Class: 250

<b>HW_898R</b>		72" X 42/30" X 29"	Cubic Ft: 58.9	Ship Weight: 190	<b>1046</b>	<b>1062</b>	<b>1077</b>
----------------	--	--------------------	----------------	------------------	-------------	-------------	-------------

CONTEMPORARY LAMINATE



H W FM 735L	
Pull	Finish

Zone Pricing	1	2	3
--------------	---	---	---

### Left P-Shape Top and Column



- Connect unsupported end to rectangular shell or right credenza
- Allows mini-conferencing within office
- Steel 4" diameter black cylinder base with leveling glide
- Assembly required

Freight Class: 125

<b>HW_897L</b>	72" X 42/30" X 29" Cubic Ft: 18.2 Ship Weight: 125	<b>863</b>	<b>876</b>	<b>889</b>
----------------	--	------------	------------	------------

### Right P-Shape Top and Column

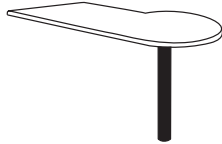

- Same description as above except:
- Connect unsupported end to rectangular shell or left credenza

Freight Class: 125

<b>HW_897R</b>	72" X 42/30" X 29" Cubic Ft: 18.2 Ship Weight: 125	<b>863</b>	<b>876</b>	<b>889</b>
----------------	--	------------	------------	------------

## Credenzas

### MultiFile Credenza

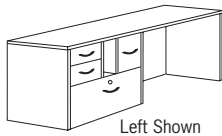

Left Shown

- One lateral file drawer with lock
- One file drawer
- Pre-installed, black filing hardware
- Legal or letter filing
- Two box drawers
- HOT PROJECTS ACCESS SLOT
- H\_735L - Left pedestal
- H\_735R - Right pedestal

Freight Class: 125

<b>H_735L</b>	72" X 24" X 29" Cubic Ft: 35.7 Ship Weight: 261	<b>1422</b>	<b>1443</b>	<b>1465</b>
---------------	---	-------------	-------------	-------------

<b>H_735R</b>	72" X 24" X 29" Cubic Ft: 35.7 Ship Weight: 261	<b>1422</b>	<b>1443</b>	<b>1465</b>
---------------	---	-------------	-------------	-------------

<b>Pulls:</b>	BRUSHED CHROME <b>HW</b>	EBONY <b>HE</b>	BRIGHT BRASS <b>HB</b>	OVAL NICKEL <b>HD</b>
---------------	--------------------------	-----------------	------------------------	-----------------------

**EXTRA THICK BOTTOM** \$80 **H**

### Computer Credenza

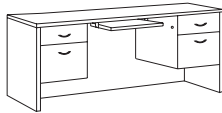

- Box/File pedestals
- Pre-installed, black filing hardware
- Legal or letter filing
- Keyboard platform standard
- Grommet in modesty panel
- Individually locking pedestals

Freight Class: 110

<b>H_744</b>	<b>QS</b> 72" X 24" X 29" Cubic Ft: 35.7 Ship Weight: 275	<b>1264</b>	<b>1283</b>	<b>1302</b>
--------------	---	-------------	-------------	-------------

<b>H_644</b>	66" X 24" X 29" Cubic Ft: 32.8 Ship Weight: 250	<b>1221</b>	<b>1239</b>	<b>1258</b>
--------------	---	-------------	-------------	-------------

<b>Pulls:</b>	BRUSHED CHROME <b>HW</b>	EBONY <b>HE</b>	BRIGHT BRASS <b>HB</b>	OVAL NICKEL <b>HD</b>
---------------	--------------------------	-----------------	------------------------	-----------------------

**QS FINISHES WC**      **QS PULLS W**

### Full Pedestal Computer Credenza

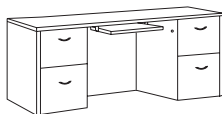

- Same description as above except:
- File/File pedestals

Freight Class: 110

<b>H_744F</b>	72" X 24" X 29" Cubic Ft: 35.7 Ship Weight: 305	<b>1521</b>	<b>1544</b>	<b>1567</b>
---------------	---	-------------	-------------	-------------

<b>H_644F</b>	66" X 24" X 29" Cubic Ft: 32.8 Ship Weight: 280	<b>1475</b>	<b>1497</b>	<b>1519</b>
---------------	---	-------------	-------------	-------------

<b>Pulls:</b>	BRUSHED CHROME <b>HW</b>	EBONY <b>HE</b>	BRIGHT BRASS <b>HB</b>	OVAL NICKEL <b>HD</b>
---------------	--------------------------	-----------------	------------------------	-----------------------

### Double Lateral File Credenza



- Four full-size lateral file drawers
- Pre-installed, black filing hardware
- Legal or letter filing
- Front locking

Freight Class: 125

<b>H_733</b>	72.5" X 24" X 29" Cubic Ft: 35.7 Ship Weight: 299	<b>1817</b>	<b>1844</b>	<b>1872</b>
--------------	---	-------------	-------------	-------------

<b>Pulls:</b>	BRUSHED CHROME <b>HW</b>	EBONY <b>HE</b>	BRIGHT BRASS <b>HB</b>	OVAL NICKEL <b>HD</b>
---------------	--------------------------	-----------------	------------------------	-----------------------

**EXTRA THICK BOTTOM** \$320 **H**

### Left Lateral File/Bookcase Credenza



- Two full-size lateral file drawers left
- Front locking lateral file
- Pre-installed, black filing hardware
- Legal or letter filing
- Bookcase with doors and adjustable shelf right

Freight Class: 125

<b>H_BK733L</b>	72.5" X 24" X 29" Cubic Ft: 35.7 Ship Weight: 299	<b>1635</b>	<b>1660</b>	<b>1684</b>
-----------------	---	-------------	-------------	-------------

<b>Pulls:</b>	BRUSHED CHROME <b>HW</b>	EBONY <b>HE</b>	BRIGHT BRASS <b>HB</b>	OVAL NICKEL <b>HD</b>
---------------	--------------------------	-----------------	------------------------	-----------------------

**EXTRA THICK BOTTOM** \$160 **H**

# FINISH SELECTION

NATURAL MAPLE **FM** | WINDSOR CHERRY **WC** | MAHOGANY **M** | GRAPHITE **GP** | MEDIUM OAK **O** | ASPEN **AP** | PEARWOOD **PW** | BLACK **E** | ESPRESSO **X** | GREY **G** | CLASSIC CHERRY **CC** |

# SIN 711-2 HYPERWORK

## Right Lateral File/Bookcase Credenza



- Same description as above except:
- Lateral file on right
- Bookcase on left

Freight Class: 125

		Zone Pricing		1	2	3
<b>H_BK733R</b>	72.5" X 24" X 29" Cubic Ft: 35.7 Ship Weight: 306	<b>1635</b>	<b>1660</b>	<b>1684</b>		
<b>Pulls:</b>	BRUSHED CHROME <b>HW</b>   EBONY <b>HE</b>   BRIGHT BRASS <b>HB</b>   OVAL NICKEL <b>HD</b>					
	<b>EXTRA THICK BOTTOM</b>				\$160	<b>H</b>

## Left Pedestal Credenza



- Box/File left pedestal
- Pre-installed, black filing hardware
- Legal or letter filing
- Side locking
- One wire management grommet in modesty panel
- Use 19" deep bridge with H\_615L credenza to allow more kneespace

Freight Class: 125

<b>H_725L QS</b>	72" X 24" X 29" Cubic Ft: 35.7 Ship Weight: 184	<b>1054</b>	<b>1070</b>	<b>1086</b>		
	<b>Center Drawer C</b>	165	167	170		
	<b>Keyboard Platform K</b>	196	199	202		
<b>H_625L</b>	66" X 24" X 29" Cubic Ft: 32 Ship Weight: 174	<b>1035</b>	<b>1051</b>	<b>1066</b>		
	<b>Center Drawer C</b>	165	167	170		
	<b>Keyboard Platform K</b>	196	199	202		
<b>H_615L</b>	60" X 24" X 29" Cubic Ft: 30.5 Ship Weight: 164	<b>1001</b>	<b>1016</b>	<b>1031</b>		
	<b>Center Drawer C</b>	165	167	170		
	<b>Keyboard Platform K</b>	196	199	202		
<b>Pulls:</b>	BRUSHED CHROME <b>HW</b>   EBONY <b>HE</b>   BRIGHT BRASS <b>HB</b>   OVAL NICKEL <b>HD</b>					
	<b>QS FINISHES WC</b>   <b>QS PULLS W</b>					

## Right Pedestal Credenza



- Same description as above except:
- Box/File right pedestal

Freight Class: 125

<b>H_725R QS</b>	72" X 24" X 29" Cubic Ft: 35.7 Ship Weight: 184	<b>1054</b>	<b>1070</b>	<b>1086</b>		
	<b>Center Drawer C</b>	165	167	170		
	<b>Keyboard Platform K</b>	196	199	202		
<b>H_625R</b>	66" X 24" X 29" Cubic Ft: 32 Ship Weight: 174	<b>1035</b>	<b>1051</b>	<b>1066</b>		
	<b>Center Drawer C</b>	165	167	170		
	<b>Keyboard Platform K</b>	196	199	202		
<b>H_615R</b>	60" X 24" X 29" Cubic Ft: 30.5 Ship Weight: 164	<b>1001</b>	<b>1016</b>	<b>1031</b>		
	<b>Center Drawer C</b>	165	167	170		
	<b>Keyboard Platform K</b>	196	199	202		
<b>Pulls:</b>	BRUSHED CHROME <b>HW</b>   EBONY <b>HE</b>   BRIGHT BRASS <b>HB</b>   OVAL NICKEL <b>HD</b>					
	<b>QS FINISHES WC</b>   <b>QS PULLS W</b>					

## Left Full Pedestal Credenza



- Box/File left pedestal
- Pre-installed, black filing hardware
- Legal or letter filing
- Side locking
- One wire management grommet in modesty panel
- Use 19" deep bridge with H\_615LF credenza to allow more kneespace

Freight Class: 125

<b>H_725LF</b>	72" X 24" X 29" Cubic Ft: 35.7 Ship Weight: 199	<b>1263</b>	<b>1282</b>	<b>1301</b>		
	<b>Center Drawer C</b>	165	167	170		
	<b>Keyboard Platform K</b>	196	199	202		
<b>H_625LF</b>	66" X 24" X 29" Cubic Ft: 32 Ship Weight: 189	<b>1248</b>	<b>1267</b>	<b>1285</b>		
	<b>Center Drawer C</b>	165	167	170		
	<b>Keyboard Platform K</b>	196	199	202		
<b>H_615LF</b>	60" X 24" X 29" Cubic Ft: 30.5 Ship Weight: 179	<b>1231</b>	<b>1249</b>	<b>1268</b>		
	<b>Center Drawer C</b>	165	167	170		
	<b>Keyboard Platform K</b>	196	199	202		
<b>Pulls:</b>	BRUSHED CHROME <b>HW</b>   EBONY <b>HE</b>   BRIGHT BRASS <b>HB</b>   OVAL NICKEL <b>HD</b>					

## Right Full Pedestal Credenza

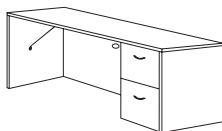

- Same description as above except:
- File/File right pedestal

Freight Class: 125

<b>H_725RF</b>	72" X 24" X 29" Cubic Ft: 35.7 Ship Weight: 199	<b>1263</b>	<b>1282</b>	<b>1301</b>		
	<b>Center Drawer C</b>	165	167	170		
	<b>Keyboard Platform K</b>	196	199	202		
<b>H_625RF</b>	66" X 24" X 29" Cubic Ft: 32 Ship Weight: 189	<b>1248</b>	<b>1267</b>	<b>1285</b>		
	<b>Center Drawer C</b>	165	167	170		
	<b>Keyboard Platform K</b>	196	199	202		
<b>H_615RF</b>	60" X 24" X 29" Cubic Ft: 30.5 Ship Weight: 179	<b>1231</b>	<b>1249</b>	<b>1268</b>		
	<b>Center Drawer C</b>	165	167	170		
	<b>Keyboard Platform K</b>	196	199	202		
<b>Pulls:</b>	BRUSHED CHROME <b>HW</b>   EBONY <b>HE</b>   BRIGHT BRASS <b>HB</b>   OVAL NICKEL <b>HD</b>					

CONTEMPORARY LAMINATE



H W FM 733L	
Pull	Finish

Zone Pricing	1	2	3
--------------	---	---	---

### Left Lateral File Credenza



- Two lateral file drawers on left
- Pre-installed, black filing hardware
- Legal or letter filing
- Front locking

Freight Class: 125

<b>H_733L</b>	72" X 24" X 29"	Cubic Ft: 35.7	Ship Weight: 229	<b>1342</b>	<b>1362</b>	<b>1382</b>
<b>H_633L</b>	66" X 24" X 29"	Cubic Ft: 32	Ship Weight: 219	<b>1295</b>	<b>1314</b>	<b>1334</b>

<b>Pulls:</b>	BRUSHED CHROME <b>HW</b>	EBONY <b>HE</b>	BRIGHT BRASS <b>HB</b>	OVAL NICKEL <b>HD</b>
---------------	--------------------------	-----------------	------------------------	-----------------------

**EXTRA THICK BOTTOM** \$160 **H**

### Right Lateral File Credenza

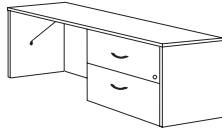

- Same description as above except:
- Two lateral file drawers on right

Freight Class: 125

<b>H_733R</b>	72" X 24" X 29"	Cubic Ft: 35.7	Ship Weight: 229	<b>1342</b>	<b>1362</b>	<b>1382</b>
<b>H_633R</b>	66" X 24" X 29"	Cubic Ft: 32	Ship Weight: 219	<b>1295</b>	<b>1314</b>	<b>1334</b>

<b>Pulls:</b>	BRUSHED CHROME <b>HW</b>	EBONY <b>HE</b>	BRIGHT BRASS <b>HB</b>	OVAL NICKEL <b>HD</b>
---------------	--------------------------	-----------------	------------------------	-----------------------

**EXTRA THICK BOTTOM** \$160 **H**

### Left Bookcase Credenza

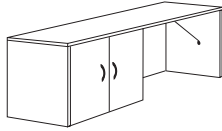

- Bookcase compartment with one adjustable shelf on left
- Doors conceal contents from view
- Inside dimensions 34" x 21" x 24"

Freight Class: 125

<b>H_734L</b>	72" X 24" X 29"	Cubic Ft: 35.7	Ship Weight: 225	<b>1342</b>	<b>1362</b>	<b>1382</b>
<b>H_634L</b>	66" X 24" X 29"	Cubic Ft: 32	Ship Weight: 219	<b>1295</b>	<b>1314</b>	<b>1334</b>

<b>Pulls:</b>	BRUSHED CHROME <b>HW</b>	EBONY <b>HE</b>	BRIGHT BRASS <b>HB</b>	OVAL NICKEL <b>HD</b>
---------------	--------------------------	-----------------	------------------------	-----------------------

### Right Bookcase Credenza

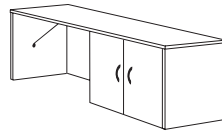

- Same description as above except:
- Bookcase compartment on right

Freight Class: 125

<b>H_734R</b>	72" X 24" X 29"	Cubic Ft: 35.7	Ship Weight: 225	<b>1342</b>	<b>1362</b>	<b>1382</b>
<b>H_634R</b>	66" X 24" X 29"	Cubic Ft: 32	Ship Weight: 219	<b>1295</b>	<b>1314</b>	<b>1334</b>

<b>Pulls:</b>	BRUSHED CHROME <b>HW</b>	EBONY <b>HE</b>	BRIGHT BRASS <b>HB</b>	OVAL NICKEL <b>HD</b>
---------------	--------------------------	-----------------	------------------------	-----------------------

### Double Bookcase Credenza

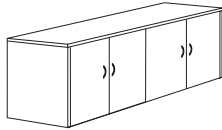

- Two bookcase compartments, each with adjustable shelf
- Doors conceal contents from view
- Bookcase compartment dimensions: 34" x 21" x 25"

Freight Class: 125

<b>H_734</b>	72.5" X 24" X 29"	Cubic Ft: 35.7	Ship Weight: 313	<b>1476</b>	<b>1498</b>	<b>1520</b>
--------------	-------------------	----------------	------------------	-------------	-------------	-------------

<b>Pulls:</b>	BRUSHED CHROME <b>HW</b>	EBONY <b>HE</b>	BRIGHT BRASS <b>HB</b>	OVAL NICKEL <b>HD</b>
---------------	--------------------------	-----------------	------------------------	-----------------------

## Returns & Bridges

### Left MultiFile Return



- MultiFile on left with one locking lateral file drawer
- One file and two box drawers
- Pre-installed, black filing hardware
- Legal or letter filing
- HOT PROJECTS ACCESS SLOT
- Connects with single pedestal desks or credenzas

Freight Class: 110

<b>H_735LRT</b>	72" X 24" X 29"	Cubic Ft: 35.7	Ship Weight: 250	<b>1422</b>	<b>1443</b>	<b>1465</b>
-----------------	-----------------	----------------	------------------	-------------	-------------	-------------

<b>Keyboard Platform K</b>	196	199	202
----------------------------	-----	-----	-----

<b>Pulls:</b>	BRUSHED CHROME <b>HW</b>	EBONY <b>HE</b>	BRIGHT BRASS <b>HB</b>	OVAL NICKEL <b>HD</b>
---------------	--------------------------	-----------------	------------------------	-----------------------

**EXTRA THICK BOTTOM** \$80 **H**

## FINISH SELECTION

NATURAL MAPLE **FM** | WINDSOR CHERRY **WC** | MAHOGANY **M** | GRAPHITE **GP** | MEDIUM OAK **O** | ASPEN **AP** | PEARWOOD **PW** | BLACK **E** | ESPRESSO **X** | GREY **G** | CLASSIC CHERRY **CC** |

# SIN 711-2 HYPERWORK

### Right MultiFile Return

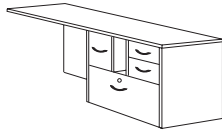

- Same description as above except:
- MultiFile on right

Freight Class: 110

### Left Lateral File Return



- Two lateral file drawers
- Pre-installed filing hardware
- Legal or letter filing
- Connects with single pedestal desk or credenza

Freight Class: 110

### Right Lateral File Return

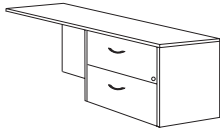

- Two lateral file drawers
- Pre-installed filing hardware
- Legal or letter filing
- Connects with single pedestal desk or credenza

Freight Class: 110

### Left Pedestal Desk Height Return

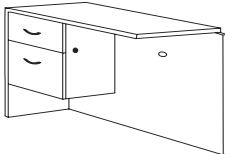

- Box/File left pedestal
- Pre-installed, black filing hardware
- Legal or letter filing
- Wire management grommet in modesty panel
- Side locking

Freight Class: 110

### Right Pedestal Desk Height Return

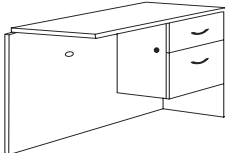

- Same description as above except:
- Box/File right pedetals

Freight Class: 110

### Left Full Pedestal Desk Height Return

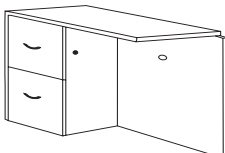

- File/File left pedestal
- Pre-installed, black filing hardware
- Legal or letter filing
- Wire management grommet in modesty panel
- Side locking

Freight Class: 110

Zone Pricing

1

2

3

<b>H_735RRT</b>	72" X 24" X 29"	Cubic Ft: 35.7	Ship Weight: 250	<b>1422</b>	<b>1443</b>	<b>1465</b>
				<b>Keyboard Platform K</b>	196	202
<b>Pulls:</b> BRUSHED CHROME <b>HW</b>   EBONY <b>HE</b>   BRIGHT BRASS <b>HB</b>   OVAL NICKEL <b>HD</b>						
<b>EXTRA THICK BOTTOM</b>						\$80 <b>H</b>

<b>H_733LRT</b>	72" X 24" X 29"	Cubic Ft: 35.7	Ship Weight: 220	<b>1277</b>	<b>1296</b>	<b>1315</b>
				<b>Keyboard Platform K</b>	196	202
<b>Pulls:</b> BRUSHED CHROME <b>HW</b>   EBONY <b>HE</b>   BRIGHT BRASS <b>HB</b>   OVAL NICKEL <b>HD</b>						
<b>EXTRA THICK BOTTOM</b>						\$160 <b>H</b>

<b>H_733RRT</b>	72" X 24" X 29"	Cubic Ft: 35.7	Ship Weight: 220	<b>1277</b>	<b>1296</b>	<b>1315</b>
				<b>Keyboard Platform K</b>	196	202
<b>Pulls:</b> BRUSHED CHROME <b>HW</b>   EBONY <b>HE</b>   BRIGHT BRASS <b>HB</b>   OVAL NICKEL <b>HD</b>						
<b>EXTRA THICK BOTTOM</b>						\$160 <b>H</b>

<b>H_722L QS</b>	48" X 24" X 29"	Cubic Ft: 24.3	Ship Weight: 149	<b>849</b>	<b>862</b>	<b>874</b>
				<b>Keyboard Platform K</b>	196	202
<b>H_622L</b>	42" X 24" X 29"	Cubic Ft: 21.5	Ship Weight: 140	<b>828</b>	<b>840</b>	<b>853</b>
				<b>Keyboard Platform K</b>	196	202
<b>H_452L QS</b>	36" X 24" X 29"	Cubic Ft: 21.5	Ship Weight: 132	<b>825</b>	<b>837</b>	<b>850</b>
<b>Pulls:</b> BRUSHED CHROME <b>HW</b>   EBONY <b>HE</b>   BRIGHT BRASS <b>HB</b>   OVAL NICKEL <b>HD</b>						

**QS FINISHES WC**

**QS PULLS W**

<b>H_722R QS</b>	48" X 24" X 29"	Cubic Ft: 24.3	Ship Weight: 149	<b>849</b>	<b>862</b>	<b>874</b>
				<b>Keyboard Platform K</b>	196	202
<b>H_622R</b>	42" X 24" X 29"	Cubic Ft: 21.5	Ship Weight: 140	<b>828</b>	<b>840</b>	<b>853</b>
				<b>Keyboard Platform K</b>	196	202
<b>H_452R QS</b>	36" X 24" X 29"	Cubic Ft: 21.5	Ship Weight: 132	<b>825</b>	<b>837</b>	<b>850</b>
<b>Pulls:</b> BRUSHED CHROME <b>HW</b>   EBONY <b>HE</b>   BRIGHT BRASS <b>HB</b>   OVAL NICKEL <b>HD</b>						

**QS FINISHES WC**

**QS PULLS W**

<b>H_762LF</b>	60" X 24" X 29"	Cubic Ft: 24.3	Ship Weight: 163	<b>1123</b>	<b>1140</b>	<b>1157</b>
				<b>Keyboard Platform K</b>	196	202
<b>H_722LF</b>	48" X 24" X 29"	Cubic Ft: 24.3	Ship Weight: 163	<b>1040</b>	<b>1056</b>	<b>1071</b>
				<b>Keyboard Platform K</b>	196	202
<b>H_622LF</b>	42" X 24" X 29"	Cubic Ft: 21.5	Ship Weight: 156	<b>1026</b>	<b>1041</b>	<b>1057</b>
				<b>Keyboard Platform K</b>	196	202
<b>H_452LF</b>	36" X 24" X 29"	Cubic Ft: 21.5	Ship Weight: 148	<b>1006</b>	<b>1021</b>	<b>1036</b>
<b>Pulls:</b> BRUSHED CHROME <b>HW</b>   EBONY <b>HE</b>   BRIGHT BRASS <b>HB</b>   OVAL NICKEL <b>HD</b>						

CONTEMPORARY LAMINATE



H W FM 762RF	
Pull	Finish

### Right Full Pedestal Desk Height Return

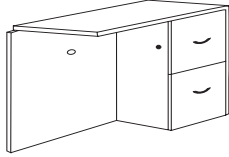

- Same description as above except:
- File/File right pedestal

Freight Class: 110

				Zone Pricing	1	2	3
<b>H_762RF</b>	60" X 24" X 29"	Cubic Ft: 24.3	Ship Weight: 163		<b>1123</b>	<b>1140</b>	<b>1157</b>
				<b>Keyboard Platform K</b>	196	199	202
<b>H_722RF</b>	48" X 24" X 29"	Cubic Ft: 24.3	Ship Weight: 163		<b>1040</b>	<b>1056</b>	<b>1071</b>
				<b>Keyboard Platform K</b>	196	199	202
<b>H_622RF</b>	42" X 24" X 29"	Cubic Ft: 21.5	Ship Weight: 156		<b>1026</b>	<b>1041</b>	<b>1057</b>
				<b>Keyboard Platform K</b>	196	199	202
<b>H_452RF</b>	36" X 24" X 29"	Cubic Ft: 21.5	Ship Weight: 148		<b>1006</b>	<b>1021</b>	<b>1036</b>

<b>Pulls:</b>	BRUSHED CHROME <b>HW</b>	EBONY <b>HE</b>	BRIGHT BRASS <b>HB</b>	OVAL NICKEL <b>HD</b>
---------------	--------------------------	-----------------	------------------------	-----------------------

### Desk Height Bridge



- Two wire management grommets in modesty panel
- Requires assembly of top to modesty panel
- Use HW\_384 with 60" desks to allow more kneespace

Freight Class: 100

<b>HW_485</b>	<b>QS</b>	48" X 24" X 29"	Cubic Ft: 4	Ship Weight: 66	<b>422</b>	<b>428</b>	<b>435</b>
<b>HW_484</b>		42" X 24" X 29"	Cubic Ft: 4	Ship Weight: 58	<b>414</b>	<b>420</b>	<b>426</b>
<b>HW_384</b>		42" X 19" X 29"	Cubic Ft: 4	Ship Weight: 48	<b>418</b>	<b>424</b>	<b>431</b>

**QS FINISHES WC**

### Left Asymmetrical Bridge



- Connects at both ends; not freestanding
- Radius 19" deep right end connects with curved corner desk or 36" corner module
- Two grommets in modesty panel
- Requires assembly

Freight Class: 100

<b>HW_496L</b>		48" X 24" X 29"	Cubic Ft: 4	Ship Weight: 66	<b>483</b>	<b>490</b>	<b>497</b>
<b>HW_495L</b>		42" X 24" X 29"	Cubic Ft: 4	Ship Weight: 56	<b>468</b>	<b>475</b>	<b>482</b>

### Right Asymmetrical Bridge

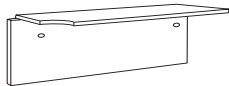

- Connects at both ends; not freestanding
- Radius 19" deep left end connects with curved corner desk or 36" corner module
- Two grommets in modesty panel
- Requires assembly

Freight Class: 100

<b>HW_496R</b>		48" X 24" X 29"	Cubic Ft: 4	Ship Weight: 66	<b>483</b>	<b>490</b>	<b>497</b>
<b>HW_495R</b>		42" X 24" X 29"	Cubic Ft: 4	Ship Weight: 56	<b>468</b>	<b>475</b>	<b>482</b>

## Corner Units

### Corner Module

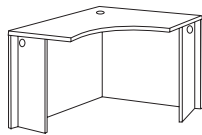

- Curved surface for easy pullup and full access to work area
- Freestanding with two half-legs
- Use 42" x 42" module with 30" deep asymmetrical shells (24" hookup) or 24" deep rectangular shells
- Use 36" x 36" module with 24" deep asymmetrical shells (19" hookup)
- One grommet in top, two in modesty and one in each support leg

Freight Class: 200

<b>HW_449</b>	42" X 42" X 29"	Cubic Ft: 34.3	Ship Weight: 152	<b>737</b>	<b>748</b>	<b>759</b>
<b>HW_448</b>	36" X 36" X 29"	Cubic Ft: 27.2	Ship Weight: 122	<b>650</b>	<b>660</b>	<b>670</b>

### Corner Module with Open Modesty Panel

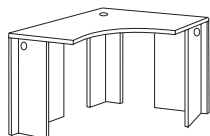

- Curved surface for easy pullup and full access to work area
- Freestanding with two half-legs
- Use 42" x 42" module with 30" deep asymmetrical shells (24" hookup) or 24" deep rectangular shells
- Use 36" x 36" module with 24" deep asymmetrical shells (19" hookup)
- One grommet in top and one in each half leg

Freight Class: 200

<b>HW_4490</b>	42" X 42" X 29"	Cubic Ft: 34.3	Ship Weight: 137	<b>693</b>	<b>703</b>	<b>714</b>
<b>HW_4480</b>	36" X 36" X 29"	Cubic Ft: 27.2	Ship Weight: 107	<b>610</b>	<b>619</b>	<b>628</b>



## FINISH SELECTION

NATURAL MAPLE **FM** | WINDSOR CHERRY **WC** | MAHOGANY **M** |  
 GRAPHITE **GP** | MEDIUM OAK **O** | ASPEN **AP** | PEARWOOD **PW** |  
 BLACK **E** | ESPRESSO **X** | GREY **G** | CLASSIC CHERRY **CC** |

# SIN 711-2 HYPERWORK

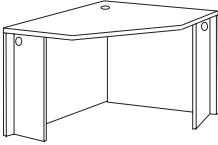
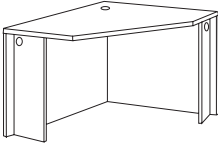
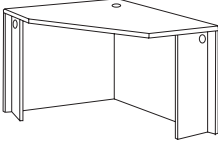
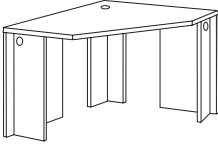
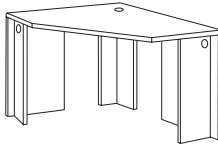
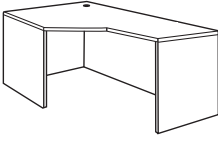
				Zone Pricing	1	2	3	
<b>Corner Module with Straight Front</b>				<b>HW_449S</b>	42" X 42" X 29" Cubic Ft: 34.3 Ship Weight: 153	<b>737</b>	<b>748</b>	<b>759</b>
	<ul style="list-style-type: none"> <li>• Freestanding with two half legs</li> <li>• Straight surface across front</li> <li>• Easy computer pull up</li> <li>• One grommet in top, two in modesty panel and one in each half leg</li> <li>• 24" hookups</li> </ul>	Freight Class: 200						
<b>Left Dual Depth Corner Module</b>				<b>HW_44930L</b>	42" X 42" X 29" Cubic Ft: 34.3 Ship Weight: 162	<b>674</b>	<b>684</b>	<b>694</b>
	<ul style="list-style-type: none"> <li>• Attach 30" deep shell/return on left</li> <li>• Attach 24" deep shell/return on right</li> <li>• Two half legs</li> <li>• One grommet in top, two in modesty and one in each support leg</li> </ul>	Freight Class: 200						
<b>Right Dual Depth Corner Module</b>				<b>HW_44930R</b>	42" X 42" X 29" Cubic Ft: 34.3 Ship Weight: 162	<b>674</b>	<b>684</b>	<b>694</b>
	<ul style="list-style-type: none"> <li>• Attach 30" deep shell/return on right</li> <li>• Attach 24" deep shell/return on left</li> <li>• Two half legs</li> <li>• One grommet in top, two in modesty and one in each support leg</li> </ul>	Freight Class: 200						
<b>Left Dual Depth Corner Module, Open Modesty Panel</b>				<b>HW_44930LO</b>	42" X 42" X 29" Cubic Ft: 38 Ship Weight: 152	<b>647</b>	<b>657</b>	<b>666</b>
	<ul style="list-style-type: none"> <li>• Attach 30" deep shell/return on left</li> <li>• Attach 24" deep shell/return on right</li> <li>• Freestanding with open modesty for easy access to electrical outlets</li> <li>• One grommet in top, two in corner support and one in each half leg</li> </ul>	Freight Class: 200						
<b>Right Dual Depth Corner Module, Open Modesty Panel</b>				<b>HW_44930RO</b>	42" X 42" X 29" Cubic Ft: 37.96 Ship Weight: 152	<b>647</b>	<b>657</b>	<b>666</b>
	<ul style="list-style-type: none"> <li>• Attach 30" deep shell/return on right</li> <li>• Attach 24" deep shell/return on left</li> <li>• Freestanding with open modesty for easy access to electrical outlets</li> <li>• One grommet in top, two in corner support and one in each half leg</li> </ul>	Freight Class: 200						
<b>Extended Corners &amp; Returns</b>								
<b>Left Extended Corner</b>				<b>HW_475L</b>	72" X 36/24" X 29" Cubic Ft: 51.6 Ship Weight: 219	<b>946</b>	<b>960</b>	<b>974</b>
	<ul style="list-style-type: none"> <li>• Corner on left</li> <li>• Two full legs</li> <li>• Easy computer pullup</li> <li>• One grommet in top, one in modesty panel</li> <li>• Freestanding</li> </ul>	Freight Class: 200						
					<b>Keyboard Platform K</b>	196	199	202
				<b>HW_465L</b>	66" X 36/24" X 29" Cubic Ft: 48.2 Ship Weight: 209	<b>899</b>	<b>912</b>	<b>926</b>
					<b>Keyboard Platform K</b>	196	199	202

CONTEMPORARY LAMINATE



### Right Extended Corner

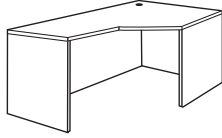

- Same description as above except:
- Corner on right

Freight Class: 200

### Left Extended Corner

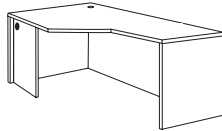

- Corner on left
- Easy computer pullup
- Full right, half left leg
- One grommet in top, one in modesty and one in half leg
- Corner may connect with return or bridge/credenza
- Optional keyboard platform, utility pedestal
- Freestanding

Freight Class: 200

### Right Extended Corner

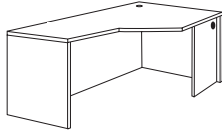

- Same description as above except:
- Corner on right
- Full left, half right leg

Freight Class: 200

### Left Extended Corner Return

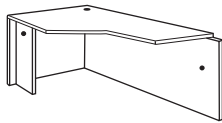

- Must connect to desk at 24" deep end
- Corner on left; connectable
- Easy computer pullup
- One grommet in top and two in modesty panel and one in half leg
- Not freestanding

Freight Class: 200

### Right Extended Corner Return

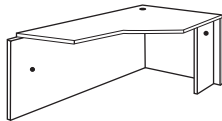

- Same description as above except:
- Corner on right; connectable

Freight Class: 200

### Left Extended Corner

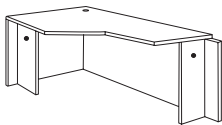

- Must connect to desk at 24" deep end
- Corner on left; connectable
- Easy computer pullup
- Two half legs
- One grommet in top and two in modesty panel and one in each half leg
- Not freestanding

Freight Class: 200

### Right Extended Corner

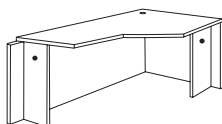

- Same description as above except:
- Corner on right; connectable

Freight Class: 200

Zone Pricing

1

2

3

<b>HW_475R</b>	72" X 36/24" X 29"	Cubic Ft: 51.6	Ship Weight: 219	<b>946</b>	<b>960</b>	<b>974</b>
				<b>Keyboard Platform K</b>	196	202
<b>HW_465R</b>	66" X 36/24" X 29"	Cubic Ft: 48.2	Ship Weight: 209	<b>899</b>	<b>912</b>	<b>926</b>
				<b>Keyboard Platform K</b>	196	202

<b>HW_476L</b>	72" X 36/24" X 29"	Cubic Ft: 51.6	Ship Weight: 209	<b>946</b>	<b>960</b>	<b>974</b>
				<b>Keyboard Platform K</b>	196	202
<b>HW_466L</b>	66" X 36/24" X 29"	Cubic Ft: 48.2	Ship Weight: 199	<b>899</b>	<b>912</b>	<b>926</b>
				<b>Keyboard Platform K</b>	196	202

<b>HW_476R</b>	72" X 36/24" X 29"	Cubic Ft: 51.6	Ship Weight: 209	<b>946</b>	<b>960</b>	<b>974</b>
				<b>Keyboard Platform K</b>	196	202
<b>HW_466R</b>	66" X 36/24" X 29"	Cubic Ft: 48.2	Ship Weight: 199	<b>899</b>	<b>912</b>	<b>926</b>
				<b>Keyboard Platform K</b>	196	202

<b>HW_450L</b>	<b>QS</b>	72" X 36/24" X 29"	Cubic Ft: 51.6	Ship Weight: 198	<b>941</b>	<b>955</b>	<b>969</b>
					<b>Keyboard Platform K</b>	196	202

**QS FINISHES WC**

<b>HW_450R</b>	<b>QS</b>	72" X 36/24" X 29"	Cubic Ft: 51.6	Ship Weight: 198	<b>941</b>	<b>955</b>	<b>969</b>
					<b>Keyboard Platform K</b>	196	202

**QS FINISHES WC**

<b>HW_450LH</b>	72" X 36/24" X 29"	Cubic Ft: 51.6	Ship Weight: 209	<b>946</b>	<b>960</b>	<b>974</b>
				<b>Keyboard Platform K</b>	196	202
<b>HW_440LH</b>	66" X 36/24" X 29"	Cubic Ft: 48.2	Ship Weight: 189	<b>899</b>	<b>912</b>	<b>926</b>
				<b>Keyboard Platform K</b>	196	202

<b>HW_450RH</b>	72" X 36/24" X 29"	Cubic Ft: 51.6	Ship Weight: 209	<b>946</b>	<b>960</b>	<b>974</b>
				<b>Keyboard Platform K</b>	196	202
<b>HW_440RH</b>	66" X 36/24" X 29"	Cubic Ft: 48.2	Ship Weight: 189	<b>899</b>	<b>912</b>	<b>926</b>
				<b>Keyboard Platform K</b>	196	202

## FINISH SELECTION

NATURAL MAPLE **FM** | WINDSOR CHERRY **WC** | MAHOGANY **M** |  
 GRAPHITE **GP** | MEDIUM OAK **O** | ASPEN **AP** | PEARWOOD **PW** |  
 BLACK **E** | ESPRESSO **X** | GREY **G** | CLASSIC CHERRY **CC** |

# SIN 711-2 HYPERWORK

### Left Extended Corner

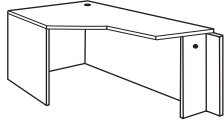

- Must connect to desk at 24" deep end
- Easy computer pullup
- Full left, half right leg
- One grommet in top and two in modesty panel and one in half leg
- Not freestanding

Freight Class: 200

### Right Extended Corner

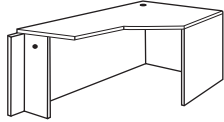

- Same description as above except:
- Full right, half left leg

Freight Class: 200

## Asymmetrical Shells, 30" Deep

### Left Asymmetrical Shell

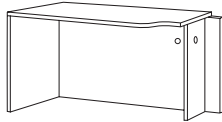

- Radius 24" deep (right) end connects with 42" corner module
- 30" deep on left
- Full left, half right leg
- Grommet in modesty panel and half leg

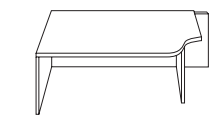

Support legs on 72", 66" and 60" lengths should be relocated inward (12" from either end) for increased worksurface support

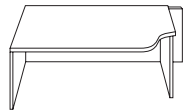

Support leg on 48", 42", 36" and 30" lengths located close to ends

Freight Class: 200

### Right Asymmetrical Shell

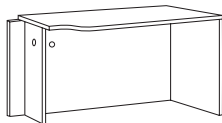

- Radius 24" deep (left) end connects with 42" corner
- 30" Deep right
- Full right, half left leg
- Grommet in modesty panel and half leg

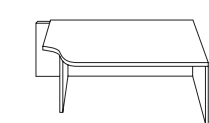

Support legs on 72", 66" and 60" lengths should be relocated inward (12" from either end) for increased worksurface support

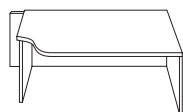

Support leg on 48", 42", 36" and 30" lengths located close to ends

Freight Class: 200

		Zone Pricing	1	2	3
<b>HW_450LF</b>	72" X 36/24" X 29" Cubic Ft: 51.6 Ship Weight: 219		<b>946</b>	<b>960</b>	<b>974</b>
	<b>Keyboard Platform K</b>		196	199	202
<b>HW_440LF</b>	66" X 36/24" X 29" Cubic Ft: 48.2 Ship Weight: 199		<b>899</b>	<b>912</b>	<b>926</b>
	<b>Keyboard Platform K</b>		196	199	202
<b>HW_450RF</b>	72" X 36/24" X 29" Cubic Ft: 51.6 Ship Weight: 219		<b>946</b>	<b>960</b>	<b>974</b>
	<b>Keyboard Platform K</b>		196	199	202
<b>HW_440RF</b>	66" X 36/24" X 29" Cubic Ft: 48.2 Ship Weight: 199		<b>899</b>	<b>912</b>	<b>926</b>
	<b>Keyboard Platform K</b>		196	199	202

<b>HW_247230L</b>	72" X 30" X 29" Cubic Ft: 44.4 Ship Weight: 175	<b>705</b>	<b>716</b>	<b>726</b>
<b>HW_246630L</b>	66" X 30" X 29" Cubic Ft: 40.2 Ship Weight: 165	<b>684</b>	<b>694</b>	<b>705</b>
<b>HW_246030L</b>	60" X 30" X 29" Cubic Ft: 36.7 Ship Weight: 155	<b>658</b>	<b>668</b>	<b>678</b>

<b>HW_244830L</b>	48" X 30" X 29" Cubic Ft: 30.1 Ship Weight: 135	<b>610</b>	<b>619</b>	<b>628</b>
<b>HW_244230L</b>	42" X 30" X 29" Cubic Ft: 30.1 Ship Weight: 125	<b>579</b>	<b>588</b>	<b>596</b>
<b>HW_243630L</b>	36" X 30" X 29" Cubic Ft: 23 Ship Weight: 115	<b>551</b>	<b>559</b>	<b>568</b>
<b>HW_243030L</b>	30" X 30" X 29" Cubic Ft: 23 Ship Weight: 105	<b>521</b>	<b>529</b>	<b>537</b>

<b>HW_247230R</b>	72" X 30" X 29" Cubic Ft: 44.4 Ship Weight: 175	<b>705</b>	<b>716</b>	<b>726</b>
<b>HW_246630R</b>	66" X 30" X 29" Cubic Ft: 40.2 Ship Weight: 165	<b>684</b>	<b>694</b>	<b>705</b>
<b>HW_246030R</b>	60" X 30" X 29" Cubic Ft: 36.7 Ship Weight: 155	<b>658</b>	<b>668</b>	<b>678</b>

<b>HW_244830R</b>	48" X 30" X 29" Cubic Ft: 30.1 Ship Weight: 135	<b>610</b>	<b>619</b>	<b>628</b>
<b>HW_244230R</b>	42" X 30" X 29" Cubic Ft: 30.1 Ship Weight: 125	<b>579</b>	<b>588</b>	<b>596</b>
<b>HW_243630R</b>	36" X 30" X 29" Cubic Ft: 23 Ship Weight: 115	<b>551</b>	<b>559</b>	<b>568</b>
<b>HW_243030R</b>	30" X 30" X 29" Cubic Ft: 23 Ship Weight: 105	<b>521</b>	<b>529</b>	<b>537</b>

CONTEMPORARY LAMINATE



Zone Pricing	1	2	3
--------------	---	---	---

### Left Asymmetrical Bridge/Shell

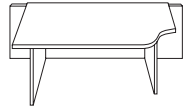
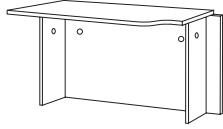

- Connects at both ends; not freestanding
- Radius 24" deep (right) end connects with 42" corner module
- 30" deep left
- Two half legs
- Two grommets in modesty and one in each half leg
- Assembly required

Support legs on 72", 66" and 60" lengths should be relocated inward (12" from either end) for increased worksurface support



Support leg on 48", 42", 36" and 30" lengths located close to ends

Freight Class: 125

<b>HW_247230LH</b>	72" X 30" X 29"	Cubic Ft: 7.16	Ship Weight: 150	<b>705</b>	<b>716</b>	<b>726</b>
<b>HW_246630LH</b>	66" X 30" X 29"	Cubic Ft: 6.2	Ship Weight: 137	<b>684</b>	<b>694</b>	<b>705</b>
<b>HW_246030LH</b>	60" X 30" X 29"	Cubic Ft: 6	Ship Weight: 125	<b>658</b>	<b>668</b>	<b>678</b>

<b>HW_244830LH</b>	48" X 30" X 29"	Cubic Ft: 4.9	Ship Weight: 100	<b>610</b>	<b>619</b>	<b>628</b>
<b>HW_244230LH</b>	42" X 30" X 29"	Cubic Ft: 4.9	Ship Weight: 87	<b>579</b>	<b>588</b>	<b>596</b>
<b>HW_243630LH</b>	36" X 30" X 29"	Cubic Ft: 4.01	Ship Weight: 75	<b>551</b>	<b>559</b>	<b>568</b>
<b>HW_243030LH</b>	30" X 30" X 29"	Cubic Ft: 4.01	Ship Weight: 62	<b>521</b>	<b>529</b>	<b>537</b>

### Right Asymmetrical Bridge/Shell

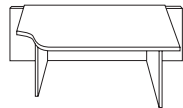
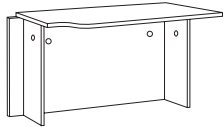

- Connects at both ends; not freestanding
- Radius 24" deep (left) end connects with 42" corner module
- 30" deep right
- Two half legs
- Two grommets in modesty and one in each half leg
- Assembly required

Support legs on 72", 66" and 60" lengths should be relocated inward (12" from either end) for increased worksurface support

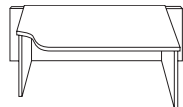

Support leg on 48", 42", 36" and 30" lengths located close to ends

Freight Class: 125

<b>HW_247230RH</b>	72" X 30" X 29"	Cubic Ft: 7.16	Ship Weight: 150	<b>705</b>	<b>716</b>	<b>726</b>
<b>HW_246630RH</b>	66" X 30" X 29"	Cubic Ft: 6.2	Ship Weight: 137	<b>684</b>	<b>694</b>	<b>705</b>
<b>HW_246030RH</b>	60" X 30" X 29"	Cubic Ft: 6	Ship Weight: 125	<b>658</b>	<b>668</b>	<b>678</b>

<b>HW_244830RH</b>	48" X 30" X 29"	Cubic Ft: 4.9	Ship Weight: 100	<b>610</b>	<b>619</b>	<b>628</b>
<b>HW_244230RH</b>	42" X 30" X 29"	Cubic Ft: 4.9	Ship Weight: 87	<b>579</b>	<b>588</b>	<b>596</b>
<b>HW_243630RH</b>	36" X 30" X 29"	Cubic Ft: 4.01	Ship Weight: 75	<b>551</b>	<b>559</b>	<b>568</b>
<b>HW_243030RH</b>	30" X 30" X 29"	Cubic Ft: 4.01	Ship Weight: 62	<b>521</b>	<b>529</b>	<b>537</b>

## Asymmetrical Shells, 24" Deep

### Left Asymmetrical Shell

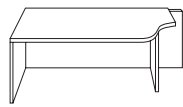
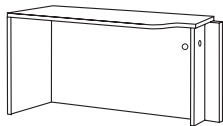

- Radius 19" deep (right) end connects with 36" corner module
- 24" deep left
- Full left, half right leg
- Grommet in modesty panel and half leg

Half-depth support leg on 72", 66", 60" and 54" lengths should be relocated inward (12" from end) for increased worksurface support

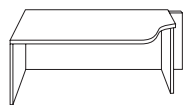

Support leg on 48", 42", 36" and 30" lengths located close to ends

Freight Class: 200

<b>HW_197224L</b>	72" X 24" X 29"	Cubic Ft: 35.7	Ship Weight: 165	<b>647</b>	<b>657</b>	<b>666</b>
<b>HW_196624L</b>	66" X 24" X 29"	Cubic Ft: 32	Ship Weight: 155	<b>619</b>	<b>628</b>	<b>638</b>
<b>HW_196024L</b>	60" X 24" X 29"	Cubic Ft: 30.5	Ship Weight: 145	<b>599</b>	<b>608</b>	<b>617</b>
<b>HW_195424L</b>	54" X 24" X 29"	Cubic Ft: 27.6	Ship Weight: 135	<b>518</b>	<b>590</b>	<b>598</b>

<b>HW_194824L</b>	48" X 24" X 29"	Cubic Ft: 24.3	Ship Weight: 125	<b>569</b>	<b>578</b>	<b>586</b>
<b>HW_194224L</b>	42" X 24" X 29"	Cubic Ft: 21.7	Ship Weight: 115	<b>541</b>	<b>549</b>	<b>557</b>
<b>HW_193624L</b>	36" X 24" X 29"	Cubic Ft: 19.8	Ship Weight: 105	<b>519</b>	<b>527</b>	<b>535</b>
<b>HW_193024L</b>	30" X 24" X 29"	Cubic Ft: 19.8	Ship Weight: 95	<b>484</b>	<b>491</b>	<b>499</b>

## FINISH SELECTION

NATURAL MAPLE **FM** | WINDSOR CHERRY **WC** | MAHOGANY **M** |  
 GRAPHITE **GP** | MEDIUM OAK **O** | ASPEN **AP** | PEARWOOD **PW** |  
 BLACK **E** | ESPRESSO **X** | GREY **G** | CLASSIC CHERRY **CC** |

# SIN 711-2 HYPERWORK

### Right Asymmetrical Shell



- Radius 19" deep (left) end connects with 36" corner module
- 24" deep right
- Full right, half left leg
- Grommet in modesty panel and half leg

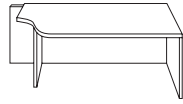

Half-depth support leg on 72", 66", 60" and 54" lengths should be relocated inward (12" from end) for increased worksurface support

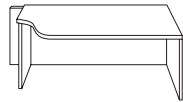

Support leg on 48", 42", 36" and 30" lengths located close to ends

Freight Class: 200

### Left Asymmetrical Bridge/Shell

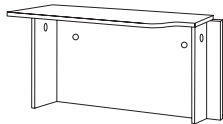

- Connects at both ends; not freestanding
- Radius 19" deep (right) end connects with 36" corner module
- 24" deep left
- Two half legs
- Two grommets in modesty and one in each half leg
- Assembly required

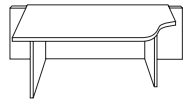

Half-depth support leg on 72", 66" and 60" lengths should be relocated inward (12" from end) for increased worksurface support

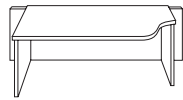

Support leg on 48", 42", 36" and 30" lengths located close to ends

Freight Class: 125

### Right Asymmetrical Bridge/Shell

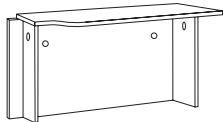

- Connects at both ends; not freestanding
- Radius 19" deep (left) end connects with 36" corner module
- 24" deep right
- Two half legs
- Two grommets in modesty and one in each half leg
- Assembly required

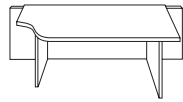

Half-depth support leg on 72", 66" and 60" lengths should be relocated inward (12" from end) for increased worksurface support

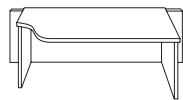

Support leg on 48", 42", 36" and 30" lengths located close to ends

Freight Class: 125

				Zone Pricing	1	2	3
<b>HW_197224R</b>	72" X 24" X 29"	Cubic Ft: 35.7	Ship Weight: 165		<b>647</b>	<b>657</b>	<b>666</b>
<b>HW_196624R</b>	66" X 24" X 29"	Cubic Ft: 32	Ship Weight: 155		<b>619</b>	<b>628</b>	<b>638</b>
<b>HW_196024R</b>	60" X 24" X 29"	Cubic Ft: 30.5	Ship Weight: 145		<b>599</b>	<b>608</b>	<b>617</b>
<b>HW_195424R</b>	54" X 24" X 29"	Cubic Ft: 27.6	Ship Weight: 135		<b>518</b>	<b>590</b>	<b>598</b>

<b>HW_194824R</b>	48" X 24" X 29"	Cubic Ft: 24.3	Ship Weight: 125		<b>569</b>	<b>578</b>	<b>586</b>
<b>HW_194224R</b>	42" X 24" X 29"	Cubic Ft: 21.7	Ship Weight: 115		<b>541</b>	<b>549</b>	<b>557</b>
<b>HW_193624R</b>	36" X 24" X 29"	Cubic Ft: 19.8	Ship Weight: 105		<b>519</b>	<b>527</b>	<b>535</b>
<b>HW_193024R</b>	30" X 24" X 29"	Cubic Ft: 19.8	Ship Weight: 95		<b>484</b>	<b>491</b>	<b>499</b>

<b>HW_197224LH</b>	72" X 24" X 29"	Cubic Ft: 5.8	Ship Weight: 144		<b>647</b>	<b>657</b>	<b>666</b>
<b>HW_196624LH</b>	66" X 24" X 29"	Cubic Ft: 5.4	Ship Weight: 132		<b>619</b>	<b>628</b>	<b>638</b>
<b>HW_196024LH</b>	60" X 24" X 29"	Cubic Ft: 4.9	Ship Weight: 120		<b>599</b>	<b>608</b>	<b>617</b>

<b>HW_194824LH</b>	48" X 24" X 29"	Cubic Ft: 3.9	Ship Weight: 96		<b>569</b>	<b>578</b>	<b>586</b>
<b>HW_194224LH</b>	42" X 24" X 29"	Cubic Ft: 3.5	Ship Weight: 84		<b>541</b>	<b>549</b>	<b>557</b>
<b>HW_193624LH</b>	36" X 24" X 29"	Cubic Ft: 3	Ship Weight: 72		<b>519</b>	<b>527</b>	<b>535</b>
<b>HW_193024LH</b>	30" X 24" X 29"	Cubic Ft: 3	Ship Weight: 60		<b>484</b>	<b>491</b>	<b>499</b>

<b>HW_197224RH</b>	72" X 24" X 29"	Cubic Ft: 5.8	Ship Weight: 144		<b>647</b>	<b>657</b>	<b>666</b>
<b>HW_196624RH</b>	66" X 24" X 29"	Cubic Ft: 5.4	Ship Weight: 132		<b>619</b>	<b>628</b>	<b>638</b>
<b>HW_196024RH</b>	60" X 24" X 29"	Cubic Ft: 4.9	Ship Weight: 120		<b>599</b>	<b>608</b>	<b>617</b>

<b>HW_194824RH</b>	48" X 24" X 29"	Cubic Ft: 3.9	Ship Weight: 96		<b>569</b>	<b>578</b>	<b>586</b>
<b>HW_194224RH</b>	42" X 24" X 29"	Cubic Ft: 3.5	Ship Weight: 84		<b>541</b>	<b>549</b>	<b>557</b>
<b>HW_193624RH</b>	36" X 24" X 29"	Cubic Ft: 3	Ship Weight: 72		<b>519</b>	<b>527</b>	<b>535</b>
<b>HW_193024RH</b>	30" X 24" X 29"	Cubic Ft: 3	Ship Weight: 60		<b>484</b>	<b>491</b>	<b>499</b>

CONTEMPORARY LAMINATE



## Rectangular Shells, 30" Deep

Zone Pricing

1

2

3

### Freestanding Rectangular Shell

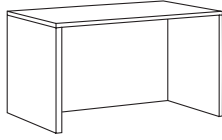

- Freestanding
- Two full legs
- Utility and mobile pedestals available

Product Code	Dimensions	Cubic Ft.	Ship Weight	Zone 1	Zone 2	Zone 3
<b>HW_RS3072</b>	72" X 30" X 29"	44.4	200	<b>663</b>	<b>673</b>	<b>683</b>
Freight Class: 200						
<b>HW_RS3066</b>	66" X 30" X 29"	40.2	192	<b>643</b>	<b>653</b>	<b>662</b>
Freight Class: 200						
<b>HW_RS3060</b>	60" X 30" X 29"	36.7	184	<b>613</b>	<b>622</b>	<b>631</b>
Freight Class: 200						
<b>HW_RS3048</b>	48" X 30" X 29"	30.1	179	<b>566</b>	<b>574</b>	<b>583</b>
Freight Class: 110						
<b>HW_RS3042</b>	42" X 30" X 29"	30.1	171	<b>529</b>	<b>537</b>	<b>545</b>
Freight Class: 110						
<b>HW_RS3036</b>	36" X 30" X 29"	23	163	<b>508</b>	<b>516</b>	<b>523</b>
Freight Class: 110						
<b>HW_RS3030</b>	30" X 30" X 29"	23	155	<b>481</b>	<b>488</b>	<b>495</b>
Freight Class: 110						

### Rectangular Bridge/Shell

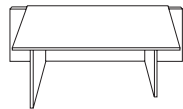
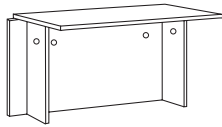

- Connects at both ends; not freestanding
- Two half legs
- Two grommets in modesty and one in each half leg
- Assembly required

Half-depth support leg on 72", 66" and 60" lengths should be relocated inward (12" from end) for increased worksurface support

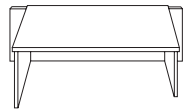

Support leg on 48", 42", 36" and 30" lengths located close to ends

Freight Class: 125

<b>HW_RS3072H</b>	72" X 30" X 29"	7.2	154	<b>663</b>	<b>673</b>	<b>683</b>
<b>HW_RS3066H</b>	66" X 30" X 29"	6.2	141	<b>643</b>	<b>653</b>	<b>662</b>
<b>HW_RS3060H</b>	60" X 30" X 29"	6	129	<b>613</b>	<b>622</b>	<b>631</b>

<b>HW_RS3048H</b>	48" X 30" X 29"	30.1	179	<b>566</b>	<b>574</b>	<b>583</b>
<b>HW_RS3042H</b>	42" X 30" X 29"	30.1	171	<b>529</b>	<b>537</b>	<b>545</b>
<b>HW_RS3036H</b>	36" X 30" X 29"	23	163	<b>508</b>	<b>516</b>	<b>523</b>
<b>HW_RS3030H</b>	30" X 30" X 29"	23	155	<b>481</b>	<b>488</b>	<b>495</b>

### Left Rectangular Shell

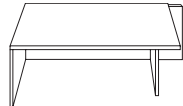
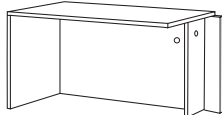

- Connect with straight edge; not freestanding
- Full left, half right leg
- Grommet in half leg and modesty panel

Half-depth support leg on 72", 66" and 60" lengths should be relocated inward (12" from end) for increased worksurface support

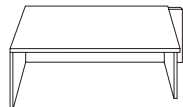

Support leg on 48", 42", 36" and 30" lengths located close to ends

Freight Class: 200

<b>HW_RS3072L</b>	72" X 30" X 29"	44.4	179	<b>663</b>	<b>673</b>	<b>683</b>
<b>HW_RS3066L</b>	66" X 30" X 29"	40.2	169	<b>643</b>	<b>653</b>	<b>662</b>
<b>HW_RS3060L</b>	60" X 30" X 29"	36.7	159	<b>613</b>	<b>622</b>	<b>631</b>

<b>HW_RS3048L</b>	48" X 30" X 29"	30.1	133	<b>566</b>	<b>574</b>	<b>583</b>
<b>HW_RS3042L</b>	42" X 30" X 29"	30.1	129	<b>529</b>	<b>537</b>	<b>545</b>
<b>HW_RS3036L</b>	36" X 30" X 29"	23	119	<b>508</b>	<b>516</b>	<b>523</b>
<b>HW_RS3030L</b>	30" X 30" X 29"	23	109	<b>481</b>	<b>488</b>	<b>495</b>



## FINISH SELECTION

NATURAL MAPLE **FM** | WINDSOR CHERRY **WC** | MAHOGANY **M** |  
 GRAPHITE **GP** | MEDIUM OAK **O** | ASPEN **AP** | PEARWOOD **PW** |  
 BLACK **E** | ESPRESSO **X** | GREY **G** | CLASSIC CHERRY **CC** |

# SIN 711-2 HYPERWORK

### Right Rectangular Shell

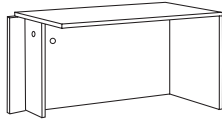

- Connect with straight edge; not freestanding
- Full right, half left leg
- Grommet in half leg and modesty panel

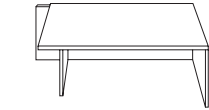

Half-depth support leg on 72", 66" and 60" lengths should be relocated inward (12" from end) for increased worksurface support

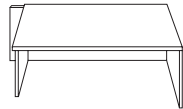

Support leg on 48", 42", 36" and 30" lengths located close to ends

Freight Class: 200

				Zone Pricing	1	2	3
<b>HW_RS3072R</b>	72" X 30" X 29"	Cubic Ft: 44.4	Ship Weight: 179	<b>663</b>	<b>673</b>	<b>683</b>	
<b>HW_RS3066R</b>	66" X 30" X 29"	Cubic Ft: 40.2	Ship Weight: 169	<b>643</b>	<b>653</b>	<b>662</b>	
<b>HW_RS3060R</b>	60" X 30" X 29"	Cubic Ft: 36.7	Ship Weight: 159	<b>613</b>	<b>622</b>	<b>631</b>	

<b>HW_RS3048R</b>	48" X 30" X 29"	Cubic Ft: 30.1	Ship Weight: 133	<b>566</b>	<b>574</b>	<b>583</b>
<b>HW_RS3042R</b>	42" X 30" X 29"	Cubic Ft: 30.1	Ship Weight: 129	<b>529</b>	<b>537</b>	<b>545</b>
<b>HW_RS3036R</b>	36" X 30" X 29"	Cubic Ft: 23	Ship Weight: 119	<b>508</b>	<b>516</b>	<b>523</b>
<b>HW_RS3030R</b>	30" X 30" X 29"	Cubic Ft: 23	Ship Weight: 109	<b>481</b>	<b>488</b>	<b>495</b>

### Rectangular Shells, 24" Deep

#### Right Running Credenza Shell

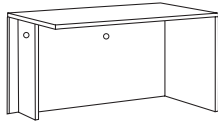

- Connects with return/shell on left
- Use to create straight, continuous work area
- 1" thick back panel
- Full right, half left leg
- One grommet in modesty panel and one in support leg

Freight Class: 200

<b>HW_RR2472R</b>	72" X 24" X 29"	Cubic Ft: 35.7	Ship Weight: 160	<b>724</b>	<b>735</b>	<b>746</b>
<b>HW_RR2466R</b>	66" X 24" X 29"	Cubic Ft: 32	Ship Weight: 154	<b>713</b>	<b>724</b>	<b>734</b>
<b>HW_RR2460R</b>	60" X 24" X 29"	Cubic Ft: 30.5	Ship Weight: 149	<b>690</b>	<b>700</b>	<b>711</b>
<b>HW_RR2448R</b>	48" X 24" X 29"	Cubic Ft: 24.3	Ship Weight: 135	<b>666</b>	<b>676</b>	<b>686</b>
<b>HW_RR2442R</b>	42" X 24" X 29"	Cubic Ft: 21.7	Ship Weight: 119	<b>593</b>	<b>602</b>	<b>611</b>

#### Left Running Credenza Shell

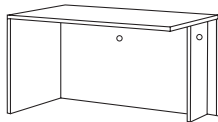

- Same description as above except:
- Connects with return/shell on right
- Full left, half right leg

Freight Class: 200

<b>HW_RR2472L</b>	72" X 24" X 29"	Cubic Ft: 35.7	Ship Weight: 160	<b>724</b>	<b>735</b>	<b>746</b>
<b>HW_RR2466L</b>	66" X 24" X 29"	Cubic Ft: 32	Ship Weight: 154	<b>713</b>	<b>724</b>	<b>734</b>
<b>HW_RR2460L</b>	60" X 24" X 29"	Cubic Ft: 30.5	Ship Weight: 149	<b>690</b>	<b>700</b>	<b>711</b>
<b>HW_RR2448L</b>	48" X 24" X 29"	Cubic Ft: 24.3	Ship Weight: 135	<b>666</b>	<b>676</b>	<b>686</b>
<b>HW_RR2442L</b>	42" X 24" X 29"	Cubic Ft: 21.7	Ship Weight: 119	<b>593</b>	<b>602</b>	<b>611</b>

#### Freestanding Rectangular Shell

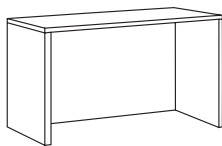

- Freestanding
- Two full legs
- Utility and mobile pedestals available

Freight Class: 200

<b>HW_RS2472</b>	72" X 24" X 29"	Cubic Ft: 35.7	Ship Weight: 169	<b>663</b>	<b>673</b>	<b>683</b>
<b>HW_RS2466</b>	66" X 24" X 29"	Cubic Ft: 32	Ship Weight: 159	<b>643</b>	<b>653</b>	<b>662</b>
<b>HW_RS2460</b>	60" X 24" X 29"	Cubic Ft: 30.5	Ship Weight: 149	<b>613</b>	<b>622</b>	<b>631</b>
<b>HW_RS2454</b>	54" X 24" X 29"	Cubic Ft: 27.6	Ship Weight: 139	<b>573</b>	<b>582</b>	<b>590</b>
<b>HW_RS2448</b>	48" X 24" X 29"	Cubic Ft: 24.3	Ship Weight: 129	<b>566</b>	<b>574</b>	<b>583</b>
<b>HW_RS2442</b>	42" X 24" X 29"	Cubic Ft: 21.7	Ship Weight: 119	<b>529</b>	<b>537</b>	<b>545</b>
<b>HW_RS2436</b>	36" X 24" X 29"	Cubic Ft: 19.8	Ship Weight: 109	<b>508</b>	<b>516</b>	<b>523</b>
<b>HW_RS2430</b>	30" X 24" X 29"	Cubic Ft: 19.8	Ship Weight: 99	<b>481</b>	<b>488</b>	<b>495</b>

CONTEMPORARY LAMINATE



Zone Pricing	1	2	3
--------------	---	---	---

### Rectangular Bridge/Shell

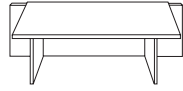
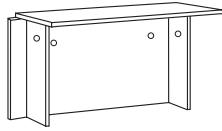

- Connects at both ends; not freestanding
- Two half legs
- Two grommets in modesty panel and one in each half leg
- Assembly required

Half-depth support leg on 72", 66" and 60" lengths should be relocated inward (12" from end) for increased worksurface support

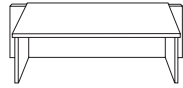

Support leg on 48", 42", 36" and 30" lengths located close to ends

Freight Class: 125

<b>HW_RS2472H</b>	72" X 24" X 29"	Cubic Ft: 5.8	Ship Weight: 149	<b>663</b>	<b>673</b>	<b>683</b>
<b>HW_RS2466H</b>	66" X 24" X 29"	Cubic Ft: 5.4	Ship Weight: 136	<b>643</b>	<b>653</b>	<b>662</b>
<b>HW_RS2460H</b>	60" X 24" X 29"	Cubic Ft: 4.9	Ship Weight: 124	<b>613</b>	<b>622</b>	<b>631</b>

<b>HW_RS2448H</b>	48" X 24" X 29"	Cubic Ft: 3.9	Ship Weight: 100	<b>566</b>	<b>574</b>	<b>583</b>
<b>HW_RS2442H</b>	42" X 24" X 29"	Cubic Ft: 3.5	Ship Weight: 88	<b>529</b>	<b>537</b>	<b>545</b>
<b>HW_RS2436H</b>	36" X 24" X 29"	Cubic Ft: 3	Ship Weight: 76	<b>508</b>	<b>516</b>	<b>523</b>
<b>HW_RS2430H</b>	30" X 24" X 29"	Cubic Ft: 3	Ship Weight: 64	<b>481</b>	<b>488</b>	<b>495</b>

### Left Rectangular Shell

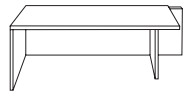
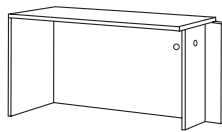

- Connect with straight edge; not freestanding
- Full left, half right leg
- Grommet in modesty panel and half leg

Half-depth support leg on 72", 66", 60" and 54" lengths should be relocated inward (12" from end) for increased worksurface support

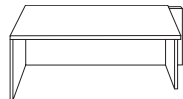

Support leg on 48", 42", 36" and 30" lengths located close to ends

Freight Class: 200

<b>HW_RS2472L</b>	72" X 24" X 29"	Cubic Ft: 35.7	Ship Weight: 169	<b>663</b>	<b>673</b>	<b>683</b>
-------------------	-----------------	----------------	------------------	------------	------------	------------

Freight Class: 200

<b>HW_RS2466L</b>	66" X 24" X 29"	Cubic Ft: 32	Ship Weight: 159	<b>643</b>	<b>653</b>	<b>662</b>
-------------------	-----------------	--------------	------------------	------------	------------	------------

Freight Class: 200

<b>HW_RS2460L</b>	60" X 24" X 29"	Cubic Ft: 30.5	Ship Weight: 149	<b>613</b>	<b>622</b>	<b>631</b>
-------------------	-----------------	----------------	------------------	------------	------------	------------

Freight Class: 200

<b>HW_RS2454L</b>	54" X 24" X 29"	Cubic Ft: 27.6	Ship Weight: 138	<b>573</b>	<b>582</b>	<b>590</b>
-------------------	-----------------	----------------	------------------	------------	------------	------------

Freight Class: 200

<b>HW_RS2448L</b>	48" X 24" X 29"	Cubic Ft: 24.3	Ship Weight: 129	<b>566</b>	<b>574</b>	<b>583</b>
-------------------	-----------------	----------------	------------------	------------	------------	------------

Freight Class: 200

<b>HW_RS2442L</b>	42" X 24" X 29"	Cubic Ft: 21.7	Ship Weight: 119	<b>529</b>	<b>537</b>	<b>545</b>
-------------------	-----------------	----------------	------------------	------------	------------	------------

Freight Class: 200

<b>HW_RS2436L</b>	36" X 24" X 29"	Cubic Ft: 19.8	Ship Weight: 109	<b>508</b>	<b>516</b>	<b>523</b>
-------------------	-----------------	----------------	------------------	------------	------------	------------

Freight Class: 110

<b>HW_RS2430L</b>	30" X 24" X 29"	Cubic Ft: 19.8	Ship Weight: 99	<b>481</b>	<b>488</b>	<b>495</b>
-------------------	-----------------	----------------	-----------------	------------	------------	------------

Freight Class: 200

### Right Rectangular Shell

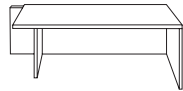
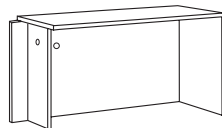

- Connect with straight edge; not freestanding
- Full right, half left leg
- Grommet in modesty panel and half leg

Half-depth support leg on 72", 66", 60" and 54" lengths should be relocated inward (12" from end) for increased worksurface support

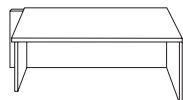

Support leg on 48", 42", 36" and 30" lengths located close to ends

<b>HW_RS2472R</b>	72" X 24" X 29"	Cubic Ft: 35.7	Ship Weight: 169	<b>663</b>	<b>673</b>	<b>683</b>
-------------------	-----------------	----------------	------------------	------------	------------	------------

Freight Class: 200

<b>HW_RS2466R</b>	66" X 24" X 29"	Cubic Ft: 32	Ship Weight: 159	<b>643</b>	<b>653</b>	<b>662</b>
-------------------	-----------------	--------------	------------------	------------	------------	------------

Freight Class: 200

<b>HW_RS2460R</b>	60" X 24" X 29"	Cubic Ft: 30.5	Ship Weight: 149	<b>613</b>	<b>622</b>	<b>631</b>
-------------------	-----------------	----------------	------------------	------------	------------	------------

Freight Class: 200

<b>HW_RS2454R</b>	54" X 24" X 29"	Cubic Ft: 27.6	Ship Weight: 138	<b>573</b>	<b>582</b>	<b>590</b>
-------------------	-----------------	----------------	------------------	------------	------------	------------

Freight Class: 200

<b>HW_RS2448R</b>	48" X 24" X 29"	Cubic Ft: 24.3	Ship Weight: 129	<b>566</b>	<b>574</b>	<b>583</b>
-------------------	-----------------	----------------	------------------	------------	------------	------------

Freight Class: 200

<b>HW_RS2442R</b>	42" X 24" X 29"	Cubic Ft: 21.7	Ship Weight: 119	<b>529</b>	<b>537</b>	<b>545</b>
-------------------	-----------------	----------------	------------------	------------	------------	------------

Freight Class: 200

<b>HW_RS2436R</b>	36" X 24" X 29"	Cubic Ft: 19.8	Ship Weight: 109	<b>508</b>	<b>516</b>	<b>523</b>
-------------------	-----------------	----------------	------------------	------------	------------	------------

Freight Class: 110

<b>HW_RS2430R</b>	30" X 24" X 29"	Cubic Ft: 19.8	Ship Weight: 99	<b>481</b>	<b>488</b>	<b>495</b>
-------------------	-----------------	----------------	-----------------	------------	------------	------------

Freight Class: 200

## FINISH SELECTION

NATURAL MAPLE **FM** | WINDSOR CHERRY **WC** | MAHOGANY **M** | GRAPHITE **GP** | MEDIUM OAK **O** | ASPEN **AP** | PEARWOOD **PW** | BLACK **E** | ESPRESSO **X** | GREY **G** | CLASSIC CHERRY **CC** |

# SIN 711-2 HYPERWORK

## Modular Filing

Zone Pricing

1

2

3

### Box/File Utility Pedestal



- 3/4 height pedestal for field installation
- Pre-installed, black filing hardware
- Legal or letter filing
- Single-key front locking

Freight Class: 100

**H\_UP QS** 15.75" x 22" x 17.75" Cubic Ft: 7 Ship Weight: 61 **575** **584** **592**

**Pulls:** BRUSHED CHROME **HW** EBONY **HE** BRIGHT BRASS **HB** OVAL NICKEL **HD**

**QS FINISHES WC**

**QS PULLS W**

### Box/Box/File Utility Pedestal



- Full-to-floor pedestal for field installation
- Pre-installed, black filing hardware
- Legal or letter filing
- Single-key front locking

Freight Class: 100

**H\_UP2BF** 15.75" x 22" x 27.25" Cubic Ft: 10.1 Ship Weight: 83 **694** **704** **715**

**Pulls:** BRUSHED CHROME **HW** EBONY **HE** BRIGHT BRASS **HB** OVAL NICKEL **HD**

### File/File Utility Pedestal



- Full-to-floor pedestal for field installation
- Pre-installed, black filing hardware
- Legal or letter filing
- Single-key front locking

Freight Class: 100

**H\_UPF** 15.75" x 22" x 27.25" Cubic Ft: 10.1 Ship Weight: 83 **694** **704** **715**

**Pulls:** BRUSHED CHROME **HW** EBONY **HE** BRIGHT BRASS **HB** OVAL NICKEL **HD**

### Lateral File Utility Pedestal



- Full-to-floor pedestal for field installation
- Pre-installed, black filing hardware
- Legal or letter filing
- Single-key front locking

Freight Class: 100

**H\_ULF** 30.5" x 22" x 27.25" Cubic Ft: 19.8 Ship Weight: 165 **872** **885** **898**

**Pulls:** BRUSHED CHROME **HW** EBONY **HE** BRIGHT BRASS **HB** OVAL NICKEL **HD**

## Reception Stations

### Left Pedestal Reception Desk

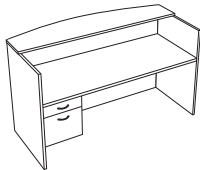

- 42" privacy height
- 18" bow front transaction counter
- Box/File left pedestal
- Pre-installed, black filing hardware
- Legal or letter filing
- Single-key locking

Freight Class: 200

**H\_7230L QS** 72" x 36" x 42" Cubic Ft: 63.9 Ship Weight: 343 **1559** **1582** **1606**

**Center Drawer C** 165 167 170

**Keyboard Platform K** 196 199 202

**Pulls:** BRUSHED CHROME **HW** EBONY **HE** BRIGHT BRASS **HB** OVAL NICKEL **HD**

**QS FINISHES WC**

**QS PULLS W**

### Right Pedestal Reception Desk

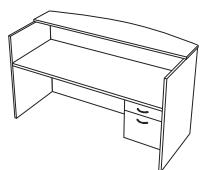

- Same description as above except:
- Box/File right pedestal

Freight Class: 200

**H\_7230R QS** 72" x 36" x 42" Cubic Ft: 63.9 Ship Weight: 343 **1559** **1582** **1606**

**Center Drawer C** 165 167 170

**Keyboard Platform K** 196 199 202

**Pulls:** BRUSHED CHROME **HW** EBONY **HE** BRIGHT BRASS **HB** OVAL NICKEL **HD**

**QS FINISHES WC**

**QS PULLS W**

CONTEMPORARY LAMINATE



H	W	FM	2442L
Pull		Finish	

Zone Pricing	1	2	3
--------------	---	---	---

### Left Pedestal Reception Return

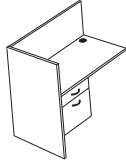

- 41" privacy height
- Box/File left pedestal
- Pre-installed, black filing hardware
- Legal or letter filing
- Grommet in top and modesty panel
- Single-key locking

Freight Class: 110

<b>H_2442L QS</b>	42" x 24" x 41" Cubic Ft: 32.9 Ship Weight: 195	<b>1040</b>	<b>1056</b>	<b>1071</b>
<b>Keyboard Platform K</b>		196	199	202

<b>Pulls:</b>	BRUSHED CHROME <b>HW</b>	EBONY <b>HE</b>	BRIGHT BRASS <b>HB</b>	OVAL NICKEL <b>HD</b>
---------------	--------------------------	-----------------	------------------------	-----------------------

<b>QS FINISHES</b>	<b>WC</b>	<b>QS PULLS</b>	<b>W</b>
--------------------	-----------	-----------------	----------

### Right Pedestal Reception Return

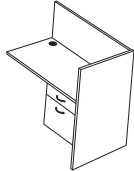

- Same description as above except:
- Box/File right pedestal

Freight Class: 110

<b>H_2442R QS</b>	42" x 24" x 41" Cubic Ft: 32.9 Ship Weight: 195	<b>1040</b>	<b>1056</b>	<b>1071</b>
<b>Keyboard Platform K</b>		196	199	202

<b>Pulls:</b>	BRUSHED CHROME <b>HW</b>	EBONY <b>HE</b>	BRIGHT BRASS <b>HB</b>	OVAL NICKEL <b>HD</b>
---------------	--------------------------	-----------------	------------------------	-----------------------

<b>QS FINISHES</b>	<b>WC</b>	<b>QS PULLS</b>	<b>W</b>
--------------------	-----------	-----------------	----------

### Left Full Pedestal Reception Desk



- 42" privacy height
- 18" bow front transaction counter (field installed)
- Box/Box/File left pedestal
- Pre-installed, black filing hardware
- Legal or letter filing
- Single-key locking

Freight Class: 110

<b>H_7230L2BF</b>	72" x 36" x 42" Cubic Ft: 63.9 Ship Weight: 368	<b>1853</b>	<b>1881</b>	<b>1909</b>
<b>Center Drawer C</b>		165	167	170
<b>Keyboard Platform K</b>		196	199	202

<b>Pulls:</b>	BRUSHED CHROME <b>HW</b>	EBONY <b>HE</b>	BRIGHT BRASS <b>HB</b>	OVAL NICKEL <b>HD</b>
---------------	--------------------------	-----------------	------------------------	-----------------------

### Right Full Pedestal Reception Desk

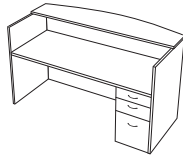

- Same description as above except:
- Box/Box/File right pedestal

Freight Class: 110

<b>H_7230R2BF</b>	72" x 36" x 42" Cubic Ft: 63.9 Ship Weight: 368	<b>1853</b>	<b>1881</b>	<b>1909</b>
<b>Center Drawer C</b>		165	167	170
<b>Keyboard Platform K</b>		196	199	202

<b>Pulls:</b>	BRUSHED CHROME <b>HW</b>	EBONY <b>HE</b>	BRIGHT BRASS <b>HB</b>	OVAL NICKEL <b>HD</b>
---------------	--------------------------	-----------------	------------------------	-----------------------

### Left Full Pedestal Reception Return



- 41" privacy height
- File/File left pedestal
- Pre-installed, black filing hardware
- Legal or letter filing
- Grommet in top and modesty panel
- Single-key locking

Freight Class: 110

<b>H_2442LF</b>	42" x 24" x 41" Cubic Ft: 32.9 Ship Weight: 220	<b>1218</b>	<b>1236</b>	<b>1255</b>
<b>Keyboard Platform K</b>		196	199	202

<b>Pulls:</b>	BRUSHED CHROME <b>HW</b>	EBONY <b>HE</b>	BRIGHT BRASS <b>HB</b>	OVAL NICKEL <b>HD</b>
---------------	--------------------------	-----------------	------------------------	-----------------------

### Right Full Pedestal Reception Return

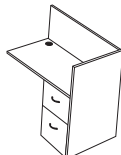

- Same description as above except:
- File/File right pedestal

Freight Class: 110

<b>H_2442RF</b>	42" x 24" x 41" Cubic Ft: 32.9 Ship Weight: 220	<b>1218</b>	<b>1236</b>	<b>1255</b>
<b>Keyboard Platform K</b>		196	199	202

<b>Pulls:</b>	BRUSHED CHROME <b>HW</b>	EBONY <b>HE</b>	BRIGHT BRASS <b>HB</b>	OVAL NICKEL <b>HD</b>
---------------	--------------------------	-----------------	------------------------	-----------------------

## FINISH SELECTION

NATURAL MAPLE **FM** | WINDSOR CHERRY **WC** | MAHOGANY **M** | GRAPHITE **GP** | MEDIUM OAK **O** | ASPEN **AP** | PEARWOOD **PW** | BLACK **E** | ESPRESSO **X** | GREY **G** | CLASSIC CHERRY **CC** |

# SIN 711-2 HYPERWORK

### Reception Screen for Main

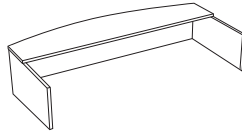

- HW\_710 fits 72" x 30" desks
- HW\_610 fits 66" x 30" desks
- 18" bow front transaction counter
- Non-skid rubber strips on bottom prohibit movement

Freight Class: 70

### Reception Screen for Return



- Fits 42" x 24" executive height return
- Hardware included to join to main reception screen
- HW\_611L fits left return
- HW\_611R fits right return
- Assembly required

Freight Class: 70

## Overhead Storage & Hutches

### Overhead Storage Unit, Aluminum/Frosted Doors

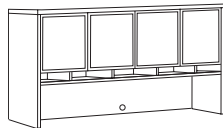

- Two storage compartments
- Four aluminum/frosted doors
- Five paper storage shelves
- 18-1/2" monitor clearance under cabinet
- Grommet in back panel

Freight Class: 125

### Overhead Storage Unit

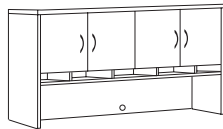

- Two storage compartments
- Four doors
- Five paper storage shelves
- 18-1/2" monitor clearance under cabinet
- Grommet in back panel

Freight Class: 125

### Overhead Storage Unit

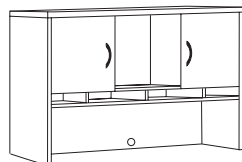

- Two compartments with doors
- Center open storage
- Four paper storage shelves
- 18-1/2" monitor clearance under cabinet
- Grommet in back panel

Freight Class: 125

				Zone Pricing	1	2	3
<b>HW_710</b>	72" x 36" x 14"	Cubic Ft: 33.6	Ship Weight: 150		<b>965</b>	<b>979</b>	<b>994</b>
<b>HW_610</b>	66" x 36" x 14"	Cubic Ft: 28.9	Ship Weight: 129		<b>933</b>	<b>947</b>	<b>961</b>
<b>HW_611L</b>	42" x 24" x 13"	Cubic Ft: 1.5	Ship Weight: 27		<b>214</b>	<b>217</b>	<b>220</b>
<b>HW_611R</b>	42" x 24" x 13"	Cubic Ft: 1.5	Ship Weight: 27		<b>214</b>	<b>217</b>	<b>220</b>
<b>HW_738AD</b>	72" x 16" x 36.5"	Cubic Ft: 33.6	Ship Weight: 235		<b>2233</b>	<b>2266</b>	<b>2300</b>
				<b>Task Light T</b>	\$124	\$126	\$128
				<b>LED Task Light L</b>	\$124	\$126	\$128
<b>H_738</b>	72" x 16" x 36.5"	Cubic Ft: 33.6	Ship Weight: 240		<b>1529</b>	<b>1552</b>	<b>1575</b>
				<b>Task Light T</b>	\$124	\$126	\$128
				<b>LED Task Light L</b>	\$212	\$215	\$218
<b>H_678</b>	66" x 16" x 36.5"	Cubic Ft: 28.3	Ship Weight: 215		<b>1278</b>	<b>1297</b>	<b>1316</b>
				<b>Task Light T</b>	\$124	\$126	\$128
				<b>LED Task Light TLED</b>	\$212	\$215	\$218
<b>H_676</b>	60" x 16" x 36.5"	Cubic Ft: 28.3	Ship Weight: 200		<b>1262</b>	<b>1281</b>	<b>1300</b>
				<b>Task Light T</b>	\$124	\$126	\$128
				<b>LED Task Light L</b>	\$212	\$215	\$218
<b>H_538</b>	54" x 16" x 36.5"	Cubic Ft: 24.3	Ship Weight: 180		<b>1247</b>	<b>1266</b>	<b>1284</b>
				<b>Task Light T</b>	\$124	\$126	\$128
				<b>LED Task Light L</b>	\$212	\$215	\$218

**Pulls:** BRUSHED CHROME **HW** | EBONY **HE** | BRIGHT BRASS **HB** | OVAL NICKEL **HD**

**Locks** \$150 :Y

**Pulls:** BRUSHED CHROME **HW** | EBONY **HE** | BRIGHT BRASS **HB** | OVAL NICKEL **HD**

**Locks** \$150 :Y

CONTEMPORARY LAMINATE



HW FM 476	
Pull	Finish

### Overhead Storage Unit



- Storage compartment
- Two doors
- Three paper storage shelves
- 18-1/2" monitor clearance under cabinet
- Grommet in back panel

		Zone Pricing	1	2	3
<b>H_476</b>	42" x 16" x 36.5" Cubic Ft: 24.3 Ship Weight: 163		<b>934</b>	<b>948</b>	<b>962</b>
	<b>Task Light T</b>		\$124	\$126	\$128
	<b>LED Task Light L</b>		\$212	\$215	\$218
<b>H_338</b>	36" x 16" x 36.5" Cubic Ft: 15.3 Ship Weight: 145		<b>901</b>	<b>915</b>	<b>928</b>
	<b>Task Light T</b>		\$124	\$126	\$128
	<b>LED Task Light L</b>		\$212	\$215	\$218
<b>H_336</b>	30" x 16" x 36.5" Cubic Ft: 15.3 Ship Weight: 140		<b>848</b>	<b>861</b>	<b>873</b>
	<b>Task Light T</b>		\$124	\$126	\$128
	<b>LED Task Light L</b>		\$212	\$215	\$218

<b>Pulls:</b>	BRUSHED CHROME <b>HW</b>	EBONY <b>HE</b>	BRIGHT BRASS <b>HB</b>	OVAL NICKEL <b>HD</b>
---------------	--------------------------	-----------------	------------------------	-----------------------

<b>Locks</b>	\$75 :Y
--------------	---------

Freight Class: 125

### Overhead Storage Unit, Aluminum/Frosted Doors

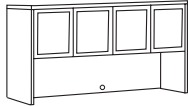

- Two storage compartments
- Four aluminum/frosted doors
- 21" monitor clearance under cabinet
- Grommet in back panel

<b>HW_737AD</b>	72" x 16" x 36.5" Cubic Ft: 33.6 Ship Weight: 220		<b>1904</b>	<b>1933</b>	<b>1961</b>
	<b>Task Light T</b>		\$124	\$126	\$128
	<b>LED Task Light L</b>		\$212	\$215	\$218

Freight Class: 125

### Overhead Storage Unit

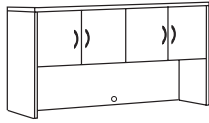

- Same features as above except:
- Four wood doors

<b>H_737 QS</b>	72" x 16" x 36.5" Cubic Ft: 33.6 Ship Weight: 221		<b>1199</b>	<b>1217</b>	<b>1235</b>
	<b>Task Light T</b>		\$124	\$126	\$128
	<b>LED Task Light L</b>		\$212	\$215	\$218
<b>H_677</b>	66" x 16" x 36.5" Cubic Ft: 28.3 Ship Weight: 198		<b>952</b>	<b>966</b>	<b>981</b>
	<b>Task Light T</b>		\$124	\$126	\$128
	<b>LED Task Light L</b>		\$212	\$215	\$218
<b>H_675</b>	60" x 16" x 36.5" Cubic Ft: 28.3 Ship Weight: 180		<b>939</b>	<b>953</b>	<b>967</b>
	<b>Task Light T</b>		\$124	\$126	\$128
	<b>LED Task Light L</b>		\$212	\$215	\$218
<b>H_537</b>	54" x 16" x 36.5" Cubic Ft: 28.3 Ship Weight: 170		<b>930</b>	<b>944</b>	<b>958</b>
	<b>Task Light T</b>		\$124	\$126	\$128
	<b>LED Task Light L</b>		\$212	\$215	\$218

<b>Pulls:</b>	BRUSHED CHROME <b>HW</b>	EBONY <b>HE</b>	BRIGHT BRASS <b>HB</b>	OVAL NICKEL <b>HD</b>
---------------	--------------------------	-----------------	------------------------	-----------------------

<b>QS FINISHES</b>	<b>WC</b>	<b>QS PULLS</b>	<b>W</b>
--------------------	-----------	-----------------	----------

<b>Locks</b>	\$150 :Y
--------------	----------

Freight Class: 125

### Overhead Storage Unit

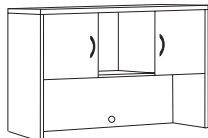

- Two compartments with doors
- Center open storage
- 21" monitor clearance under cabinet
- Grommet in back panel

<b>H_477</b>	48" x 16" x 36.5" Cubic Ft: 24.3 Ship Weight: 163		<b>761</b>	<b>772</b>	<b>784</b>
	<b>Task Light T</b>		\$124	\$126	\$128
	<b>LED Task Light L</b>		\$212	\$215	\$218

<b>Pulls:</b>	BRUSHED CHROME <b>HW</b>	EBONY <b>HE</b>	BRIGHT BRASS <b>HB</b>	OVAL NICKEL <b>HD</b>
---------------	--------------------------	-----------------	------------------------	-----------------------

<b>Locks</b>	\$150 :Y
--------------	----------

Freight Class: 125



# FINISH SELECTION

NATURAL MAPLE **FM** | WINDSOR CHERRY **WC** | MAHOGANY **M** | GRAPHITE **GP** | MEDIUM OAK **O** | ASPEN **AP** | PEARWOOD **PW** | BLACK **E** | ESPRESSO **X** | GREY **G** | CLASSIC CHERRY **CC** |

# SIN 711-2 HYPERWORK

## Overhead Storage Unit

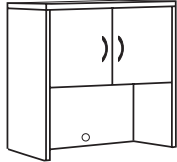

- Storage compartment
- Two doors
- 21" monitor clearance under cabinet
- Grommet in back panel

		Zone Pricing	1	2	3
<b>H_475</b>	42" x 16" x 36.5" Cubic Ft: 24.3 Ship Weight: 143		<b>689</b>	<b>699</b>	<b>710</b>
	<b>Task Light T</b>		\$124	\$126	\$128
	<b>LED Task Light L</b>		\$212	\$215	\$218
<b>H_337</b>	36" x 16" x 36.5" Cubic Ft: 15.3 Ship Weight: 125		<b>659</b>	<b>669</b>	<b>679</b>
	<b>Task Light T</b>		\$124	\$126	\$128
	<b>LED Task Light L</b>		\$212	\$215	\$218
<b>H_335</b>	30" x 16" x 36.5" Cubic Ft: 15.3 Ship Weight: 120		<b>607</b>	<b>616</b>	<b>625</b>
	<b>Task Light T</b>		\$124	\$126	\$128
	<b>LED Task Light L</b>		\$212	\$215	\$218

<b>Pulls:</b>	BRUSHED CHROME <b>HW</b>	EBONY <b>HE</b>	BRIGHT BRASS <b>HB</b>	OVAL NICKEL <b>HD</b>
	<b>Locks</b> \$75 :Y			

Freight Class: 125

## Open Overhead Storage Unit

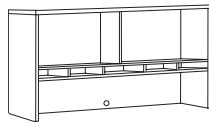

- Two cabinet compartments
- Five paper storage shelves
- 18-1/2" monitor clearance under cabinet
- Grommet in back panel

<b>HW_718</b>	72" x 16" x 36.5" Cubic Ft: 33.6 Ship Weight: 200		<b>1348</b>	<b>1368</b>	<b>1388</b>
	<b>Task Light T</b>		\$124	\$126	\$128
	<b>LED Task Light L</b>		\$212	\$215	\$218
<b>HW_618</b>	66" x 16" x 36.5" Cubic Ft: 28.3 Ship Weight: 178		<b>986</b>	<b>1001</b>	<b>1016</b>
	<b>Task Light T</b>		\$124	\$126	\$128
	<b>LED Task Light L</b>		\$212	\$215	\$218
<b>HW_616</b>	60" x 16" x 36.5" Cubic Ft: 28.3 Ship Weight: 160		<b>960</b>	<b>974</b>	<b>989</b>
	<b>Task Light T</b>		\$124	\$126	\$128
	<b>LED Task Light L</b>		\$212	\$215	\$218
<b>HW_518</b>	54" x 16" x 36.5" Cubic Ft: 26.2 Ship Weight: 160		<b>952</b>	<b>966</b>	<b>981</b>
	<b>Task Light T</b>		\$124	\$126	\$128
	<b>LED Task Light L</b>		\$212	\$215	\$218

Freight Class: 125

## Open Overhead Storage Unit

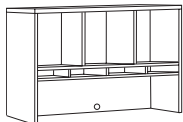

- Three cabinet compartments
- Four paper storage shelves
- 18-1/2" monitor clearance under cabinet
- Grommet in back panel

<b>HW_418</b>	48" x 16" x 36.5" Cubic Ft: 24.3 Ship Weight: 155		<b>822</b>	<b>834</b>	<b>847</b>
	<b>Task Light T</b>		\$124	\$126	\$128
	<b>LED Task Light L</b>		\$212	\$215	\$218

Freight Class: 125

## Open Overhead Storage Unit



- Storage compartment
- Three paper storage shelves
- 18-1/2" monitor clearance under cabinet
- Grommet in back panel

<b>HW_416</b>	42" x 16" x 36.5" Cubic Ft: 24.3 Ship Weight: 140		<b>751</b>	<b>762</b>	<b>774</b>
	<b>Task Light T</b>		\$124	\$126	\$128
	<b>LED Task Light L</b>		\$212	\$215	\$218
<b>HW_318</b>	36" x 16" x 36.5" Cubic Ft: 15.3 Ship Weight: 125		<b>738</b>	<b>749</b>	<b>760</b>
	<b>Task Light T</b>		\$124	\$126	\$128
	<b>LED Task Light L</b>		\$212	\$215	\$218
<b>HW_316</b>	30" x 16" x 36.5" Cubic Ft: 15.3 Ship Weight: 120		<b>724</b>	<b>735</b>	<b>746</b>
	<b>Task Light T</b>		\$124	\$126	\$128
	<b>LED Task Light L</b>		\$212	\$215	\$218

Freight Class: 125

## Open Overhead Storage Unit

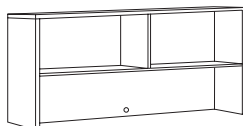

- Two cabinet compartments
- 21" monitor clearance under cabinet
- Grommet in back panel

<b>HW_717 QS</b>	72" x 16" x 36.5" Cubic Ft: 33.6 Ship Weight: 181		<b>1022</b>	<b>1037</b>	<b>1053</b>
	<b>Task Light T</b>		\$124	\$126	\$128
	<b>LED Task Light L</b>		\$212	\$215	\$218
<b>HW_617</b>	66" x 16" x 36.5" Cubic Ft: 28.3 Ship Weight: 158		<b>666</b>	<b>676</b>	<b>686</b>
	<b>Task Light T</b>		\$124	\$126	\$128
	<b>LED Task Light L</b>		\$212	\$215	\$218
<b>HW_615</b>	60" x 16" x 36.5" Cubic Ft: 28.3 Ship Weight: 140		<b>644</b>	<b>654</b>	<b>663</b>
	<b>Task Light T</b>		\$124	\$126	\$128
	<b>LED Task Light L</b>		\$212	\$215	\$218
<b>HW_517</b>	54" x 16" x 36.5" Cubic Ft: 26 Ship Weight: 138		<b>634</b>	<b>644</b>	<b>653</b>
	<b>Task Light T</b>		\$124	\$126	\$128
	<b>LED Task Light L</b>		\$212	\$215	\$218

Freight Class: 125

**QS FINISHES WC**

CONTEMPORARY LAMINATE



H W FM CH7272	
Pull	Finish

### Open Overhead Storage Unit

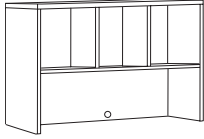

- Three cabinet compartments
- 21" monitor clearance under cabinet
- Grommet in back panel

Freight Class: 125

### Open Overhead Storage Unit

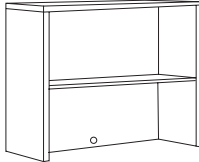

- Storage compartment
- 21" monitor clearance under cabinet
- Grommet in back panel

Freight Class: 125

### Overhead Bookcase Hutch



- Adjustable shelves
- Fits 36" Lateral File, MultiFile or Two Door Storage Cabinet

Freight Class: 125

### 72" Overhead Organizer

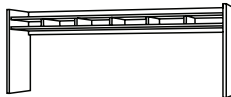

- 72" worksurface
- Six paper storage shelves
- Open back

Freight Class: 85

### Reception Organizer

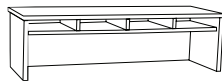

- Transaction countertop
- Four paper storage shelves

Freight Class: 70

### Corner Hutch with Doors

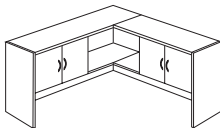

- 72" x 72" footprint
- Two compartments with doors
- Open center storage
- Components for corner hutches are 15" deep, standard overhead storage units are 16" deep
- 21" monitor clearance under cabinet
- If installed task light ordered, specify location
- Assembly required

Freight Class: 125

Zone Pricing

1

2

3

<b>HW_417</b>	48" x 16" x 36.5" Cubic Ft: 24.3	Ship Weight: 135	<b>582</b>	<b>591</b>	<b>599</b>
		<b>Task Light T</b>	\$124	\$126	\$128
		<b>LED Task Light L</b>	\$212	\$215	\$218

<b>HW_415</b>	42" x 16" x 36.5" Cubic Ft: 24.3	Ship Weight: 123	<b>514</b>	<b>522</b>	<b>529</b>
		<b>Task Light T</b>	\$124	\$126	\$128
		<b>LED Task Light L</b>	\$212	\$215	\$218

<b>HW_317</b>	36" x 16" x 36.5" Cubic Ft: 15.3	Ship Weight: 123	<b>499</b>	<b>506</b>	<b>514</b>
		<b>Task Light T</b>	\$124	\$126	\$128
		<b>LED Task Light L</b>	\$212	\$215	\$218

<b>HW_315</b>	30" x 16" x 36.5" Cubic Ft: 15.3	Ship Weight: 100	<b>484</b>	<b>491</b>	<b>499</b>
		<b>Task Light T</b>	\$124	\$126	\$128
		<b>LED Task Light L</b>	\$212	\$215	\$218

<b>HW_319</b>	36" x 16" x 36.5" Cubic Ft: 15.3	Ship Weight: 115	<b>698</b>	<b>708</b>	<b>719</b>
---------------	----------------------------------	------------------	------------	------------	------------

<b>HW_7227</b>	72" x 16" x 36.5" Cubic Ft: 23	Ship Weight: 85	<b>784</b>	<b>796</b>	<b>808</b>
----------------	--------------------------------	-----------------	------------	------------	------------

**Discontinued March 1, 2012**

<b>HW_4818</b>	48" x 18" x 14" Cubic Ft: 12	Ship Weight: 50	<b>725</b>	<b>736</b>	<b>747</b>
----------------	------------------------------	-----------------	------------	------------	------------

<b>H_CH7272</b>	72" x 72" x 36.5" Cubic Ft: 61.9	Ship Weight: 316	<b>2321</b>	<b>2356</b>	<b>2391</b>
		<b>Task Light T</b>	\$124	\$126	\$128
		<b>LED Task Light L</b>	\$212	\$215	\$218

<b>Pulls:</b>	BRUSHED CHROME <b>HW</b>	EBONY <b>HE</b>	BRIGHT BRASS <b>HB</b>	OVAL NICKEL <b>HD</b>
---------------	--------------------------	-----------------	------------------------	-----------------------

Consists of H\_872L & H\_857R

# FINISH SELECTION

NATURAL MAPLE **FM** | WINDSOR CHERRY **WC** | MAHOGANY **M** | GRAPHITE **GP** | MEDIUM OAK **O** | ASPEN **AP** | PEARWOOD **PW** | BLACK **E** | ESPRESSO **X** | GREY **G** | CLASSIC CHERRY **CC** |

# SIN 711-2 HYPERWORK

## Left Corner Hutch with Doors

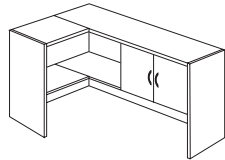

- 72" or 66" with 36" left return
- Right compartment with doors
- Open center/return storage
- Components for corner hutches are 15" deep, standard overhead storage units are 16" deep
- If installed task light ordered, specify location
- Assembly required

Freight Class: 125

## Right Corner Hutch with Doors

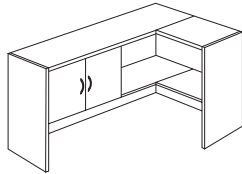

- Same description as above except:
- 72" or 66" with 36" right return
- Left compartment with doors

Freight Class: 125

## Open Corner Hutch with Doors

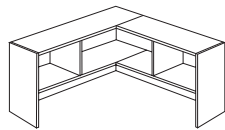

- 72" x 72" footprint
- Open storage
- Components for corner hutches are 15" deep, standard overhead storage units are 16" deep
- 21" monitor clearance under cabinet
- If installed task light ordered, specify location
- Assembly required

Freight Class: 125

## Open Corner Hutch

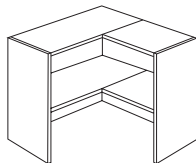

- 42" or 36" footprint
- Open storage
- Components for corner hutches are 15" deep, standard overhead storage units are 16" deep
- 21" monitor clearance under cabinet
- If installed task light ordered, specify location
- Assembly required

Freight Class: 125

## Left Open Corner Hutch

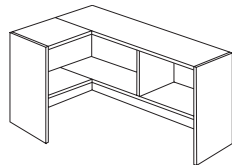

- 72" or 66" with 36" left return
- Open storage
- Components for corner hutches are 15" deep, standard overhead storage units are 16" deep
- 21" monitor clearance under cabinet
- If installed task light ordered, specify location

Freight Class: 125

## Left Open Corner Hutch

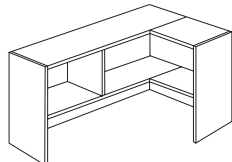

- Same description as above except:
- 72" or 66" with 36" right return

Freight Class: 125

Zone Pricing

1

2

3

<b>H__CH7236L</b> 72" x 36" x 36.5" Cubic Ft: 45.2 Ship Weight: 253	<b>1635</b>	<b>1660</b>	<b>1684</b>
<b>Task Light T</b>	\$124	\$126	\$128
<b>LED Task Light L</b>	\$212	\$215	\$218
<b>H__CH6636L</b> 66" x 36" x 36.5" Cubic Ft: 39.9 Ship Weight: 223	<b>1422</b>	<b>1443</b>	<b>1465</b>
<b>Task Light T</b>	\$124	\$126	\$128
<b>LED Task Light L</b>	\$212	\$215	\$218

<b>Pulls:</b>	BRUSHED CHROME <b>HW</b>	EBONY <b>HE</b>	BRIGHT BRASS <b>HB</b>	OVAL NICKEL <b>HD</b>
---------------	--------------------------	-----------------	------------------------	-----------------------

H\_\_CH7236L consists of H\_872R & H\_822L  
H\_\_CH6636L consists of H\_866R & H\_822L

<b>H__CH7236R</b> 72" x 36" x 36.5" Cubic Ft: 45.2 Ship Weight: 253	<b>1635</b>	<b>1660</b>	<b>1684</b>
<b>Task Light T</b>	\$124	\$126	\$128
<b>LED Task Light L</b>	\$212	\$215	\$218
<b>H__CH6636R</b> 66" x 36" x 36.5" Cubic Ft: 39.9 Ship Weight: 223	<b>1422</b>	<b>1443</b>	<b>1465</b>
<b>Task Light T</b>	\$124	\$126	\$128
<b>LED Task Light L</b>	\$212	\$215	\$218

<b>Pulls:</b>	BRUSHED CHROME <b>HW</b>	EBONY <b>HE</b>	BRIGHT BRASS <b>HB</b>	OVAL NICKEL <b>HD</b>
---------------	--------------------------	-----------------	------------------------	-----------------------

H\_\_CH7236R consists of H\_872L & H\_822R  
H\_\_CH6636R consists of H\_866L & H\_822R

<b>HW_CHO7272</b> 72" x 72" x 36.5" Cubic Ft: 45.2 Ship Weight: 233	<b>2022</b>	<b>2052</b>	<b>2083</b>
<b>Task Light T</b>	\$124	\$126	\$128
<b>LED Task Light L</b>	\$212	\$215	\$218

Consists of H\_870L & H\_850R

<b>HW_CHO4242</b> 42" x 42" x 36.5" Cubic Ft: 35.9 Ship Weight: 180	<b>919</b>	<b>933</b>	<b>947</b>
<b>HW_CHO3636</b> 36" x 36" x 36.5" Cubic Ft: 26.8 Ship Weight: 165	<b>858</b>	<b>871</b>	<b>884</b>
<b>Task Light T</b>	\$124	\$126	\$128
<b>LED Task Light L</b>	\$212	\$215	\$218

H\_\_CHO4242 consists of H\_840L & H\_828R,  
H\_\_CHO3636 consists of H\_830L & H\_822R

<b>HW_CHO7236L</b> 42" x 36" x 36.5" Cubic Ft: 45.2 Ship Weight: 233	<b>1304</b>	<b>1324</b>	<b>1343</b>
<b>HW_CHO6636L</b> 72" x 36" x 36.5" Cubic Ft: 39.9 Ship Weight: 203	<b>1140</b>	<b>1157</b>	<b>1174</b>
<b>Task Light T</b>	\$124	\$126	\$128
<b>LED Task Light L</b>	\$212	\$215	\$218

H\_\_CHO7236L consists of H\_860R & H\_822L,  
H\_\_CHO6636L consists of H\_860R & H\_822L

<b>HW_CHO 7236R</b> 72" x 36" x 36.5" Cubic Ft: 45.2 Ship Weight: 233	<b>1304</b>	<b>1324</b>	<b>1343</b>
<b>HW_CHO6636R</b> 66" x 36" x 36.5" Cubic Ft: 39.9 Ship Weight: 203	<b>1140</b>	<b>1157</b>	<b>1174</b>
<b>Task Light T</b>	\$124	\$126	\$128
<b>LED Task Light L</b>	\$212	\$215	\$218

H\_\_CHO7236R consists of H\_860L & H\_822R,  
H\_\_CHO6636R consists of H\_860L & H\_822R

CONTEMPORARY LAMINATE

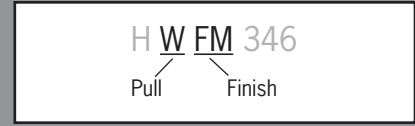

## Storage, Filing & Bookcases

Zone Pricing	1	2	3
--------------	---	---	---

### Two-Drawer Lateral File



- Two lateral file drawers, legal or letter filing
- Single-key, front-locking
- Pre-installed black filing hardware
- Anti-tilt counterweight standard
- Hardwood bottom support rail secured with metal bracket on each end

Freight Class: 100

<b>H_346</b>	<b>QS</b>	36.5" x 24" x 29"	Cubic Ft: 19.8	Ship Weight: 185	<b>983</b>	<b>998</b>	<b>1012</b>
<b>H_326</b>		30.75" x 20" x 29"	Cubic Ft: 14	Ship Weight: 140	<b>921</b>	<b>935</b>	<b>949</b>

<b>Pulls:</b>	BRUSHED CHROME <b>HW</b>	EBONY <b>HE</b>	BRIGHT BRASS <b>HB</b>	OVAL NICKEL <b>HD</b>
---------------	--------------------------	-----------------	------------------------	-----------------------

<b>QS FINISHES</b>	<b>WC</b>	<b>QS PULLS</b>	<b>W</b>
--------------------	-----------	-----------------	----------

<b>EXTRA THICK BOTTOM</b>	\$160 <b>H</b>
---------------------------	----------------

### Three-Drawer Lateral File

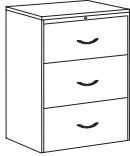

- Three lateral file drawers, legal or letter filing
- Pre-installed black filing hardware
- Central locking (lock on front)
- Anti-tilt mechanism prevents more than one drawer opening at one time
- Hardwood bottom support rail secured with metal bracket on each end

Freight Class: 100

<b>H_3036</b>	<b>QS</b>	30.75" x 20.75" x 44.5"	Cubic Ft: 27.9	Ship Weight: 205	<b>1821</b>	<b>1848</b>	<b>1876</b>
---------------	-----------	-------------------------	----------------	------------------	-------------	-------------	-------------

<b>Pulls:</b>	BRUSHED CHROME <b>HW</b>	EBONY <b>HE</b>	BRIGHT BRASS <b>HB</b>	OVAL NICKEL <b>HD</b>
---------------	--------------------------	-----------------	------------------------	-----------------------

<b>QS FINISHES</b>	<b>WC</b>	<b>QS PULLS</b>	<b>W</b>
--------------------	-----------	-----------------	----------

<b>EXTRA THICK BOTTOM</b>	\$240 <b>H</b>
---------------------------	----------------

### Four-Drawer Lateral File

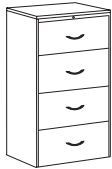

- Four lateral file drawers, legal or letter filing
- Pre-installed black filing hardware
- Central locking (lock on front)
- Anti-tilt mechanism prevents more than one drawer opening at one time
- Hardwood bottom support rail secured with metal bracket on each end

Freight Class: 100

<b>H_426</b>	<b>QS</b>	30.75" x 20.75" x 56.75"	Cubic Ft: 27.9	Ship Weight: 252	<b>2090</b>	<b>2121</b>	<b>2153</b>
--------------	-----------	--------------------------	----------------	------------------	-------------	-------------	-------------

<b>Pulls:</b>	BRUSHED CHROME <b>HW</b>	EBONY <b>HE</b>	BRIGHT BRASS <b>HB</b>	OVAL NICKEL <b>HD</b>
---------------	--------------------------	-----------------	------------------------	-----------------------

<b>QS FINISHES</b>	<b>WC</b>	<b>QS PULLS</b>	<b>W</b>
--------------------	-----------	-----------------	----------

<b>EXTRA THICK BOTTOM</b>	\$320 <b>H</b>
---------------------------	----------------

### Mobile Box/Box/File Pedestal



- Fits under work surfaces
- Pre-installed, black filing hardware
- Legal or letter filing
- Single-key front locking
- Four casters, two locking

Freight Class: 100

<b>H_212BF</b>		16" x 22.25" x 27.25"	Cubic Ft: 10.3	Ship Weight: 105	<b>856</b>	<b>869</b>	<b>882</b>
----------------	--	-----------------------	----------------	------------------	------------	------------	------------

<b>Pulls:</b>	BRUSHED CHROME <b>HW</b>	EBONY <b>HE</b>	BRIGHT BRASS <b>HB</b>	OVAL NICKEL <b>HD</b>
---------------	--------------------------	-----------------	------------------------	-----------------------

### Mobile File/File Pedestal



- Fits under work surfaces
- Pre-installed, black filing hardware
- Legal or letter filing
- Single-key front locking
- Four casters, two locking

Freight Class: 100

<b>H_21F</b>		16" x 22.25" x 27.25"	Cubic Ft: 9.9	Ship Weight: 93	<b>856</b>	<b>869</b>	<b>882</b>
--------------	--	-----------------------	---------------	-----------------	------------	------------	------------

<b>Pulls:</b>	BRUSHED CHROME <b>HW</b>	EBONY <b>HE</b>	BRIGHT BRASS <b>HB</b>	OVAL NICKEL <b>HD</b>
---------------	--------------------------	-----------------	------------------------	-----------------------

### Mobile Box/File Pedestal

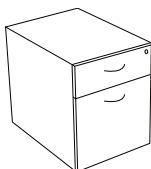

- Fits under work surfaces
- Pre-installed, black filing hardware
- Legal or letter filing
- Single-key front locking
- Four casters, two locking

Freight Class: 100

<b>H_20</b>		16" x 22.25" x 23.5"	Cubic Ft: 7	Ship Weight: 85	<b>780</b>	<b>792</b>	<b>803</b>
-------------	--	----------------------	-------------	-----------------	------------	------------	------------

<b>Pulls:</b>	BRUSHED CHROME <b>HW</b>	EBONY <b>HE</b>	BRIGHT BRASS <b>HB</b>	OVAL NICKEL <b>HD</b>
---------------	--------------------------	-----------------	------------------------	-----------------------

## FINISH SELECTION

NATURAL MAPLE **FM** | WINDSOR CHERRY **WC** | MAHOGANY **M** | GRAPHITE **GP** | MEDIUM OAK **O** | ASPEN **AP** | PEARWOOD **PW** | BLACK **E** | ESPRESSO **X** | GREY **G** | CLASSIC CHERRY **CC** |

# SIN 711-2 HYPERWORK

### Two-Drawer Legal File

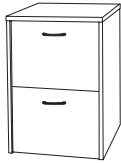

- Legal filing front-to-back
- Two legal size file drawers
- Pre-installed, black filing hardware

Freight Class: 100

		Zone Pricing		
		1	2	3
<b>H_2DLF</b>	19" x 24" x 29" Cubic Ft: 12.2 Ship Weight: 111	<b>971</b>	<b>986</b>	<b>1000</b>

<b>Pulls:</b>	BRUSHED CHROME <b>HW</b>	EBONY <b>HE</b>	BRIGHT BRASS <b>HB</b>	OVAL NICKEL <b>HD</b>
---------------	--------------------------	-----------------	------------------------	-----------------------

### Mobile-Under Surface Storage/File

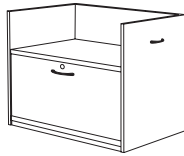

- Fits under work surfaces
- Lateral file drawer
- Pre-installed, black filing hardware
- Legal or letter filing
- Single-key front locking
- Optional seat cushion

Freight Class: 100

<b>H_26</b>	30.5" x 20.5" x 26" Cubic Ft: 13.9 Ship Weight: 116	<b>1061</b>	<b>1077</b>	<b>1093</b>
-------------	---	-------------	-------------	-------------

<b>Pulls:</b>	BRUSHED CHROME <b>HW</b>	EBONY <b>HE</b>	BRIGHT BRASS <b>HB</b>	OVAL NICKEL <b>HD</b>
---------------	--------------------------	-----------------	------------------------	-----------------------

<b>EXTRA THICK BOTTOM</b>	\$80 <b>H</b>
---------------------------	---------------

### Mobile Under Surface Storage/Cabinet

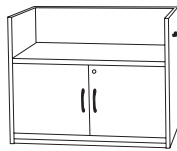

- Fits under work surfaces
- Storage cabinet with doors
- Single-key locking
- Optional seat cushion

Freight Class: 100

<b>H_26D</b>	30.5" x 20.5" x 26" Cubic Ft: 13.9 Ship Weight: 101	<b>921</b>	<b>935</b>	<b>949</b>
--------------	---	------------	------------	------------

<b>Pulls:</b>	BRUSHED CHROME <b>HW</b>	EBONY <b>HE</b>	BRIGHT BRASS <b>HB</b>	OVAL NICKEL <b>HD</b>
---------------	--------------------------	-----------------	------------------------	-----------------------

### Multi-File

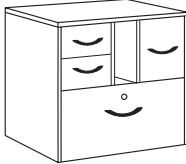

- One lateral file drawer with lock
- One file drawer
- Two box drawers
- Hot projects access slot
- Pre-installed black filing hardware
- Legal or letter filing

Freight Class: 100

<b>H_735</b>	36.5" x 24" x 29" Cubic Ft: 19.8 Ship Weight: 196	<b>1163</b>	<b>1180</b>	<b>1198</b>
--------------	---	-------------	-------------	-------------

<b>Pulls:</b>	BRUSHED CHROME <b>HW</b>	EBONY <b>HE</b>	BRIGHT BRASS <b>HB</b>	OVAL NICKEL <b>HD</b>
---------------	--------------------------	-----------------	------------------------	-----------------------

<b>EXTRA THICK BOTTOM</b>	\$80 <b>H</b>
---------------------------	---------------

### Seat Cushion

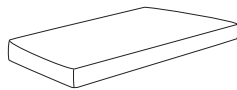

- Fits H\_26 and H\_26D under surface storage cabinets
- Available in any upholstery
- QUICK SHIP in QS fabric

28.5" X 19" X 2"

Freight Class: 100

**H26 28.5" X 19" X 2"**

Grade	1	2	3	4	5	6	7	8	9	10
<b>Zone 1</b>	269	296	337	356	371	404	416	469	501	542
<b>Zone 2</b>	273	300	342	361	377	410	422	476	509	550
<b>Zone 3</b>	277	305	347	367	382	416	428	483	516	558

Cubic Ft: 2.0

Ship Weight: 3.0

### Mobile Box/File Pedestal with Upholstered Top

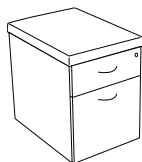

Freight Class: 100

Cubic Ft: 7

Ship Weight: 87

**H\_20S 16" X 22.25" X 23.5"**

Grade	1	2	3	4	5	6	7	8	9	10	L	LL
<b>Zone 1</b>	973	988	1006	1020	1035	1055	1074	1094	1114	1139	1193	1297
<b>Zone 2</b>	988	1003	1021	1035	1050	1071	1090	1110	1131	1156	1211	1316
<b>Zone 3</b>	1002	1018	1036	1051	1066	1087	1106	1127	1147	1173	1229	1336

- Pre-installed black filing hardware
- Letter or legal filing
- Front locking
- Upholstered seat on top
- Four casters, two locking

CONTEMPORARY LAMINATE



H W FM 735	
Pull	Finish

Zone Pricing	1	2	3
--------------	---	---	---

### Bookcase

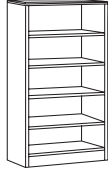

- 84" = 5 adjustable shelves
- 72" = 4 adjustable shelves
- 60" = 3 adjustable shelves
- Bottom shelf fixed
- All shelves 1" thick
- AdvantEdge front edge
- Back panel finished on one side

Freight Class: 125

<b>HW_60</b>	36" x 12" x 60"	Cubic Ft: 21	Ship Weight: 121	<b>821</b>	<b>833</b>	<b>846</b>
<b>HW_72</b>	36" x 12" x 72"	Cubic Ft: 24.7	Ship Weight: 149	<b>932</b>	<b>946</b>	<b>960</b>
<b>HW_84</b>	36" x 12" x 84"	Cubic Ft: 29	Ship Weight: 178	<b>997</b>	<b>1012</b>	<b>1027</b>

### Bookcase



- HW\_48 same as above except 2 adjustable shelves (shown)
- HW\_36 same as above except 1 adjustable shelf

Freight Class: 125

<b>HW_36</b>	36" x 12" x 36"	Cubic Ft: 13	Ship Weight: 121	<b>563</b>	<b>571</b>	<b>580</b>
<b>HW_48</b>	36" x 12" x 48"	Cubic Ft: 16.8	Ship Weight: 149	<b>596</b>	<b>605</b>	<b>614</b>

### Five Shelf Bookcase

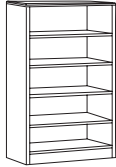

- Three adjustable shelves
- Bottom and second-from-bottom shelves fixed
- All shelves 1" thick
- AdvantEdge front edge
- Back panel 3/4" thick, finished on both sides

Freight Class: 125

<b>HW_65 QS</b>	36" x 16" x 65.5"	Cubic Ft: 31.8	Ship Weight: 205	<b>865</b>	<b>878</b>	<b>891</b>
-----------------	-------------------	----------------	------------------	------------	------------	------------

**QS FINISHES WC**

### Bookcase with Doors

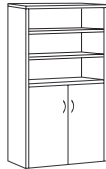

- All shelves 1" thick
- AdvantEdge front edge
- Back panel 3/4" thick, finished both sides
- Two adjustable and one fixed shelves in top
- One adjustable shelf behind doors in bottom

Freight Class: 125

<b>HW_652D</b>	36" x 16" x 65.5"	Cubic Ft: 31.8	Ship Weight: 222	<b>1125</b>	<b>1142</b>	<b>1159</b>
----------------	-------------------	----------------	------------------	-------------	-------------	-------------

<b>Pulls:</b>	BRUSHED CHROME <b>HW</b>	EBONY <b>HE</b>	BRIGHT BRASS <b>HB</b>	OVAL NICKEL <b>HD</b>
---------------	--------------------------	-----------------	------------------------	-----------------------

### Curved Corner Bookcase - 65.5" High

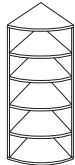

- Fits in corner at end of workstation
- Five shelf storage
- Four adjustable shelves
- Bottom shelf fixed
- All shelves 1" thick
- AdvantEdge front edge

Freight Class: 125

<b>HW_CB65</b>	24" x 24" x 65.5"	Cubic Ft: 31.6	Ship Weight: 182	<b>927</b>	<b>941</b>	<b>955</b>
----------------	-------------------	----------------	------------------	------------	------------	------------

### Curved Corner Bookcase - 65.5" High

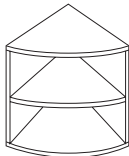

- Two sizes
- Fits in corner at end of work surface
- Middle shelf adjustable
- All shelves 1" thick
- AdvantEdge front edge

Freight Class: 125

<b>HW_CB29</b>	24" x 24" x 29"	Cubic Ft: 19.4	Ship Weight: 115	<b>596</b>	<b>605</b>	<b>614</b>
<b>HW_CB2930</b>	30" x 30" x 29"	Cubic Ft: 19.4	Ship Weight: 140	<b>714</b>	<b>725</b>	<b>735</b>



## FINISH SELECTION

NATURAL MAPLE **FM** | WINDSOR CHERRY **WC** | MAHOGANY **M** |  
 GRAPHITE **GP** | MEDIUM OAK **O** | ASPEN **AP** | PEARWOOD **PW** |  
 BLACK **E** | ESPRESSO **X** | GREY **G** | CLASSIC CHERRY **CC** |

# SIN 711-2 HYPERWORK

### Compact Organizer

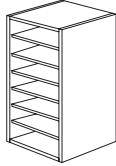

- Rests on credenza, return, etc.
- Fits beneath overheads without paper storage
- Five pullout paper shelves
- One pullout accessory tray with tape dispenser

Freight Class: 100

		Zone Pricing		
		1	2	3
<b>HW_CO</b>	11" x 13" x 20" Cubic Ft: 2.1 Ship Weight: 40	<b>329</b>	<b>334</b>	<b>339</b>

## Storage & Conference Accessories

### Mobile Audio/Visual Cabinet



- Full-opening doors
- Upper/lower locks
- Up to 29", 150-lb. TV
- Pullout 360-degree swivel TV shelf
- Adjustable VCR shelf at top
- Two adjustable shelves in bottom
- Shelf and back grommets
- 400 lb. Capacity
- Handhold and casters for easy movement

Freight Class: 125

<b>H_65AV</b>	36.5" x 24" x 65.5" Cubic Ft: 43.1 Ship Weight: 326	<b>2490</b>	<b>2527</b>	<b>2565</b>
---------------	---	-------------	-------------	-------------

### Mobile Media Stand

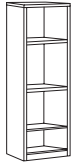

- Three adjustable shelves
- Cords drop behind shelves
- Grommets in back for wire management
- Handhold and casters for easy movement

Freight Class: 125

<b>HW_MMS</b>	24" x 24" x 65.5" Cubic Ft: 31.6 Ship Weight: 192	<b>1237</b>	<b>1256</b>	<b>1274</b>
---------------	---	-------------	-------------	-------------

### Storage Cabinet



- Storage compartment 34" x 19.5/8" x 34"
- Two adjustable shelves in storage compartment
- Two lateral file drawers, legal or letter filing
- Single-key, front-locking file cabinet
- Hardwood bottom support rail secured with metal bracket on each end

Freight Class: 125

<b>H_65STOR QS</b>	36.5" x 24" x 65.5" Cubic Ft: 40.3 Ship Weight: 300	<b>1668</b>	<b>1693</b>	<b>1718</b>
--------------------	---	-------------	-------------	-------------

**Pulls:** BRUSHED CHROME **HW** | EBONY **HE** | BRIGHT BRASS **HB** | OVAL NICKEL **HD**

**QS FINISHES** **WC**

**QS PULLS** **W**

**EXTRA THICK BOTTOM** \$160 **H**

### Wardrobe

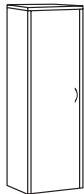

- Coat rod mounted side-to-side
- Adjustable shelf near bottom
- H\_65WDL - Door hinge on left
- H\_65WDR - Door hinge on right
- Shown with left hinge

Freight Class: 125

<b>H_65WDL</b>	24" x 24" x 65.5" Cubic Ft: 31.6 Ship Weight: 130	<b>1177</b>	<b>1195</b>	<b>1212</b>
----------------	---	-------------	-------------	-------------

<b>H_65WDR</b>	24" x 24" x 65.5" Cubic Ft: 31.6 Ship Weight: 130	<b>1177</b>	<b>1195</b>	<b>1212</b>
----------------	---	-------------	-------------	-------------

**Pulls:** BRUSHED CHROME **HW** | EBONY **HE** | BRIGHT BRASS **HB** | OVAL NICKEL **HD**

CONTEMPORARY LAMINATE



Zone Pricing	1	2	3
--------------	---	---	---

### Left 3-In-1 Storage

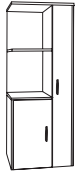

- Coat rod in wardrobe side on right
- One adjustable and one fixed shelf in top left
- Storage bottom left with one adjustable shelf

Freight Class: 125

<b>H__65TL</b>	24" x 24" x 65.5"	Cubic Ft: 31.6	Ship Weight: 208	<b>1469</b>	<b>1491</b>	<b>1513</b>
----------------	-------------------	----------------	------------------	-------------	-------------	-------------

<b>Pulls:</b>	BRUSHED CHROME <b>HW</b>	EBONY <b>HE</b>	BRIGHT BRASS <b>HB</b>	OVAL NICKEL <b>HD</b>
---------------	--------------------------	-----------------	------------------------	-----------------------

### Right 3-In-1 Storage

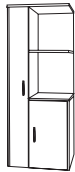

- Coat rod in top wardrobe left side
- One adjustable and one fixed shelf in right top
- Storage bottom right with one adjustable shelf

Freight Class: 125

<b>H__65TR</b>	24" x 24" x 65.5"	Cubic Ft: 31.6	Ship Weight: 208	<b>1469</b>	<b>1491</b>	<b>1513</b>
----------------	-------------------	----------------	------------------	-------------	-------------	-------------

<b>Pulls:</b>	BRUSHED CHROME <b>HW</b>	EBONY <b>HE</b>	BRIGHT BRASS <b>HB</b>	OVAL NICKEL <b>HD</b>
---------------	--------------------------	-----------------	------------------------	-----------------------

### Personal Tower, Right

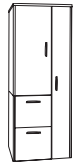

- Coat rod in wardrobe on right
- Storage cabinet with door above drawers with one adjustable shelf
- H\_\_65PTR - Two file drawers (shown)
- H\_\_65PTR2BR - Two box and one file drawer

Freight Class: 125

<b>H__65PTR</b>	24" x 24" x 65.5"	Cubic Ft: 31.6	Ship Weight: 255	<b>1811</b>	<b>1838</b>	<b>1865</b>
-----------------	-------------------	----------------	------------------	-------------	-------------	-------------

<b>H__65PTR2BF</b>	24" x 24" x 65.5"	Cubic Ft: 31.6	Ship Weight: 255	<b>1916</b>	<b>1945</b>	<b>1973</b>
--------------------	-------------------	----------------	------------------	-------------	-------------	-------------

<b>Pulls:</b>	BRUSHED CHROME <b>HW</b>	EBONY <b>HE</b>	BRIGHT BRASS <b>HB</b>	OVAL NICKEL <b>HD</b>
---------------	--------------------------	-----------------	------------------------	-----------------------

### Personal Tower, Left

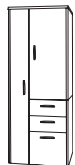

- Coat rod in wardrobe on left
- Storage cabinet with door above drawers with one adjustable shelf
- H\_\_65PTR - Two file drawers
- H\_\_65PTR2BR - Two box and one file drawer (shown)

Freight Class: 125

<b>H__65PTL</b>	24" x 24" x 65.5"	Cubic Ft: 31.6	Ship Weight: 255	<b>1811</b>	<b>1838</b>	<b>1865</b>
-----------------	-------------------	----------------	------------------	-------------	-------------	-------------

<b>H__65PTR2BF</b>	24" x 24" x 65.5"	Cubic Ft: 31.6	Ship Weight: 255	<b>1916</b>	<b>1945</b>	<b>1973</b>
--------------------	-------------------	----------------	------------------	-------------	-------------	-------------

<b>Pulls:</b>	BRUSHED CHROME <b>HW</b>	EBONY <b>HE</b>	BRIGHT BRASS <b>HB</b>	OVAL NICKEL <b>HD</b>
---------------	--------------------------	-----------------	------------------------	-----------------------

### MultiUse Wardrobe/Storage

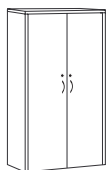

- Two-door storage area
- Coat rod mounted side-to-side on left
- Four adjustable shelves right
- Both sides drilled for adjustable shelves
- 3/4" thick shelves
- Individually locking doors

Freight Class: 125

<b>H__65DWD</b>	36.5" x 24" x 65.5"	Cubic Ft: 40.3	Ship Weight: 350	<b>1993</b>	<b>2023</b>	<b>2053</b>
-----------------	---------------------	----------------	------------------	-------------	-------------	-------------

<b>Pulls:</b>	BRUSHED CHROME <b>HW</b>	EBONY <b>HE</b>	BRIGHT BRASS <b>HB</b>	OVAL NICKEL <b>HD</b>
---------------	--------------------------	-----------------	------------------------	-----------------------

### Two-Door Storage Cabinet

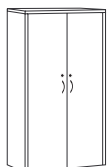

- Two-door storage cabinet
- Four full width adjustable shelves
- 1" thick shelves

Freight Class: 125

<b>H__65DS</b>	36.5" x 24" x 65.5"	Cubic Ft: 40.3	Ship Weight: 300	<b>1889</b>	<b>1917</b>	<b>1946</b>
----------------	---------------------	----------------	------------------	-------------	-------------	-------------

<b>Pulls:</b>	BRUSHED CHROME <b>HW</b>	EBONY <b>HE</b>	BRIGHT BRASS <b>HB</b>	OVAL NICKEL <b>HD</b>
---------------	--------------------------	-----------------	------------------------	-----------------------

## FINISH SELECTION

NATURAL MAPLE **FM** | WINDSOR CHERRY **WC** | MAHOGANY **M** |  
 GRAPHITE **GP** | MEDIUM OAK **O** | ASPEN **AP** | PEARWOOD **PW** |  
 BLACK **E** | ESPRESSO **X** | GREY **G** | CLASSIC CHERRY **CC** |

# SIN 711-2 HYPERWORK

Zone  
Pricing

1

2

3

### Two-Door Storage Unit

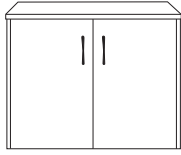

- Two hinged doors
- One adjustable shelf in storage area
- Leveling glides
- Inside dimension 34" x 21" x 25"

Freight Class: 100

**H\_732** 36.5" x 24" x 29" Cubic Ft: 19.2 Ship Weight: 133 **891** **904** **918**

**Pulls:** BRUSHED CHROME **HW** EBONY **HE** BRIGHT BRASS **HB** OVAL NICKEL **HD**

### Mobile Server Credenza



Freight Class: 125

- Flip-open tops with concealed hinges extends top surface to 72" wide
- Inside top/right drawer dimensions: 20" x 18" x 13" (Holds 2-liter bottles upright)
- Bottom/right drawer dimensions: 20" x 18" x 8"
- Door compartment on left includes nine holes for ventilation of small refrigerator, (inside dimensions 22" x 21" x 24")
- Casters for mobility

**H\_2248** 48" x 24" x 29" Cubic Ft: 25.3 Ship Weight: 228 **1498** **1520** **1543**

**Pulls:** BRUSHED CHROME **HW** EBONY **HE** BRIGHT BRASS **HB** OVAL NICKEL **HD**

### Mobile Server Cart



Freight Class: 100

- Flip-open top
- Top drawer 20" x 18" x 13" H. (Holds 2-liter soda bottles upright)
- Bottom drawer 20" x 18" x 8" H
- Casters for mobility
- 3/8" thick drawer bottoms

**H\_2224** 24.25" x 24.5" x 29" Cubic Ft: 16.7 Ship Weight: 150 **1321** **1341** **1361**

**Pulls:** BRUSHED CHROME **HW** EBONY **HE** BRIGHT BRASS **HB** OVAL NICKEL **HD**

### Mobile Teaming Board

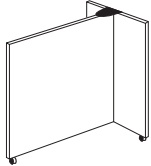

Freight Class: 100

- Dry-Erase whiteboard both sides
- Includes markers, eraser and mountable holder
- Tackboard available below
- Assembly required
- Casters for mobility

**HW\_MTB** 49" x 24" x 72" Cubic Ft: 13.2 Ship Weight: 178 **1047** **1063** **1078**

### Tackboard for Mobile Teaming Board

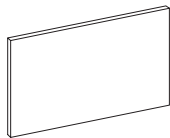

Freight Class: 100

- Fully tackable surface
- Core 952 Macro fabric
- Mounts to Mobile Teaming Board

**HW\_MBTB** 47.5" x 35.5" Cubic Ft: 3.1 Ship Weight: 20 **456** **463** **470**

### Marker Board

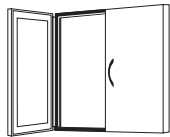

Freight Class: 100

- Marker board 45" x 42" inside
- Eraser and marker kit included
- Reverse-side of doors feature grey fabric-covered tackable surface
- Magnetic door catches
- Optional pre-installed projection screen; add P to model number-see below for pricing
- Grey finish features black case/frame

**H\_MB** 48" x 4.5" x 48" Cubic Ft: 12.2 Ship Weight: 141 **1124** **1141** **1158**

**Pulls:** BRUSHED CHROME **HW** EBONY **HE** BRIGHT BRASS **HB** OVAL NICKEL **HD**

### Projection Screen

- Roll down projection screen fits inside Marker Board
- Requires removal of fascia board for installation
- Must be factory-installed

Freight Class: 100

**PROJECTSCREEN** 40" x 48" Cubic Ft: 1.21 Ship Weight: 5 **137** **139** **141**

CONTEMPORARY LAMINATE



Zone Pricing	1	2	3
--------------	---	---	---

### Standing Lectern



- Pencil catch on angled surface is painted black on solid colors
- 2 storage shelves for presentation materials
- 4 casters included for field installation, 2 locking

Freight Class: 125

<b>HW_LS46C</b>	24" x 15" x 46"	Cubic Ft: 13.8	Ship Weight: 83	<b>700</b>	<b>710</b>	<b>721</b>
-----------------	-----------------	----------------	-----------------	------------	------------	------------

### Adjustable Height Computer Table



- Top height adjusts from 29" sitting position to 46" standing position
- Manual crank stores under top when not in use
- Four casters, two locking
- Ships in two cartons
- Assembly required

Freight Class: 85

<b>HW_2630AT</b>	30" x 26" x 29"	Cubic Ft: 9.8	Ship Weight: 78	<b>1692</b>	<b>1717</b>	<b>1743</b>
------------------	-----------------	---------------	-----------------	-------------	-------------	-------------

### Mobile Height-Adjustable Pie Shape Table



- Pie-shape top
- 10" pneumatic height adjustment for sitting or standing work area
- Five-star base with locking casters
- Freestanding

Freight Class: 125

<b>HW_ET24</b>	24" x 28" x 23-33"	Cubic Ft: 16.7	Ship Weight: 41	<b>824</b>	<b>836</b>	<b>849</b>
<b>HW_ET30</b>	30" x 35" x 23-33"	Cubic Ft: 16.7	Ship Weight: 51	<b>873</b>	<b>886</b>	<b>899</b>

### Mobile Height-Adjustable Bullet Shape Table



- Bullet-shape top
- 10" pneumatic height adjustment for sitting or standing work area
- Five-star base with locking casters
- Freestanding

Freight Class: 125

<b>HW_MT24</b>	24" x 28" x 23-33"	Cubic Ft: 16.7	Ship Weight: 45	<b>701</b>	<b>712</b>	<b>722</b>
<b>HW_MT30</b>	30" x 28" x 23-33"	Cubic Ft: 16.7	Ship Weight: 60	<b>758</b>	<b>769</b>	<b>782</b>

### Spanner Island

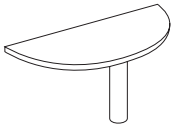

- Top + column
- 5" diameter base with powdercoated black finish and leveling glide
- Use at end of back-to-back returns, shells or credenzas
- Assembly required

Freight Class: 85

<b>HW_ST60</b>	60" x 30" x 29"	Cubic Ft: 7.21	Ship Weight: 96	<b>776</b>	<b>788</b>	<b>799</b>
<b>HW_ST48</b>	48" x 24" x 29"	Cubic Ft: 4.8	Ship Weight: 66	<b>643</b>	<b>653</b>	<b>662</b>

### End Table

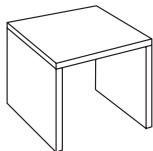

- Multiple uses
- Assembly required

Freight Class: 85

<b>HW_ET23</b>	<b>QS</b>	22" x 24" x 18"	Cubic Ft: 2.1	Ship Weight: 30	<b>297</b>	<b>301</b>	<b>306</b>
----------------	-----------	-----------------	---------------	-----------------	------------	------------	------------

**QS FINISHES WC**

FINISH SELECTION

NATURAL MAPLE **FM** | WINDSOR CHERRY **WC** | MAHOGANY **M** | GRAPHITE **GP** | MEDIUM OAK **O** | ASPEN **AP** | PEARWOOD **PW** | BLACK **E** | ESPRESSO **X** | GREY **G** | CLASSIC CHERRY **CC** |

SIN 711-2 **HYPERWORK**

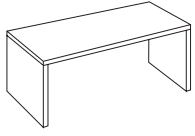
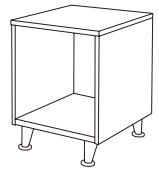
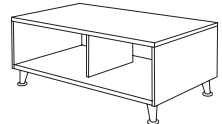
		Zone Pricing		1	2	3
<b>Coffee Table</b>	 <ul style="list-style-type: none"> <li>• Multiple uses</li> <li>• Requires assembly</li> </ul> <p>Freight Class: 85</p>	<b>HW_CT20</b>	<b>QS</b> 48" x 24" x 15" Cubic Ft: 3.6 Ship Weight: 50	<b>355</b>	<b>360</b>	<b>366</b>
		<b>QS FINISHES WC</b>				
<b>Coffee Table</b>	 <ul style="list-style-type: none"> <li>• Open storage/display shelf and top</li> <li>• Angled satin finish chrome legs with stationary feet to match Claudia reception series</li> <li>• Ships fully assembled</li> </ul> <p>Freight Class: 150</p>	<b>HW_ET18</b>	18" x 22" x 24" Cubic Ft: 6.9 Ship Weight: 50	<b>529</b>	<b>537</b>	<b>545</b>
<b>Coffee Table</b>	 <ul style="list-style-type: none"> <li>• Open storage/display shelf and top</li> <li>• Angled satin finish chrome legs with stationary feet to match Claudia reception series</li> <li>• Ships fully assembled</li> </ul> <p>Freight Class: 150</p>	<b>HW_CT48</b>	48" x 24" x 18" Cubic Ft: 11.9 Ship Weight: 96	<b>681</b>	<b>691</b>	<b>701</b>

CONTEMPORARY LAMINATE



## CHARACTERISTICS

- Non-handed for quick, easy changes and reconfiguration.
- Freestanding pedestals
- Shells shipped flat
- Non-locking
- Integrates with complete Hyperwork line

## FINISHES

– ALL COLORS ARE THE SAME PRICE –  
All finishes are thermally fused laminates unless otherwise noted. **A high pressure laminate top option is available for a 15% pricing upcharge and a six-week lead time will apply.** High pressure laminate tops are only offered in **Windsor Cherry, Mahogany and Grey.** Contact your customer service representative to discuss specific high pressure laminate needs and to obtain delivery quotes.

## FINISH COLORS

<b>AP</b> Aspen	<b>PW</b> Pearwood
<b>E</b> Black	<b>WC</b> Windsor Cherry
<b>FM</b> Natural Maple	<b>G</b> Grey
<b>GP</b> Graphite	<b>X</b> Espresso
<b>M</b> Mahogany	<b>CC</b> Classic Cherry
<b>O</b> Medium Oak	

## PULL OPTIONS

Choose curvilinear pulls in brushed chrome, ebony or bright brass or oval nickel drawer/door pulls all constructed of solid metal. When ordering, use the corresponding pull designator at the beginning of the model number.

<b>GW</b> Brushed Chrome
<b>GE</b> Ebony
<b>GB</b> Bright Brass
<b>GD</b> Oval Nickel

## PEDESTALS

All pedestals are fully assembled, freestanding with wrench adjustable leg levelers pre-installed. Pedestal case are Graphite color thermally fused laminate with 3mm PVC edgebanding. Drawer fronts are 3/4" thermally fused laminate with 3mm PVC edgebanding.

Agility pedestals feature standard graphite (GP) cases; specify drawer front color.

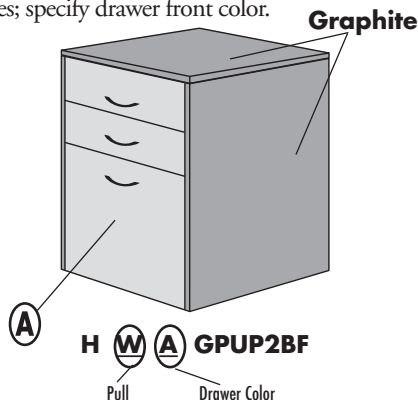

## TOPS

All tops are 1" thick with thermally fused laminate surface, proper backing and full 3 millimeter PVC AdvantEdge banding as required. All bridge and return tops feature common gain direction with connecting units.

## SHELLS

All shells ship flat and require assembly. Metal fasteners (cam/pin) allow quick, easy assembly with power screwdriver.

Agility shells are available in two-tone color combinations (top vs base). For monochrome units, specify one finish.

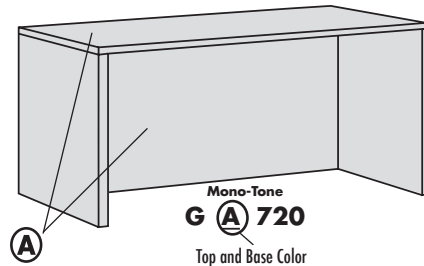
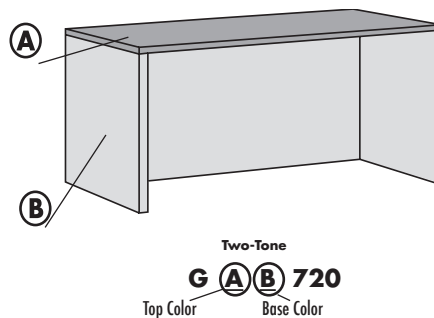

## PANELS

End panels are 1" thick core with thermally fused laminate on both sides and full 3 millimeter PVC AdvantEdge banding as required. Full modesty panels are 3/4" thick core with thermally fused laminate on both sides and full 3 millimeter PVC AdvantEdge banding as required. Heavy-duty, wrench adjustable nylon leveling glides furnished.

## DRAWERS

All drawer fronts are constructed of 3/4" thick core with thermally fused laminate on both sides and full 3 millimeter PVC AdvantEdge banding as required. Drawer sides are 1/2" thick vinyl wrap with oak grain pattern. Drawer bottoms are 1/8" thick hardboard with oak grain pattern.

- All box drawers suspended on smooth-action steel, ball-bearing slides 3/4" extension
- File and lateral file drawers mounted on heavy-duty, ball-bearing, full-extension slides
- All file and lateral file drawers constructed for suspended filing with 25 lb. maximum weight for bottom-loading

- Drawers constructed with 5 sides for extra strength and durability. Drawer front is the fifth side and is removable for field-repair or hardware additions

## FILING

- All file drawers include pre-installed, black filing hardware with easy-adjust crossbar
- All file drawers accommodate letter-size filing front-to-back and letter- or legal-size filing side-to-side
- All lateral file drawers accommodate letter or legal-size filing side-to-side and letter or legal size filing front-to-back

## WIRE MANAGEMENT

See features for number of grommets and location. Additional grommets can be added for extended wire management capability at \$106 list per grommet. Add G after SKU number. Includes factory cut and installed grommet and black sleeve. Call for special quote. Specify location and quote number with order.

## QUICKSHIP

Quick Ship is not available on any items ordered with option.

## PACKING

All units are properly packed in heavy-duty cartons with reinforced corner pads. All packaging conforms to, or exceeds, specifications as outlined in the Uniform Freight Classification.

All file units are shipped set up. All shells ship flat.

## PALLETIZATION

See page 3.

## CARE AND CLEANING INSTRUCTIONS

Normal cleaning: Clean using a soft cloth and a good window cleaner which contains no ammonia, followed by wiping dry using a dry soft cloth.

**Specifications subject to change without notice.**



## FINISH SELECTION

NATURAL MAPLE **FM** | WINDSOR CHERRY **WC** | MAHOGANY **M** |  
 GRAPHITE **GP** | MEDIUM OAK **O** | ASPEN **AP** | PEARWOOD **PW** |  
 BLACK **E** | ESPRESSO **X** | GREY **G** | CLASSIC CHERRY **CC** |

SIN 711-2 **AGILITY**

## Configurations

Zone  
Pricing

1

2

3

### Bow Front Desk

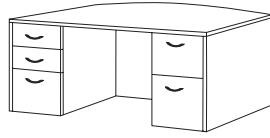

72" x 36" x 29"

Description	Model Number	Qty	Frts. Class	Cubic Ft.	Ship Weight				
Bow Front Desk Shell	G_720B 72" x 36" x 29"	1	85	5.6	158	<b>718</b>	<b>729</b>	<b>740</b>	
Box/Box/File Pedestal	G__GPUP2BF 15.75" x 22" x 27.75"	1	100	9.8	86	<b>504</b>	<b>512</b>	<b>519</b>	
File/File Pedestal	G__GPUPF 15.75" x 22" x 27.75"	1	100	9.8	86	<b>504</b>	<b>512</b>	<b>519</b>	
Total:							<b>1726</b>	<b>1753</b>	<b>1778</b>

### L-Shaped Workstation

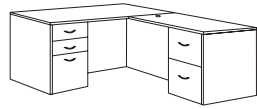

72" x 84" x 29"

Description	Model Number	Qty	Frts. Class	Cubic Ft.	Ship Weight				
Rectangular Desk Shell	G_720 72" x 36" x 29"	1	85	5.6	168	<b>499</b>	<b>506</b>	<b>514</b>	
Return Shell	G_722 48" x 24" x 29"	1	85	3.0	84	<b>321</b>	<b>326</b>	<b>331</b>	
Box/Box/File Pedestal	G__GPUP2BF 15.75" x 22" x 27.75"	1	100	9.8	86	<b>504</b>	<b>512</b>	<b>519</b>	
File/File Pedestal	G__GPUPF 15.75" x 22" x 27.75"	1	100	9.8	86	<b>504</b>	<b>512</b>	<b>519</b>	
Total:							<b>1828</b>	<b>1856</b>	<b>1883</b>

### Executive U-Shaped Workstation



72" x 108" x 65"

Description	Model Number	Qty	Frts. Class	Cubic Ft.	Ship Weight				
Bow Front Desk Shell	G_720B 72" x 36" x 29"	1	85	5.6	158	<b>718</b>	<b>729</b>	<b>740</b>	
Credenza Shell	G_724 72" x 24" x 29"	1	85	4.4	132	<b>384</b>	<b>390</b>	<b>396</b>	
Box/Box/File Pedestal	G__GPUP2BF 15.75" x 22" x 27.75"	1	100	9.8	86	<b>504</b>	<b>512</b>	<b>519</b>	
Lateral File Pedestal	G__GPULF 30.5" x 22" x 27.75"	1	100	15.5	125	<b>748</b>	<b>759</b>	<b>770</b>	
Bridge	HW_485 48" x 24" x 29"	1	100	4.0	66	<b>422</b>	<b>428</b>	<b>435</b>	
Overhead Storage Unit with Doors	H__737 72" x 16" x 36.5"	1	125	33.6	221	<b>1199</b>	<b>1217</b>	<b>1235</b>	
Total:							<b>3975</b>	<b>4035</b>	<b>4095</b>

## Desks

### Bow Front Desk Shell

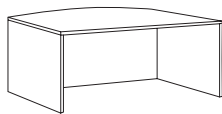

Freight Class: 85

- 1" thick top
- Thermally fused laminate
- AdvantEdge 3 mm PVC banding
- Adjustable levelers with reinforced steel plate
- Assembly required

**G\_720B** 72" X 36" X 29" Cubic Ft: 5.6 Ship Weight: 158 **718** **729** **740**

### Rectangular Desk Shell

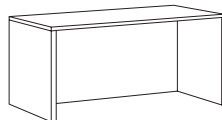

Freight Class: 85

- 1" thick top
- Thermally fused laminate
- AdvantEdge 3 mm PVC banding
- Adjustable levelers with reinforced steel plate
- Assembly required

**G\_720** 72" X 36" X 29" Cubic Ft: 5.6 Ship Weight: 168 **499** **506** **514**

### Rectangular Desk Shell

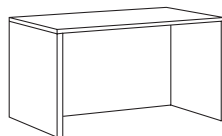

Freight Class: 85



- 1" thick top
- Thermally fused laminate
- AdvantEdge 3 mm PVC banding
- Adjustable levelers with reinforced steel plate
- Assembly required

**G\_660** 66" X 30" X 29" Cubic Ft: 4.4 Ship Weight: 145 **449** **456** **462**

CONTEMPORARY LAMINATE

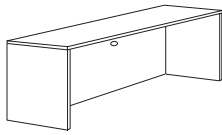
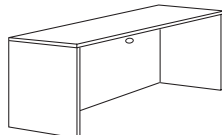
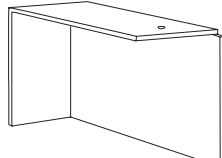
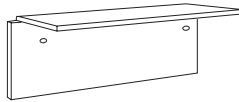

G **FM** 724  
Finish

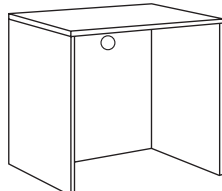
				Zone Pricing	1	2	3
<p><b>Credenza Shell</b></p>  <p>Freight Class: 85</p> <ul style="list-style-type: none"> <li>• 1" thick top</li> <li>• Thermally fused laminate</li> <li>• AdvantEdge 3 mm PVC banding</li> <li>• Grommet in back panel</li> <li>• Adjustable levelers with reinforced steel plate</li> <li>• Assembly required</li> </ul>	<b>G_724</b>	72" X 24" X 29"	Cubic Ft: 4.4	Ship Weight: 132	<b>384</b>	<b>390</b>	<b>396</b>
<p><b>Credenza Shell</b></p>  <p>Freight Class: 85</p> <ul style="list-style-type: none"> <li>• 1" thick top</li> <li>• Thermally fused laminate</li> <li>• AdvantEdge 3 mm PVC banding</li> <li>• Grommet in back panel</li> <li>• Adjustable levelers with reinforced steel plate</li> <li>• Assembly required</li> </ul>	<b>G_624</b>	66" X 24" X 29"	Cubic Ft: 4	Ship Weight: 121	<b>352</b>	<b>357</b>	<b>363</b>
<p><b>Return Shell</b></p>  <p>Freight Class: 85</p> <ul style="list-style-type: none"> <li>• 1" thick top</li> <li>• Thermally fused laminate</li> <li>• AdvantEdge 3 mm PVC banding</li> <li>• Grommet in top</li> <li>• Adjustable levelers with reinforced steel plate</li> <li>• Assembly required</li> </ul>	<b>G_722</b>	48" X 24" X 29"	Cubic Ft: 3	Ship Weight: 84	<b>321</b>	<b>326</b>	<b>331</b>
<p><b>Bridge</b></p>  <p>Freight Class: 100</p> <ul style="list-style-type: none"> <li>• 1" thick top</li> <li>• Thermally fused laminate</li> <li>• AdvantEdge 3 mm PVC banding</li> <li>• Two grommets in modesty panel</li> <li>• Assembly required</li> </ul>	<b>HW_485</b>	<b>QS</b> 48" X 24" X 29"	Cubic Ft: 4	Ship Weight: 66	<b>422</b>	<b>428</b>	<b>435</b>
<p><b>Mobile Worktable</b></p>  <p>Freight Class: 85</p> <ul style="list-style-type: none"> <li>• Casters for mobility</li> <li>• Two locking casters</li> <li>• Assembly required</li> </ul>	<b>G_324S</b>	33" X 24" X 29"	Cubic Ft: 3	Ship Weight: 80	<b>623</b>	<b>632</b>	<b>642</b>
<p><b>Lateral File Shell/ Computer Worktable</b></p>  <p>Freight Class: 85</p> <ul style="list-style-type: none"> <li>• Computer desk application</li> <li>• 29" desk height</li> <li>• Grommet in back panel</li> <li>• Lateral file application with lateral file pedestal</li> <li>• Assembly required</li> </ul>	<b>G_324</b>	33" X 24" X 29"	Cubic Ft: 3	Ship Weight: 95	<b>562</b>	<b>570</b>	<b>579</b>

## FINISH SELECTION

NATURAL MAPLE **FM** | WINDSOR CHERRY **WC** | MAHOGANY **M** |  
 GRAPHITE **GP** | MEDIUM OAK **O** | ASPEN **AP** | PEARWOOD **PW** |  
 BLACK **E** | ESPRESSO **X** | GREY **G** | CLASSIC CHERRY **CC** |

# SIN 711-2 AGILITY

Zone  
Pricing

1

2

3

### Lateral File (Shell + Pedestal)

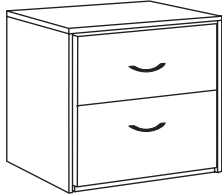

- Shell requires assembly
- Pedestal fully assembled
- Letter or legal filing
- Pedestal sides/top Graphite color standard, specify drawer front and shell finish
- Ships in two cartons

Freight Class: 100

**G\_346** 33" X 24" X 29" Cubic Ft: 18.5 Ship Weight: 220 **1187** **1205** **1223**

**Pulls:** BRUSHED CHROME **GW** EBONY **GE** BRIGHT BRASS **GB** OVAL NICKEL **GD**

### Box/Box/File Pedestal

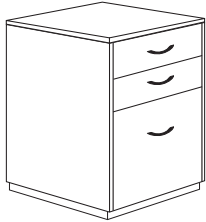

- Box/box/file drawers
- Steel ball-bearing drawer slides
- Pre-installed black filing hardware
- Letter or legal filing
- Pedestal sides/top Graphite color standard, specify drawer front finish
- Ships fully assembled

Freight Class: 100

**G\_GPUP2BF** 15.75" X 22" X 27.75" Cubic Ft: 9.8 Ship Weight: 86 **504** **512** **519**

**Pulls:** BRUSHED CHROME **GW** EBONY **GE** BRIGHT BRASS **GB** OVAL NICKEL **GD**

### File/File Pedestal

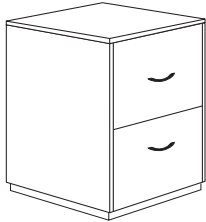

- File/file drawers
- Pre-installed black filing hardware
- Letter or legal filing
- Pedestal sides/top Graphite color standard, specify drawer front finish
- Ships fully assembled

Freight Class: 100

**G\_GPUPF** 15.75" X 22" X 27.75" Cubic Ft: 9.8 Ship Weight: 86 **504** **512** **519**

**Pulls:** BRUSHED CHROME **GW** EBONY **GE** BRIGHT BRASS **GB** OVAL NICKEL **GD**

### Lateral File Pedestal



- Two lateral file drawers
- Pre-installed black filing hardware
- Letter or legal filing
- Pedestal sides/top Graphite color standard, specify drawer front finish
- Ships fully assembled

Freight Class: 100

**G\_GPULF** 30.5" X 22" X 27.75" Cubic Ft: 15.5 Ship Weight: 125 **748** **759** **770**

**Pulls:** BRUSHED CHROME **GW** EBONY **GE** BRIGHT BRASS **GB** OVAL NICKEL **GD**

CONTEMPORARY LAMINATE



### FINISH OPTIONS

- |                         |                          |
|-------------------------|--------------------------|
| <b>AP</b> Aspen         | <b>PW</b> Pearwood       |
| <b>E</b> Black          | <b>WC</b> Windsor Cherry |
| <b>FM</b> Natural Maple | <b>G</b> Grey            |
| <b>GP</b> Graphite      | <b>X</b> Espresso        |
| <b>M</b> Mahogany       | <b>CC</b> Classic Cherry |
| <b>O</b> Medium Oak     |                          |

### WALL-MOUNT OVERHEADS

**Mounts anywhere and frees work surface space**

- 3/4 thermally fused laminate
- 3 mm PVC AdvantEdge banding
- Cam & pin construction
- No assembly required
- Mount to wall studs for safety

### 3-IN-1 MULTICARRELS

Multitude of uses and applications! Great use-anywhere desking! Side-by-Side connectability.

### Three Worksurface Heights

- Desk 29"
- Wheelchair 32"
- Standing 39"
- Bookshelf above/below work surface

### Wire Management

- Cutouts at work surface and bookshelf
- Pass thru cutouts on Add-On unit
- Cord channel included

### Setup

5 minutes (first piece) with power screwdriver.



### QUICKSHIP

Quick Ship is not available on any items ordered with option.

### CARE & CLEANING INSTRUCTIONS

**Normal cleaning:** Clean using a soft cloth and a good window cleaner which contains no ammonia, followed by wiping dry using a dry soft cloth.

**Specifications subject to change without notice.**

		Zone Pricing	1	2	3	
<b>Wall-Mount Overheads</b>						
<b>Wall-Mount Overhead-Open</b>						
	<ul style="list-style-type: none"> <li>• Open storage</li> <li>• Accepts 11.5" H binders</li> <li>• Inside dimensions: 33" W x 13.75" D x 12" H</li> </ul>	<b>UW_317W</b>	35.5" X 16.5" X 14.5" Cubic Ft: 9.0 Ship Weight: 61	<b>519</b>	<b>527</b>	<b>535</b>
Freight Class: 125						
<b>Wall-Mount Overhead-Doors</b>						
	<ul style="list-style-type: none"> <li>• Two side-opening doors</li> <li>• Accepts 11.5" H binders</li> <li>• Inside dimensions: 33" W x 13.75" D x 12" H</li> </ul>	<b>UW_337W</b>	35.5" X 16.5" X 14.5" Cubic Ft: 9.0 Ship Weight: 72	<b>753</b>	<b>764</b>	<b>776</b>
Freight Class: 125						
<b>Wall-Mount Overhead-Flip Door</b>						
	<ul style="list-style-type: none"> <li>• Flip up door</li> <li>• Accepts 11.5" H binders</li> <li>• Inside dimensions: 33" W x 13.75" D x 11.5" H</li> </ul>	<b>UW_337FDW</b>	35.5" X 16.5" X 14.5" Cubic Ft: 9.0 Ship Weight: 73	<b>753</b>	<b>764</b>	<b>776</b>
Freight Class: 125						

FINISH SELECTION

ASPEN **AP** | WINDSOR CHERRY **WC** | BLACK **E** | NATURAL MAPLE **FM** |  
 GRAPHITE **GP** | MAHOGANY **M** | MEDIUM OAK **O** | PEARWOOD **PW** | ESPRESSO **X** |  
 GREY **G** | CLASSIC CHERRY **CC** |

SIN 711-2 **UNIWORK**

3-IN-1 Multicarrels

Zone Pricing	1	2	3
--------------	---	---	---

Freestanding 3-IN-1 MultiCarrel

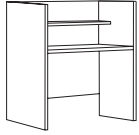

- Worksurface: 34" W x 26" D
- Shelf: 34" W x 11" D
- 1" and 3/4" thermally fused laminate
- AdvantEdge 3mm PVC edges
- Leg levelers included
- Assembly required

Freight Class: 100

<b>UWSC_3630</b>	36" X 30" X 48"	Cubic Ft: 3.1	Ship Weight: 117	<b>753</b>	<b>764</b>	<b>776</b>
------------------	-----------------	---------------	------------------	------------	------------	------------

Add-On 3-IN-1 MultiCarrel

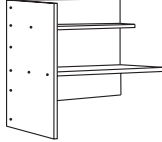

- Same description as above except:
- Connects with freestanding MultiCarrel

Freight Class: 100

<b>UWSC_3630A</b>	35" X 30" X 48"	Cubic Ft: 3.1	Ship Weight: 89	<b>622</b>	<b>631</b>	<b>641</b>
-------------------	-----------------	---------------	-----------------	------------	------------	------------

CONTEMPORARY LAMINATE



## FINISHES

**Mahogany, Medium Oak, Gunstock Walnut and Windsor Cherry wood grain thermally fused laminate.**

## PEDESTALS AND FILE CABINETS

All cases are surfaced on both sides with thermally fused laminate and edge banded as required. Units fully assembled with dowels, glue, wood cleats, metal brackets and screws. Series features full modesty panels.

## TOPS

1 1/8" thick tops are surfaced in thermally fused laminate. Tops feature a reversed coped shape on connecting ends of bridges and returns. This ensures smooth work surface at the connection with the desk or credenza. All tops feature full radius styling with softly rounded edges on all four sides, plus softly rounded shaping on all four corners. Ends of all tops feature solid hardwood rails.

## DRAWERS

All drawer fronts are surfaced on both sides with thermally fused laminate and edge banded as required. Drawer sides and bottoms are printed with an oak grain pattern.

- All box drawers are suspended on smooth-action metal slides with ball bearings
- All file drawers and file cabinet drawers are mounted on heavy-duty ball bearing, full-extension slides
- All file drawers are fitted for letter size filing front-to-back; or legal size filing from side-to-side
- 36" lateral file drawers allow legal and or letter filing front-to-back or legal size filing from side-to-side
- 30" lateral file drawers allow legal filing side-to-side and letter filing front-to-back
- Black filing hardware includes pre-installed rails with easy-adjust crossbars
- Maximum weight for bottom loading is 25 lb
- Drawers are constructed with 5 sides for extra strength and durability. The drawer front is the 5th side and is removable in the field for repairs or hardware additions

## TACK BOARDS

Fabric covered tackable boards may be ordered separately to fit inside hutches. They can be ordered with any fabric to match office chairs. Leather or vinyl not available.

## PANELS

End panels are surfaced on both sides with thermally fused laminate and edge banded as required. Heavy-duty adjustable nylon leveling glides in 5" steel plate on all units.

## GROMMETS

All grommets in the 2200 Series are round and made of black high impact poly resin. See features for number of grommets and location. Additional grommets can be added for extended wire management capability at \$106 list per grommet. Includes factory cut and installed grommet and black sleeve. Call for special quote. Specify location and quote number with order.

## HARDWARE

Brass plated drawer pulls are standard on all lateral file and storage cabinets. All other drawers feature flush drawer fronts with concealed side pulls. Pulls are available at an upcharge on those models. Please specify "P" after model number for drawer pulls and add \$38 to list price for double pedestal desks and double pedestal credenzas. Add \$19 to list for single pedestal desks, credenzas or returns.

## LOCKS

- Individually locking pedestals are standard on all desks and credenzas
- Two drawer lateral files feature individually locking drawers
- Three and four drawer lateral files feature central locking and are keyed different than other locks due to the anti-tilt mechanism inside the unit
- All locks (except three and four drawer lateral files) are keyed identical unless otherwise specified
- 'Key Different' option is \$21 list upcharge per lock. Locks/cores packaged to customer requirements
- Additional lead time for 'Key Different'
- For optional locking on overhead storage units with four wood doors, add Y to the end of the model number and add \$150 to the list price of unit

## ACCESSORIES *Factory Installed*

Certain accessories can be ordered installed prior to shipment. Add letter designator (C or K) at end of the desk or credenza model number:

- C** Center Drawer  
*Example: FRM2220C*
- K** Keyboard Platform  
*Example: FRM2276LK*
- T** Task Light  
*Example: FRM2280T*

## QUICKSHIP

Quick Ship is not available on any items ordered with option.

## PACKING

All units are properly packed in heavy duty cartons with heavy duty corner pads. All packaging conforms to or exceeds specifications as outlined in the Uniform Freight Classification.

All desks, credenzas, files, and overhead storage units are shipped set up. Modular L-shaped, and U-shaped workstations are shipped in multiple cartons and require connection in the field.

## PALLETIZATION

See Page 3.

## CARE AND CLEANING INSTRUCTIONS

Normal cleaning: Clean using a soft cloth and a good window cleaner which contains no ammonia, followed by wiping dry using a dry soft cloth.

**Specifications subject to change without notice.**



FINISH SELECTION

MAHOGANY **M** | WINDSOR CHERRY **WC** | MEDIUM OAK **O** | GUNSTOCK WALNUT **W** |

SIN 711-2 **2200 SERIES**

**Configurations**

Zone Pricing	1	2	3
--------------	---	---	---

**L-Shaped Workstation**

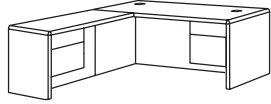

72" x 84" x 29"

Description	Model Number	Qty	Frft.Class	Cubic Ft.	Ship Weight				
Right Pedestal Desk	FR_2263AR 72" x 36" x 29"	1	200	51.6	250	<b>1134</b>	<b>1151</b>	<b>1168</b>	
Desk Height Left Return	FR_2263BL 48" x 24" x 29"	1	110	24.3	144	<b>717</b>	<b>728</b>	<b>739</b>	
Total:					75.90	394	<b>1851</b>	<b>1879</b>	<b>1907</b>

**Modular Peninsula Workstation**

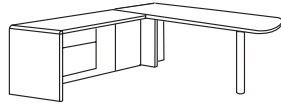

72" x 84" x 29"

Description	Model Number	Qty	Frft.Class	Cubic Ft.	Ship Weight				
Peninsula Desk	FR_799 72" x 36" x 29"	1	125	51.6	160	<b>1103</b>	<b>1120</b>	<b>1136</b>	
Desk Height Left Return	FR_2263BL 48" x 24" x 29"	1	110	24.3	144	<b>717</b>	<b>728</b>	<b>739</b>	
Total:					75.90	304	<b>1820</b>	<b>1848</b>	<b>1875</b>

**U-Shaped Workstation with Peninsula Desk**

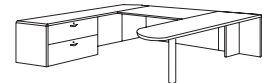

72" x 108" x 29"

Description	Model Number	Qty	Frft.Class	Cubic Ft.	Ship Weight				
Peninsula Desk	FR_799 72" x 36" x 29"	1	125	51.6	160	<b>1103</b>	<b>1120</b>	<b>1136</b>	
Bridge	FR_2260 48" x 24" x 29"	1	100	4.0	65	<b>337</b>	<b>342</b>	<b>347</b>	
Left Lateral File Credenza	FR_2233L 72" x 24" x 29"	1	125	35.7	259	<b>1366</b>	<b>1386</b>	<b>1407</b>	
Total:					91.30	484	<b>2806</b>	<b>2848</b>	<b>2890</b>

**U-Shaped Workstation**



72" x 108" x 65.5"

Description	Model Number	Qty	Frft.Class	Cubic Ft.	Ship Weight				
Right Pedestal Desk	FR_2263AR 72" x 36" x 29"	1	200	51.6	250	<b>1134</b>	<b>1151</b>	<b>1168</b>	
Bridge	FR_2260 48" x 24" x 29"	1	100	4.0	65	<b>337</b>	<b>342</b>	<b>347</b>	
Left Lateral File Credenza	FR_2233L 72" x 24" x 29"	1	125	35.7	259	<b>1366</b>	<b>1386</b>	<b>1407</b>	
Overhead Storage Unit	FR_2280 70" x 17" x 36.5"	1	125	30.5	225	<b>1224</b>	<b>1242</b>	<b>1261</b>	
Total:					121.80	799	<b>4061</b>	<b>4121</b>	<b>4183</b>

**Desks**

**Double Pedestal Desk**

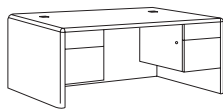

- Two box drawers
- Two file drawers
- Pre-installed filing hardware for letter or legal filing
- Two wire management grommets
- Individually locking pedestals

<b>FR_2220 QS</b>	60" X 30" X 29"	Cubic Ft: 36.7	Ship Weight: 263	<b>1170</b>	<b>1188</b>	<b>1205</b>
	<b>Center Drawer C</b>			160	162	165
<b>FR_2225 QS</b>	66" X 30" X 29"	Cubic Ft: 40.2	Ship Weight: 284	<b>1293</b>	<b>1312</b>	<b>1332</b>
	<b>Center Drawer C</b>			172	175	177
<b>FR_2230 QS</b>	72" X 36" X 29"	Cubic Ft: 51.6	Ship Weight: 312	<b>1379</b>	<b>1400</b>	<b>1420</b>
	<b>Center Drawer C</b>			172	175	177

Freight Class: 110

**QS FINISHES M**

**Pulls:** Brass Drawer Pull **P. \$38**

UNIT	KNEESPACE	OVERHANG
72" Double Pedestal Desk	38-1/4"	10-3/8"
66" Double Pedestal Desk	32-1/4"	4-3/8"
60" Double Pedestal Desk	26-1/4"	4-3/8"
66" Double Pedestal Credenza	32-1/4"	n/a

TRANSITIONAL LAMINATE

# 2200 SERIES SIN 711-2

Edge Profile



How to Order

FR **M** 6002BFF

Finish

Zone Pricing	1	2	3
--------------	---	---	---

## Double Full Pedestal Desk

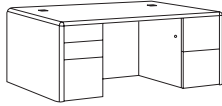

- Box/Box/File left pedestal
- File/File right pedestal
- Pre-installed filing hardware for letter or legal filing
- Individually locking pedestals

<b>FR_6002BFF</b> 60" X 30" X 29" Cubic Ft: 36.7 Ship Weight: 300	<b>1521</b>	<b>1544</b>	<b>1567</b>
<b>Center Drawer C</b>	160	162	165
<b>FR_6602BFF</b> 66" X 30" X 29" Cubic Ft: 40.2 Ship Weight: 325	<b>1679</b>	<b>1704</b>	<b>1729</b>
<b>Center Drawer C</b>	172	175	177
<b>FR_7202BFF</b> 72" X 36" X 29" Cubic Ft: 51.6 Ship Weight: 353	<b>1793</b>	<b>1820</b>	<b>1847</b>
<b>Center Drawer C</b>	172	175	177

Freight Class: 110

**Pulls:** Brass Drawer Pull **P \$38**

## Left Pedestal Desk

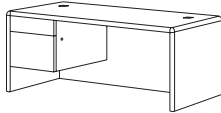

- One box drawer
- One file drawer
- Pre-installed filing hardware for letter or legal filing
- Two wire management grommets
- Locking pedestal
- Use with return or bridge and single pedestal credenza

<b>FR_2263AL QS</b> 72" X 36" X 29" Cubic Ft: 51.6 Ship Weight: 250	<b>1134</b>	<b>1151</b>	<b>1168</b>
Freight Class: 200	<b>Center Drawer C</b>	160	162
<b>FR_2243AL QS</b> 66" X 30" X 29" Cubic Ft: 40.2 Ship Weight: 208	<b>1031</b>	<b>1046</b>	<b>1062</b>
Freight Class: 110	<b>Center Drawer C</b>	160	162
<b>FR_2231AL</b> 48" X 30" X 29" Cubic Ft: 30.1 Ship Weight: 179	<b>853</b>	<b>866</b>	<b>879</b>
Freight Class: 110	<b>Center Drawer C</b>	160	162

**QS FINISHES M**

**Pulls:** Brass Drawer Pull **P \$19**

## Right Pedestal Desk

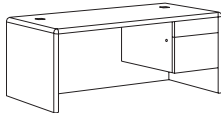

- One box drawer
- One file drawer
- Pre-installed filing hardware for letter or legal filing
- Two wire management grommets
- Locking pedestal
- Use with return or bridge and single pedestal credenza

<b>FR_2263AR QS</b> 72" X 36" X 29" Cubic Ft: 51.6 Ship Weight: 250	<b>1134</b>	<b>1151</b>	<b>1168</b>
Freight Class: 200	<b>Center Drawer C</b>	160	162
<b>FR_2243AR QS</b> 66" X 30" X 29" Cubic Ft: 40.2 Ship Weight: 208	<b>1031</b>	<b>1046</b>	<b>1062</b>
Freight Class: 110	<b>Center Drawer C</b>	160	162
<b>FR_2231AR</b> 48" X 30" X 29" Cubic Ft: 30.1 Ship Weight: 179	<b>853</b>	<b>866</b>	<b>879</b>
Freight Class: 110	<b>Center Drawer C</b>	160	162

**QS FINISHES M**

**Pulls:** Brass Drawer Pull **P \$19**

## Single Full Pedestal Desk (Left Shown)

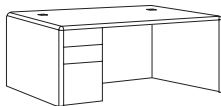

- Box/Box/File pedestal
- Legal or letter filing
- Locking pedestal
- Two wire management grommets in top
- Use with return or bridge and single pedestal credenza

<b>FR_651L2BF</b> 66" X 30" X 29" Cubic Ft: 40.2 Ship Weight: 230	<b>1339</b>	<b>1359</b>	<b>1379</b>
Freight Class: 110	<b>Center Drawer C</b>	160	162
<b>FR_721L2BF</b> 72" X 36" X 29" Cubic Ft: 51.6 Ship Weight: 272	<b>1474</b>	<b>1496</b>	<b>1518</b>
Freight Class: 200	<b>Center Drawer C</b>	160	162
<b>FR_651R2BF</b> 66" X 30" X 29" Cubic Ft: 40.2 Ship Weight: 230	<b>1339</b>	<b>1359</b>	<b>1379</b>
Freight Class: 110	<b>Center Drawer C</b>	160	162
<b>FR_721R2BF</b> 72" X 36" X 29" Cubic Ft: 51.6 Ship Weight: 272	<b>1474</b>	<b>1496</b>	<b>1518</b>
Freight Class: 200	<b>Center Drawer C</b>	160	162

**Pulls:** Brass Drawer Pull **P \$19**

## Peninsula Desk

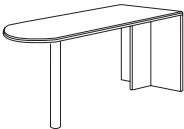

- 4" black finish cylinder base with leveling glide
- Use with L-shaped and U-shaped workstations

<b>FR_799 QS</b> 72" X 36" X 29" Cubic Ft: 51.6 Ship Weight: 160	<b>1103</b>	<b>1120</b>	<b>1136</b>
<b>FR_699</b> 60" X 30" X 29" Cubic Ft: 40.2 Ship Weight: 140	<b>903</b>	<b>917</b>	<b>930</b>

**QS FINISHES M**

Freight Class: 125

## Credenzas

### Computer Credenza

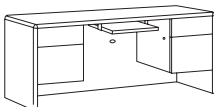

- Two box drawers
- Two file drawers
- Pre-installed filing hardware for letter or legal filing
- One wire management grommet in modesty panel
- Individually locking pedestals
- Pullout keyboard platform standard

<b>FR_2264 QS</b> 66" X 24" X 29" Cubic Ft: 32.8 Ship Weight: 252	<b>1318</b>	<b>1338</b>	<b>1358</b>
<b>FR_2274 QS</b> 72" X 24" X 29" Cubic Ft: 35.7 Ship Weight: 285	<b>1409</b>	<b>1430</b>	<b>1451</b>

**QS FINISHES M**

**Pulls:** Brass Drawer Pull **P \$38**

Freight Class: 110

TRANSITIONAL LAMINATE

FINISH SELECTION

MAHOGANY **M** | WINDSOR CHERRY **WC** | MEDIUM OAK **O** | GUNSTOCK WALNUT **W** |

SIN 711-2 **2200 SERIES**

Zone Pricing	1	2	3
--------------	---	---	---

**Double Full Pedestal Credenzas**

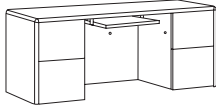

- File/File pedestals
- Legal or letter filing
- Pre-installed filing hardware
- Individually locking pedestals
- Pullout keyboard platform standard
- One grommet in modesty panel

Freight Class: 110

<b>FR_744F</b>	72" X 24" X 29"	Cubic Ft: 35.7	Ship Weight: 312	<b>1859</b>	<b>1887</b>	<b>1915</b>
<b>FR_644F</b>	66" X 24" X 29"	Cubic Ft: 32.8	Ship Weight: 301	<b>1767</b>	<b>1794</b>	<b>1820</b>
<b>FR_642F</b>	60" X 24" X 29"	Cubic Ft: 30.5	Ship Weight: 276	<b>1567</b>	<b>1591</b>	<b>1614</b>

**Pulls:** Brass Drawer Pull **P \$38**

**Credenzas with CPU Storage**

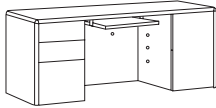

- Box/Box/File left pedestal
- Pre-installed filing hardware for legal or letter filing
- Locking left pedestal
- CPU storage with door right
- Pullout keyboard platform standard
- One grommet in modesty panel and three in CPU storage

Freight Class: 110

<b>FR_715CPR</b>	72" X 24" X 29"	Cubic Ft: 35.7	Ship Weight: 300	<b>1763</b>	<b>1789</b>	<b>1816</b>
<b>FR_615CPR</b>	60" X 24" X 29"	Cubic Ft: 30.5	Ship Weight: 280	<b>1196</b>	<b>1214</b>	<b>1232</b>

**Pulls:** Brass Drawer Pull **P \$38**

**Storage Credenza**

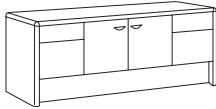

- Two box drawers
- Two file drawers
- Pre-installed filing hardware for letter or legal filing
- Storage compartment with one adjustable shelf behind 2 hinged doors
- Individually locking pedestals
- Locks behind doors

Freight Class: 125

<b>FR_2266</b>	66" X 24" X 29"	Cubic Ft: 32.8	Ship Weight: 301	<b>1360</b>	<b>1380</b>	<b>1401</b>
<b>FR_2272</b>	72" X 24" X 29"	Cubic Ft: 35.7	Ship Weight: 312	<b>1429</b>	<b>1450</b>	<b>1472</b>

**Pulls:** Brass Drawer Pull **P \$38**

**Full Pedestal Storage Credenza**

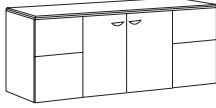

- File/File pedestals
- Pre-installed filing hardware for letter or legal filing
- Storage compartment with one adjustable shelf behind 2 hinged doors
- Individually locking pedestals
- Locks behind doors

Freight Class: 125

<b>FR_714F</b>	72" X 24" X 29"	Cubic Ft: 35.7	Ship Weight: 350	<b>1763</b>	<b>1789</b>	<b>1816</b>
----------------	-----------------	----------------	------------------	-------------	-------------	-------------

**Pulls:** Brass Drawer Pull **P \$38**

**Left Pedestal Credenza**

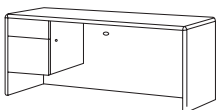

- One box drawer
- One file drawer
- Pre-installed filing hardware for letter or legal filing
- One wire management grommet in modesty panel
- Locking pedestal
- Use with bridge and single pedestal desk

Freight Class: 125

<b>FR_2276L</b>	72" X 24" X 29"	Cubic Ft: 35.7	Ship Weight: 226	<b>974</b>	<b>989</b>	<b>1003</b>
			<b>Keyboard Platform K</b>	196	199	202
<b>FR_625L</b>	66" X 24" X 29"	Cubic Ft: 32.8	Ship Weight: 185	<b>914</b>	<b>928</b>	<b>941</b>
			<b>Keyboard Platform K</b>	196	199	202
<b>FR_615L</b>	60" X 24" X 29"	Cubic Ft: 30.5	Ship Weight: 170	<b>901</b>	<b>915</b>	<b>928</b>
			<b>Keyboard Platform K</b>	196	199	202

**Pulls:** Brass Drawer Pull **P \$19**

**Right Pedestal Credenza**

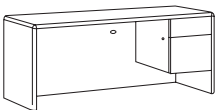

- One box drawer
- One file drawer
- Pre-installed filing hardware for letter or legal filing
- One wire management grommet in modesty panel
- Locking pedestal
- Use with bridge and single pedestal desk

Freight Class: 125

<b>FR_2276R</b>	72" X 24" X 29"	Cubic Ft: 35.7	Ship Weight: 226	<b>974</b>	<b>989</b>	<b>1003</b>
			<b>Keyboard Platform K</b>	196	199	202
<b>FR_625R</b>	66" X 24" X 29"	Cubic Ft: 32.8	Ship Weight: 185	<b>914</b>	<b>928</b>	<b>941</b>
			<b>Keyboard Platform K</b>	196	199	202
<b>FR_615R</b>	60" X 24" X 29"	Cubic Ft: 30.5	Ship Weight: 170	<b>901</b>	<b>915</b>	<b>928</b>
			<b>Keyboard Platform K</b>	196	199	202

**Pulls:** Brass Drawer Pull **P \$19**

TRANSITIONAL LAMINATE

# 2200 SERIES SIN 711-2

Edge Profile



How to Order

FR	M	725LF
	Finish	

Zone Pricing	1	2	3
--------------	---	---	---

### Left Full Pedestal Credenza

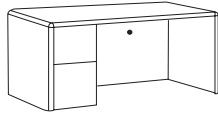

- File/File pedestal
- Pre-installed filing hardware for letter or legal filing
- Locking pedestal
- One wire management grommet in modesty panel

<b>FR_725LF</b>	72" X 24" X 29"	Cubic Ft: 35.7	Ship Weight: 243	<b>1267</b>	<b>1286</b>	<b>1305</b>
	<b>Keyboard Platform K</b>			196	199	202
<b>FR_625LF</b>	66" X 24" X 29"	Cubic Ft: 32.8	Ship Weight: 199	<b>1159</b>	<b>1176</b>	<b>1194</b>
	<b>Keyboard Platform K</b>			196	199	202
<b>FR_615LF</b>	60" X 24" X 29"	Cubic Ft: 30.5	Ship Weight: 189	<b>1148</b>	<b>1165</b>	<b>1182</b>
	<b>Keyboard Platform K</b>			196	199	202

Freight Class: 125

**Pulls:** Brass Drawer Pull **P \$19**

### Right Full Pedestal Credenza

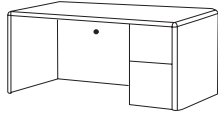

- Same description as above

<b>FR_725RF</b>	72" X 24" X 29"	Cubic Ft: 35.7	Ship Weight: 243	<b>1267</b>	<b>1286</b>	<b>1305</b>
	<b>Keyboard Platform K</b>			196	199	202
<b>FR_625RF</b>	66" X 24" X 29"	Cubic Ft: 32.8	Ship Weight: 199	<b>1159</b>	<b>1176</b>	<b>1194</b>
	<b>Keyboard Platform K</b>			196	199	202
<b>FR_615RF</b>	60" X 24" X 29"	Cubic Ft: 30.5	Ship Weight: 189	<b>1148</b>	<b>1165</b>	<b>1182</b>
	<b>Keyboard Platform K</b>			196	199	202

Freight Class: 125

**Pulls:** Brass Drawer Pull **P \$19**

### Left Lateral File Credenza

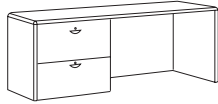

- Two lateral file drawers
- Pre-installed filing hardware for letter or legal filing
- Individual locking drawers
- Use with bridge and single pedestal desk
- Pulls standard

<b>FR_2233L QS</b>	72" X 24" X 29"	Cubic Ft: 35.7	Ship Weight: 259	<b>1366</b>	<b>1386</b>	<b>1407</b>
	<b>QS FINISHES</b>	<b>M</b>			<b>EXTRA THICK BOTTOM</b>	\$160 <b>H</b>

Freight Class: 125

### Right Lateral File Credenza

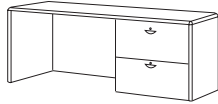

- Two lateral file drawers
- Pre-installed filing hardware for letter or legal filing
- Individual locking drawers
- Use with bridge and single pedestal desk
- Pulls standard

<b>FR_2233R QS</b>	72" X 24" X 29"	Cubic Ft: 35.7	Ship Weight: 259	<b>1366</b>	<b>1386</b>	<b>1407</b>
	<b>QS FINISHES</b>	<b>M</b>			<b>EXTRA THICK BOTTOM</b>	\$160 <b>H</b>

Freight Class: 125

### MultiFile Credenza



(Left Shown)

- One lateral file drawer with lock
- One file drawer
- Two box drawers
- Pre-installed filing hardware for letter or legal filing
- HOT PROJECTS ACCESS SLOT
- Use with bridge and single pedestal desk
- Pulls standard

<b>FR_735L</b>	72" X 24" X 29"	Cubic Ft: 35.7	Ship Weight: 269	<b>1521</b>	<b>1544</b>	<b>1567</b>
<b>FR_735R</b>	72" X 24" X 29"	Cubic Ft: 35.7	Ship Weight: 269	<b>1521</b>	<b>1544</b>	<b>1567</b>
					<b>EXTRA THICK BOTTOM</b>	\$80 <b>H</b>

Freight Class: 125

## Returns & Bridges

### MultiFile Return



(Left Shown)

- One lateral file drawer with lock
- One file drawer
- Two box drawers
- Pre-installed filing hardware for letter or legal filing
- HOT PROJECTS ACCESS SLOT
- Connects with single pedestal desks
- Top has a reversed edge detail to ensure a solid, smooth work surface
- Pulls standard

<b>FR_735LRT</b>	72" X 24" X 29"	Cubic Ft: 35.7	Ship Weight: 253	<b>1403</b>	<b>1424</b>	<b>1445</b>
	<b>Keyboard Platform K</b>			196	199	202
<b>FR_735RRT</b>	72" X 24" X 29"	Cubic Ft: 35.7	Ship Weight: 253	<b>1403</b>	<b>1424</b>	<b>1445</b>
	<b>Keyboard Platform K</b>			196	199	202
					<b>EXTRA THICK BOTTOM</b>	\$80 <b>H</b>

Freight Class: 110

TRANSITIONAL LAMINATE

FINISH SELECTION

MAHOGANY **M** | WINDSOR CHERRY **WC** | MEDIUM OAK **O** | GUNSTOCK WALNUT **W** |

SIN 711-2 **2200 SERIES**

**Full File/File Pedestal Returns**

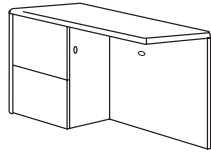

(Left Shown)

- File/File pedestal
- Legal or letter filing
- Locking pedestal
- Top has a reversed edge detail to ensure a solid, smooth work surface
- One grommet in modesty panel

Freight Class: 110

**Full Box/Box Pedestal Returns**

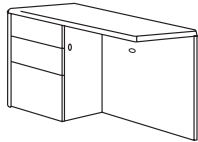

(Left Shown)

- Box/Box/File pedestal
- Legal or letter filing
- Locking pedestal
- Top has a reversed edge detail to ensure a solid, smooth work surface
- One grommet in modesty panel

Freight Class: 110

**Machine Height Left Return**

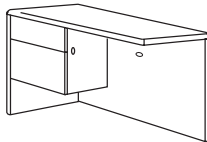

Freight Class: 110

- One box drawer
- One file drawer, letter or legal filing
- One wire management grommet in modesty panel
- Locking pedestal
- Top has a reversed edge detail to ensure a solid, smooth worksurface
- Connects with single pedestal desks

**Machine Height Right Return**

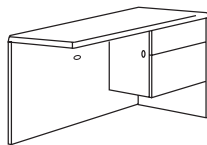

Freight Class: 110

- One box drawer
- One file drawer, letter or legal filing
- One wire management grommet in modesty panel
- Locking pedestal
- Top has a reversed edge detail to ensure a solid, smooth worksurface
- Connects with single pedestal desks

**Desk Height Left Return**

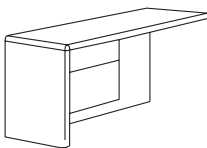

Freight Class: 110

- One box drawer
- One file drawer, letter or legal filing
- One wire management grommet
- Locking pedestal
- Top has a reversed edge detail to ensure a solid, smooth work surface
- Connects with single pedestal desks

Zone Pricing	1	2	3
--------------	---	---	---

<b>FR_762LF</b> 60" X 24" X 29" Cubic Ft: 30.5 Ship Weight: 179	<b>998</b>	<b>1013</b>	<b>1028</b>
<b>Keyboard Platform K</b>	196	199	202
<b>FR_762RF</b> 60" X 24" X 29" Cubic Ft: 30.59 Ship Weight: 179	<b>998</b>	<b>1013</b>	<b>1028</b>
<b>Keyboard Platform K</b>	196	199	202
<b>FR_722LF</b> 48" X 24" X 29" Cubic Ft: 24.3 Ship Weight: 161	<b>931</b>	<b>945</b>	<b>959</b>
<b>Keyboard Platform K</b>	196	199	202
<b>FR_722RF</b> 48" X 24" X 29" Cubic Ft: 24.3 Ship Weight: 161	<b>931</b>	<b>945</b>	<b>959</b>
<b>Keyboard Platform K</b>	196	199	202
<b>FR_622LF</b> 42" X 24" X 29" Cubic Ft: 21.5 Ship Weight: 155	<b>858</b>	<b>871</b>	<b>884</b>
<b>Keyboard Platform K</b>	196	199	202
<b>FR_622RF</b> 42" X 24" X 29" Cubic Ft: 21.5 Ship Weight: 155	<b>858</b>	<b>871</b>	<b>884</b>
<b>Keyboard Platform K</b>	196	199	202

**Pulls:** Brass Drawer Pull **P \$19**

<b>FR_722L2BF</b> 48" X 24" X 29" Cubic Ft: 24.3 Ship Weight: 166	<b>931</b>	<b>945</b>	<b>959</b>
<b>Keyboard Platform K</b>	196	199	202
<b>FR_722R2BF</b> 48" X 24" X 29" Cubic Ft: 24.3 Ship Weight: 166	<b>931</b>	<b>945</b>	<b>959</b>
<b>Keyboard Platform K</b>	196	199	202

**Pulls:** Brass Drawer Pull **P \$19**

<b>FR_2243BL</b> 42" X 24" X 26" Cubic Ft: 19.6 Ship Weight: 137	<b>717</b>	<b>728</b>	<b>739</b>
--	------------	------------	------------

**Pulls:** Brass Drawer Pull **P \$19**

<b>FR_2243BR</b> 42" X 24" X 26" Cubic Ft: 19.6 Ship Weight: 137	<b>717</b>	<b>728</b>	<b>739</b>
--	------------	------------	------------

**Pulls:** Brass Drawer Pull **P \$19**

<b>FR_762L</b> 60" X 24" X 29" Cubic Ft: 30.6 Ship Weight: 162	<b>786</b>	<b>798</b>	<b>810</b>
--	------------	------------	------------

**Keyboard Platform K** 196 199 202

<b>FR_2263BL QS</b> 48" X 24" X 29" Cubic Ft: 24.3 Ship Weight: 144	<b>717</b>	<b>728</b>	<b>739</b>
---	------------	------------	------------

**Keyboard Platform K** 196 199 202

<b>FR_622L</b> 42" X 24" X 29" Cubic Ft: 21.5 Ship Weight: 140	<b>658</b>	<b>668</b>	<b>678</b>
--	------------	------------	------------

**Keyboard Platform K** 196 199 202

**QS FINISHES M**

**Pulls:** Brass Drawer Pull **P \$19**

TRANSITIONAL LAMINATE

# 2200 SERIES SIN 711-2

Edge Profile



How to Order

FR **M** 2263BR  
Finish

Zone Pricing	1	2	3
--------------	---	---	---

## Desk Height Right Return

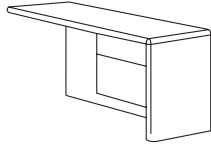

- One box drawer
- One file drawer, letter or legal filing
- One wire management grommet
- Locking pedestal
- Top has a reversed edge detail to ensure a solid, smooth work surface
- Connects with single pedestal desks

Freight Class: 110

<b>FR_762R</b>	60" X 24" X 29"	Cubic Ft: 30.6	Ship Weight: 162	<b>786</b>	<b>798</b>	<b>810</b>
	<b>Keyboard Platform K</b>			196	199	202
<b>FR_2263BR QS</b>	48" X 24" X 29"	Cubic Ft: 24.3	Ship Weight: 144	<b>717</b>	<b>728</b>	<b>739</b>
	<b>Keyboard Platform K</b>			196	199	202
<b>FR_622R</b>	42" X 24" X 29"	Cubic Ft: 21.5	Ship Weight: 140	<b>658</b>	<b>668</b>	<b>678</b>
	<b>Keyboard Platform K</b>			196	199	202

**QS FINISHES M** Pulls: Brass Drawer Pull **P \$19**

## Bridge

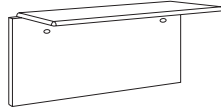

- Two wire management grommets in modesty panel
- Connects with single pedestal desks and credenzas
- Top has a reversed edge detail to ensure a solid, smooth work surface

Freight Class: 100

<b>FR_2260 QS</b>	48" X 24" X 29"	Cubic Ft: 4	Ship Weight: 65	<b>337</b>	<b>342</b>	<b>347</b>
<b>FR_484</b>	42" X 24" X 29"	Cubic Ft: 4	Ship Weight: 55	<b>305</b>	<b>310</b>	<b>314</b>

**QS FINISHES M**

## Storage, Filing & Bookcases

### Overhead Bookcase Hutch



- Fits on 37" lateral file, two-door storage unit or MultiFile
- Grommet in back panel
- 2 adjustable shelves

Freight Class: 125

<b>FR_3066</b>	34.5" X 17" X 36.5"	Cubic Ft: 15.3	Ship Weight: 125	<b>566</b>	<b>574</b>	<b>583</b>
----------------	---------------------	----------------	------------------	------------	------------	------------

### Overhead Storage Unit

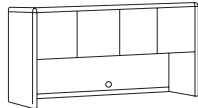

- Two storage compartments
- 21" clearance under compartments
- 2280 fits 72" credenza
- 2278 fits 66" credenza
- 2268 fits 60" credenza
- 2245 fits 48" desk
- Tack board available
- Includes full back panel with grommet

Freight Class: 125

<b>FR_2280 QS</b>	70" X 17" X 36.5"	Cubic Ft: 30.5	Ship Weight: 225	<b>1224</b>	<b>1242</b>	<b>1261</b>
	<b>Task Light T</b>			124	126	128
	<b>LED Task Light L</b>			212	215	218
<b>FR_2278 QS</b>	64" X 17" X 36.5"	Cubic Ft: 28.3	Ship Weight: 208	<b>1213</b>	<b>1231</b>	<b>1249</b>
	<b>Task Light T</b>			124	126	128
	<b>LED Task Light L</b>			212	215	218
<b>FR_2268</b>	57.75" X 17" X 36.5"	Cubic Ft: 28.3	Ship Weight: 185	<b>1213</b>	<b>1231</b>	<b>1249</b>
	<b>Task Light T</b>			124	126	128
	<b>LED Task Light L</b>			212	215	218
<b>FR_2245</b>	45" X 17" X 36.5"	Cubic Ft: 21.7	Ship Weight: 135	<b>837</b>	<b>850</b>	<b>862</b>
	<b>Task Light T</b>			124	126	128
	<b>LED Task Light L</b>			212	215	218

**QS FINISHES M** Pulls: Brass Drawer Pull **P \$38** Locks: 150\_Y

### Reception Screen for Main



- Fits 72" x 36" desks
- Non-skid rubber strips on bottom prohibit movement

Freight Class: 70

<b>FR_710</b>	69.75" X 33" X 14"	Cubic Ft: 31.9	Ship Weight: 140	<b>844</b>	<b>857</b>	<b>869</b>
---------------	--------------------	----------------	------------------	------------	------------	------------

### Reception Screen for Return

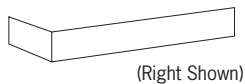

(Right Shown)

- Fits 42" x 24" desk height return
- Hardware included to join to main reception screen
- FR\_611L fits left return
- FR\_611R fits right return

Freight Class: 70

<b>FR_611L</b>	42" X 21" X 13"	Cubic Ft: 1.5	Ship Weight: 27	<b>223</b>	<b>226</b>	<b>230</b>
<b>FR_611R</b>	42" X 21" X 13"	Cubic Ft: 1.5	Ship Weight: 27	<b>223</b>	<b>226</b>	<b>230</b>









TRANSITIONAL LAMINATE

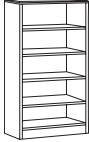

# FINISH SELECTION

MAHOGANY **M** | WINDSOR CHERRY **WC** | MEDIUM OAK **O** | GUNSTOCK WALNUT **W** |

# SIN 711-2 2200 SERIES

		Zone Pricing		1	2	3	
 <p><b>Five Shelf Bookcase</b></p> <ul style="list-style-type: none"> <li>• Three adjustable shelves</li> <li>• Bottom and second-from-bottom shelves fixed</li> <li>• 1" thick shelves</li> <li>• Back panel finished both sides</li> </ul>	<b>FR_65 QS</b>	36" X 17" X 65"	Cubic Ft: 31.9	Ship Weight: 244	<b>702</b>	<b>713</b>	<b>723</b>
	<b>FR_72</b>	36" X 17" X 72"	Cubic Ft: 35.6	Ship Weight: 250	<b>783</b>	<b>795</b>	<b>806</b>
		<b>QS FINISHES</b>		<b>M</b>			
Freight Class: 125							
 <p><b>Bookcase</b></p> <ul style="list-style-type: none"> <li>• Same as above except:</li> <li>• Two adjustable shelves in FR_48 (Shown)</li> <li>• One adjustable shelf in FR_36</li> <li>• Back panel finished both sides</li> </ul>	<b>FR_36</b>	36" X 17" X 36"	Cubic Ft: 18.5	Ship Weight: 100	<b>476</b>	<b>483</b>	<b>490</b>
	<b>FR_48</b>	36" X 17" X 48"	Cubic Ft: 24.2	Ship Weight: 120	<b>584</b>	<b>593</b>	<b>602</b>
Freight Class: 125							
 <p><b>Two-Door Bookcase</b></p> <ul style="list-style-type: none"> <li>• Two door enclosed storage area</li> <li>• Two adjustable shelves and one fixed shelf (above doors)</li> <li>• One adjustable shelf in cabinet</li> <li>• 1" thick shelves</li> <li>• Back panel finished both sides</li> </ul>	<b>FR_652D QS</b>	36" X 17" X 65"	Cubic Ft: 31.9	Ship Weight: 253	<b>842</b>	<b>855</b>	<b>867</b>
			<b>QS FINISHES</b>		<b>M</b>		
Freight Class: 125							
 <p><b>Standard Lateral File</b></p> <ul style="list-style-type: none"> <li>• Two lateral file drawers</li> <li>• Pre-installed hardware for letter of legal filing</li> <li>• Individually locking drawers</li> <li>• Anti-tilt counter weight</li> <li>• Pulls standard</li> </ul>	<b>FR_2226 QS</b>	31.5" X 21.75" X 29"	Cubic Ft: 31.9	Ship Weight: 253	<b>856</b>	<b>869</b>	<b>882</b>
			<b>QS FINISHES</b>		<b>M</b>	<b>EXTRA THICK BOTTOM</b>	\$160
Freight Class: 100							
 <p><b>Executive Lateral File</b></p> <ul style="list-style-type: none"> <li>• Two lateral file drawers</li> <li>• Pre-installed hardware for letter of legal filing</li> <li>• Individually locking drawers</li> <li>• Anti-tilt counter weight</li> <li>• Pulls standard</li> </ul>	<b>FR_2236 QS</b>	37" X 24" X 29"	Cubic Ft: 19	Ship Weight: 210	<b>911</b>	<b>925</b>	<b>938</b>
			<b>QS FINISHES</b>		<b>M</b>	<b>EXTRA THICK BOTTOM</b>	\$160
Freight Class: 100							
 <p><b>Multi-File</b></p> <ul style="list-style-type: none"> <li>• One lateral file drawer with lock</li> <li>• One file drawer</li> <li>• Two box drawers</li> <li>• Hot projects access slot</li> <li>• Pre-installed hardware for letter of legal filing</li> <li>• Pulls standard</li> </ul>	<b>FR_735</b>	37" X 24" X 29"	Cubic Ft: 19	Ship Weight: 220	<b>1285</b>	<b>1304</b>	<b>1324</b>
						<b>EXTRA THICK BOTTOM</b>	\$80
Freight Class: 100							
 <p><b>Three-Drawer Lateral File</b></p> <ul style="list-style-type: none"> <li>• Three lateral file drawers</li> <li>• Pre-installed hardware for letter of legal filing</li> <li>• Central locking (lock on front)</li> <li>• Anti-tilt mechanism prevents more than one drawer from opening at a time</li> <li>• Pulls standard</li> </ul>	<b>FR_3036</b>	31.5" X 21.75" X 44.5"	Cubic Ft: 27.9	Ship Weight: 220	<b>1678</b>	<b>1703</b>	<b>1728</b>
						<b>EXTRA THICK BOTTOM</b>	\$240
Freight Class: 100							
 <p><b>Four-Drawer Lateral File</b></p> <ul style="list-style-type: none"> <li>• Four lateral file drawers</li> <li>• Pre-installed hardware for letter of legal filing</li> <li>• Central locking (lock on front)</li> <li>• Anti-tilt mechanism prevents more than one drawer from opening at a time</li> <li>• Pulls standard</li> </ul>	<b>FR_2246</b>	31.5" X 20.75" X 56"	Cubic Ft: 27.9	Ship Weight: 252	<b>2154</b>	<b>2186</b>	<b>2219</b>
						<b>EXTRA THICK BOTTOM</b>	\$320
Freight Class: 100							

TRANSITIONAL LAMINATE

# 2200 SERIES SIN 711-2

Edge Profile



How to Order

FR **M** 65STOR  
Finish

Zone Pricing	1	2	3
--------------	---	---	---

### Storage Cabinet

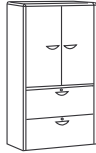

- Two lateral file drawers
- Pre-installed hardware for letter or legal filing
- Individually locking drawers
- Two adjustable shelves inside storage compartment
- Pulls standard

Freight Class: 125

<b>FR_65STOR QS</b>	37" X 24" X 65"	Cubic Ft: 43.1	Ship Weight: 357	<b>2227</b>	<b>2260</b>	<b>2294</b>
---------------------	-----------------	----------------	------------------	-------------	-------------	-------------

**QS FINISHES M**

**EXTRA THICK BOTTOM \$160 H**

### Two-Door Storage Unit

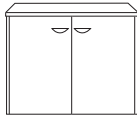

- Two hinged doors
- One adjustable shelf in storage area
- Leveling glides
- Inside dimensions: 34" X 21" X 25"
- Pulls standard

Freight Class: 125

<b>FR_732</b>	37" X 24" X 29"	Cubic Ft: 19.8	Ship Weight: 185	<b>798</b>	<b>810</b>	<b>822</b>
---------------	-----------------	----------------	------------------	------------	------------	------------

### Mobile Box/Box/File Pedestal



- Fits under work surfaces
- Box/Box File
- Pre-installed hardware for letter of legal filing
- Single-key front locking
- Four casters, two locking
- Pulls standard

Freight Class: 100

<b>FR_212BF</b>	16" X 22.25" X 27.25"	Cubic Ft: 10.25	Ship Weight: 105	<b>749</b>	<b>760</b>	<b>771</b>
-----------------	-----------------------	-----------------	------------------	------------	------------	------------

### Mobile File/File Pedestal



- Same description as above except:
- File/File

Freight Class: 100

<b>FR_21F</b>	16" X 22.25" X 27.25"	Cubic Ft: 10.3	Ship Weight: 105	<b>749</b>	<b>760</b>	<b>771</b>
---------------	-----------------------	----------------	------------------	------------	------------	------------

### MultiUse Wardrobe/Storage

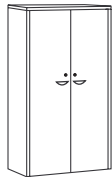

- Two-door storage area
- Coat rod mounted side-to-side on left side
- Four adjustable shelves right side
- Both sides drilled for adjustable shelves
- 1" thick shelves
- Individually locking doors
- Pulls standard

Freight Class: 125

<b>FR_65DWD</b>	37" X 24" X 65"	Cubic Ft: 43.1	Ship Weight: 300	<b>2082</b>	<b>2113</b>	<b>2144</b>
-----------------	-----------------	----------------	------------------	-------------	-------------	-------------

### Wardrobe

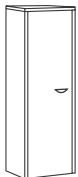

- Coat rod mounted side-to-side
- Adjustable shelf near bottom
- FR\_65WDL- Hinge on left
- FR\_65WDR- Hinge on right
- Shown with left hinge
- Pull standard

Freight Class: 125

<b>FR_65WDL</b>	24" X 24" X 65"	Cubic Ft: 31.6	Ship Weight: 200	<b>1416</b>	<b>1437</b>	<b>1458</b>
-----------------	-----------------	----------------	------------------	-------------	-------------	-------------

<b>FR_65WDR</b>	24" X 24" X 65"	Cubic Ft: 31.6	Ship Weight: 200	<b>1416</b>	<b>1437</b>	<b>1458</b>
-----------------	-----------------	----------------	------------------	-------------	-------------	-------------

## Center Drawer

### Center Drawer

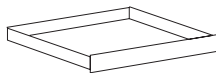

- CD\_18 fits 60" and 66" single pedestal desks
- CD\_19 fits 60" double pedestal and 72" 48" single pedestal desks
- CD\_32 fits 66" double pedestal desks
- CD\_30 fits 72" double pedestal desks

Freight Class: 100

<b>CD_18 QS</b>	20" X 18" X 3"	Cubic Ft: 1.5	Ship Weight: 11	<b>160</b>	<b>162</b>	<b>165</b>
-----------------	----------------	---------------	-----------------	------------	------------	------------

<b>CD_19 QS</b>	26" X 18" X 3"	Cubic Ft: 1.5	Ship Weight: 12	<b>160</b>	<b>162</b>	<b>165</b>
-----------------	----------------	---------------	-----------------	------------	------------	------------

<b>CD_32 QS</b>	32" X 18" X 3"	Cubic Ft: 2.2	Ship Weight: 13	<b>172</b>	<b>175</b>	<b>177</b>
-----------------	----------------	---------------	-----------------	------------	------------	------------

<b>CD_30 QS</b>	38" X 18" X 3"	Cubic Ft: 2.2	Ship Weight: 13	<b>172</b>	<b>175</b>	<b>177</b>
-----------------	----------------	---------------	-----------------	------------	------------	------------

Use with 2200 Series and Bravo Panel

TRANSITIONAL LAMINATE

## FINISH SELECTION

NATURAL MAPLE **FM** | MAHOGANY **M** | MEDIUM OAK **O** |  
GREY **G** | GUNSTOCK WALNUT **W** |

# SIN 711-2 BRAVO PANEL

## FINISHES

Finishes are available in **Grey, Mahogany, Gunstock Walnut, Medium Oak** and **Natural Maple** thermally fused laminate.

## PEDESTALS AND FILE CABINETS

All cases are thermally fused laminate surfaced on the outside and edge banded as required. Units fully assembled with dowels/glue, wood cleats, metal brackets and screws. Series features full modesty panels.

## TOPS

All tops are surfaced in thermally fused laminate with proper backing and edge banded as required.

## DRAWERS

All drawer fronts are thermally fused laminate surfaced on both sides with laminate and edge banded as required. Drawer sides and bottoms are printed with an oak grain pattern.

- All box drawers are suspended on smooth-action metal slides with ball bearings
- File cabinet drawers and file drawers are mounted on heavy-duty ball bearing, full-extension slides
- All file drawers are fitted for letter size filing front-to-back.
- File cabinet drawers are fitted for letter or legal size filing front-to-back or legal size filing from side-to-side
- All file drawers are constructed for suspended filing
- Black filing hardware includes pre-installed rails with easy-adjust crossbar
- Maximum weight for bottom loading is 25 lbs
- Drawers are constructed with 5 sides for extra strength and durability. The drawer front is the 5th side and is removable in the field for repairs or hardware additions

## TACK BOARDS

Fabric covered tackable boards may be ordered separately to fit inside hutches. They can be ordered with any fabric to match office chairs. Leather and vinyl not available.

## PANELS

1" end panels are surfaced on both sides with thermally fused laminate and edge banded as required. Heavy-duty adjustable nylon leveling glides in 5" steel plate in each end panel.

Unit	Kneespace	Overhang
72" Double Pedestal Desk	38 <sup>1</sup> / <sub>4</sub> "	10 <sup>3</sup> / <sub>8</sub> "
66" Double Pedestal Desk	32 <sup>1</sup> / <sub>4</sub> "	4 <sup>3</sup> / <sub>8</sub> "
60" Double Pedestal Desk	26 <sup>1</sup> / <sub>4</sub> "	4 <sup>3</sup> / <sub>8</sub> "
66" Double Pedestal Credenza	32 <sup>1</sup> / <sub>4</sub> "	NA

## WIRE MANAGEMENT

See features for number of grommets and location. Additional grommets can be added for extended wire management capability at \$106 list per grommet. Includes factory cut and installed grommet and black sleeve. Call for special quote. Specify location and quote number with order.

## HARDWARE

Black drawer pulls are standard on all file and storage cabinets. All other drawers feature flush drawer fronts with concealed side pulls. Pulls are available at an upcharge on those models. Please specify **P** after model number for drawer pulls and add \$38 to list price for double pedestal desks, double pedestal credenzas and lateral files. Add \$19 to list price for single pedestal desks, credenzas or returns.

## ACCESSORIES *Factory Installed*

Certain accessories can be ordered installed prior to shipment. Add letter designator (C, K or T) at end of the desk, credenza or overhead model number:

- C** Center Drawer  
*Example: BPM600C*
- K** Keyboard Platform  
*Example: BPM725RK*
- T** Task Light  
*Example: BPM677T*

## LOCKS

- Bravo Panel Series features individual locking pedestals
- Two drawer lateral files feature individual locking drawers.
- Four drawer lateral files feature central locking and are keyed different than other locks due to the anti-tilt mechanism inside the unit
- All locks are keyed identical unless otherwise specified
- 'Key Different' option is \$21 list upcharge per lock. Locks/cores packaged to customer requirements
- Additional lead time for 'Key Different'
- For optional locking on overhead storage units add **Y** to the end of the model number and add \$150 to the list price of units with four doors or two doors not adjoining. Add \$75 for units with two adjoining doors.

## QUICKSHIP

Quick Ship is not available on any items ordered with option.

## PACKING

All units are properly packed in heavy duty cartons with heavy duty corner pads. All packaging conforms to or exceeds specifications as outlined in the Uniform Freight Classification.

All desks, credenzas, files, and overhead storage units are shipped set up. Modular L-shaped, and U-shaped workstations are shipped in multiple cartons and require connection in the field.

## PALLETIZATION

See Page 3.

## CARE AND CLEANING INSTRUCTIONS

Normal cleaning: Clean using a soft cloth and a good window cleaner which contains no ammonia, followed by wiping dry using a dry soft cloth.

**Specifications subject to change without notice.**



## Desks

Zone Pricing	1	2	3
--------------	---	---	---

### Double Pedestal Desk

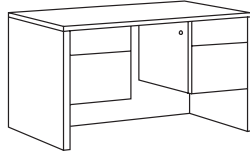

- Two box drawers
- Two file drawers
- Pre-installed filing hardware for legal or letter filing
- Individually locking pedestals

<b>BP_600 QS</b>	60" X 30" X 29" Cubic Ft: 36.7 Ship Weight: 235	<b>957</b>	<b>971</b>	<b>986</b>
	<b>Center Drawer C</b>	160	162	165
<b>BP_660</b>	66" X 30" X 29" Cubic Ft: 40.2 Ship Weight: 249	<b>1030</b>	<b>1045</b>	<b>1061</b>
	<b>Center Drawer C</b>	172	175	177
<b>BP_700</b>	72" X 30" X 29" Cubic Ft: 44.4 Ship Weight: 259	<b>1038</b>	<b>1054</b>	<b>1069</b>
	<b>Center Drawer C</b>	172	175	177
<b>BP_720 QS</b>	72" X 36" X 29" Cubic Ft: 51.6 Ship Weight: 289	<b>1138</b>	<b>1155</b>	<b>1172</b>
	<b>Center Drawer C</b>	172	175	177

Freight Class: 110

**QS FINISHES M** Pulls: BLACK DRAWER PULL **P \$38**

### Double Pedestal Bow Front Desk

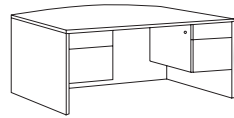

- Two box drawers
- Two file drawers
- Pre-installed filing hardware for legal or letter filing
- Individually locking pedestals

<b>BP_720B QS</b>	72" X 36" X 29" Cubic Ft: 51.6 Ship Weight: 289	<b>1278</b>	<b>1297</b>	<b>1316</b>
	<b>Center Drawer C</b>	172	175	177

Freight Class: 110

**QS FINISHES M** Pulls: BLACK DRAWER PULL **P \$38**

### Double Full Pedestal Desk

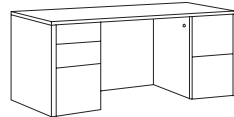

- Left Box/Box/File
- Right File/File
- Pre-installed, black filing hardware
- Letter or legal filing
- Individually locking pedestals
- BP\_720B2BFF includes a bow front

<b>BP_6002BFF</b>	60" X 30" X 29" Cubic Ft: 36.7 Ship Weight: 280	<b>1244</b>	<b>1263</b>	<b>1281</b>
	<b>Center Drawer C</b>	160	162	165
<b>BP_6602BFF</b>	66" X 30" X 29" Cubic Ft: 40.2 Ship Weight: 289	<b>1341</b>	<b>1361</b>	<b>1381</b>
	<b>Center Drawer C</b>	172	175	177
<b>BP_7002BFF</b>	72" X 30" X 29" Cubic Ft: 44.4 Ship Weight: 299	<b>1351</b>	<b>1371</b>	<b>1392</b>
	<b>Center Drawer C</b>	172	175	177
<b>BP_7202BFF</b>	72" X 36" X 29" Cubic Ft: 51.6 Ship Weight: 330	<b>1480</b>	<b>1502</b>	<b>1524</b>
	<b>Center Drawer C</b>	172	175	177
<b>BP_720B2BFF</b>	72" X 36" X 29" Cubic Ft: 51.6 Ship Weight: 325	<b>1662</b>	<b>1687</b>	<b>1712</b>
	<b>Center Drawer C</b>	172	175	177

Freight Class: 110

Pulls: BLACK DRAWER PULL **P \$38**

### Full Pedestal Computer Desk

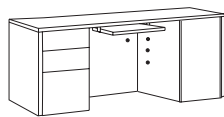

- Box/Box/File left pedestal
- Pre-installed, black filing hardware
- Letter or legal filing
- CPU cabinet with door right
- Locking pedestal
- Pullout keyboard platform standard
- One grommet in modesty panel and three in inside panel of CPU cabinet

<b>BP_700CPRK</b>	72" X 30" X 29" Cubic Ft: 44.4 Ship Weight: 290	<b>1594</b>	<b>1618</b>	<b>1642</b>
<b>BP_600CPRK</b>	60" X 30" X 29" Cubic Ft: 36.7 Ship Weight: 260	<b>1532</b>	<b>1555</b>	<b>1578</b>

Freight Class: 110

Pulls: BLACK DRAWER PULL **P \$38**

### Left Pedestal Desk

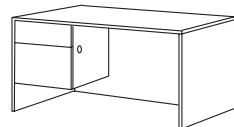

- One box drawer
- One file drawer
- Pre-installed filing hardware for legal or letter filing
- Locking pedestal

<b>BP_641L</b>	60" X 30" X 29" Cubic Ft: 36.7 Ship Weight: 197	<b>832</b>	<b>844</b>	<b>857</b>
	<b>Center Drawer C</b>	160	162	165
<b>BP_651L QS</b>	66" X 30" X 29" Cubic Ft: 40.2 Ship Weight: 203	<b>838</b>	<b>851</b>	<b>863</b>
	<b>Center Drawer C</b>	160	162	165
<b>BP_700L</b>	72" X 30" X 29" Cubic Ft: 44.4 Ship Weight: 225	<b>856</b>	<b>869</b>	<b>882</b>
	<b>Center Drawer C</b>	160	162	165
<b>BP_721L</b>	72" X 36" X 29" Cubic Ft: 51.6 Ship Weight: 243	<b>960</b>	<b>974</b>	<b>989</b>
	<b>Center Drawer C</b>	160	162	165

Freight Class: 200

**QS FINISHES M** Pulls: BLACK DRAWER PULL **P \$19**

UNIT	KNEESPACE	OVERHANG
72" Double Pedestal Desk	38-1/4"	10-3/8"
66" Double Pedestal Desk	32-1/4"	4-3/8"
60" Double Pedestal Desk	26-1/4"	4-3/8"
66" Double Pedestal Credenza	32-1/4"	n/a

FINISH SELECTION

NATURAL MAPLE **FM** | MAHOGANY **M** | MEDIUM OAK **O** | GREY **G** | GUNSTOCK WALNUT **W** |

SIN 711-2 **BRAVO PANEL**

**Right Pedestal Desk**

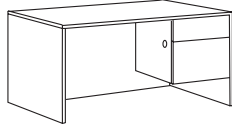

- One box drawer
- One file drawer
- Pre-installed filing hardware for legal or letter filing
- Locking pedestal

Freight Class: 200

**Left Pedestal Teacher Desk**

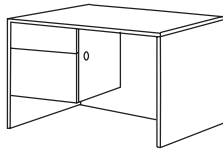

- One box drawer
- One file drawer
- Pre-installed filing hardware for legal or letter filing
- Locking pedestal

Freight Class: 110

**Right Pedestal Teacher Desk**

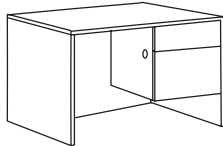

- One box drawer
- One file drawer
- Pre-installed filing hardware for legal or letter filing
- Locking pedestal

Freight Class: 110

**Left Pedestal Bow Front Desk**

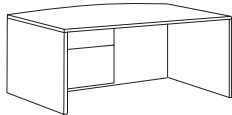

- One box drawer
- One file drawer
- Pre-installed filing hardware for legal or letter filing
- Locking pedestal

Freight Class: 200

**Right Pedestal Bow Front Desk**

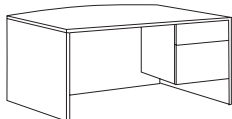

- One box drawer
- One file drawer
- Pre-installed filing hardware for legal or letter filing
- Locking pedestal

Freight Class: 200

**Left Full Pedestal Desk**

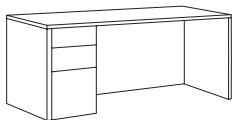

- Box/box/file pedestal left
- Pre-installed filing hardware for legal or letter filing
- Locking pedestal
- BP\_721LB2BF includes a bow front

		Zone Pricing	1	2	3
<b>BP_641R</b>	60" X 30" X 29" Cubic Ft: 36.7 Ship Weight: 197		<b>832</b>	<b>844</b>	<b>857</b>
	<b>Center Drawer C</b>		160	162	165
<b>BP_651R QS</b>	66" X 30" X 29" Cubic Ft: 40.2 Ship Weight: 203		<b>838</b>	<b>851</b>	<b>863</b>
	<b>Center Drawer C</b>		160	162	165
<b>BP_700R</b>	72" X 30" X 29" Cubic Ft: 44.4 Ship Weight: 225		<b>856</b>	<b>869</b>	<b>882</b>
	<b>Center Drawer C</b>		160	162	165
<b>BP_721R</b>	72" X 36" X 29" Cubic Ft: 51.6 Ship Weight: 243		<b>960</b>	<b>974</b>	<b>989</b>
	<b>Center Drawer C</b>		160	162	165

**QS FINISHES M**

**Pulls:** BLACK DRAWER PULL **P \$19**

<b>BP_481L</b>	48" X 30" X 29" Cubic Ft: 30.1 Ship Weight: 179		<b>825</b>	<b>837</b>	<b>850</b>
	<b>Center Drawer C</b>		160	162	165
	<b>Pulls:</b>		BLACK DRAWER PULL <b>P \$19</b>		

<b>BP_481R</b>	48" X 30" X 29" Cubic Ft: 30.1 Ship Weight: 179		<b>825</b>	<b>837</b>	<b>850</b>
	<b>Center Drawer C</b>		160	162	165
	<b>Pulls:</b>		BLACK DRAWER PULL <b>P \$19</b>		

<b>BP_721LB QS</b>	72" X 36" X 29" Cubic Ft: 51.6 Ship Weight: 243		<b>1210</b>	<b>1228</b>	<b>1246</b>
	<b>Center Drawer C</b>		160	162	165
	<b>QS FINISHES M</b>		<b>Pulls:</b> BLACK DRAWER PULL <b>P \$19</b>		

<b>BP_721RB QS</b>	72" X 36" X 29" Cubic Ft: 51.6 Ship Weight: 243		<b>1210</b>	<b>1228</b>	<b>1246</b>
	<b>Center Drawer C</b>		160	162	165
	<b>QS FINISHES M</b>		<b>Pulls:</b> BLACK DRAWER PULL <b>P \$19</b>		

<b>BP_721LB2BF</b>	72" X 36" X 29" Cubic Ft: 51.6 Ship Weight: 260		<b>1573</b>	<b>1597</b>	<b>1620</b>
Freight Class: 200	<b>Center Drawer C</b>		160	162	165
<b>BP_721L2BF</b>	72" X 36" X 29" Cubic Ft: 51.6 Ship Weight: 265		<b>1251</b>	<b>1270</b>	<b>1289</b>
Freight Class: 200	<b>Center Drawer C</b>		160	162	165
<b>BP_700L2BF</b>	72" X 30" X 29" Cubic Ft: 44.4 Ship Weight: 250		<b>1124</b>	<b>1141</b>	<b>1158</b>
Freight Class: 110	<b>Center Drawer C</b>		160	162	165
<b>BP_651L2BF</b>	66" X 30" X 29" Cubic Ft: 40.2 Ship Weight: 225		<b>1092</b>	<b>1108</b>	<b>1125</b>
Freight Class: 110	<b>Center Drawer C</b>		160	162	165
<b>BP_641L2BF</b>	60" X 30" X 29" Cubic Ft: 36.7 Ship Weight: 224		<b>1079</b>	<b>1095</b>	<b>1111</b>
Freight Class: 110	<b>Center Drawer C</b>		160	162	165

**Pulls:** BLACK DRAWER PULL **P \$19**

CONTEMPORARY LAMINATE



### Right Full Pedestal Desk

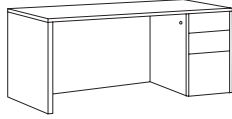

- Box/box/file pedestal right
- Pre-installed filing hardware for legal or letter filing
- Locking pedestal
- BP\_721RB2BF includes a bow front

	Zone Pricing	1	2	3
<b>BP_721RB2BF</b> 72" X 36" X 29" Cubic Ft: 51.6 Ship Weight: 260		<b>1573</b>	<b>1597</b>	<b>1620</b>
Freight Class: 200	<b>Center Drawer C</b>	160	162	165
<b>BP_721R2BF</b> 72" X 36" X 29" Cubic Ft: 51.6 Ship Weight: 265		<b>1251</b>	<b>1270</b>	<b>1289</b>
Freight Class: 200	<b>Center Drawer C</b>	160	162	165
<b>BP_700R2BF</b> 72" X 30" X 29" Cubic Ft: 44.4 Ship Weight: 250		<b>1124</b>	<b>1141</b>	<b>1158</b>
Freight Class: 110	<b>Center Drawer C</b>	160	162	165
<b>BP_651R2BF</b> 66" X 30" X 29" Cubic Ft: 40.2 Ship Weight: 225		<b>1092</b>	<b>1108</b>	<b>1125</b>
Freight Class: 110	<b>Center Drawer C</b>	160	162	165
<b>BP_641R2BF</b> 60" X 30" X 29" Cubic Ft: 36.7 Ship Weight: 224		<b>1079</b>	<b>1095</b>	<b>1111</b>
Freight Class: 110	<b>Center Drawer C</b>	160	162	165

**Pulls:** BLACK DRAWER PULL **P \$19**

### Left Full Pedestal Teachers Desk

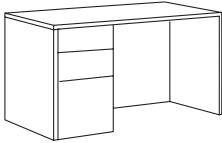

- Box/box/file pedestal left
- Pre-installed filing hardware for legal or letter filing
- Locking pedestal

Freight Class: 110

<b>BP_481L2BF</b> 48" X 30" X 29" Cubic Ft: 30.1 Ship Weight: 179		<b>1001</b>	<b>1016</b>	<b>1031</b>
	<b>Center Drawer C</b>	160	162	165

**Pulls:** BLACK DRAWER PULL **P \$19**

### Right Full Pedestal Teachers Desk

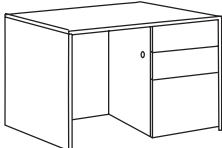

- Box/box/file pedestal right
- Pre-installed filing hardware for legal or letter filing
- Locking pedestal

Freight Class: 110

<b>BP_481R2BF</b> 48" X 30" X 29" Cubic Ft: 30.1 Ship Weight: 179		<b>1001</b>	<b>1016</b>	<b>1031</b>
	<b>Center Drawer C</b>	160	162	165

**Pulls:** BLACK DRAWER PULL **P \$19**

### Peninsula Desk

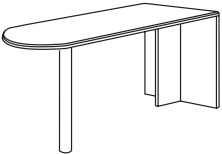

- End support panel
- Steel cylinder base is black - 4" in diameter with leveling glide
- Use with returns or bridges with single pedestal credenzas
- End panels are edge banded on all 4 sides

Freight Class: 125

<b>BP_799</b> 72" X 36" X 29" Cubic Ft: 51.6 Ship Weight: 160		<b>729</b>	<b>740</b>	<b>751</b>
<b>BP_699</b> 66" X 30" X 29" Cubic Ft: 40.2 Ship Weight: 140		<b>627</b>	<b>636</b>	<b>646</b>

## Computer Corner Desks

### Left Pedestal Computer Corner Desk

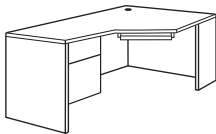

- Use with right return, or bridge and credenza
- 72" x 36"/24" worksurface with 24" hook up
- Easy computer pullup
- Locking box/ file left pedestal
- Pre-installed hardware for letter or legal filing
- One grommet in top, one in modesty panel
- Keyboard platform standard

Freight Class: 200

<b>BP_451L</b> 72" X 36/24" X 29" Cubic Ft: 51.6 Ship Weight: 232		<b>1626</b>	<b>1650</b>	<b>1675</b>
---	--	-------------	-------------	-------------

**Pulls:** BLACK DRAWER PULL **P \$19**

### Right Pedestal Computer Corner Desk

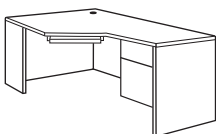

- Use with left return, or bridge and credenza
- 72" x 36"/24" worksurface with 24" hook up
- Easy computer pullup
- Locking box/ file right pedestal
- Pre-installed hardware for letter or legal filing
- One grommet in top, one in modesty panel
- Keyboard platform standard

Freight Class: 200

<b>BP_451R</b> 72" X 36/24" X 29" Cubic Ft: 51.6 Ship Weight: 232		<b>1626</b>	<b>1650</b>	<b>1675</b>
---	--	-------------	-------------	-------------

**Pulls:** BLACK DRAWER PULL **P \$19**



## FINISH SELECTION

NATURAL MAPLE **FM** | MAHOGANY **M** | MEDIUM OAK **O** |  
GREY **G** | GUNSTOCK WALNUT **W** |

# SIN 711-2 BRAVO PANEL

Zone Pricing	1	2	3
--------------	---	---	---

### Left Full Pedestal Computer Corner Desk

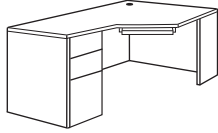

- Locking box/box/file left pedestal
- Use with right return, or bridge and credenza
- 72" x 36"/24" worksurface with 24" hook up
- Easy computer pullup
- Pre-installed hardware for letter or legal filing
- One grommet in top, one in modesty panel
- Keyboard platform standard

**BP\_451L2BF** 72" X 36/24" X 29" Cubic Ft: 51.6 Ship Weight: 269 **2061** **2092** **2123**

**Pulls:** BLACK DRAWER PULL **P \$19**

Freight Class: 200

### Right Full Pedestal Computer Corner Desk

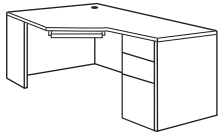

- Locking box/box/file right pedestal
- Use with left return, or bridge and credenza
- 72" x 36"/24" worksurface with 24" hook up
- Easy computer pullup
- Pre-installed hardware for letter or legal filing
- One grommet in top, one in modesty panel
- Keyboard platform standard

**BP\_451R2BF** 72" X 36/24" X 29" Cubic Ft: 51.6 Ship Weight: 269 **2061** **2092** **2123**

**Pulls:** BLACK DRAWER PULL **P \$19**

Freight Class: 200

## Computer Corners

### Connecting Computer Corner



- One wire management grommet on top and two in modesty panel
- Legs are 17" deep
- Can be used with connecting pieces or stand alone
- 24" hook ups

**BP\_449** 42" X 42" X 29" Cubic Ft: 34.3 Ship Weight: 152 **639** **649** **658**

**Keyboard Platform K** 196 199 202

Freight Class: 200

### Left Hand Connecting Intergrated Corner

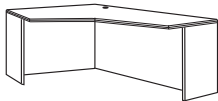

- One wire management grommet on top and one in modesty panel
- Legs are 17" deep
- Can be used with connecting pieces or stand alone
- 36" end is "hand" of unit
- 24" hook ups

**BP\_450L** 72" X 36/24" X 29" Cubic Ft: 51.6 Ship Weight: 222 **934** **948** **962**

**Keyboard Platform K** 196 199 202

Freight Class: 200

### Right Hand Connecting Intergrated Corner

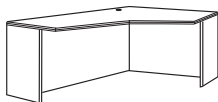

- One wire management grommet on top and one in modesty panel
- Legs are 17" deep
- Can be used with connecting pieces or stand alone
- 36" end is "hand" of unit
- 24" hook ups

**BP\_450R** 72" X 36/24" X 29" Cubic Ft: 51.6 Ship Weight: 222 **934** **948** **962**

**Keyboard Platform K** 196 199 202

Freight Class: 200

## Credenzas

### Storage Credenza

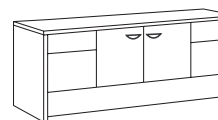

- Two box drawers
- Two file drawers, letter or legal filing
- Two hinged doors
- Storage compartment with adjustable shelf
- Locking pedestals
- Pulls are standard on doors but optional on drawers

**BP\_704** 72" X 24" X 29" Cubic Ft: 35.7 Ship Weight: 295 **1168** **1186** **1203**

**Pulls:** BLACK DRAWER PULL **P \$38**

Freight Class: 125

CONTEMPORARY LAMINATE



### Full Pedestal Storage Credenza

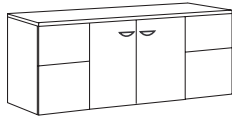

- Four file drawers, letter or legal filing
- Two hinged doors
- Storage compartment with adjustable shelf
- Locking pedestals
- Pulls are standard on doors but optional on drawers

Freight Class: 125

Zone Pricing	1	2	3
<b>BP_704F</b> 72" X 24" X 29" Cubic Ft: 35.7 Ship Weight: 295	<b>1519</b>	<b>1542</b>	<b>1565</b>

**Pulls:** BLACK DRAWER PULL **P \$38**

### Computer Credenza

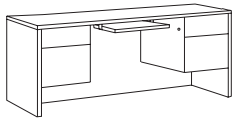

- Two box drawers
- Two file drawers
- Pre-installed filing hardware for letter or legal filing
- Individually locking pedestals
- One grommet in modesty panel
- Pullout keyboard platform standard

Freight Class: 110

<b>BP_642</b> 60" X 24" X 29" Cubic Ft: 30.5 Ship Weight: 227	<b>908</b>	<b>922</b>	<b>935</b>
---	------------	------------	------------

<b>BP_644 QS</b> 66" X 24" X 29" Cubic Ft: 32 Ship Weight: 251	<b>988</b>	<b>1003</b>	<b>1018</b>
--	------------	-------------	-------------

<b>BP_744 QS</b> 72" X 24" X 29" Cubic Ft: 35.7 Ship Weight: 275	<b>1021</b>	<b>1036</b>	<b>1052</b>
--	-------------	-------------	-------------

**QS FINISHES** **M**

**Pulls:** BLACK DRAWER PULL **P \$38**

### Full Pedestal Computer Credenza

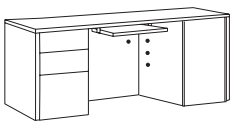

- Locking box/box/file drawer left pedestal
- Pre-installed, black filing hardware
- Letter or legal filing
- CPU cabinet with door on right
- One grommet in modesty panel and three in inside panel of CPU cabinet
- Pullout keyboard platform standard

Freight Class: 110

<b>BP_715CPR</b> 72" X 24" X 29" Cubic Ft: 35.7 Ship Weight: 295	<b>1472</b>	<b>1494</b>	<b>1516</b>
--	-------------	-------------	-------------

<b>BP_615CPR</b> 60" X 24" X 29" Cubic Ft: 30.5 Ship Weight: 280	<b>1410</b>	<b>1431</b>	<b>1452</b>
--	-------------	-------------	-------------

**Pulls:** BLACK DRAWER PULL **P \$38**

### Full Pedestal Computer Credenza

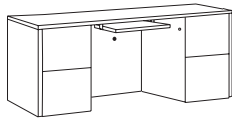

- Two locking file/file drawer pedestals
- Pre-installed, black filing hardware
- Letter or legal filing
- One grommet in modesty panel
- Pullout keyboard platform standard

Freight Class: 110

<b>BP_744F</b> 72" X 24" X 29" Cubic Ft: 35.7 Ship Weight: 300	<b>1349</b>	<b>1369</b>	<b>1389</b>
--	-------------	-------------	-------------

<b>BP_644F</b> 66" X 24" X 29" Cubic Ft: 32 Ship Weight: 285	<b>1285</b>	<b>1304</b>	<b>1324</b>
--	-------------	-------------	-------------

**Pulls:** BLACK DRAWER PULL **P \$38**

### Left Pedestal Credenza

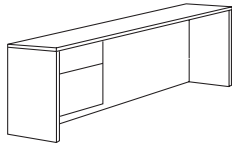

- One box drawer
- One file drawer
- Pre-installed filing hardware for letter or legal filing
- Locking pedestal
- One grommet in modesty panel

Freight Class: 125

<b>BP_725L QS</b> 72" X 24" X 29" Cubic Ft: 35.7 Ship Weight: 184	<b>832</b>	<b>844</b>	<b>857</b>
---	------------	------------	------------

<b>Keyboard Platform K</b>	196	199	202
----------------------------	-----	-----	-----

<b>BP_625L</b> 66" X 24" X 29" Cubic Ft: 32 Ship Weight: 174	<b>765</b>	<b>776</b>	<b>788</b>
--	------------	------------	------------

<b>Keyboard Platform K</b>	196	199	202
----------------------------	-----	-----	-----

<b>BP_615L</b> 60" X 24" X 29" Cubic Ft: 30.5 Ship Weight: 164	<b>742</b>	<b>753</b>	<b>764</b>
--	------------	------------	------------

<b>Keyboard Platform K</b>	196	199	202
----------------------------	-----	-----	-----

**QS FINISHES** **M**

**Pulls:** BLACK DRAWER PULL **P \$19**

### Right Pedestal Credenza

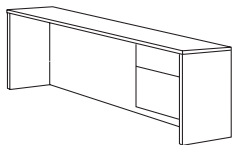

- One box drawer
- One file drawer
- Pre-installed filing hardware for letter or legal filing
- Locking pedestal
- One grommet in modesty panel

Freight Class: 125

<b>BP_725R QS</b> 72" X 24" X 29" Cubic Ft: 35.7 Ship Weight: 184	<b>832</b>	<b>844</b>	<b>857</b>
---	------------	------------	------------

<b>Keyboard Platform K</b>	196	199	202
----------------------------	-----	-----	-----

<b>BP_625R</b> 66" X 24" X 29" Cubic Ft: 32 Ship Weight: 174	<b>765</b>	<b>776</b>	<b>788</b>
--	------------	------------	------------

<b>Keyboard Platform K</b>	196	199	202
----------------------------	-----	-----	-----

<b>BP_615R</b> 60" X 24" X 29" Cubic Ft: 30.5 Ship Weight: 164	<b>742</b>	<b>753</b>	<b>764</b>
--	------------	------------	------------

<b>Keyboard Platform K</b>	196	199	202
----------------------------	-----	-----	-----

**QS FINISHES** **M**

**Pulls:** BLACK DRAWER PULL **P \$19**

### Single Full Pedestal Credenza

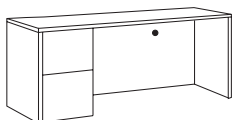

- File/file pedestal
- Pre-installed filing hardware for letter or legal filing
- Locking pedestal
- One wire management grommet in modesty panel
- Left pedestal shown (LF)

Freight Class: 125

<b>BP_725LF</b> 72" X 24" X 29" Cubic Ft: 35.7 Ship Weight: 189	<b>1083</b>	<b>1099</b>	<b>1115</b>
---	-------------	-------------	-------------

<b>Keyboard Platform K</b>	196	199	202
----------------------------	-----	-----	-----

<b>BP_625LF</b> 66" X 24" X 29" Cubic Ft: 32 Ship Weight: 184	<b>980</b>	<b>995</b>	<b>1009</b>
---	------------	------------	-------------

<b>Keyboard Platform K</b>	196	199	202
----------------------------	-----	-----	-----

<b>BP_725RF</b> 72" X 24" X 29" Cubic Ft: 35.7 Ship Weight: 189	<b>1083</b>	<b>1099</b>	<b>1115</b>
---	-------------	-------------	-------------

<b>Keyboard Platform K</b>	196	199	202
----------------------------	-----	-----	-----

<b>BP_625RF</b> 66" X 24" X 29" Cubic Ft: 32 Ship Weight: 184	<b>980</b>	<b>995</b>	<b>1009</b>
---	------------	------------	-------------

<b>Keyboard Platform K</b>	196	199	202
----------------------------	-----	-----	-----

**Pulls:** BLACK DRAWER PULL **P \$19**

# FINISH SELECTION

NATURAL MAPLE **FM** | MAHOGANY **M** | MEDIUM OAK **O** | GREY **G** | GUNSTOCK WALNUT **W** |

# SIN 711-2 BRAVO PANEL

Zone Pricing	1	2	3
--------------	---	---	---

### Left Lateral File Credenza

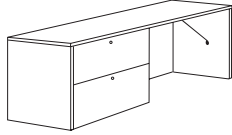

- Two lateral file drawers on left
- Pre-installed, black filing hardware
- Letter or legal filing
- Individually front locking drawers

Freight Class: 125

<b>BP_733L</b>	72" X 24" X 29"	Cubic Ft: 35.7	Ship Weight: 229	<b>1276</b>	<b>1295</b>	<b>1314</b>
<b>Pulls:</b>	BLACK DRAWER PULL <b>P \$19</b>	<b>EXTRA THICK BOTTOM</b>	\$160 <b>H</b>			

### Right Lateral File Credenza

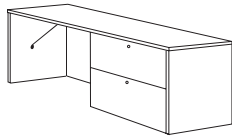

- Two lateral file drawers on right
- Pre-installed, black filing hardware
- Letter or legal filing
- Individually front locking drawers

Freight Class: 125

<b>BP_733R</b>	72" X 24" X 29"	Cubic Ft: 35.7	Ship Weight: 229	<b>1276</b>	<b>1295</b>	<b>1314</b>
<b>Pulls:</b>	BLACK DRAWER PULL <b>P \$19</b>	<b>EXTRA THICK BOTTOM</b>	\$160 <b>H</b>			

### Double Lateral File Credenza



- Four full-size lateral file drawers
- Pre-installed, black filing hardware
- Letter or legal filing
- Individually front locking drawers
- Pulls standard

Freight Class: 125

<b>BP_733</b>	72.5" X 24" X 29"	Cubic Ft: 35.7	Ship Weight: 299	<b>1522</b>	<b>1545</b>	<b>1568</b>
		<b>EXTRA THICK BOTTOM</b>	\$320 <b>H</b>			

### Left Lateral File/Bookcase Credenza



- Two full-size lateral file drawers on left
- Front locking file drawers
- Pre-installed, black filing hardware
- Letter or legal filing
- Bookcase with doors and adjustable shelf right
- Bookcase compartment dimensions 34" x 21" x 25"
- Pulls standard

Freight Class: 125

<b>BP_BK733L</b>	72.5" X 24" X 29"	Cubic Ft: 35.7	Ship Weight: 306	<b>1337</b>	<b>1357</b>	<b>1377</b>
		<b>EXTRA THICK BOTTOM</b>	\$160 <b>H</b>			

### Right Lateral File/Bookcase Credenza



- Two full-size lateral file drawers on right
- Front locking file drawers
- Pre-installed, black filing hardware
- Letter or legal filing
- Bookcase with doors and adjustable shelf left
- Bookcase compartment dimensions 34" x 21" x 25"
- Pulls standard

Freight Class: 125

<b>BP_BK733R</b>	72.5" X 24" X 29"	Cubic Ft: 35.7	Ship Weight: 306	<b>1337</b>	<b>1357</b>	<b>1377</b>
		<b>EXTRA THICK BOTTOM</b>	\$160 <b>H</b>			

### Double Bookcase Credenza

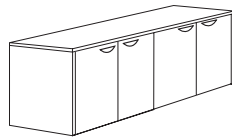

- Two bookcase compartments, each with adjustable shelf
- Doors conceal contents from view
- Bookcase compartment dimensions 34" x 21" x 25"
- Pulls standard

Freight Class: 125

<b>BP_734</b>	72.5" X 24" X 29"	Cubic Ft: 35.7	Ship Weight: 313	<b>1411</b>	<b>1432</b>	<b>1453</b>
---------------	-------------------	----------------	------------------	-------------	-------------	-------------

## Bridges

### Desk Height Bridge

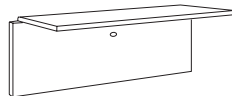

- One wire management grommet in modesty panel
- Assembly required

Freight Class: 100

<b>BP_485</b>	<b>QS</b>	48" X 24" X 29"	Cubic Ft: 4	Ship Weight: 66	<b>289</b>	<b>293</b>	<b>298</b>
<b>BP_484</b>		42" X 24" X 29"	Cubic Ft: 4	Ship Weight: 58	<b>262</b>	<b>266</b>	<b>270</b>
<b>BP_482</b>		36" X 24" X 29"	Cubic Ft: 4	Ship Weight: 48	<b>262</b>	<b>266</b>	<b>270</b>

**QS FINISHES** **M**

CONTEMPORARY LAMINATE



BP **FM** 662L  
Finish

Zone Pricing	1	2	3
--------------	---	---	---

### 3/4 Pedestal Machine Height Left Return

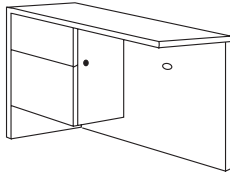

- One box drawer
- One file drawer
- Pre-installed filing hardware for letter or legal filing
- One wire management grommet in modesty panel
- Locking pedestal
- Use with single pedestal desks and credenzas

Freight Class: 110

<b>BP_662L QS</b>	42" X 24" X 26" Cubic Ft: 19.6 Ship Weight: 136	<b>686</b>	<b>696</b>	<b>707</b>
	<b>Keyboard Platform K</b>	196	199	202

**QS FINISHES M**

**Pulls:** BLACK DRAWER PULL **P \$19**

### 3/4 Pedestal Machine Height Right Return

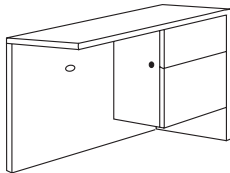

- One box drawer
- One file drawer
- Pre-installed filing hardware for letter or legal filing
- One wire management grommet in modesty panel
- Locking pedestal
- Use with single pedestal desks and credenzas

Freight Class: 110

<b>BP_662R QS</b>	42" X 24" X 26" Cubic Ft: 19.6 Ship Weight: 136	<b>686</b>	<b>696</b>	<b>707</b>
	<b>Keyboard Platform K</b>	196	199	202

**QS FINISHES M**

**Pulls:** BLACK DRAWER PULL **P \$19**

### 3/4 Pedestal Desk Height Left Return

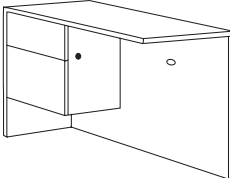

- One box drawer
- One file drawer, letter or legal filing
- One wire management grommet in modesty panel
- Locking pedestal
- Use with single pedestal desks and credenzas

Freight Class: 110

<b>BP_722L QS</b>	48" X 24" X 29" Cubic Ft: 24.3 Ship Weight: 154	<b>686</b>	<b>696</b>	<b>707</b>
	<b>Keyboard Platform K</b>	196	199	202

<b>BP_622L</b>	42" X 24" X 29" Cubic Ft: 21.5 Ship Weight: 140	<b>624</b>	<b>633</b>	<b>643</b>
	<b>Keyboard Platform K</b>	196	199	202

**QS FINISHES M**

**Pulls:** BLACK DRAWER PULL **P \$19**

### 3/4 Pedestal Desk Height Right Return

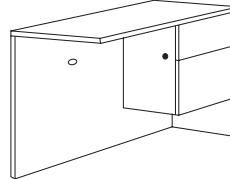

- One box drawer
- One file drawer, letter or legal filing
- One wire management grommet in modesty panel
- Locking pedestal
- Use with single pedestal desks and credenzas

Freight Class: 110

<b>BP_722R QS</b>	48" X 24" X 29" Cubic Ft: 24.3 Ship Weight: 154	<b>686</b>	<b>696</b>	<b>707</b>
	<b>Keyboard Platform K</b>	196	199	202

<b>BP_622R</b>	42" X 24" X 29" Cubic Ft: 21.5 Ship Weight: 140	<b>624</b>	<b>633</b>	<b>643</b>
	<b>Keyboard Platform K</b>	196	199	202

**QS FINISHES M**

**Pulls:** BLACK DRAWER PULL **P \$19**

### 3/4 Pedestal Compact Left Return

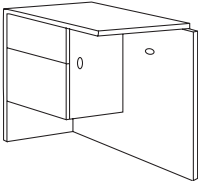

- One box drawer
- One file drawer, letter or legal filing
- Locking left pedestal
- One wire management grommet in modesty panel
- Keyboard tray not available for compact returns

Freight Class: 110

<b>BP_452L</b>	36" X 24" X 29" Cubic Ft: 19.6 Ship Weight: 129	<b>632</b>	<b>641</b>	<b>651</b>
----------------	---	------------	------------	------------

**Pulls:** BLACK DRAWER PULL **P \$19**

### 3/4 Pedestal Compact Right Return

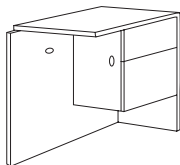

- One box drawer
- One file drawer, letter or legal filing
- Locking right pedestal
- One wire management grommet in modesty panel
- Keyboard tray not available for compact returns

Freight Class: 110

<b>BP_452R</b>	36" X 24" X 29" Cubic Ft: 19.6 Ship Weight: 129	<b>632</b>	<b>641</b>	<b>651</b>
----------------	---	------------	------------	------------

**Pulls:** BLACK DRAWER PULL **P \$19**

# FINISH SELECTION

NATURAL MAPLE **FM** | MAHOGANY **M** | MEDIUM OAK **O** | GREY **G** | GUNSTOCK WALNUT **W** |

# SIN 711-2 BRAVO PANEL

## Full File/File Return

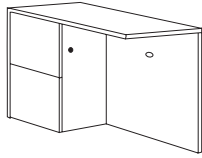

- Two file drawers
- Pre-installed filing hardware
- Letter or legal filing
- Locking pedestal
- One grommet in modesty panel
- Left pedestal shown (LF)

Freight Class: 110

## Full Box/Box/File Return

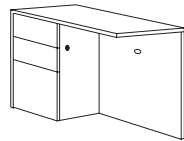

- Box/Box/File pedestal
- Pre-installed filing hardware
- Letter or legal filing
- Locking pedestal
- One grommet in modesty panel
- Left pedestal shown (L2BF)

Freight Class: 110

## Right Compact Return

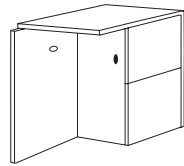

- File/file pedestal on right
- Pre-installed filing hardware for letter or legal filing
- One wire management grommet in modesty panel
- Locking pedestal
- Keyboard tray not available for compact returns

Freight Class: 110

## Left Compact Return

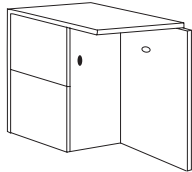

- File/file pedestal on left
- Pre-installed filing hardware for letter or legal filing
- One wire management grommet in modesty panel
- Locking pedestal
- Keyboard tray not available for compact returns

Freight Class: 110

## Overhead Storage & Screens

### Organizer

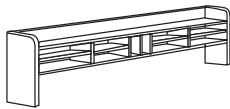

- Four adjustable shelves
- Two 16" wide compartments
- Two 9" wide compartments
- Two 3" wide compartments
- 4" gallery rail

Freight Class: 125

### Open Overhead Storage Unit

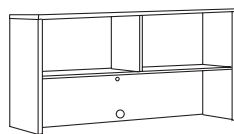

- Two open storage compartments
- 21" clearance under compartments
- One wire management grommet
- Includes full back panel
- Ships fully assembled
- Tack board available

Freight Class: 125

Zone Pricing	1	2	3
--------------	---	---	---

<b>BP_722LF</b> 48" X 24" X 29" Cubic Ft: 24.3 Ship Weight: 161	<b>893</b>	<b>906</b>	<b>920</b>
<b>Keyboard Platform K</b>	196	199	202
<b>BP_722RF</b> 48" X 24" X 29" Cubic Ft: 24.3 Ship Weight: 161	<b>893</b>	<b>906</b>	<b>920</b>
<b>Keyboard Platform K</b>	196	199	202
<b>BP_622LF</b> 42" X 24" X 29" Cubic Ft: 21.5 Ship Weight: 153	<b>829</b>	<b>841</b>	<b>854</b>
<b>Keyboard Platform K</b>	196	199	202
<b>BP_622RF</b> 42" X 24" X 29" Cubic Ft: 21.5 Ship Weight: 153	<b>829</b>	<b>841</b>	<b>854</b>
<b>Keyboard Platform K</b>	196	199	202

**Pulls:** BLACK DRAWER PULL **P \$19**

<b>BP_722L2BF</b> 48" X 24" X 29" Cubic Ft: 24.3 Ship Weight: 161	<b>893</b>	<b>906</b>	<b>920</b>
<b>Keyboard Platform K</b>	196	199	202
<b>BP_722R2BF</b> 48" X 24" X 29" Cubic Ft: 24.3 Ship Weight: 161	<b>893</b>	<b>906</b>	<b>920</b>
<b>Keyboard Platform K</b>	196	199	202

**Pulls:** BLACK DRAWER PULL **P \$19**

<b>BP_452RF</b> 36" X 24" X 29" Cubic Ft: 19.6 Ship Weight: 146	<b>821</b>	<b>833</b>	<b>846</b>
---	------------	------------	------------

**Pulls:** BLACK DRAWER PULL **P \$19**

<b>BP_452LF</b> 36" X 24" X 29" Cubic Ft: 19.6 Ship Weight: 146	<b>821</b>	<b>833</b>	<b>846</b>
---	------------	------------	------------

**Pulls:** BLACK DRAWER PULL **P \$19**

<b>BP_627</b> 62" X 13" X 29" Cubic Ft: 12.3 Ship Weight: 105	<b>919</b>	<b>933</b>	<b>947</b>
---	------------	------------	------------

<b>BP_617 QS</b> 64" X 17" X 36.5" Cubic Ft: 28.3 Ship Weight: 179	<b>793</b>	<b>805</b>	<b>817</b>
<b>Task Light I</b>	124	126	128
<b>LED Task Light L</b>	212	215	218

<b>BP_717</b> 70" X 17" X 36.5" Cubic Ft: 30.5 Ship Weight: 200	<b>827</b>	<b>839</b>	<b>852</b>
<b>Task Light I</b>	124	126	128
<b>LED Task Light L</b>	212	215	218

**QS FINISHES M**

CONTEMPORARY LAMINATE

# BRAVO PANEL SIN 711-2

Edge Profile



How to Order

BP **FM** 737  
Finish

CONTEMPORARY LAMINATE

Zone Pricing	1	2	3
--------------	---	---	---

### Open Overhead Storage Unit With Doors

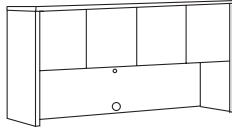

- Two open storage compartments behind four wood doors
- 21" clearance under storage area
- One wire management grommet in full back panel
- Ships fully assembled
- Tack board available

<b>BP_737 QS</b>	70" X 17" X 36.5" Cubic Ft: 30.5 Ship Weight: 220	<b>894</b>	<b>907</b>	<b>921</b>
	<b>Task Light I</b>	124	126	128
	<b>LED Task Light L</b>	212	215	218
<b>BP_677</b>	64" X 17" X 36.5" Cubic Ft: 28.3 Ship Weight: 199	<b>861</b>	<b>874</b>	<b>887</b>
	<b>Task Light I</b>	124	126	128
	<b>LED Task Light L</b>	212	215	218
<b>BP_675</b>	57.75" X 17" X 36.5" Cubic Ft: 28.3 Ship Weight: 180	<b>777</b>	<b>789</b>	<b>800</b>
	<b>Task Light I</b>	124	126	128
	<b>LED Task Light L</b>	212	215	218

Freight Class: 125

**QS FINISHES** **M**

**Pulls:** BLACK DRAWER PULL **P \$38**

**Locks** \$150: **Y**

### Overhead Storage Unit

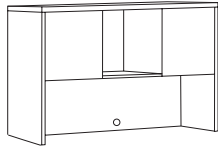

- Two storage compartments with doors
- Center open storage
- 21" monitor clearance under cabinet
- One grommet in back panel

<b>BP_477</b>	48" X 17" X 36.5" Cubic Ft: 24.3 Ship Weight: 163	<b>685</b>	<b>695</b>	<b>706</b>
	<b>Task Light I</b>	124	126	128
	<b>LED Task Light L</b>	212	215	218
	<b>Pulls:</b> BLACK DRAWER PULL <b>P \$19</b>		<b>Locks</b> \$150: <b>Y</b>	

Freight Class: 125

### Overhead Storage Unit

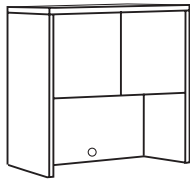

- Storage compartment
- Two doors
- 21" monitor clearance under cabinet
- One grommet in back panel

<b>BP_475</b>	42" X 17" X 36.5" Cubic Ft: 24.3 Ship Weight: 143	<b>613</b>	<b>622</b>	<b>631</b>
	<b>Task Light I</b>	124	126	128
	<b>LED Task Light L</b>	212	215	218
<b>BP_337</b>	36" X 17" X 36.5" Cubic Ft: 15.3 Ship Weight: 125	<b>582</b>	<b>591</b>	<b>599</b>
	<b>Task Light I</b>	124	126	128
	<b>LED Task Light L</b>	212	215	218
<b>BP_335</b>	30" X 17" X 36.5" Cubic Ft: 15.3 Ship Weight: 120	<b>551</b>	<b>559</b>	<b>568</b>
	<b>Task Light I</b>	124	126	128
	<b>LED Task Light L</b>	212	215	218
	<b>Pulls:</b> BLACK DRAWER PULL <b>P \$19</b>		<b>Locks</b> \$75: <b>Y</b>	

Freight Class: 125

### Bookcase Hutch

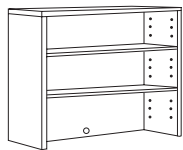

- Two adjustable 1" thick shelves
- One grommet in back panel
- Fits 36" lateral file or storage cabinet

<b>BP_319</b>	34.75" X 17" X 36.5" Cubic Ft: 15.3 Ship Weight: 125	<b>672</b>	<b>682</b>	<b>692</b>
---------------	--	------------	------------	------------

Freight Class: 125

### Reception Screen for Main



- Fits 72" x 30" desks
- Non-skid rubber strips on bottom prohibit movement

<b>BP_710</b>	69.75" X 30" X 14" Cubic Ft: 31.9 Ship Weight: 140	<b>632</b>	<b>641</b>	<b>651</b>
---------------	--	------------	------------	------------

Freight Class: 70

### Reception Screen for Return

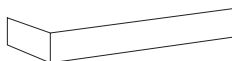

- Fits 42" x 24" executive height return
- Hardware included to join to main reception screen
- 611L fits left return
- 611R fits right return

<b>BP_611R</b>	42" X 24" X 13" Cubic Ft: 1.5 Ship Weight: 25	<b>182</b>	<b>185</b>	<b>187</b>
<b>BP_611L</b>	42" X 24" X 13" Cubic Ft: 1.5 Ship Weight: 25	<b>182</b>	<b>185</b>	<b>187</b>

Freight Class: 70



FINISH SELECTION

NATURAL MAPLE **FM** | MAHOGANY **M** | MEDIUM OAK **O** | GREY **G** | GUNSTOCK WALNUT **W** |

SIN 711-2 **BRAVO PANEL**

**File, Bookcase & Cabinets**

Zone Pricing	1	2	3
--------------	---	---	---

**Two-Door Storage Unit**

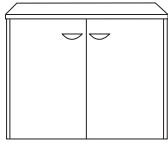

- Two hinged doors
- One adjustable shelf in storage area
- Leveling glides
- Pulls standard
- Inside dimensions 34" x 21" x 25"

Freight Class: 100

<b>BP_732</b>	36" X 24" X 29"	Cubic Ft: 19.8	Ship Weight: 133	<b>582</b>	<b>591</b>	<b>599</b>
---------------	-----------------	----------------	------------------	------------	------------	------------

**Standard Lateral File**

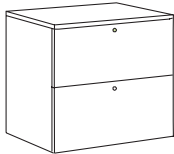

- Two lateral file drawers
- Pre-installed filing hardware for letter or legal filing
- Individually locking drawers
- Anit-tilt mechanism inhibits more than one drawer opening at a time
- Hardwood bottom support rail secured with metal bracket at each end

Freight Class: 100

<b>BP_326 QS</b>	30.75" X 20" X 29"	Cubic Ft: 14	Ship Weight: 140	<b>725</b>	<b>736</b>	<b>747</b>
------------------	--------------------	--------------	------------------	------------	------------	------------

**Pulls:** BLACK DRAWER PULL **P \$19**

**EXTRA THICK BOTTOM** \$160 **H**

**QS FINISHES** **M**

**Executive Lateral File**

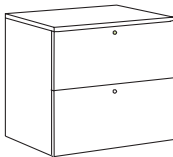

- Two lateral file drawers
- Pre-installed filing hardware for letter or legal filing
- Individually locking drawers
- Hardwood bottom support rail secured with metal bracket at each end
- Anit-tilt counter weight

Freight Class: 100

<b>BP_346 QS</b>	36" X 24" X 29"	Cubic Ft: 18.8	Ship Weight: 197	<b>780</b>	<b>792</b>	<b>803</b>
------------------	-----------------	----------------	------------------	------------	------------	------------

**Pulls:** BLACK DRAWER PULL **P \$19**

**EXTRA THICK BOTTOM** \$160 **H**

**QS FINISHES** **M**

**Four Drawer Lateral File**

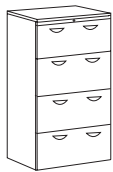

- Four lateral file drawers
- Pre-installed filing hardware for letter or legal filing
- Central locking
- Anit-tilt mechanism inhibits more than one drawer opening at a time
- Hardwood bottom support rail secured with metal bracket at each end
- Pulls standard

Freight Class: 100

<b>BP_426</b>	30.75" X 20" X 56"	Cubic Ft: 27.9	Ship Weight: 252	<b>1799</b>	<b>1826</b>	<b>1853</b>
---------------	--------------------	----------------	------------------	-------------	-------------	-------------

**EXTRA THICK BOTTOM** \$320 **H**

**Mobile Box/Box/File Pedestal**



- Fits under work surfaces
- Box/Box/File drawers
- Pre-installed filing hardware for letter or legal filing
- Front locking
- Four casters, two locking
- Pulls standard

Freight Class: 100

<b>BP_21</b>	16" X 22" X 27.75"	Cubic Ft: 10.3	Ship Weight: 105	<b>639</b>	<b>649</b>	<b>658</b>
--------------	--------------------	----------------	------------------	------------	------------	------------

**Mobile File/File Pedestal**



- Fits under work surfaces
- Two file drawers
- Pre-installed, black filing hardware
- Letter or legal filing
- Front locking
- Four casters, two locking
- Pulls standard

Freight Class: 100

<b>BP_21F</b>	16" X 22" X 27.75"	Cubic Ft: 10.3	Ship Weight: 93	<b>639</b>	<b>649</b>	<b>658</b>
---------------	--------------------	----------------	-----------------	------------	------------	------------

**MultiUse Wardrobe/Storage**

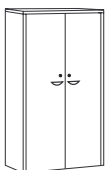

- Coat rod mounted side-to-side left side
- Four adjustable shelves on right
- Both sides drilled for adjustable shelves
- 3/4" thick shelves
- Individually locking doors
- Pulls standard

Freight Class: 125

<b>BP_65DWD</b>	36" X 24" X 65.5"	Cubic Ft: 43.1	Ship Weight: 300	<b>1717</b>	<b>1743</b>	<b>1769</b>
-----------------	-------------------	----------------	------------------	-------------	-------------	-------------

CONTEMPORARY LAMINATE



BP FM 65STOR  
Finish

### Storage Cabinet

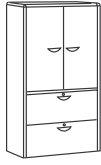

Freight Class: 125

- Storage compartment 34" x 19-5/8" x 34"
- Two adjustable shelves in storage compartment
- Two lateral file drawers, legal or letter filing
- Single-key, front-locking file cabinet
- Hardwood bottom support rail secured with metal bracket at each end
- Pulls standard

<b>BP_65STOR</b> 36" X 24" X 65.5" Cubic Ft: 40.3 Ship Weight: 300	<b>1717</b>	<b>1743</b>	<b>1769</b>
--	-------------	-------------	-------------

**EXTRA THICK BOTTOM** \$160 [H](#)

### Wardrobe



Freight Class: 125

- Coat rod mounted side-to-side
- Adjustable shelf near bottom
- Pulls standard
- BP\_65WDR - Door hinge on right
- BP\_65WDL - Door hinge on left (shown)

<b>BP_65WDR</b> 24" X 24" X 65.5" Cubic Ft: 31.6 Ship Weight: 200	<b>1156</b>	<b>1173</b>	<b>1191</b>
---	-------------	-------------	-------------

<b>BP_65WDL</b> 24" X 24" X 65.5" Cubic Ft: 31.6 Ship Weight: 200	<b>1156</b>	<b>1173</b>	<b>1191</b>
---	-------------	-------------	-------------

### Wardrobe/Storage Cabinet

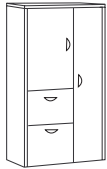

Freight Class: 125

- Coat rod mounted in wardrobe side
- Storage cabinet above drawers with one adjustable shelf
- All shelves are 3/4" thick
- Pulls standard
- BP\_65TL - Drawers on left (shown)
- BP\_65RR - Drawers on right

<b>BP_65TR</b> 24" X 24" X 65" Cubic Ft: 31.6 Ship Weight: 218	<b>1594</b>	<b>1618</b>	<b>1642</b>
--	-------------	-------------	-------------

<b>BP_65TL</b> 24" X 24" X 65" Cubic Ft: 31.6 Ship Weight: 218	<b>1594</b>	<b>1618</b>	<b>1642</b>
--	-------------	-------------	-------------

### Curved Corner Bookcase, 65.5" High

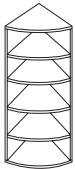

Freight Class: 125

- Fits in corner at end of workstation
- Five shelf storage
- Four adjustable shelves
- Bottom shelf fixed
- All shelves are 3/4" thick

<b>BP_CB65</b> 24" X 24" X 65.5" Cubic Ft: 31.6 Ship Weight: 182	<b>845</b>	<b>858</b>	<b>870</b>
--	------------	------------	------------

### Curved Corner Bookcase, 29" High

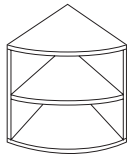

Freight Class: 125

- Fits in corner at end of workstation
- Middle shelf adjustable
- All shelves are 3/4" thick

<b>BP_CB29</b> 24" X 24" X 29" Cubic Ft: 19.4 Ship Weight: 115	<b>569</b>	<b>578</b>	<b>586</b>
--	------------	------------	------------

## Center Drawers

### Center Drawer

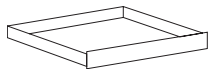

Freight Class: 100

- CD\_18 Fits 60" and 66" single pedestal desks
- CD\_19 Fits 60" double pedestal and 72" and 48" single pedestal desks
- CD\_32 Fits 66" double pedestal desks
- CD\_30 Fits 72" pedestal desks

<b>CD_18 QS</b> 20" X 18" X 3" Cubic Ft: 1.5 Ship Weight: 11	<b>160</b>	<b>162</b>	<b>165</b>
--	------------	------------	------------

<b>CD_19 QS</b> 26" X 18" X 3" Cubic Ft: 1.5 Ship Weight: 12	<b>160</b>	<b>162</b>	<b>165</b>
--	------------	------------	------------

<b>CD_32 QS</b> 32" X 18" X 3" Cubic Ft: 2.2 Ship Weight: 13	<b>172</b>	<b>175</b>	<b>177</b>
--	------------	------------	------------

<b>CD_30 QS</b> 38" X 18" X 3" Cubic Ft: 2.2 Ship Weight: 13	<b>172</b>	<b>175</b>	<b>177</b>
--	------------	------------	------------

Use with 2200 Series and Bravo Panel

**FINISHES**

Bedford is available in **Mahogany** and **Windsor Cherry** laminate.

**PEDESTALS, CREDENZAS, FILE CABINETS AND STORAGE UNITS**

All cases are  $\frac{3}{4}$ " thick core surfaced on both sides with thermally fused laminate and edge banded as required. Units fully assembled with dowels/glue, wood cleats, metal brackets and screws. This series features picture frame molding on ends, backs and modesty panels. No molding on bridge. Series features full modesty panels.

**TOPS**

All tops are surfaced in **high-gloss, high pressure laminate** specifically chosen and color matched for this grouping. All bridge and return tops feature common grain direction with desk/credenza as well as reverse coped edges for smooth worksurface connection with desk/credenza. All tops are  $1\frac{3}{16}$ " thick with solid hardwood edges and properly backed. All tops feature traditional detail on hardwood edges on all four sides. Work surface dimensions will vary due to edge profile treatments.

**DRAWERS**

All drawer fronts are constructed of  $\frac{3}{4}$ " thick core surfaced on both sides with melamine and edge banded as required. Drawer sides are  $\frac{1}{2}$ " thick, grain printed in an oak finish. Drawer bottoms are  $\frac{1}{8}$ " thick oak-grain hardboard.

- All box drawers are suspended on smooth action metal slides with ball bearings
- All file drawers and file cabinet drawers are mounted on heavy-duty ball bearing, full-extension slides
- Black filing hardware includes pre-installed rails with easy-adjust crossbar
- All file drawers allow letter filing front-to-back and letter or legal-size filing side-to-side
- All 38" lateral file drawers allow letter and/or legal filing front-to-back or legal size filing side-to-side
- 32" lateral file drawers allow legal filing side-to-side and letter filing front-to-back
- Maximum weight for bottom loading is 25 lb
- Drawers are constructed with 5 sides for extra strength and durability. The drawer front is the 5th side and is removable in the field for repairs or hardware additions

**PEDESTALS**

Supported on 4 leveling glides.

**PANELS**

Heavy-duty adjustable nylon leveling glides installed in each end panel. Modesty panels are  $\frac{3}{4}$ " thick core.

**TACK BOARDS**

Fabric covered tackable boards may be ordered separately to fit inside hutches. They can be ordered with any fabric to match your office chairs except leather or vinyl.

**BASES**

All bases are 1" thick MDF surfaced with laminate.

**GROMMETS**

All grommets in the Bedford collection are rectangular and made of black high impact poly resin. See features for number of grommets and location. Additional grommets can be added for extended wire management capability at \$106 list per grommet. Includes factory cut and installed grommet and black sleeve. Call for special quote. Specify location and quote number with order.

**HARDWARE**

Pulls and knobs are a beautiful traditional design, solid metal antique brass finish.

**LOCKS**

- Independent fully locking pedestals are standard on all credenzas and desks.
- Two drawer lateral files feature individually locking drawers.
- Four drawer lateral files feature central locking and are keyed different than other locks due to the anti-tilt mechanism inside the unit.
- All locks are keyed identical unless otherwise specified.
- 'Key Different' option is \$21 list upcharge per lock. Locks/cores packaged to customer requirements.
- Additional lead time for 'Key Different' For optional locking on overhead storage units with four wood doors, add **Y** to the end of the model number and add \$150 to the list price of unit.

**ACCESSORIES** *Factory Installed*

Certain accessories can be ordered installed prior to shipment. Add letter designator (C, K or T) at end of the desk, credenza or overhead model number:

- C** Center Drawer  
*Example: TRM3030C*
- K** Keyboard Platform  
*Example: TRM3076LK*
- T** Task Light  
*Example: TRM3071T*

**DIMENSIONS**

All size dimensions are nominal and subject to change. If you must have exact dimensions, please contact your Customer Service Representative. Worksurface dimensions will vary due to edge profile treatment. Always measure actual top before ordering glass or other cover to fit tops.

**QUICKSHIP**

Quick Ship is not available on any items ordered with option.

**PACKING**

All units are properly packed in heavy duty cartons with heavy duty corner pads. All packaging conforms to or exceeds specifications as outlined in the Uniform Freight Classification.

All desks, credenzas, files, and overhead storage units are shipped assembled. Modular L-shaped, and U-shaped workstations are shipped in multiple cartons & require connection.

**PALLETIZATION**

See page 3.

**CARE & CLEANING INSTRUCTIONS**

Normal cleaning: Clean using a soft cloth and a good window cleaner which contains no ammonia, followed by wiping dry using a dry soft cloth.

**Specifications subject to change without notice.**



## Configurations

Zone Pricing	1	2	3
--------------	---	---	---

### L-Shaped Workstation



Description	Model Number	Qty	Frft. Class	Cubic Ft.	Ship Weight			
Left Pedestal Desk	TR_3045ALH 66" x 30" x 29"	1	110	40.2	267	<b>2051</b>	<b>2082</b>	<b>2113</b>
Desk Height Right Return	TR_3048BRH 48" x 24" x 29"	1	110	25.3	178	<b>1529</b>	<b>1552</b>	<b>1575</b>
Total:						<b>3580</b>	<b>3634</b>	<b>3688</b>

66" x 78" x 29"

### U-Shaped Workstation

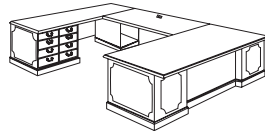

Description	Model Number	Qty	Frft. Class	Cubic Ft.	Ship Weight			
Right Pedestal Desk	TR_3048ARH 72" x 36" x 29"	1	110	51.6	308	<b>2484</b>	<b>2521</b>	<b>2559</b>
Desk Height Bridge	TR_3041 48" x 24" x 29"	1	100	4.0	89	<b>654</b>	<b>664</b>	<b>674</b>
Left Twin Pedestal Credenza	TR_3075L 72" x 24" x 29"	1	125	35.7	277	<b>2173</b>	<b>2206</b>	<b>2238</b>
Total:						<b>5311</b>	<b>5391</b>	<b>5471</b>

72" x 108" x 29"

### U-Shaped Workstation

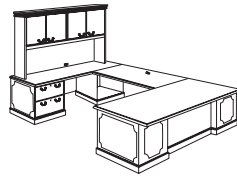

Description	Model Number	Qty	Frft. Class	Cubic Ft.	Ship Weight			
Right Pedestal Desk	TR_3048ARH 72" x 36" x 29"	1	110	51.6	308	<b>2484</b>	<b>2521</b>	<b>2559</b>
Desk Height Bridge	TR_3041 48" x 24" x 29"	1	100	4.0	89	<b>654</b>	<b>664</b>	<b>674</b>
Left Lateral File Credenza	TR_3033L 72" x 24" x 29"	1	125	35.7	254	<b>2145</b>	<b>2177</b>	<b>2209</b>
Overhead Storage Unit	TR_3071 72" x 16" x 48"	1	125	43.6	261	<b>1675</b>	<b>1700</b>	<b>1725</b>
Total:						<b>6958</b>	<b>7062</b>	<b>7167</b>

72" x 108" x 77"

## Desks

### Double Pedestal Bow Front Desk



- Pencil/box/file drawer configuration
- Legal or letter filing
- Two pullout writing shelves
- Individually locking pedestals

Freight Class: 110

<b>TR_3030B QS</b>	72" X 36" X 29" Cubic Ft: 51.6 Ship Weight: 333	<b>2594</b>	<b>2633</b>	<b>2672</b>
--------------------	---	-------------	-------------	-------------

<b>Center Drawer C</b>	176	179	181
<b>Keyboard Platform K</b>	193	196	199

**QS FINISHES M**

### Left Pedestal Bow Front Desk



- Pencil/box/file drawer configuration
- Legal or letter filing
- One pullout writing shelf
- Locking pedestal
- Center drawer standard
- Extra open storage pedestal on connecting side

Freight Class: 110

<b>TR_30721LB</b>	72" X 36" X 29" Cubic Ft: 51.6 Ship Weight: 296	<b>2640</b>	<b>2680</b>	<b>2719</b>
-------------------	---	-------------	-------------	-------------

### Right Pedestal Bow Front Desk



- Pencil/box/file drawer configuration
- Legal or letter filing
- One pullout writing shelf
- Locking pedestal
- Center drawer standard
- Extra open storage pedestal on connecting side

Freight Class: 110

<b>TR_30721RB</b>	72" X 36" X 29" Cubic Ft: 51.6 Ship Weight: 296	<b>2640</b>	<b>2680</b>	<b>2719</b>
-------------------	---	-------------	-------------	-------------

TRADITIONAL LAMINATE

**Double Pedestal Desk**



- Two pencil drawers
- Two box drawers
- Two file drawers
- Pre-installed filing hardware for letter or legal filing
- Two pullout writing shelves
- Individually locking pedestals

Freight Class: 110

**Left Pedestal Desk**



- Pencil/box/file pedestal on left
- Pre-installed filing hardware for letter or legal filing
- One pullout writing shelf
- Locking pedestal
- Center drawer standard
- Extra open storage pedestal on connecting side

Freight Class: 110

**Right Pedestal Desk**



- Pencil/box/file pedestal on right
- Pre-installed filing hardware for letter or legal filing
- One pullout writing shelf
- Locking pedestal
- Center drawer standard
- Extra open storage pedestal on connecting side

Freight Class: 110

**Credenzas**

**Executive Storage Credenza**



- Two pencil/box/file drawer pedestals
- Pre-installed filing hardware for letter or legal filing
- Individually locking pedestals
- Storage compartment with one adjustable shelf behind two hinged doors, center

Freight Class: 125

**Computer Credenza**



- Two pencil/box/file drawer pedestals
- Pre-installed filing hardware for letter or legal filing
- Individually locking pedestals
- Pullout keyboard platform standard on TR\_3064
- Keyboard drawer with flip down front standard on TR\_3074
- One grommet in modesty panel

Freight Class: 110

**Right Computer Credenza**

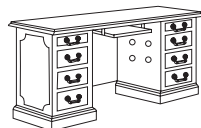

- CPU storage right pedestal
- Pencil/box/file drawer left pedestal
- Pre-installed filing hardware for letter or legal filing
- One grommet in back and four in inside panel of CPU storage pedestal
- Pullout keyboard platform standard
- Locking pedestal with drawers

Freight Class: 110

Zone Pricing	1	2	3
--------------	---	---	---

<b>TR_3020 QS</b>	60" X 30" X 29" Cubic Ft: 36.7 Ship Weight: 300	<b>2244</b>	<b>2278</b>	<b>2311</b>
	<b>Center Drawer C</b>	162	164	167
	<b>Keyboard Platform K</b>	193	196	199
<b>TR_3025 QS</b>	66" X 30" X 29" Cubic Ft: 40.2 Ship Weight: 326	<b>2403</b>	<b>2439</b>	<b>2475</b>
	<b>Center Drawer C</b>	176	179	181
	<b>Keyboard Platform K</b>	193	196	199
<b>TR_3030 QS</b>	72" X 36" X 29" Cubic Ft: 51.6 Ship Weight: 346	<b>2466</b>	<b>2503</b>	<b>2540</b>
	<b>Center Drawer C</b>	176	179	181
	<b>Keyboard Platform K</b>	193	196	199
<b>QS FINISHES M</b>				

<b>TR_3045ALH QS</b>	66" X 30" X 29" Cubic Ft: 40.2 Ship Weight: 267	<b>2051</b>	<b>2082</b>	<b>2113</b>
<b>TR_3048ALH QS</b>	72" X 36" X 29" Cubic Ft: 51.6 Ship Weight: 308	<b>2484</b>	<b>2521</b>	<b>2559</b>
<b>QS FINISHES M</b>				

<b>TR_3045ARH QS</b>	66" X 30" X 29" Cubic Ft: 40.2 Ship Weight: 267	<b>2051</b>	<b>2082</b>	<b>2113</b>
<b>TR_3048ARH QS</b>	72" X 36" X 29" Cubic Ft: 51.6 Ship Weight: 308	<b>2484</b>	<b>2521</b>	<b>2559</b>
<b>QS FINISHES M</b>				

<b>TR_3072 QS</b>	72" X 24" X 29" Cubic Ft: 35.7 Ship Weight: 316	<b>2540</b>	<b>2578</b>	<b>2616</b>
<b>QS FINISHES M</b>				

<b>TR_3064 QS</b>	66" X 24" X 29" Cubic Ft: 32.8 Ship Weight: 268	<b>2321</b>	<b>2356</b>	<b>2391</b>
<b>TR_3074 QS</b>	72" X 24" X 29" Cubic Ft: 35.7 Ship Weight: 302	<b>2353</b>	<b>2388</b>	<b>2424</b>
<b>QS FINISHES M</b>				

<b>TR_CPR744</b>	72" X 24" X 29" Cubic Ft: 35.7 Ship Weight: 287	<b>2353</b>	<b>2388</b>	<b>2424</b>
------------------	---	-------------	-------------	-------------

TRADITIONAL LAMINATE



Zone Pricing	1	2	3
--------------	---	---	---

### Left Computer Credenza

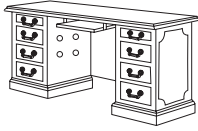

- CPU storage left pedestal
- Pencil/box/file drawer right pedestal
- Pre-installed filing hardware for letter or legal filing
- One grommet in back and four in inside panel of CPU storage pedestal
- Pullout keyboard platform standard
- Locking pedestal with drawers

Freight Class: 110

<b>TR_CPL744</b>	72" X 24" X 29" Cubic Ft: 35.7 Ship Weight: 287	<b>2353</b>	<b>2388</b>	<b>2424</b>
------------------	---	-------------	-------------	-------------

### Left Pedestal Credenza

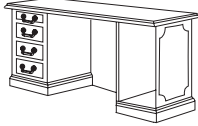

- Two file drawers
- Pre-installed filing hardware for letter or legal filing
- Single key side locking
- One grommet in modesty panel
- Extra open storage pedestal on connecting side

Freight Class: 125

<b>TR_3076L QS</b>	72" X 24" X 29" Cubic Ft: 35.7 Ship Weight: 200	<b>1846</b>	<b>1874</b>	<b>1901</b>
--------------------	---	-------------	-------------	-------------

<b>Keyboard Platform K</b>	193	196	199
----------------------------	-----	-----	-----

<b>TR_3064L</b>	66" X 24" X 29" Cubic Ft: 32.8 Ship Weight: 182	<b>1574</b>	<b>1598</b>	<b>1621</b>
-----------------	---	-------------	-------------	-------------

<b>Keyboard Platform K</b>	193	196	199
----------------------------	-----	-----	-----

**QS FINISHES** **M**

### Right Pedestal Credenza

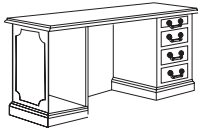

- Two file drawers
- Pre-installed filing hardware for letter or legal filing
- Single key side locking
- One grommet in modesty panel
- Extra open storage pedestal on connecting side

Freight Class: 125

<b>TR_3076R QS</b>	72" X 24" X 29" Cubic Ft: 35.7 Ship Weight: 200	<b>1846</b>	<b>1874</b>	<b>1901</b>
--------------------	---	-------------	-------------	-------------

<b>Keyboard Platform K</b>	193	196	199
----------------------------	-----	-----	-----

<b>TR_3064R</b>	66" X 24" X 29" Cubic Ft: 32.8 Ship Weight: 182	<b>1574</b>	<b>1598</b>	<b>1621</b>
-----------------	---	-------------	-------------	-------------

<b>Keyboard Platform K</b>	193	196	199
----------------------------	-----	-----	-----

**QS FINISHES** **M**

### Storage Credenza

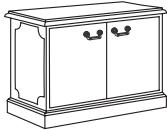

- Two hinged doors
- Storage compartment with one adjustable shelf

Freight Class: 125

<b>TR_3042 QS</b>	38" X 24" X 29" Cubic Ft: 19.5 Ship Weight: 140	<b>1171</b>	<b>1189</b>	<b>1206</b>
-------------------	---	-------------	-------------	-------------

**QS FINISHES** **M**

### Left Twin Pedestal Credenza



- Two pencil drawers
- Two box drawers
- Two file drawers
- Pre-installed filing hardware for letter or legal filing
- Lock on inside pedestal only
- One grommet in modesty panel
- Extra open storage pedestal on connecting side

Freight Class: 125

<b>TR_3075L QS</b>	72" X 24" X 29" Cubic Ft: 35.7 Ship Weight: 277	<b>2173</b>	<b>2206</b>	<b>2238</b>
--------------------	---	-------------	-------------	-------------

**QS FINISHES** **M**

### Right Twin Pedestal Credenza



- Two pencil drawers
- Two box drawers
- Two file drawers
- Pre-installed filing hardware for letter or legal filing
- Lock on inside pedestal only
- One grommet in modesty panel
- Extra open storage pedestal on connecting side

Freight Class: 125

<b>TR_3075R QS</b>	72" X 24" X 29" Cubic Ft: 35.7 Ship Weight: 277	<b>2173</b>	<b>2206</b>	<b>2238</b>
--------------------	---	-------------	-------------	-------------

**QS FINISHES** **M**

### Left Lateral File Credenza



- Two lateral file drawers
- Pre-installed filing hardware for letter or legal filing
- Side locking
- Extra open storage pedestal on connecting side

Freight Class: 125

<b>TR_3033L</b>	72" X 24" X 29" Cubic Ft: 35.7 Ship Weight: 254	<b>2145</b>	<b>2177</b>	<b>2209</b>
-----------------	---	-------------	-------------	-------------

**EXTRA THICK BOTTOM** \$160 **H**



Zone Pricing	1	2	3
--------------	---	---	---

**Right Lateral File Credenza**



- Two lateral file drawers
- Pre-installed filing hardware for letter or legal filing
- Side locking
- Extra open storage pedestal on connecting side

Freight Class: 125

<b>TR_3033R</b>	72" X 24" X 29" Cubic Ft: 35.7 Ship Weight: 254	<b>2145</b>	<b>2177</b>	<b>2209</b>
-----------------	---	-------------	-------------	-------------

<b>EXTRA THICK BOTTOM</b>	\$160 <b>H</b>
---------------------------	----------------

**Double Lateral File Credenza**



- Four lateral file drawers
- Pre-installed filing hardware for letter or legal filing
- Side locking

Freight Class: 125

<b>TR_733</b>	73.75" X 24" X 29" Cubic Ft: 35.7 Ship Weight: 368	<b>2914</b>	<b>2958</b>	<b>3001</b>
---------------	--	-------------	-------------	-------------

<b>EXTRA THICK BOTTOM</b>	\$320 <b>H</b>
---------------------------	----------------

**Double Lateral File Credenza**



- Two bookcase compartments
- One adjustable shelf in each compartment

Freight Class: 125

<b>TR_734</b>	72" X 24" X 29" Cubic Ft: 35.7 Ship Weight: 340	<b>2098</b>	<b>2129</b>	<b>2161</b>
---------------	---	-------------	-------------	-------------

**Returns & Bridges**

**Left Desk Height Return**



- One pencil/box/file drawer pedestal
- Pre-installed filing hardware for letter or legal filing
- One grommet in modesty panel
- Reverse coped edge for smooth connection
- Common grain direction with desk/credenzas

Freight Class: 110

<b>TR_3048BLH QS</b>	48" X 24" X 29" Cubic Ft: 25.3 Ship Weight: 178	<b>1529</b>	<b>1552</b>	<b>1575</b>
----------------------	---	-------------	-------------	-------------

<b>Keyboard Platform K</b>	193	196	199
----------------------------	-----	-----	-----

<b>TR_3040BLH</b>	42" X 24" X 29" Cubic Ft: 21.8 Ship Weight: 158	<b>1515</b>	<b>1538</b>	<b>1560</b>
-------------------	---	-------------	-------------	-------------

<b>Keyboard Platform K</b>	193	196	199
----------------------------	-----	-----	-----

<b>TR_3452L</b>	36" X 24" X 29" Cubic Ft: 21.8 Ship Weight: 138	<b>1512</b>	<b>1535</b>	<b>1557</b>
-----------------	---	-------------	-------------	-------------

<b>QS FINISHES</b>	<b>M</b>
--------------------	----------

**Right Desk Height Return**



- One pencil/box/file drawer pedestal
- Pre-installed filing hardware for letter or legal filing
- One grommet in modesty panel
- Reverse coped edge for smooth connection
- Common grain direction with desk/credenzas

Freight Class: 110

<b>TR_3048BRH QS</b>	48" X 24" X 29" Cubic Ft: 25.3 Ship Weight: 178	<b>1529</b>	<b>1552</b>	<b>1575</b>
----------------------	---	-------------	-------------	-------------

<b>Keyboard Platform K</b>	193	196	199
----------------------------	-----	-----	-----

<b>TR_3040BRH</b>	42" X 24" X 29" Cubic Ft: 21.8 Ship Weight: 158	<b>1515</b>	<b>1538</b>	<b>1560</b>
-------------------	---	-------------	-------------	-------------

<b>Keyboard Platform K</b>	193	196	199
----------------------------	-----	-----	-----

<b>TR_3452R</b>	36" X 24" X 29" Cubic Ft: 21.8 Ship Weight: 138	<b>1512</b>	<b>1535</b>	<b>1557</b>
-----------------	---	-------------	-------------	-------------

<b>QS FINISHES</b>	<b>M</b>
--------------------	----------

**Desk Height Bridge**

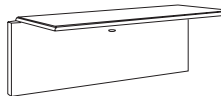

- Use with single pedestal desks and/or credenzas
- Common grain direction with desks/credenzas
- Reverse coped edge on connecting sides
- One wire management grommet in modesty panel

Freight Class: 100

<b>TR_3041 QS</b>	48" X 24" X 29" Cubic Ft: 4 Ship Weight: 89	<b>654</b>	<b>664</b>	<b>674</b>
-------------------	---	------------	------------	------------

<b>TR_3040 QS</b>	42" X 24" X 29" Cubic Ft: 4 Ship Weight: 80	<b>610</b>	<b>619</b>	<b>628</b>
-------------------	---	------------	------------	------------

<b>QS FINISHES</b>	<b>M</b>
--------------------	----------

**Files, Overheads, Bookcases & Storage**

**Two Drawer File**



- Two file drawers
- Pre-installed filing hardware for letter or legal filing
- Side locking

Freight Class: 100

<b>TR_302DF QS</b>	18" X 24" X 29" Cubic Ft: 10 Ship Weight: 111	<b>1164</b>	<b>1181</b>	<b>1199</b>
--------------------	---	-------------	-------------	-------------

<b>QS FINISHES</b>	<b>M</b>
--------------------	----------

TRADITIONAL LAMINATE



TR <b>M</b> 3026DF
Finish

Zone Pricing	1	2	3
--------------	---	---	---

### Standard Lateral File



Freight Class: 100

- Two lateral file drawers
- Pre-installed filing hardware for letter or legal filing
- Side locking
- Anti-tilt mechanism inhibits more than one drawer opening at one time

<b>TR_3026DF QS</b>	32" X 21.5" X 29" Cubic Ft: 14 Ship Weight: 152	<b>1265</b>	<b>1284</b>	<b>1303</b>
---------------------	---	-------------	-------------	-------------

**QS FINISHES** **M**

**EXTRA THICK BOTTOM** \$160 **H**

### Executive Lateral File



Freight Class: 100

- Two lateral file drawers
- Pre-installed filing hardware for letter or legal filing
- Side locking
- Anti-tilt mechanism inhibits more than one drawer opening at one time

<b>TR_3032DF QS</b>	38" X 24" X 29" Cubic Ft: 19.5 Ship Weight: 183	<b>1520</b>	<b>1543</b>	<b>1566</b>
---------------------	---	-------------	-------------	-------------

**QS FINISHES** **M**

**EXTRA THICK BOTTOM** \$160 **H**

### Three Drawer Lateral File



Freight Class: 125

- Three lateral file drawers
- Pre-installed filing hardware for letter or legal filing
- Central locking
- Anti-tilt mechanism inhibits more than one drawer opening at one time

<b>TR_3036DF QS</b>	32" X 21" X 44.5" Cubic Ft: 27.9 Ship Weight: 219	<b>2076</b>	<b>2107</b>	<b>2138</b>
---------------------	---	-------------	-------------	-------------

**QS FINISHES** **M**

**EXTRA THICK BOTTOM** \$240 **H**

### Four Drawer Lateral File



Freight Class: 125

- Four lateral file drawers
- Pre-installed filing hardware for letter or legal filing
- Central locking
- Anti-tilt mechanism inhibits more than one drawer opening at one time

<b>TR_4026DF QS</b>	32" X 21" X 56" Cubic Ft: 27.9 Ship Weight: 252	<b>2471</b>	<b>2508</b>	<b>2545</b>
---------------------	---	-------------	-------------	-------------

**QS FINISHES** **M**

**EXTRA THICK BOTTOM** \$320 **H**

### Single Hutch



Freight Class: 125

- Three adjustable shelves
- One wire management grommet in back panel
- Fits 38" wide executive lateral file (TR\_3032DF)

<b>TR_3066 QS</b>	36" X 16" X 48" Cubic Ft: 22.9 Ship Weight: 108	<b>830</b>	<b>842</b>	<b>855</b>
-------------------	---	------------	------------	------------

**QS FINISHES** **M**

### Double Hutch



Freight Class: 125

- Six adjustable shelves
- Two wire management grommets in back panel
- Fits 72" wide credenzas

<b>TR_3068 QS</b>	72" X 16" X 48" Cubic Ft: 43.6 Ship Weight: 207	<b>1624</b>	<b>1648</b>	<b>1673</b>
-------------------	---	-------------	-------------	-------------

**QS FINISHES** **M**

### Overhead Storage Unit

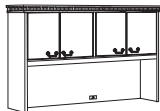

Freight Class: 125

- Two storage compartments
- One wire management grommet in back panel
- 25-1/4" clearance under doors
- Fits 72" wide credenzas
- Tackboard available

<b>TR_3071 QS</b>	72" X 16" X 48" Cubic Ft: 43.6 Ship Weight: 261	<b>1675</b>	<b>1700</b>	<b>1725</b>
-------------------	---	-------------	-------------	-------------

**QS FINISHES** **M**

**Task Light T** 124 126 128

**LED Task Light L** 212 215 218

<b>TR_3077</b>	66" X 16" X 48" Cubic Ft: 43.6 Ship Weight: 245	<b>1447</b>	<b>1469</b>	<b>1490</b>
----------------	---	-------------	-------------	-------------

**Locks** \$150: **Y**

**Task Light T** 124 126 128

**LED Task Light L** 212 215 218

### Two-Shelf Bookcase



Freight Class: 125

- One adjustable and one fixed shelf
- 1" thick shelf
- Crown molding on three sides

<b>TR_B36</b>	36" X 16" X 36" Cubic Ft: 15.4 Ship Weight: 91	<b>716</b>	<b>727</b>	<b>737</b>
---------------	--	------------	------------	------------

Zone Pricing	1	2	3
--------------	---	---	---

**Bookcase Storage with Two Doors**



- One adjustable shelf
- 1" thick shelf
- Two doors
- Crown molding on three sides

Freight Class: 125

<b>TR_362D</b>	36" X 16" X 36" Cubic Ft: 15.4 Ship Weight: 125	<b>891</b>	<b>904</b>	<b>918</b>
----------------	---	------------	------------	------------

**Three Shelf Bookcase**



- Two adjustable shelves
- 1" thick shelf
- Crown molding on three sides

Freight Class: 125

<b>TR_B52</b>	<b>QS</b> 36" X 16" X 52" Cubic Ft: 22.5 Ship Weight: 134	<b>790</b>	<b>802</b>	<b>814</b>
---------------	---	------------	------------	------------

**QS FINISHES** M

**Five Shelf Bookcase**



- Three adjustable shelves
- Two fixed shelves (middle and bottom)
- 1" thick shelves
- Crown molding on three sides

Freight Class: 125

<b>TR_B76</b>	<b>QS</b> 36" X 16" X 77" Cubic Ft: 31.9 Ship Weight: 185	<b>1082</b>	<b>1098</b>	<b>1114</b>
---------------	---	-------------	-------------	-------------

**QS FINISHES** M

**Two Door Bookcase**



- Two door storage area
- Two adjustable shelves on top
- One fixed shelf (above doors)
- One adjustable shelf in cabinet
- 1" thick shelves
- Crown molding on three sides

Freight Class: 125

<b>TR_762D</b>	<b>QS</b> 36" X 16" X 77" Cubic Ft: 31.9 Ship Weight: 218	<b>1260</b>	<b>1279</b>	<b>1298</b>
----------------	---	-------------	-------------	-------------

**QS FINISHES** M

**Bookcase Wall Unit**



- Three adjustable shelves
- 1" thick shelves
- Two fixed shelves (middle and bottom)
- TR\_W72 prebored and includes fittings to make flush connection to add-on units
- TR\_W72NH not prebored
- Crown molding on front only

Freight Class: 125

<b>TR_W72</b>	<b>QS</b> 34" X 16" X 72" Cubic Ft: 30.3 Ship Weight: 176	<b>987</b>	<b>1002</b>	<b>1017</b>
---------------	---	------------	-------------	-------------

<b>TR_W72NH</b>	34" X 16" X 72" Cubic Ft: 30.3 Ship Weight: 176	<b>987</b>	<b>1002</b>	<b>1017</b>
-----------------	---	------------	-------------	-------------

**QS FINISHES** M

**Two Door Bookcase Wall Unit**



- Two door enclosed storage area
- Two adjustable shelves on top
- One fixed shelf (above doors)
- One adjustable shelf in cabinet
- TR\_W722D prebored and includes fittings to make flush connection to add-on units
- TR\_W722DNH not prebored
- 1" thick shelves
- Crown molding on front only

Freight Class: 125

<b>TR_W722D</b>	<b>QS</b> 34" X 16" X 72" Cubic Ft: 30.3 Ship Weight: 208	<b>1190</b>	<b>1208</b>	<b>1226</b>
-----------------	---	-------------	-------------	-------------

<b>TR_W722DNH</b>	34" X 16" X 72" Cubic Ft: 30.3 Ship Weight: 208	<b>1190</b>	<b>1208</b>	<b>1226</b>
-------------------	---	-------------	-------------	-------------

**QS FINISHES** M

**Storage Cabinet**

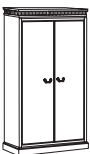

- Storage cabinet with four full-width adjustable shelves behind two full height doors
- Crown molding on three sides

Freight Class: 125

<b>TR_76DS</b>	36" X 24" X 77" Cubic Ft: 48 Ship Weight: 309	<b>1913</b>	<b>1942</b>	<b>1970</b>
----------------	---	-------------	-------------	-------------

TRADITIONAL LAMINATE



TR <b>M</b> 76DWD
Finish

Zone Pricing	1	2	3
--------------	---	---	---

### Multi-Use Wardrobe/Storage

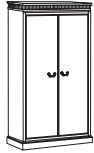

- Two door storage area
- Coat rod mounted in left side
- Four adjustable shelves in right
- Both sides drilled for adjustable shelves
- Individually locking doors
- Crown molding on three sides

Freight Class: 125

<b>TR_76DWD</b>	36" X 24" X 77" Cubic Ft: 48 Ship Weight: 309	<b>2061</b>	<b>2092</b>	<b>2123</b>
-----------------	---	-------------	-------------	-------------

## Reception Screens & Tables

### Reception Screen for Main

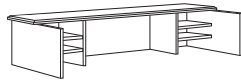

- TR\_3010 - Fits 66" x 30" desks
- TR\_3009 - Fits 72" x 36" desks
- Non-skid rubber strips on bottom prohibits movement
- Four adjustable shelves

Freight Class: 70

<b>TR_3010 QS</b>	66" X 28" X 14" Cubic Ft: 28.9 Ship Weight: 129	<b>1033</b>	<b>1048</b>	<b>1064</b>
<b>TR_3009</b>	72" X 36" X 14" Cubic Ft: 31.9 Ship Weight: 139	<b>1357</b>	<b>1377</b>	<b>1398</b>

**QS FINISHES M**

### Reception Screen for Return



- Fits 48" x 24" executive height return
- Hardware included to join to main reception screen
- TR\_3011L fits left return
- TR\_3011R fits right return
- Assembly required

Freight Class: 70

<b>TR_3011L QS</b>	48" X 22" X 14" Cubic Ft: 1.5 Ship Weight: 25	<b>236</b>	<b>240</b>	<b>243</b>
<b>TR_3011R QS</b>	48" X 22" X 14" Cubic Ft: 1.5 Ship Weight: 25	<b>236</b>	<b>240</b>	<b>243</b>

**QS FINISHES M**

### Computer Table

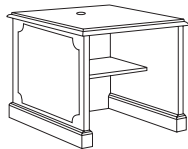

- One adjustable shelf
- Access slot in back
- One wire management grommet in top and one in modesty panel

Freight Class: 150

<b>TR_3095 QS</b>	36" X 30" X 29" Cubic Ft: 22.7 Ship Weight: 135	<b>1066</b>	<b>1082</b>	<b>1098</b>
	<b>Keyboard Platform K</b>	193	196	199

**QS FINISHES M**

Discontinued after October 1, 2012

### Traditional Cocktail Table



- High-gloss, high pressure laminate top in Mahogany and Windsor Cherry
- Shaped edges
- Ships unassembled, easy assembly

Freight Class: 100

<b>TR_4020 QS</b>	54" X 24" X 16" Cubic Ft: 5.5 Ship Weight: 69.5	<b>748</b>	<b>759</b>	<b>770</b>
-------------------	---	------------	------------	------------

**QS FINISHES M**

Finish Options: Mahogany (M), Windsor Cherry (WC) and Oak (O)  
Note: Oak finish has a satin laminate top

### Traditional End Table

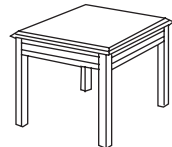

- High-gloss, high pressure laminate top in Mahogany and Windsor Cherry
- Shaped edges
- Ships unassembled, easy assembly

Freight Class: 92.5

<b>TR_4023 QS</b>	22" X 27" X 18" Cubic Ft: 2.5 Ship Weight: 38	<b>618</b>	<b>627</b>	<b>637</b>
-------------------	---	------------	------------	------------

**QS FINISHES M**

Finish Options: Mahogany (M), Windsor Cherry (WC) and Oak (O)  
Note: Oak finish has a satin laminate top

**Center Drawers & Keyboard Platforms**

Zone Pricing	1	2	3
--------------	---	---	---

**Center Drawer**



- TR\_29 Fits 60" double pedestal desks
- TR\_30 Fits 72" double pedestal desks
- TR\_32 Fits 66" double pedestal desks

<b>TR_29 QS</b>	26.75" X 18.75" X 3.75" Cubic Ft: 1.5 Ship Weight: 12	<b>162</b>	<b>164</b>	<b>167</b>
<b>TR_30 QS</b>	38.75" X 18.75" X 3.75" Cubic Ft: 2.2 Ship Weight: 13	<b>176</b>	<b>179</b>	<b>181</b>
<b>TR_32 QS</b>	32.75" X 18.75" X 3.75" Cubic Ft: 2.2 Ship Weight: 13	<b>176</b>	<b>179</b>	<b>181</b>

**QS FINISHES** M

Freight Class: 100

**Keyboard Platform**

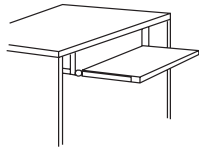

- Requires a 26" kneespace for installation
- Platform only, does not include table

<b>TR_3096 QS</b>	21" X 18" Cubic Ft: 1.5 Ship Weight: 12	<b>193</b>	<b>196</b>	<b>199</b>
-------------------	---	------------	------------	------------

**QS FINISHES** M

Freight Class: 92.5

UNIT	KNEESPACE	OVERHANG
72" Double Pedestal Desk	39"	8-1/2"
66" Double Pedestal Desk	33"	2-1/2"
60" Double Pedestal Desk	27"	2-1/2"
72" Double Pedestal Credenza	39"	n/a
60" Double Pedestal Credenza	27"	n/a

TRADITIONAL LAMINATE

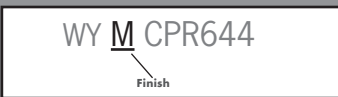

## FINISHES

Wyndham is available in Mahogany, Medium Oak and Windsor Cherry finishes. All finishes are thermally fused laminates unless otherwise noted. A high pressure, high gloss laminate top option is available for a 15% pricing upcharge. A six-week lead time will apply. High pressure laminate tops are only offered in Windsor Cherry and Mahogany. Contact your customer service representative to discuss specific high pressure laminate needs and delivery quotes. To order high pressure laminate tops in Windsor Cherry or Mahogany add T before the WY and add 15% to the list price of the item.

**Example:** TWYM601

**CONSTRUCTION:** *Pedestals, Credenzas, File Cabinets and Storage Units:* All cases are 3/4" thick core surfaced on the outside with laminate and edge banded as required. Units fully assembled with dowels/glue, wood cleats, metal brackets and screws. Series features full modesty panels. This series features picture frame molding on ends and backs. There is no molding on modesty panels or bridge. Series features full modesty panel.

## TOPS

All tops are 1" thick MDF surfaced in thermally fused laminate and are properly backed. All bridge and return tops feature common grain direction with desk/credenza as well as reverse coped edges for smooth work surface connection with desk/credenza. Work surface dimensions will vary due to edge profile.

## DRAWERS

All drawer fronts are constructed of 3/4" thick core with thermally fused laminate on both sides and edge banded as required. Drawer sides are 1/2" thick, oak grained pattern. Drawer bottoms are 1/8" thick oak-grain hardboard.

- All box drawers are suspended on smooth-action metal slides with ball bearings
- All file drawers and file cabinet drawers are mounted on heavy-duty ball bearing, full-extension slides
- Black filing hardware includes pre-installed rails with easy-adjust crossbar
- All file drawers allow letter filing, front-to-back and legal size filing side-to-side
- All 38" lateral file drawers allow letter and/or legal filing front-to-back or legal size filing side-to-side
- 32" lateral file drawers allow legal filing side-to-side and letter filing front-to-back
- Maximum weight for bottom loading is

25 lb

- Drawers are constructed with 5 sides for extra strength and durability. The drawer front is the 5th side and is removable in the field for repairs or hardware additions

## PEDESTALS

Supported with 4 leveling glides in steel plate.

## PANELS

Heavy-duty adjustable nylon leveling glides in steel plate are installed in each 1" thick end panel. Modesty panels are 3/4" thick core.

## BASES

All bases are 1" thick fiberboard surfaced with melamine.

## GROMMETS

All grommets in the Wyndham collection are round and made of black high impact poly resin. See features for number of grommets and location. Additional grommets can be added for extended wire management capability at \$106 list per grommet. Includes factory cut and installed grommet and black sleeve. Call for special quote. Specify location and quote number with order.

## HARDWARE

Pulls and knobs are a beautiful traditional design, solid metal, with a brass finish to complement the Wyndham collection.

## TACK BOARDS

Fabric covered tackable boards may be ordered separately to fit inside hutches. They can be ordered with any fabric to match your office chairs except leather or vinyl.

## LOCKS

- Independent fully locking pedestals are standard on all desks and credenzas
- Two drawer and four drawer lateral files are central locking
- Four drawer lateral files feature central locking and are keyed different than other locks due to the anti-tilt mechanism inside the unit
- All locks are keyed identical unless otherwise specified
- 'Key Different' option is \$21 list upcharge per lock. Locks/cores packaged to customer requirements
- Additional lead time for 'Key Different'
- For optional locking on overhead storage units with four wood doors, add Y to the end of the model number and add \$150 to the list price of unit

## ACCESSORIES *Factory Installed*

Certain accessories can be ordered installed prior to shipment. Add letter designator (C, K or T) at end of the desk, credenza or overhead model number:

- C** Center Drawer  
*Example: WYM651RC*
- K** Keyboard Platform  
*Example: WYM604K*
- T** Task Light  
*Example: WYM737T*

## DIMENSIONS

All size dimensions are nominal and subject to change. If you must have exact dimensions, please contact your Customer Service Representative. Worksurface dimensions will vary due to edge profile treatment. Always measure actual top before ordering glass or other cover to fit tops.

## QUICKSHIP

Quick Ship is not available on any items ordered with option.

## PACKING

All units are properly packed in heavy duty cartons with heavy duty corner pads. All packaging conforms to or exceeds specifications as outlined in the Uniform Freight Classification. All desks, credenzas, files, and overhead storage units are shipped set up. Modular L-shaped, and U-shaped workstations are shipped in multiple cartons and require connection in the field.

## PALLETIZATION

See page 3.

## CARE & CLEANING INSTRUCTIONS

Normal cleaning: Clean using a soft cloth and a good window cleaner which contains no ammonia, followed by wiping dry using a dry soft cloth.

**Specifications subject to change without notice.**



FINISH SELECTION

MAHOGANY **M** | MEDIUM OAK **O** | WINDSOR CHERRY **WC** |

SIN 711-2 **WYNDHAM**

**Configurations**

Zone Pricing	1	2	3
--------------	---	---	---

**L-Shaped Workstation**

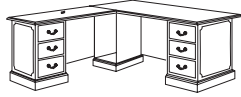

Description	Model Number	Qty	Frft.Class	Cubic Ft.	Ship Weight			
Right Pedestal Desk	WY_651R 66" x 30" x 29"	1	110	40.2	246	<b>1464</b>	<b>1486</b>	<b>1508</b>
Desk Height Left Return	WY_722L 48" x 24" x 29"	1	110	24.3	152	<b>1184</b>	<b>1202</b>	<b>1220</b>
Total:				64.50	398	<b>2648</b>	<b>2688</b>	<b>2728</b>

66" x 78" x 29"

**U-Shaped Workstation**

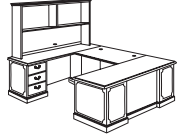

Description	Model Number	Qty	Frft.Class	Cubic Ft.	Ship Weight			
Right Pedestal Desk	WY_651R 66" x 30" x 29"	1	110	40.2	246	<b>1464</b>	<b>1486</b>	<b>1508</b>
Desk Height Bridge	WY_485 48" x 24" x 29"	1	100	4.0	67	<b>596</b>	<b>605</b>	<b>614</b>
Left Pedestal Credenza	WY_625L 66" x 24" x 29"	1	125	32.8	202	<b>1516</b>	<b>1539</b>	<b>1561</b>
Overhead Storage Unit	WY_677 66" x 19" x 37"	1	125	30.1	193	<b>1427</b>	<b>1448</b>	<b>1470</b>
Total:				107.10	708	<b>5003</b>	<b>5078</b>	<b>5153</b>

66" x 102" x 66"

**Desks**

**Double Pedestal Desk**



- Two box drawers
- Two file drawers
- Pre-installed filing hardware for letter or legal filing
- Individual locking pedestals

<b>WY_601</b>	<b>QS</b>	60" X 30" X 29"	Cubic Ft: 36.7	Ship Weight: 264	<b>1663</b>	<b>1688</b>	<b>1713</b>	
					<b>Center Drawer C</b>	149	151	153
<b>WY_659</b>	<b>QS</b>	66" X 30" X 29"	Cubic Ft: 40.2	Ship Weight: 277	<b>1706</b>	<b>1732</b>	<b>1757</b>	
					<b>Center Drawer C</b>	163	165	168
<b>WY_719</b>	<b>QS</b>	72" X 36" X 29"	Cubic Ft: 51.6	Ship Weight: 303	<b>1839</b>	<b>1867</b>	<b>1894</b>	
					<b>Center Drawer C</b>	163	165	168

Freight Class: 110

**QS FINISHES** **O** **M**

**Left Pedestal Desk**



- One box drawer
- One file drawer
- Pre-installed filing hardware for letter or legal filing
- Locking pedestals
- Extra open storage pedestal on connecting side

<b>WY_651L</b>	<b>QS</b>	66" X 30" X 29"	Cubic Ft: 40.2	Ship Weight: 246	<b>1464</b>	<b>1486</b>	<b>1508</b>	
					<b>Center Drawer C</b>	149	151	153
<b>WY_700L</b>		72" X 30" X 29"	Cubic Ft: 44.4	Ship Weight: 256	<b>1583</b>	<b>1607</b>	<b>1630</b>	
					<b>Center Drawer C</b>	149	151	153
<b>WY_721L</b>		72" X 36" X 29"	Cubic Ft: 51.6	Ship Weight: 265	<b>1638</b>	<b>1663</b>	<b>1687</b>	
					<b>Center Drawer C</b>	149	151	153

Freight Class: 110

**QS FINISHES** **O** **M**

**Right Pedestal Desk**

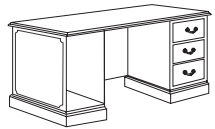

- One box drawer
- One file drawer
- Pre-installed filing hardware for letter or legal filing
- Locking pedestals
- Extra open storage pedestal on connecting side

<b>WY_651R</b>	<b>QS</b>	66" X 30" X 29"	Cubic Ft: 40.2	Ship Weight: 246	<b>1464</b>	<b>1486</b>	<b>1508</b>	
					<b>Center Drawer C</b>	149	151	153
<b>WY_700R</b>		72" X 30" X 29"	Cubic Ft: 44.4	Ship Weight: 256	<b>1583</b>	<b>1607</b>	<b>1630</b>	
					<b>Center Drawer C</b>	149	151	153
<b>WY_721R</b>		72" X 36" X 29"	Cubic Ft: 51.6	Ship Weight: 265	<b>1638</b>	<b>1663</b>	<b>1687</b>	
					<b>Center Drawer C</b>	149	151	153

Freight Class: 110

**QS FINISHES** **O** **M**

UNIT	KNEESPACE	OVERHANG
72" Double Pedestal Desk	39"	6-1/2"
66" Double Pedestal Desk	33"	2-1/2"
60" Double Pedestal Desk	27"	2-1/2"
72" Double Pedestal Credenza	39"	n/a
66" Double Pedestal Credenza	33"	n/a

TRADITIONAL LAMINATE



## Credenzas

Zone Pricing

1

2

3

### Computer Credenza with CPU Storage

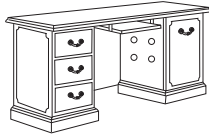

- CPU storage pedestal on hand side of unit
- Box/File pedestal on other side
- Pre-installed filing hardware for letter or legal filing
- Pullout keyboard platform standard
- Locking drawer pedestal
- One grommet in modesty, four in inside panel of CPU pedestal

Freight Class: 110

<b>WY_CPL644</b>	66" X 24" X 29"	Cubic Ft: 32.8	Ship Weight: 223	<b>1624</b>	<b>1648</b>	<b>1673</b>
<b>WY_CPR644</b>	66" X 24" X 29"	Cubic Ft: 32.8	Ship Weight: 223	<b>1624</b>	<b>1648</b>	<b>1673</b>
<b>WY_CPL744</b>	72" X 24" X 29"	Cubic Ft: 40.2	Ship Weight: 246	<b>1719</b>	<b>1745</b>	<b>1771</b>
<b>WY_CPR744</b>	72" X 24" X 29"	Cubic Ft: 40.2	Ship Weight: 246	<b>1719</b>	<b>1745</b>	<b>1771</b>

### Computer Credenza



- Two box drawers
- Two file drawers, letter or legal filing
- Individual locking pedestals
- Pullout keyboard platform standard on WY\_744
- One grommet in modesty panel

Freight Class: 110

<b>WY_604</b>	<b>QS</b>	66" X 24" X 29"	Cubic Ft: 32.8	Ship Weight: 235	<b>1624</b>	<b>1648</b>	<b>1673</b>	
					<b>Keyboard Platform K</b>	199	202	205
<b>WY_744</b>	<b>QS</b>	72" X 24" X 29"	Cubic Ft: 40.2	Ship Weight: 255	<b>1719</b>	<b>1745</b>	<b>1771</b>	

**QS FINISHES** **O** **M**

### Computer Credenza



- Two box drawers
- Two file drawers, letter or legal filing
- Extra wide keyboard drawer with flip down front
- Individual locking pedestals
- One grommet in modesty panel

Freight Class: 110

<b>WY_645DK</b>	66" X 24" X 29"	Cubic Ft: 32.8	Ship Weight: 259	<b>1856</b>	<b>1884</b>	<b>1912</b>
<b>WY_745DK</b>	72" X 24" X 29"	Cubic Ft: 40.2	Ship Weight: 270	<b>2119</b>	<b>2151</b>	<b>2183</b>

### Single Pedestal Credenza

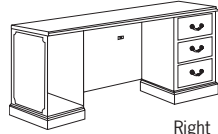

- One box drawer
- One file drawer, letter or legal filing
- One grommet in modesty panel

- Locking pedestal
- Extra open storage pedestal on connecting side

Freight Class: 125

<b>WY_625L</b>	<b>QS</b>	66" X 24" X 29"	Cubic Ft: 32.8	Ship Weight: 202	<b>1516</b>	<b>1539</b>	<b>1561</b>	
					<b>Keyboard Platform K</b>	196	199	202
<b>WY_725L</b>		72" X 24" X 29"	Cubic Ft: 40.2	Ship Weight: 218	<b>1620</b>	<b>1644</b>	<b>1669</b>	
					<b>Keyboard Platform K</b>	196	199	202
<b>WY_625R</b>	<b>QS</b>	66" X 24" X 29"	Cubic Ft: 32.8	Ship Weight: 202	<b>1516</b>	<b>1539</b>	<b>1561</b>	
					<b>Keyboard Platform K</b>	196	199	202
<b>WY_725R</b>		72" X 24" X 29"	Cubic Ft: 40.2	Ship Weight: 218	<b>1620</b>	<b>1644</b>	<b>1669</b>	
					<b>Keyboard Platform K</b>	196	199	202

**QS FINISHES** **O** **M**

### Storage Credenza



- Two box drawers
- Two file drawers, letter or legal filing
- Individual locking pedestals
- Storage compartment with one adjustable shelf
- Two hinged doors

Freight Class: 125

<b>WY_672</b>	66" X 24" X 29"	Cubic Ft: 32.8	Ship Weight: 278	<b>1934</b>	<b>1963</b>	<b>1992</b>
<b>WY_704</b>	72" X 24" X 29"	Cubic Ft: 40.2	Ship Weight: 298	<b>2133</b>	<b>2165</b>	<b>2197</b>

### Double Lateral File Credenza



- Four lateral file drawers
- Pre-installed filing hardware for letter or legal filing
- Side locking

Freight Class: 125

<b>WY_733</b>	72" X 24" X 29"	Cubic Ft: 35.7	Ship Weight: 368	<b>2326</b>	<b>2361</b>	<b>2396</b>
---------------	-----------------	----------------	------------------	-------------	-------------	-------------

**EXTRA THICK BOTTOM** \$320 **H**

TRADITIONAL LAMINATE

# FINISH SELECTION

MAHOGANY **M** | MEDIUM OAK **O** | WINDSOR CHERRY **WC** |

# SIN 711-2 WYNDHAM

## Lateral File Credenza



Left



Right

- Two lateral file drawers
- Pre-installed hardware for letter or legal filing

- Side locking
- Extra open storage pedestal on connecting side

Freight Class: 125

## Returns & Bridge

### Desk Height Return

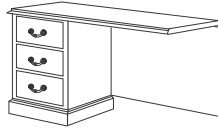

- One box drawer
- One file drawer, letter or legal filing
- One grommet in modesty panel

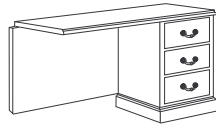

Right Shown

- Locking pedestal
- Reversed coped edge for smooth connection
- Common grain direction with desk

Freight Class: 110

### Desk Height Bridge

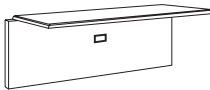

- One grommet in modesty panel
- Reversed coped edge on connecting sides
- Common grain direction with desk/credenza

Freight Class: 100

## Files, Bookcase & Overhead Storage

### Two Drawer File



Freight Class: 100

- Two file drawers
- Pre-installed filing hardware for letter or legal filing
- Side locking pedestal

### Standard Lateral File



Freight Class: 100

- Two lateral file drawers
- Pre-installed filing hardware for letter or legal filing
- Side locking
- Anti-tilt mechanism inhibits more than one drawer from opening at a time

Zone Pricing	1	2	3
--------------	---	---	---

<b>WY_733L</b>	72" X 24" X 29"	Cubic Ft: 35.7	Ship Weight: 254	<b>1708</b>	<b>1734</b>	<b>1759</b>
<b>WY_733R</b>	72" X 24" X 29"	Cubic Ft: 35.7	Ship Weight: 368	<b>1708</b>	<b>1734</b>	<b>1759</b>

**EXTRA THICK BOTTOM** \$160 H

<b>WY_722L</b>	<b>QS</b>	48" X 24" X 29"	Cubic Ft: 24.3	Ship Weight: 152	<b>1184</b>	<b>1202</b>	<b>1220</b>	
					<b>Keyboard Platform K</b>	196	199	202
<b>WY_722R</b>	<b>QS</b>	48" X 24" X 29"	Cubic Ft: 24.3	Ship Weight: 152	<b>1184</b>	<b>1202</b>	<b>1220</b>	
					<b>Keyboard Platform K</b>	196	199	202
<b>WY_622L</b>		42" X 24" X 29"	Cubic Ft: 21.8	Ship Weight: 142	<b>1162</b>	<b>1179</b>	<b>1197</b>	
					<b>Keyboard Platform K</b>	196	199	202
<b>WY_622R</b>		42" X 24" X 29"	Cubic Ft: 21.8	Ship Weight: 142	<b>1162</b>	<b>1179</b>	<b>1197</b>	
					<b>Keyboard Platform K</b>	196	199	202

**QS FINISHES** **O** **M**

<b>WY_485</b>	<b>QS</b>	48" X 24" X 29"	Cubic Ft: 4	Ship Weight: 67	<b>596</b>	<b>605</b>	<b>614</b>
---------------	-----------	-----------------	-------------	-----------------	------------	------------	------------

**QS FINISHES** **O** **M**

<b>WY_2DF</b>	<b>QS</b>	17" X 24" X 29"	Cubic Ft: 10	Ship Weight: 111	<b>927</b>	<b>941</b>	<b>955</b>
---------------	-----------	-----------------	--------------	------------------	------------	------------	------------

**QS FINISHES** **O** **M**

<b>WY_326</b>		32" X 20" X 29"	Cubic Ft: 14	Ship Weight: 149	<b>1101</b>	<b>1118</b>	<b>1134</b>
---------------	--	-----------------	--------------	------------------	-------------	-------------	-------------

**EXTRA THICK BOTTOM** \$160 H

TRADITIONAL LAMINATE



WY <u>M</u> 346
Finish

Zone Pricing	1	2	3
--------------	---	---	---

### Executive Lateral File



Freight Class: 100

- Two lateral file drawers
- Pre-installed filing hardware for letter or legal filing
- Side locking
- Anti-tilt mechanism inhibits more than one drawer from opening at a time

<b>WY_346</b>	<b>QS</b>	38" X 24" X 29"	Cubic Ft: 19.5	Ship Weight: 198	<b>1228</b>	<b>1246</b>	<b>1265</b>
---------------	-----------	-----------------	----------------	------------------	-------------	-------------	-------------

<b>QS FINISHES</b>	<b>O</b>	<b>M</b>
--------------------	----------	----------

<b>EXTRA THICK BOTTOM</b>	<b>\$160 H</b>
---------------------------	----------------

### Three Drawer Lateral File



Freight Class: 100

- Three lateral file drawers
- Pre-installed filing hardware for letter or legal filing
- Central locking
- Anti-tilt mechanism inhibits more than one drawer from opening at a time

<b>WY_336</b>		32" X 21" X 44.5"	Cubic Ft: 27.9	Ship Weight: 215	<b>1859</b>	<b>1887</b>	<b>1915</b>
---------------	--	-------------------	----------------	------------------	-------------	-------------	-------------

<b>EXTRA THICK BOTTOM</b>	<b>\$240 H</b>
---------------------------	----------------

### Four Drawer Lateral File



Freight Class: 100

- Four lateral file drawers, letter and legal filing
- Central locking front
- Anti-tilt mechanism inhibits more than one drawer from opening at a time

<b>WY_426</b>		32" X 21" X 56"	Cubic Ft: 27.9	Ship Weight: 252	<b>2120</b>	<b>2152</b>	<b>2184</b>
---------------	--	-----------------	----------------	------------------	-------------	-------------	-------------

<b>EXTRA THICK BOTTOM</b>	<b>\$320 H</b>
---------------------------	----------------

### Overhead Storage Unit

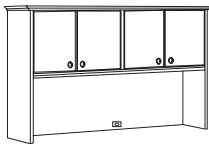

Freight Class: 125

- WY\_677 fits 66" credenzas
- WY\_737 fits 72" credenzas
- Two storage compartments
- 21" clearance under compartments
- One wire management grommet in back panel
- Optional tackboard available

<b>WY_677</b>	<b>QS</b>	66" X 19" X 37"	Cubic Ft: 30.1	Ship Weight: 193	<b>1427</b>	<b>1448</b>	<b>1470</b>
---------------	-----------	-----------------	----------------	------------------	-------------	-------------	-------------

<b>Task Light T</b>	124	126	128
<b>LED Task Light L</b>	212	215	218

<b>WY_737</b>	<b>QS</b>	72" X 19" X 37"	Cubic Ft: 33.6	Ship Weight: 220	<b>1625</b>	<b>1649</b>	<b>1674</b>
---------------	-----------	-----------------	----------------	------------------	-------------	-------------	-------------

<b>Task Light T</b>	124	126	128
<b>LED Task Light L</b>	212	215	218

<b>QS FINISHES</b>	<b>O</b>	<b>M</b>
--------------------	----------	----------

<b>Locks:</b>	<b>\$150_Y</b>
---------------	----------------

### Open Overhead Storage

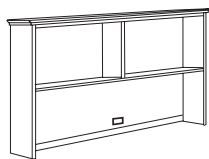

Freight Class: 125

- WY\_717 fits 72" credenzas
- WY\_617 fits 66" credenzas
- Two storage compartments
- 21" clearance under compartments
- One wire management grommet in back panel
- Optional tackboard available

<b>WY_617</b>		66" X 19" X 37"	Cubic Ft: 30.1	Ship Weight: 150	<b>823</b>	<b>835</b>	<b>848</b>
---------------	--	-----------------	----------------	------------------	------------	------------	------------

<b>Task Light T</b>	124	126	128
<b>LED Task Light L</b>	212	215	218

<b>WY_717</b>		72" X 19" X 37"	Cubic Ft: 33.6	Ship Weight: 210	<b>1070</b>	<b>1086</b>	<b>1102</b>
---------------	--	-----------------	----------------	------------------	-------------	-------------	-------------

<b>Task Light T</b>	124	126	128
<b>LED Task Light L</b>	212	215	218

### Bookcase



Freight Class: 125

- Three adjustable shelves
- Two fixed shelves (middle and bottom)
- 1" thick shelves
- Crown and base molding on three sides

<b>WY_65</b>	<b>QS</b>	38" X 19" X 65"	Cubic Ft: 31.9	Ship Weight: 241	<b>898</b>	<b>911</b>	<b>925</b>
--------------	-----------	-----------------	----------------	------------------	------------	------------	------------

<b>QS FINISHES</b>	<b>O</b>	<b>M</b>
--------------------	----------	----------

FINISH SELECTION

MAHOGANY **M** | MEDIUM OAK **O** | WINDSOR CHERRY **WC** |

SIN 711-2 **WYNDHAM**

Reception Screens

Zone Pricing	1	2	3
--------------	---	---	---

Reception Screen for Main

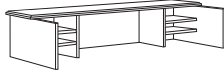

- Fits 66" x 30" single pedestal or double pedestal desks
- Matte finish
- Non-skid rubber strips on bottom prohibit movement
- Four adjustable shelves

<b>WY_610</b>	<b>QS</b>	66" X 28" X 14"	Cubic Ft: 28.9	Ship Weight: 129	<b>942</b>	<b>956</b>	<b>970</b>
---------------	-----------	-----------------	----------------	------------------	------------	------------	------------

<b>QS FINISHES</b>	<b>O</b>	<b>M</b>
--------------------	----------	----------

Freight Class: 70

Reception Screen for Return



- Fits 48" x 24" executive height return
- Hardware included to join to main reception screen
- WY\_611L fits left return
- WY\_611R fits right return
- One wire management grommet
- Assembly required

<b>WY_611L</b>	<b>QS</b>	48" X 22" X 13"	Cubic Ft: 1.5	Ship Weight: 25	<b>223</b>	<b>226</b>	<b>230</b>
<b>WY_611R</b>	<b>QS</b>	48" X 22" X 13"	Cubic Ft: 1.5	Ship Weight: 25	<b>223</b>	<b>226</b>	<b>230</b>

<b>QS FINISHES</b>	<b>O</b>	<b>M</b>
--------------------	----------	----------

Freight Class: 70

Center Drawers

Center Drawer

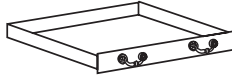

- WY\_18 fits L-shaped and U-shaped workstations
- WY\_19 fits 60" double pedestal desks
- WY\_32 fits 66" double pedestal desks
- WY\_38 fits 72" double pedestal desks





<b>WY_18</b>	<b>QS</b>	25" X 18" X 3"	Cubic Ft: 1.5	Ship Weight: 11	<b>149</b>	<b>151</b>	<b>153</b>
<b>WY_19</b>	<b>QS</b>	26.75" X 18" X 3"	Cubic Ft: 2	Ship Weight: 12	<b>149</b>	<b>151</b>	<b>153</b>
<b>WY_32</b>	<b>QS</b>	32.75" X 18" X 3"	Cubic Ft: 2.2	Ship Weight: 13	<b>163</b>	<b>165</b>	<b>168</b>
<b>WY_38</b>	<b>QS</b>	38.75" X 18" X 3"	Cubic Ft: 2.2	Ship Weight: 13	<b>163</b>	<b>165</b>	<b>168</b>

<b>QS FINISHES</b>	<b>O</b>	<b>M</b>
--------------------	----------	----------

Freight Class: 100

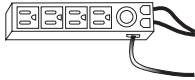
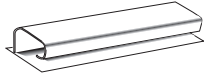
TRADITIONAL LAMINATE

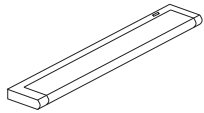
# ACCESSORIES SIN 711-2

Technology		Zone Pricing	1	2	3
<b>CPU Storage Unit</b>  Freight Class: 100		<b>MDCPU QS</b> Cubic Ft: 1 Ship Weight: 20	<b>255</b>	<b>259</b>	<b>263</b>
<ul style="list-style-type: none"> <li>• Mounts under workstation</li> <li>• Capable of housing tower or desk top styles CPU</li> <li>• Unit slides in/out and rotates for easy access</li> </ul>					
<b>Power Strips</b>  Freight Class: 75		<b>MDE QS</b> Cubic Ft: 1 Ship Weight: 2	<b>133</b>	<b>135</b>	<b>137</b>
<ul style="list-style-type: none"> <li>• Moulded of high impact, flame resistant plastic</li> <li>• Four electrical outlets</li> <li>• Two data lines</li> <li>• UL and CSA certified</li> <li>• Surge protection</li> <li>• RJ 11 jack- hook up for phone, modem or fax</li> <li>• Ratings: 120 volt, 60 Hz, 13 amp</li> </ul>					
<b>Wire Management Channel</b>  Freight Class: 100		<b>MDWM QS</b> 12" x 2.25" x 1.25" Cubic Ft: .04 Ship Weight: 1	<b>26</b>	<b>26</b>	<b>27</b>
<ul style="list-style-type: none"> <li>• Attaches under tops or to modesty panels for wire concealment and management</li> <li>• Peel and stick self adhesive</li> <li>• Front end opening for easy access</li> </ul>					
<b>Task Light</b>  Freight Class: 200		<b>TL2P QS</b> 19.5" x 3.25" x 1.25" Cubic Ft: 1 Ship Weight: 3	<b>124</b>	<b>126</b>	<b>128</b>
<ul style="list-style-type: none"> <li>• Pivots front/back positions</li> <li>• T4 Fluorescent bulb</li> <li>• 16 watt</li> <li>• 10 ft. powercord</li> <li>• UL labeled</li> </ul>		Factory-installation available: add <b>T</b> to end of overhead model number and prices above to list price of unit.			
<b>LED Task Light</b>  Freight Class: 200		<b>TLED QS</b> 20" x 2.34" x .875" Cubic Ft: 1 Ship Weight: 3	<b>212</b>	<b>215</b>	<b>218</b>
<ul style="list-style-type: none"> <li>• Black with clear lens and cool white light</li> <li>• Convenient on/off switch</li> <li>• 180 degree swivel feature</li> <li>• 600 Lumen, 7.5 watt</li> <li>• Input 100-240 V AC, 50/60 Hz</li> <li>• 9" black power cord</li> </ul>		Factory-installation available: add <b>L</b> to end of overhead model number and prices above to list price of unit.			
<b>Coat Rack, Keyboard Trays &amp; Center Drawers</b>					
<b>Coat Rack</b>  Freight Class: 85		<b>93757_ QS</b> 9.5" x 9.5" x 72.75" Cubic Ft: 2 Ship Weight: 10	<b>376</b>	<b>382</b>	<b>387</b>
<ul style="list-style-type: none"> <li>• 4 legs</li> <li>• 4 double hooks</li> <li>• Solid hardwood</li> <li>• Finishes coordinate with seating and casegoods</li> <li>• Can be shipped via FedEx Ground</li> <li>• Assembly required</li> </ul>		<b>Finish Options:</b> Aspen ( <b>AP</b> ), Black ( <b>BLK</b> ), Honey Cherry ( <b>HCY</b> ), Mahogany ( <b>MAH</b> ), Medium Oak ( <b>OAK</b> ), Natural Maple ( <b>FM</b> ), Pearwood ( <b>PM</b> ), Rouge Mahogany ( <b>RM</b> ), Walnut ( <b>WAL</b> ), Windsor Cherry ( <b>WC</b> ), Classic Cherry ( <b>CCY</b> ), Espresso ( <b>ESP</b> ),			



Zone Pricing	1	2	3
--------------	---	---	---

**Pullout Keyboard Platform**

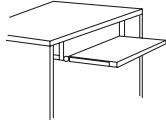

- HW\_K21 fits 60" double pedestal desks, 66" or 72" single pedestal desks, computer corner desks, 48" and 42" returns, extended corner returns and 30" and 36" shells
- HW\_K25 or HW\_K29 fits 66" or 72" double pedestal desks, computer credenzas, bridges and 42" and larger shells
- Available as Quick Ship in all Hyperwork finishes

Freight Class: 100

<b>HW_K25</b>	<b>QS</b>	25" x 18" x	Cubic Ft: 2	Ship Weight: 10	<b>196</b>	<b>199</b>	<b>202</b>
<b>HW_K21</b>	<b>QS</b>	21" x 18" x	Cubic Ft: 2	Ship Weight: 12	<b>196</b>	<b>199</b>	<b>202</b>
<b>HW_K29</b>	<b>QS</b>	29" x 18" x	Cubic Ft: 2	Ship Weight: 17	<b>203</b>	<b>206</b>	<b>209</b>

Use with Elevation, Atlas, Hyperwork and Agility

**Center Drawer**

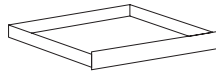

- HW\_CD19 fits 66" single pedestal desks
- HW\_CD25 fits 60" double pedestal desks, 72" and 48" single pedestal desks
- HW\_CD32 fits 66" double pedestal desks
- HW\_CD38 fits 72" double pedestal desks
- Available as Quick Ship in all Hyperwork finishes

Freight Class: 100

<b>HW_CD19</b>	<b>QS</b>	19.5" x 18" x 3"	Cubic Ft: 1.5	Ship Weight: 11	<b>165</b>	<b>167</b>	<b>170</b>
<b>HW_CD25</b>	<b>QS</b>	25.5" x 18" x 3"	Cubic Ft: 1.5	Ship Weight: 12	<b>165</b>	<b>167</b>	<b>170</b>
<b>HW_CD32</b>	<b>QS</b>	32" x 18" x 3"	Cubic Ft: 2.2	Ship Weight: 13	<b>177</b>	<b>180</b>	<b>182</b>
<b>HW_CD38</b>	<b>QS</b>	38" x 18" x 3"	Cubic Ft: 2.2	Ship Weight: 13	<b>177</b>	<b>180</b>	<b>182</b>

Use with Elevation, Atlas, Hyperwork and Agility

**Pullout Keyboard Platform**

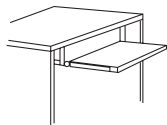

- Platform only; does not include table
- PKP35 requires a 26" kneespace and fits single pedestal units for L-shaped and U-shaped workstations
- PKMP36 requires 33" kneespace and fits 66" or 72" double pedestal desks, credenzas or bridges
- PKP25 fits 66" or 72" double pedestal desks, credenzas or bridges
- Available as Quick Ship in Mahogany (MAH), Natural Maple (FM), Grey (GRY), Medium Oak (MOK), Windsor Cherry (WC) and Gunstock Walnut (WAL)

Freight Class: 100

<b>PKP35_</b>	<b>QS</b>	22" x 18" x	Cubic Ft: 2	Ship Weight: 12	<b>196</b>	<b>199</b>	<b>202</b>
<b>PKP25_</b>	<b>QS</b>	22" x 18" x	Cubic Ft: 2	Ship Weight: 15	<b>199</b>	<b>202</b>	<b>205</b>
<b>PKMP36_</b>	<b>QS</b>	22" x 18" x	Cubic Ft: 2	Ship Weight: 17	<b>203</b>	<b>206</b>	<b>209</b>

Use with Vitality, 2200 Series, Bravo Panel and Wyndham

**Center Drawer**

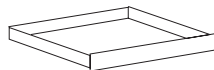

- CD\_18: Fits 66" single pedestal desks
- CD\_19: Fits 72" and 48" single pedestal desks or 60" double pedestal desks
- CD\_32: Fits 66" double pedestal desks
- CD\_30: Fits 72" double pedestal desks
- Available as Quick Ship in Mahogany (M), Natural Maple (FM), Grey (G), Medium Oak (O), Windsor Cherry (WC) and Gunstock Walnut (W)

Freight Class: 100

<b>CD_18</b>	<b>QS</b>	20" x 18" x 3"	Cubic Ft: 1.5	Ship Weight: 11	<b>160</b>	<b>162</b>	<b>165</b>
<b>CD_19</b>	<b>QS</b>	26" x 18" x 3"	Cubic Ft: 1.5	Ship Weight: 12	<b>160</b>	<b>162</b>	<b>165</b>
<b>CD_32</b>	<b>QS</b>	32" x 18" x 3"	Cubic Ft: 2.2	Ship Weight: 13	<b>172</b>	<b>175</b>	<b>177</b>
<b>CD_30</b>	<b>QS</b>	38" x 18" x 3"	Cubic Ft: 2.2	Ship Weight: 13	<b>172</b>	<b>175</b>	<b>177</b>

Use with 2200 Series and Bravo Panel

## Articulating Keyboard Supports

Zone Pricing	1	2	3
--------------	---	---	---

### Curved Platform 20.5" Free-Float

<b>AKT008/06720 QS</b>	21-29" x 13" x 22-32" Cubic Ft: 1.3 Ship Weight: 17	<b>595</b>	<b>604</b>	<b>613</b>
------------------------	---	------------	------------	------------

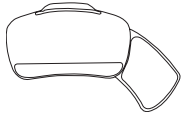

- Black finish
- Left/right-hand sliding mousepad
- Gel wristrest
- Cord managers
- Usable surface 18.5" W x 8" D
- Free-float mechanism
- Can be shipped via FedEx Ground

Freight Class: 70

### Curved Platform 23" Free-Float

<b>AKT008/06623 QS</b>	21-29" x 13" x 22-32" Cubic Ft: 1.3 Ship Weight: 18	<b>647</b>	<b>657</b>	<b>666</b>
------------------------	---	------------	------------	------------

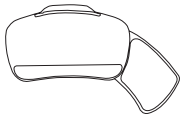

- Black finish
- Left/right-hand sliding mousepad
- Gel wristrest
- Cord managers
- Usable surface 18.5" W x 8" D
- Free-float mechanism
- Can be shipped via FedEx Ground

Freight Class: 70

### Rectangular Platform 17" Spring Assist

<b>AKT007/02517 QS</b>	22-31" x 12" x 22-32" Cubic Ft: 1.3 Ship Weight: 17	<b>412</b>	<b>418</b>	<b>424</b>
------------------------	---	------------	------------	------------



- Black finish
- Left/right-hand sliding mousepad
- Gel wristrest
- Cord managers
- Usable surface 21.25" W x 8.25" D
- Free-float mechanism
- Can be shipped via FedEx Ground

Freight Class: 70

### Rectangular Platform 20.5" Free-Float

<b>AKT007/06720.5 QS</b>	22-31" x 12" x 22-32" Cubic Ft: 1.3 Ship Weight: 18	<b>464</b>	<b>471</b>	<b>478</b>
--------------------------	---	------------	------------	------------



- Black finish
- Left/right-hand sliding mousepad
- Gel wristrest
- Cord managers
- Usable surface 21.25" W x 8.25" D
- Spring-Assist mechanism
- Can be shipped via FedEx Ground

Freight Class: 70

### Rectangular Platform 23" Free-Float

<b>AKT007/06623 QS</b>	22-31" x 12" x 22-32" Cubic Ft: 1.3 Ship Weight: 20	<b>518</b>	<b>526</b>	<b>534</b>
------------------------	---	------------	------------	------------



- Black finish
- Left/right-hand sliding mousepad
- Gel wristrest
- Cord managers
- Usable surface 21.25" W x 8.25" D
- Spring-Assist mechanism /23" track & 7.5 neck
- Can be shipped via FedEx Ground

Freight Class: 70

# SIN 711-2 WORKSURFACE ACCESSORIES

## Benching/Privacy Panels, Tack & White Boards

Zone  
Pricing

1

2

3

### Benching/Privacy Panels for Desktop



- 14" high benching/privacy panels for desktops in multi-station configurations
- Join with other panels to form "L" or "U" shapes, panels are not stand alone
- Joint Kit sold separate. order one kit per joint
- Available in all Hyperwork finishes

Freight Class: 100

Part #	Dimensions	Cubic Ft:	Ship Weight:	1	2	3
HS_24	24" X .75" X 14"	2	10	115	117	118
HS_30	30" X .75" X 14"	2	11	125	127	129
HS_36	36" X .75" X 14"	2	12	134	136	138
HS_42	42" X .75" X 14"	2	14	144	146	148
HS_48	48" X .75" X 14"	2	15	153	155	158
HS_54	54" X .75" X 14"	3	17	181	184	186
HS_60	60" X .75" X 14"	3	19	201	204	207
HS_66	66" X .75" X 14"	3	21	215	218	221
HS_72	72" X .75" X 14"	3	23	235	239	242
HS_78	78" X .75" X 14"	3	24	249	253	256

Use with Agility, Atlas, Elevation, Hyperwork and Bravo Panel Laminate Series

### Joint Kit

- Connects benching/privacy panels to form "L" or "U" shapes
- Kit includes two hinges and one wrench
- Hinges feature brushed nickel finish
- One kit required per connection

Freight Class: 100

Part #	Cubic Ft:	Ship Weight:	1	2	3
HSJK	0.3	1	177	180	182

### Tack Board for Privacy Panel



- Fabric covered fully tackable surface
- Pricing is for Grade 1 fabrics
- Contact your HPFI representative for other fabric grades
- Field installation required
- Tack boards fit privacy panels with corresponding numbers
- Quick Ship if ordered in QS fabric

Freight Class: 100

Part #	Dimensions	Cubic Ft:	Ship Weight:	1	2	3
HSTB24 QS	19.25" X 12"	1.4	3	166	168	171
HSTB30 QS	25.25" X 12"	1.4	3.25	168	171	173
HSTB36 QS	31.25" X 12"	1.4	3.5	170	173	175
HSTB42 QS	37.25" X 12"	1.4	3.75	186	189	192
HSTB48 QS	43.25" X 12"	1.4	4	188	191	194
HSTB54 QS	49.25" X 12"	1.4	4.25	198	201	204
HSTB60 QS	55.25" X 12"	1.4	4.5	200	203	206
HSTB66 QS	61.25" X 12"	1.4	4.75	202	205	208
HSTB72 QS	67.25" X 12"	1.4	5	204	207	210
HSTB78 QS	73.25" X 12"	1.4	5	206	209	212

### White Dry-Erase Board



- Use with erasable markers and dry eraser
- Field installation required
- White dry-erase boards fit privacy panels with corresponding numbers

Freight Class: 100

Part #	Dimensions	Cubic Ft:	Ship Weight:	1	2	3
HSWB24	19.25" X 12"	1.5	4	254	258	262
HSWB30	25.25" X 12"	1.5	4.5	293	297	302
HSWB36	31.25" X 12"	1.5	5	306	311	315
HSWB42	37.25" X 12"	1.5	6	362	367	373
HSWB48	43.25" X 12"	1.5	7	362	367	373
HSWB54	49.25" X 12"	1.5	8	411	417	423
HSWB60	55.25" X 12"	2.5	8	438	445	451
HSWB66	61.25" X 12"	2.5	10	448	455	461
HSWB72	67.25" X 12"	2.5	11	452	459	466
HSWB78	73.25" X 12"	2.5	12	463	470	477

ACCESSORIES

# WORKSURFACE ACCESSORIES SIN 711-2

## Accessory Wall



- Three channels for accessory attachment
- Accessories clip and lock into position
- Black color
- Field installation required
- Accessory walls fit privacy panels with corresponding numbers

Freight Class: 100

### Zone Pricing

1	2	3
---	---	---

<b>HSAW24</b>	19.25" X 0.5" X 12"	Cubic Ft: 1.4	Ship Weight: 3	<b>66</b>	<b>67</b>	<b>68</b>
<b>HSAW30</b>	25.25" X 0.5" X 7"	Cubic Ft: 1.4	Ship Weight: 3.25	<b>68</b>	<b>69</b>	<b>70</b>
<b>HSAW36</b>	31.25" X 0.5" X 7"	Cubic Ft: 1.4	Ship Weight: 3.5	<b>79</b>	<b>80</b>	<b>81</b>
<b>HSAW42</b>	37.25" X 0.5" X 7"	Cubic Ft: 1.4	Ship Weight: 3.75	<b>80</b>	<b>81</b>	<b>82</b>
<b>HSAW48</b>	43.25" X 0.5" X 12"	Cubic Ft: 1.4	Ship Weight: 4	<b>86</b>	<b>87</b>	<b>89</b>
<b>HSAW54</b>	49.25" X 0.5" X 7"	Cubic Ft: 1.4	Ship Weight: 4.25	<b>97</b>	<b>98</b>	<b>100</b>
<b>HSAW60</b>	55.25" X 0.5" X 7"	Cubic Ft: 1.4	Ship Weight: 4.5	<b>105</b>	<b>107</b>	<b>108</b>
<b>HSAW66</b>	61.25" X 0.5" X 7"	Cubic Ft: 1.4	Ship Weight: 4.75	<b>111</b>	<b>113</b>	<b>114</b>
<b>HSAW72</b>	67.25" X 0.5" X 7"	Cubic Ft: 1.4	Ship Weight: 5	<b>112</b>	<b>114</b>	<b>115</b>
<b>HSAW78</b>	72" X 0.5" X 7"	Cubic Ft: 1.4	Ship Weight: 5.25	<b>136</b>	<b>138</b>	<b>140</b>

## Tack Board 14" High For 72" Overhead **HWTB1472** 68.75" X 0.5" X 14"



- Fully tackable surface
- Choose any fabric
- Quick Ship in QS fabrics
- Not installed (shipped separate)
- Use with Vitality, Elevation, Atlas, Hyperwork, Westboro, Affirm and Inverness

68.75" X 0.5" X 14"

Freight Class: 100

Grade	1	2	3	4	5	6	7	8	9	10
<b>Zone 1</b>	<b>216</b>	<b>238</b>	<b>267</b>	<b>298</b>	<b>324</b>	<b>359</b>	<b>393</b>	<b>428</b>	<b>462</b>	<b>506</b>
<b>Zone 2</b>	<b>219</b>	<b>242</b>	<b>271</b>	<b>302</b>	<b>329</b>	<b>364</b>	<b>399</b>	<b>434</b>	<b>469</b>	<b>514</b>
<b>Zone 3</b>	<b>222</b>	<b>245</b>	<b>275</b>	<b>307</b>	<b>334</b>	<b>370</b>	<b>405</b>	<b>441</b>	<b>476</b>	<b>521</b>

Cubic Ft: 2.6

Ship Weight: 6

## Tack Board 14" High For 66" Overhead **HWTB1466** 63.25" X 0.5" X 14"



- Fully tackable surface
- Choose any fabric
- Quick Ship in QS fabrics
- Not installed (shipped separate)
- Use with Vitality, Elevation, Atlas, Hyperwork, Westboro, Affirm and Inverness

63.25" X 0.5" X 14"

Freight Class: 100

Grade	1	2	3	4	5	6	7	8	9	10
<b>Zone 1</b>	<b>216</b>	<b>238</b>	<b>267</b>	<b>298</b>	<b>324</b>	<b>359</b>	<b>393</b>	<b>428</b>	<b>462</b>	<b>506</b>
<b>Zone 2</b>	<b>219</b>	<b>242</b>	<b>271</b>	<b>302</b>	<b>329</b>	<b>364</b>	<b>399</b>	<b>434</b>	<b>469</b>	<b>514</b>
<b>Zone 3</b>	<b>222</b>	<b>245</b>	<b>275</b>	<b>307</b>	<b>334</b>	<b>370</b>	<b>405</b>	<b>441</b>	<b>476</b>	<b>521</b>

Cubic Ft: 2.6

Ship Weight: 6

## Tack Board 14" High For 60" Overhead **HWTB1460** 57.25" X 0.5" X 14"



- Fully tackable surface
- Choose any fabric
- Quick Ship in QS fabrics
- Not installed (shipped separate)
- Use with Vitality, Elevation, Atlas and Hyperwork

57.25" X 0.5" X 14"

Freight Class: 100

Grade	1	2	3	4	5	6	7	8	9	10
<b>Zone 1</b>	<b>216</b>	<b>238</b>	<b>267</b>	<b>298</b>	<b>324</b>	<b>359</b>	<b>393</b>	<b>428</b>	<b>462</b>	<b>506</b>
<b>Zone 2</b>	<b>219</b>	<b>242</b>	<b>271</b>	<b>302</b>	<b>329</b>	<b>364</b>	<b>399</b>	<b>434</b>	<b>469</b>	<b>514</b>
<b>Zone 3</b>	<b>222</b>	<b>245</b>	<b>275</b>	<b>307</b>	<b>334</b>	<b>370</b>	<b>405</b>	<b>441</b>	<b>476</b>	<b>521</b>

Cubic Ft: 2.6

Ship Weight: 6

## Tack Board 14" High For 54" Overhead **HWTB1454** 51.25" X 0.5" X 14"



- Fully tackable surface
- Choose any fabric
- Quick Ship in QS fabrics
- Not installed (shipped separate)
- Use with Vitality, Elevation, Atlas and Hyperwork

51.25" X 0.5" X 14"

Freight Class: 100

Grade	1	2	3	4	5	6	7	8	9	10
<b>Zone 1</b>	<b>216</b>	<b>238</b>	<b>267</b>	<b>298</b>	<b>324</b>	<b>359</b>	<b>393</b>	<b>428</b>	<b>462</b>	<b>506</b>
<b>Zone 2</b>	<b>219</b>	<b>242</b>	<b>271</b>	<b>302</b>	<b>329</b>	<b>364</b>	<b>399</b>	<b>434</b>	<b>469</b>	<b>514</b>
<b>Zone 3</b>	<b>222</b>	<b>245</b>	<b>275</b>	<b>307</b>	<b>334</b>	<b>370</b>	<b>405</b>	<b>441</b>	<b>476</b>	<b>521</b>

Cubic Ft: 2.6

Ship Weight: 6

# SIN 711-2 WORKSURFACE ACCESSORIES

## Tack Board 14" High For 48" Overhead **HWTB1448** 45.25" X 0.5" X 14"



- Fully tackable surface
- Choose any fabric
- Quick Ship in QS fabrics
- Not installed (shipped separate)
- Use with Vitality, Elevation, Atlas, Hyperwork and Bravo

Grade	1	2	3	4	5	6	7	8	9	10
<b>Zone 1</b>	192	211	240	262	285	314	344	374	403	440
<b>Zone 2</b>	195	214	244	266	289	319	349	380	409	447
<b>Zone 3</b>	198	217	247	270	294	323	354	385	415	453

45.25" X 0.5" X 14"

Freight Class: 100

Cubic Ft: 2.6

Ship Weight: 6

## Tack Board 14" High For 42" Overhead **HWTB1442** 39.25" X 0.5" X 14"

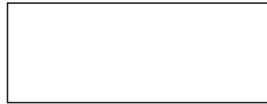

- Fully tackable surface
- Choose any fabric
- Quick Ship in QS fabrics
- Not installed (shipped separate)
- Use with Vitality, Elevation, Atlas and Hyperwork

Grade	1	2	3	4	5	6	7	8	9	10
<b>Zone 1</b>	192	211	240	262	285	314	344	374	403	440
<b>Zone 2</b>	195	214	244	266	289	319	349	380	409	447
<b>Zone 3</b>	198	217	247	270	294	323	354	385	415	453

39.25" X 0.5" X 14"

Freight Class: 100

Cubic Ft: 2.6

Ship Weight: 6

## Tack Board 14" High For 36" Overhead **HWTB1436** 33.25" X 0.5" X 14"



- Fully tackable surface
- Choose any fabric
- Quick Ship in QS fabrics
- Not installed (shipped separate)
- Use with Vitality, Elevation, Atlas and Hyperwork

Grade	1	2	3	4	5	6	7	8	9	10
<b>Zone 1</b>	192	211	240	262	285	314	344	374	403	440
<b>Zone 2</b>	195	214	244	266	289	319	349	380	409	447
<b>Zone 3</b>	198	217	247	270	294	323	354	385	415	453

33.25" X 0.5" X 14"

Freight Class: 100

Cubic Ft: 2.6

Ship Weight: 6

## Tack Board 14" High For 30" Overhead **HWTB1430** 27.25" X 0.5" X 14"



- Fully tackable surface
- Choose any fabric
- Quick Ship in QS fabrics
- Not installed (shipped separate)
- Use with Vitality, Elevation, Atlas and Hyperwork

Grade	1	2	3	4	5	6	7	8	9	10
<b>Zone 1</b>	192	211	240	262	285	314	344	374	403	440
<b>Zone 2</b>	195	214	244	266	289	319	349	380	409	447
<b>Zone 3</b>	198	217	247	270	294	323	354	385	415	453

27.25" X 0.5" X 14"

Freight Class: 100

Cubic Ft: 2.6

Ship Weight: 6

## Tack Board 14" High For Corner Hutch Return **HWTB1424** 21.25" X 0.5" X 14"



- Fabric covered tack boards
- Choose any fabric
- Quick Ship in QS fabrics
- Not installed (shipped separate)
- Fits Hyperwork corner hutch returns

Grade	1	2	3	4	5	6	7	8	9	10
<b>Zone 1</b>	192	211	240	262	285	314	344	374	403	440
<b>Zone 2</b>	195	214	244	266	289	319	349	380	409	447
<b>Zone 3</b>	198	217	247	270	294	323	354	385	415	453

21.25" X 0.5" X 14"

Freight Class: 100

Cubic Ft: 2.6

Ship Weight: 6

# WORKSURFACE ACCESSORIES SIN 711-2

## Tack Board 7" High For 72" Overhead

**HWTB772**

**69.25" X 0.5" X 7"**



- Fully tackable surface
- Choose any fabric
- Quick Ship in QS fabrics
- Not installed (shipped separate)
- Use with Vitality, Elevation, Atlas and Hyperwork

Grade	1	2	3	4	5	6	7	8	9	10
Zone 1	192	211	240	262	285	314	344	374	403	440
Zone 2	195	214	244	266	289	319	349	380	409	447
Zone 3	198	217	247	270	294	323	354	385	415	453

69.25" X 0.5" X 7"

Freight Class: 100

Cubic Ft: 1.25

Ship Weight: 3

## Tack Board 7" High For 66" Overhead

**HWTB766**

**63.25" X 0.5" X 7"**



- Fully tackable surface
- Choose any fabric
- Quick Ship in QS fabrics
- Not installed (shipped separate)
- Use with Vitality, Elevation, Atlas and Hyperwork

Grade	1	2	3	4	5	6	7	8	9	10
Zone 1	192	211	240	262	285	314	344	374	403	440
Zone 2	195	214	244	266	289	319	349	380	409	447
Zone 3	198	217	247	270	294	323	354	385	415	453

63.25" X 0.5" X 7"

Freight Class: 100

Cubic Ft: 1.25

Ship Weight: 3

## Tack Board 7" High For 60" Overhead

**HWTB760**

**57.25" X 0.5" X 7"**



- Fully tackable surface
- Choose any fabric
- Quick Ship in QS fabrics
- Not installed (shipped separate)
- Use with Vitality, Elevation, Atlas and Hyperwork

Grade	1	2	3	4	5	6	7	8	9	10
Zone 1	192	211	240	262	285	314	344	374	403	440
Zone 2	195	214	244	266	289	319	349	380	409	447
Zone 3	198	217	247	270	294	323	354	385	415	453

57.25" X 0.5" X 7"

Freight Class: 100

Cubic Ft: 1.25

Ship Weight: 3

## TB2500 Tack Board

**TB2500**

**68.25" X 0.75" X 12.75"**



- Fully tackable surface
- Choose any fabric
- Quick Ship in QS fabrics
- Not installed (shipped separate)
- Use with Forte CVC727

Grade	1	2	3	4	5	6	7	8	9	10
Zone 1	178	198	227	248	271	300	330	360	389	426
Zone 2	181	201	230	252	275	305	335	365	395	432
Zone 3	183	204	234	255	279	309	340	371	401	439

68.25" X 0.75" X 12.75"

Freight Class: 100

Cubic Ft: 2

Ship Weight: 6

## Tack Board 64" or 66" Overheads

**TBBP62**

**61.25" X 0.5" X 12.75"**



- Fully tackable surface
- Choose any fabric
- Quick Ship in QS fabrics
- Not installed (shipped separate)
- Use with FR\_2278, BP\_617, BP\_677, TR\_3077 and WY\_677

Grade	1	2	3	4	5	6	7	8	9	10
Zone 1	178	198	227	248	271	300	330	360	389	426
Zone 2	181	201	230	252	275	305	335	365	395	432
Zone 3	183	204	234	255	279	309	340	371	401	439

61.25" X 0.5" X 12.75"

Freight Class: 100

Cubic Ft: 2

Ship Weight: 6



# SIN 711-2 WORKSURFACE ACCESSORIES

## Tack Board for 70" Overheads

**TBBP70**

**67.25" X 0.5" X 12.75"**



- Fully tackable surface
- Choose any fabric
- Quick Ship in QS fabrics
- Not installed (shipped separate)
- Use with FR\_2280, BP\_717, BP\_737, WY\_717 and WY\_737

67.25" X 0.5" X 12.75"  
Freight Class: 100

Grade	1	2	3	4	5	6	7	8	9	10
<b>Zone 1</b>	178	198	227	248	271	300	330	360	389	426
<b>Zone 2</b>	181	201	230	252	275	305	335	365	395	432
<b>Zone 3</b>	183	204	234	255	279	309	340	371	401	439

Cubic Ft: 2.5  
Ship Weight: 6

## Tack Board for Bedford 72" Overheads

**TBBF70**

**67.5" X 0.5" X 14"**



- Fully tackable surface
- Choose any fabric
- Quick Ship in QS fabrics
- Not installed (shipped separate)
- Use with Bedford TR\_3071 overhead storage

67.5" X 0.5" X 14"  
Freight Class: 100

Grade	1	2	3	4	5	6	7	8	9	10
<b>Zone 1</b>	178	198	227	248	271	300	330	360	389	426
<b>Zone 2</b>	181	201	230	252	275	305	335	365	395	432
<b>Zone 3</b>	183	204	234	255	279	309	340	371	401	439

Cubic Ft: 3  
Ship Weight: 7

## Tack Board for 57.75" Overheads

**TBBP55**

**55" X 0.5" X 12.75"**



- Fully tackable surface
- Choose any fabric
- Quick Ship in QS fabrics
- Not installed (shipped separate)
- Fits BP\_675 and FR\_2268 overheads

55" X 0.5" X 12.75"  
Freight Class: 100

Grade	1	2	3	4	5	6	7	8	9	10
<b>Zone 1</b>	178	198	227	248	271	300	330	360	389	426
<b>Zone 2</b>	181	201	230	252	275	305	335	365	395	432
<b>Zone 3</b>	183	204	234	255	279	309	340	371	401	439

Cubic Ft: 2.6  
Ship Weight: 6

## Tack Board for Legacy 72" Overhead

**LVTB1472**

**37.25" X 0.5" X 14"**



- Fully tackable surface
- Choose any fabric
- Quick Ship in QS fabrics
- Not installed (shipped separate)
- Use with Legacy LVM727 overhead storage

37.25" X 0.5" X 14"  
Freight Class: 100

Grade	1	2	3	4	5	6	7	8	9	10
<b>Zone 1</b>	178	198	227	248	271	300	330	360	389	426
<b>Zone 2</b>	181	201	230	252	275	305	335	365	395	432
<b>Zone 3</b>	183	204	234	255	279	309	340	371	401	439

Cubic Ft: 2.6  
Ship Weight: 6

## Accessory Wall

### Accessory Wall 14" High

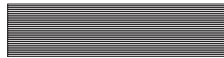

- Six channels for accessory attachment
- Black color
- Field installed
- AW1472 fits 72" Overhead
- AW1466 fits 66" Overhead
- AW1460 fits 60" Overhead

Freight Class: 100

### Accessory Wall 7" High



- Three channels for accessory attachment
- Black color
- Field installed
- AW772 fits 72" Overhead
- AW766 fits 66" Overhead
- AW760 fits 60" Overhead

Freight Class: 100

Zone Pricing	1	2	3
--------------	---	---	---

<b>AW1472</b>	69.25" X 0.5" X 14"	Cubic Ft: 2.6 Ship Weight: 15	<b>193</b>	<b>196</b>	<b>199</b>
<b>AW1466</b>	63.25" X 0.5" X 14"	Cubic Ft: 2.6 Ship Weight: 15	<b>193</b>	<b>196</b>	<b>199</b>
<b>AW1460</b>	57.25" X 0.5" X 14"	Cubic Ft: 2.6 Ship Weight: 15	<b>193</b>	<b>196</b>	<b>199</b>

<b>AW772</b>	69.25" X 0.5" X 7"	Cubic Ft: 1.3 Ship Weight: 10	<b>97</b>	<b>98</b>	<b>100</b>
<b>AW766</b>	63.25" X 0.5" X 7"	Cubic Ft: 1.3 Ship Weight: 10	<b>97</b>	<b>98</b>	<b>100</b>
<b>AW760</b>	57.25" X 0.5" X 7"	Cubic Ft: 1.3 Ship Weight: 10	<b>97</b>	<b>98</b>	<b>100</b>

ACCESSORIES

# WORKSURFACE ACCESSORIES SIN 711-2

## Personal Organization

Zone Pricing

1

2

3

### Pen Holder



- Stores up to 24 pencils
- 4 lb. capacity
- 4" X 3.5" X 4"

<b>MD1000</b>	<b>QS</b>	4" X 3.5" X 4"	<b>15</b>	<b>15</b>	<b>15</b>
---------------	-----------	----------------	-----------	-----------	-----------

Freight Class: 100

### CD Holder



- Stores 10 CDs within easy reach
- 4 lb. capacity
- 7" X 5.5" X 2"

<b>MD1001</b>	<b>QS</b>	7" X 5.5" X 2"	<b>24</b>	<b>24</b>	<b>25</b>
---------------	-----------	----------------	-----------	-----------	-----------

Freight Class: 100

### File Holder



- Stores files horizontally
- 10 lb. capacity
- 1" X 8.5" X 2"

<b>MD1002</b>	<b>QS</b>	1" X 8.5" X 2"	<b>15</b>	<b>15</b>	<b>15</b>
---------------	-----------	----------------	-----------	-----------	-----------

Freight Class: 100

### Paper Tray Letter Size



- Stores letter size sheets
- 5 lb. capacity
- 9.5" X 14" X 2"

<b>MD1003</b>	<b>QS</b>	9.5" X 14" X 2"	<b>46</b>	<b>47</b>	<b>47</b>
---------------	-----------	-----------------	-----------	-----------	-----------

Freight Class: 100

### Accessory Tray



- Stores notepads, Post-its, pens etc.
- 5 lb. capacity
- 10" X 9.5" X 2"

<b>MD1004</b>	<b>QS</b>	10" X 9.5" X 2"	<b>31</b>	<b>31</b>	<b>32</b>
---------------	-----------	-----------------	-----------	-----------	-----------

Freight Class: 100

### Phone Base



- 5 lb. capacity
- 8.5" X 9.5" X 2"

<b>MD1005</b>	<b>QS</b>	8.5" X 9.5" X 2"	<b>37</b>	<b>38</b>	<b>38</b>
---------------	-----------	------------------	-----------	-----------	-----------

Freight Class: 100

### Paper Tray Legal Size



- Stores legal size sheets
- 7 lb. capacity
- 15" X 10.5" X 2"

<b>MD1007</b>	<b>QS</b>	15" X 10.5" X 2"	<b>46</b>	<b>47</b>	<b>47</b>
---------------	-----------	------------------	-----------	-----------	-----------

Freight Class: 100

# SIN 711-2 WORKSURFACE ACCESSORIES

## Folder Tray



- Stores files vertically
- 10 lb. capacity
- 7" X 12.5" X 8"

Freight Class: 100

Zone Pricing

1

2

3

<b>MD1008 QS</b>	7" X 12.5" X 8"	<b>53</b>	<b>54</b>	<b>55</b>
------------------	-----------------	-----------	-----------	-----------

## Binder Holder



- Stores binders, phone books, etc.
- 10 lb. capacity
- 5" X 9" X 10.5"
- Requires 14" high accessory wall

Freight Class: 100

<b>MD1009 QS</b>	5" X 9" X 10.5"	<b>24</b>	<b>24</b>	<b>25</b>
------------------	-----------------	-----------	-----------	-----------

## Cup Holder



- Holds cans, coffee cups, etc.
- 4 lb. capacity
- 4" X 5" X 2"

Freight Class: 100

<b>MD1014 QS</b>	4" X 5" X 2"	<b>15</b>	<b>15</b>	<b>15</b>
------------------	--------------	-----------	-----------	-----------

## Shelves



- 18" Shelf - 15 lb. capacity
- 24" Shelf - 15 lb. capacity
- 30" Shelf - 18 lb. capacity
- 36" Shelf - 25 lb. capacity

Freight Class: 100

<b>MDSHELF18 QS</b>	18" X 7" X 2"	<b>90</b>	<b>91</b>	<b>93</b>
<b>MDSHELF24 QS</b>	24" X 7" X 2"	<b>113</b>	<b>115</b>	<b>116</b>
<b>MDSHELF30 QS</b>	30" X 7" X 2"	<b>128</b>	<b>130</b>	<b>132</b>
<b>MDSHELF36 QS</b>	36" X 7" X 2"	<b>149</b>	<b>151</b>	<b>153</b>

ACCESSORIES

# WORKCENTER SIN 711-2

TOP BASE FINISHES  
 ASPEN **AP** | NATURAL MAPLE **FM** |  
 WINDSOR CHERRY **WC** | MAHOGANY **M** |

BASE ONLY FINISHES  
 GRAPHITE **GP** | GREY **G** | ESPRESSO **X** |  
 MEDIUM OAK **O** | PEARWOOD **PW** | BLACK **E** |  
 CLASSIC CHERRY **CC** |

**Workcenter** is comprised of modular cabinets and tops to create your ideal work space. Each cabinet features a heavy-duty wood storage drawer. Complete access to the rear of the drawer is provided due to full extension ball-bearing drawer slides.

The upper storage area includes one fixed shelf and one adjustable shelf. This storage area is concealed by two doors attached with smooth action, adjustable European-style hinges. A 10" overhang is standard on all top surfaces.

Cabinets are 36" wide and 20" deep and available in 11 laminate finishes. Tops are 1-1/2" thick with durable, fluted 3mm PVC edgebanding in four woodgrain finishes. Four door/drawer pull styles are also available.

**Workcenter** modular cabinets must be arranged back-to-back with a 10" overhang on all four sides. They can also be arranged side-by-side to accommodate larger areas.



## Workcenter Storage Cabinet Module



Freight Class: 125

- Storage behind two doors
- One adjustable shelf behind doors
- Full-width storage drawer in bottom
- Optional filing hardware available for field installation
- Arrange cabinets back-to-back and side-to-side to create workcenter utilizing tops below

## 46" x 60" Workcenter Top

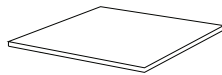

Freight Class: 70

- 1.5" thick Atlas top available in four woodgrain finishes
- 3mm PVC edge banding, fluted on working sides
- Use two 46" x 60" tops to fit four back-to-back and side-by-side cabinets to create 42" counter height worksurface

## 56" x 60" Workcenter Top



Freight Class: 70

- 1.5" thick Atlas top available in four woodgrain finishes
- 3mm PVC edge banding, fluted on working sides
- Use one 56" x 60" tops to fit two back-to-back cabinets to create 42" counter height worksurface with a 10" overhang

## 64" x 60" Workcenter Top



Freight Class: 70

- 1.5" thick Atlas top available in four woodgrain finishes
- 3mm PVC edge banding, fluted on working sides
- Use two 64" x 60" tops to fit six back-to-back and side-by-side cabinets to create 42" counter height worksurface with a 10" overhang

## 82" x 60" Workcenter Top

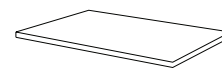

Freight Class: 70

- 1.5" thick Atlas top available in four woodgrain finishes
- 3mm PVC edge banding, fluted on working sides
- Use two 82" x 60" tops to fit eight back-to-back and side-by-side cabinets to create 42" counter height worksurface with a 10" overhang

Zone Pricing	1	2	3
--------------	---	---	---

**P\_\_ 42STOR** 36" X 20" X 40.5" Cubic Ft: 22.7 Ship Weight: 174 **1938** **1967** **1996**

**Pulls:** Bright Brass **PB** | Brushed Chrome **PW** | Ebony **PE** | Oval Nickel **PD**

**PA1\_T4660** 46" X 60" X 1.5" Cubic Ft: 11.1 Ship Weight: 140 **1159** **1176** **1194**

**PA1\_T5660** 56" X 60" X 1.5" Cubic Ft: 10.7 Ship Weight: 170 **1229** **1247** **1266**

**PA1\_T6460** 64" X 60" X 1.5" Cubic Ft: 17 Ship Weight: 210 **1268** **1287** **1306**

**PA1\_T8260** 82" X 60" X 1.5" Cubic Ft: 19 Ship Weight: 232 **1387** **1408** **1429**

The **Milan Bistro Table** collection is the perfect solution for break rooms, cafeterias, dining areas and anywhere that you need a place to meet and eat. A large variety of top options designed to coordinate with other HPFI furnishings. Combine any table top with a 28" high or 40.75" high heavy-duty steel base to create an ideal environment. Choose from a wide range of Milan Bistro Seating for an instant lunch area or sidewalk café.

**CHARACTERISTICS**

**TOPS:**

- **Vacuformed** tops are 1" thick encapsulated vinyl surface with soft radius edge for optimum comfort on the wrists. 36" or 42" diameter round tops are available in Bisque (BQ) or White (WH)
- **Atlas** tops are 1½" thick thermally fused laminate with matching 3 millimeter PVC AdvantEdge banding. 36" or 42" diameter round tops are available in Natural Maple (FM), Windsor Cherry (WC), Mahogany (M) or Aspen (AP)
- **Hyperwork** tops are 1⅛" thick thermally fused laminate with matching 3 millimeter PVC AdvantEdge banding. 36" or 42" diameter round tops are available in Natural Maple (FM), Windsor Cherry (WC), Mahogany (M), Graphite (GP), Medium Oak (O), Aspen (AP), Espresso (X), Black (E) Grey (G) or Classic Cherry (CC)

**BASES:**

- 28" high steel base column is 3" in diameter supported by a 30" diameter heavy-duty metal disc base with easy adjustable leveling glides. Overall table height with top is 29"-29½".
- 40¾" high steel base column is 3" in diameter with foot ring for bistro height seating. Column and foot ring supported by a 30" diameter heavy-duty metal disc base with easy adjustable leveling glides. Overall table height with top is 41¾"-42½".



**ASSEMBLY**

Simple assembly is required to connect table tops to bases with a screwdriver. All necessary attaching hardware is provided.

**MILAN SEATING**

All chair feature black metal frames with solid wood seat and back in a dark Mahogany finish.

**Three styles of seating**

- Guest chairs with 18" high seat
- Bistro chairs with 30" high seat
- Bistro swivel chairs with 30" high seat

You can order an upholstered seat for any model. Upholstery will add 1" to the seat height. Each version is available with a choice of ladder back, porthole back or wavy back.

All Milan chairs ship fully assembled.

**MILAN TABLES**

**Table Base for 42" High Table**

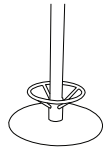

- 40.75" high steel base
- Foot ring for bistro height seating
- 30" heavy duty disk base
- 3" diameter steel column
- Easy attachment to Milan table tops

Freight Class: 250

**Table Base for 29" High Table**

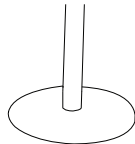

- 28" high steel base for round table
- 30" heavy duty disk base
- 3" diameter steel column
- Easy attachment to Milan table tops

Freight Class: 250

		Zone Pricing	1	2	3
<b>BTR536TB</b>	30" X 30" X 40.75" Cubic Ft: 30 Ship Weight: 90		<b>657</b>	<b>667</b>	<b>677</b>
<b>BTR534TB</b>	30" X 30" X 28" Cubic Ft: 21 Ship Weight: 70		<b>484</b>	<b>491</b>	<b>499</b>

# BREAKROOM MILAN

SIN 71-308

How To Order

BT BQ R36T

Finish

Zone Pricing

1

2

3

## Vacuformed Table Top



- 1" thick top with encapsulated vinyl surface
- Easy attachment to Milan table bases
- Tops feature soft radius edge for optimum comfort
- Available in Bisque (BQ) or White (WH)

Freight Class: 85

<b>BT_R36T</b>	36" X 36" X 1"	Cubic Ft: 3	Ship Weight: 44	<b>751</b>	<b>762</b>	<b>774</b>
<b>BT_R42T</b>	42" X 42" X 1"	Cubic Ft: 4	Ship Weight: 56	<b>800</b>	<b>812</b>	<b>825</b>

## Round Atlas Table Top



- 1.5" thick round table top for Milan table bases
- Thermally fused laminate top
- Easy attachment to Milan table bases
- 3 millimeter PVC AdvantEdge banding
- Tops available in Aspen (AP), Natural Maple (FM), Windsor Cherry (WC) and Mahogany (M)

Freight Class: 85

<b>A1_R36T</b>	36" X 36" X 1.5"	Cubic Ft: 3.6	Ship Weight: 59	<b>503</b>	<b>510</b>	<b>518</b>
<b>A1_R42T</b>	42" X 42" X 1.5"	Cubic Ft: 4.7	Ship Weight: 75	<b>598</b>	<b>607</b>	<b>616</b>

## Round Hyperwork Table Top



- 1.125" thick round table top for Milan table bases
- Thermally fused laminate top
- Easy attachment to Milan table bases
- 3 millimeter PVC AdvantEdge banding
- Tops available in Hyperwork finishes: Mahogany (M), Windsor Cherry (WC), Aspen (AP), Espresso (X), Natural Maple (FM), Medium Oak (O), Classic Cherry (CC), Graphite (GP), Grey (G) and Black (E)

Freight Class: 85

<b>H_R36T</b>	36" X 36" X 1.125"	Cubic Ft: 3	Ship Weight: 44	<b>453</b>	<b>460</b>	<b>467</b>
<b>H_R42T</b>	42" X 42" X 1.125"	Cubic Ft: 4	Ship Weight: 56	<b>539</b>	<b>547</b>	<b>555</b>

## MILAN CHAIRS Ladder Back Wood

### 213 Chair, Ladder Back and Wood Seat



- Ladder style back with wood seat
- Commercial grade hardwood seat and back
- Mahogany stain finish
- Non-marring floor glides
- Ships two chairs per carton, price is per chair
- Seat: 16"W X 16.5"D X 17.25"H

FREIGHT CLASS: 250  
CUBIT FT: 11.0  
SHIP WT: 38

16.75" W X 21" D X 32" H	St. Yardage: n/a	<b>264</b>	<b>268</b>	<b>272</b>
--------------------------	------------------	------------	------------	------------

### 216 Bistro Chair, Ladder Back and Wood Seat



- Ladder style back with wood seat
- Commercial grade hardwood seat and back
- Mahogany stain finish
- Non-marring floor glides
- Seat: 16"W X 16.5"D X 30"H

FREIGHT CLASS: 250  
CUBIT FT: 11.0  
SHIP WT: 31

17" W X 20" D X 42" H	St. Yardage: n/a	<b>361</b>	<b>366</b>	<b>372</b>
-----------------------	------------------	------------	------------	------------

MEETING & BREAKROOM



SIN 71-308 **BREAKROOM MILAN**

		Zone Pricing	1	2	3
<b>217 Bistro Swivel Chair, Ladder Back and Wood Seat</b>  <ul style="list-style-type: none"> <li>• Ladder style back and swivel wood seat</li> <li>• Seat swivels 360 degrees</li> <li>• Commercial grade hardwood seat and back</li> <li>• Mahogany stain finish</li> <li>• Non-marring floor glides</li> <li>• Seat: 16"W X16.5"D X 30.25"H</li> </ul> <p>FREIGHT CLASS: 250 CUBIT FT: 11.0 SHIP WT: 32</p>	18" W X 19" D X 44.5" H	St. Yardage: n/a	<b>361</b>	<b>366</b>	<b>372</b>

**MILAN CHAIRS Porthole Back Wood**

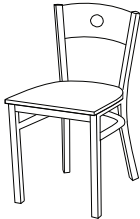
<b>223 Chair, Porthole Back and Wood Seat</b>  <ul style="list-style-type: none"> <li>• Chair with porthole back</li> <li>• Commercial grade hardwood seat and back</li> <li>• Mahogany stain finish</li> <li>• Non-marring floor glides</li> <li>• Ships two chairs per carton, price is per chair</li> <li>• Seat: 16.25"W X16.5"D X 17.25"H</li> </ul> <p>FREIGHT CLASS: 250 CUBIT FT: 11.0 SHIP WT: 38</p>	16.5" W X 21" D X 32.5" H	St. Yardage: n/a	<b>264</b>	<b>268</b>	<b>272</b>
---	---------------------------	------------------	------------	------------	------------

<b>222 Bistro Chair, Porthole Back and Wood Seat</b>  <ul style="list-style-type: none"> <li>• Bistro chair with porthole back</li> <li>• Commercial grade hardwood seat and back</li> <li>• Mahogany stain finish</li> <li>• Non-marring floor glides</li> <li>• Seat: 16"W X16.5"D X 30"H</li> </ul> <p>FREIGHT CLASS: 250 CUBIT FT: 11.0 SHIP WT: 27</p>	16.75" W X 20" D X 42.75" H	St. Yardage: n/a	<b>361</b>	<b>366</b>	<b>372</b>
---	-----------------------------	------------------	------------	------------	------------

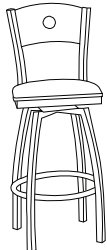
<b>226 Bistro Swivel Chair, Porthole Back and Wood Seat</b>  <ul style="list-style-type: none"> <li>• Bistro swivel chair with porthole back</li> <li>• Seat swivels 360 degrees</li> <li>• Commercial grade hardwood seat and back</li> <li>• Mahogany stain finish</li> <li>• Non-marring floor glides</li> <li>• Seat: 16"W X16.5"D X 30.5"H</li> </ul> <p>FREIGHT CLASS: 250 CUBIT FT: 11.0 SHIP WT: 31</p>	17.75" W X 18.75" D X 45.75" H	St. Yardage: n/a	<b>361</b>	<b>366</b>	<b>372</b>
---	--------------------------------	------------------	------------	------------	------------

MEETING & BREAKROOM

# BREAKROOM MILAN SIN 71-308

## MILAN CHAIRS Wavy Back Wood

Zone Pricing

1

2

3

### 233 Chair, Wavy Back and Wood Seat

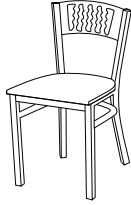

- Chair with wavy back
- Commercial grade hardwood seat and back
- Mahogany stain finish
- Non-marring floor glides
- Ships two chairs per carton, price is per chair
- Seat: 16.25"W X 16.5"D X 17.25"H

FREIGHT CLASS: 250  
CUBIT FT: 11.0  
SHIP WT: 38

18" W X 21" D X 32.5" H

St. Yardage: n/a

264

268

272

### 228 Bistro Chair, Wavy Back and Wood Seat



- Bistro chair with wavy back
- Commercial grade hardwood seat and back
- Mahogany stain finish
- Non-marring floor glides
- Seat: 16"W X 16.5"D X 30"H

FREIGHT CLASS: 250  
CUBIT FT: 11.0  
SHIP WT: 31

17" W X 20" D X 42.75" H

St. Yardage: n/a

361

366

372

### 229 Bistro Swivel Chair, Wavy Back and Wood Seat



- Bistro chair with wavy back
- Seat swivels 360 degrees
- Commercial grade hardwood seat and back
- Mahogany stain finish
- Non-marring floor glides
- Seat: 16"W X 16.5"D X 30"H

FREIGHT CLASS: 250  
CUBIT FT: 11.0  
SHIP WT: 31

17.75" W X 19.5" D X 45.25" H

St. Yardage: n/a

361

366

372

## MILAN CHAIRS Ladder Back Upholstered

### 213U Chair, Ladder Back and Upholstered Seat



Freight Class: 250  
Cubic Ft: 11  
Ship Weight: 38

16.75" W X 21" D X 32" H

St. Yardage: 0.75

Grade	1	2	3	4	5	6	7	8	9	10	L	LL
Zone 1	347	362	379	392	406	424	443	462	481	504	562	654
Zone 2	352	367	385	398	412	430	450	469	488	512	570	664
Zone 3	357	373	390	404	418	437	456	476	495	519	579	674

- Ladder style back with upholstered seat
- Commercial grade hardwood back and seat pan
- Mahogany stain finish

- Non-marring floor glides
- Ships two chairs per carton, price is per chair
- Seat: 16.5" W X 17"D X 18.5" H

# SIN 71-308 BREAKROOM MILAN

## 216U Bistro Chair, Ladder Back and Upholstered Seat

17" W X 20" D X 42" H

St. Yardage: 0.75



Freight Class: 250  
Cubic Ft: 11  
Ship Weight: 31

Grade	1	2	3	4	5	6	7	8	9	10	L	LL
Zone 1	444	459	476	489	503	521	540	559	578	601	659	751
Zone 2	451	466	483	496	511	529	548	567	587	610	669	762
Zone 3	457	473	490	504	518	537	556	576	595	619	679	774

- Ladder style back with upholstered seat
- Commercial grade hardwood back and seat pan
- Mahogany stain finish
- Non-marring floor glides
- Seat: 16.25" W X 17"D X 31" H

## 217U Bistro Swivel Chair, Ladder Back and Upholstered Seat

18" W X 20" D X 44.5" H

St. Yardage: 0.75



Freight Class: 250  
Cubic Ft: 11  
Ship Weight: 32

Grade	1	2	3	4	5	6	7	8	9	10	L	LL
Zone 1	444	459	476	489	503	521	540	559	578	601	659	751
Zone 2	451	466	483	496	511	529	548	567	587	610	669	762
Zone 3	457	473	490	504	518	537	556	576	595	619	679	774

- Ladder style back with upholstered swivel seat
- Seat swivels 360 degrees
- Commercial grade hardwood back and seat pan
- Mahogany stain finish
- Non-marring floor glides
- Seat: 16.25" W X 17"D X 31.25" H

## MILAN CHAIRS Porthole Back Upholstered

### 223U Chair, Porthole Back and Upholstered Seat

16.5" W X 21" D X 32.5" H

St. Yardage: 0.75



Freight Class: 250  
Cubic Ft: 11  
Ship Weight: 38

Grade	1	2	3	4	5	6	7	8	9	10	L	LL
Zone 1	347	362	379	392	406	424	443	462	481	504	562	654
Zone 2	352	367	385	398	412	430	450	469	488	512	570	664
Zone 3	357	373	390	404	418	437	456	476	495	519	579	674

- Chair with porthole back
- Upholstered seat
- Commercial grade hardwood back and seat pan
- Mahogany stain finish
- Ships two chairs per carton, price is per chair
- Non-marring floor glides
- Seat: 16.5" W X 17"D X 18.5" H

### 222U Bistro Chair, Porthole Back and Upholstered Seat

16.75" W X 20" D X 42.75" H

St. Yardage: 0.75



Freight Class: 250  
Cubic Ft: 11  
Ship Weight: 27

Grade	1	2	3	4	5	6	7	8	9	10	L	LL
Zone 1	444	459	476	489	503	521	540	559	578	601	659	751
Zone 2	451	466	483	496	511	529	548	567	587	610	669	762
Zone 3	457	473	490	504	518	537	556	576	595	619	679	774

- Bistro chair with porthole back
- Upholstered seat
- Commercial grade hardwood back and seat pan
- Mahogany stain finish
- Non-marring floor glides
- Seat: 16.5" W X 17"D X 31.25" H

# BREAKROOM MILAN SIN 71-308

## 226U Bistro Swivel Chair, Porthole Back and Upholstered Seat

17.75" W X 18.75" D X 45.25" H St. Yardage: 0.75



Freight Class: 250  
Cubic Ft: 11  
Ship Weight: 31

Grade	1	2	3	4	5	6	7	8	9	10	L	LL
Zone 1	444	459	476	489	503	521	540	559	578	601	659	751
Zone 2	451	466	483	496	511	529	548	567	587	610	669	762
Zone 3	457	473	490	504	518	537	556	576	595	619	679	774

- Bistro swivel chair with porthole back
- Seat swivels 360 degrees
- Upholstered seat
- Mahogany stain finish
- Non-marring floor glides
- Seat: 16.5" W X 17" D X 31.75" H

## MILAN CHAIRS Wavy Back Upholstered

### 233U Chair, Wavy Back and Upholstered Seat

18" W X 21" D X 33" H St. Yardage: 0.75

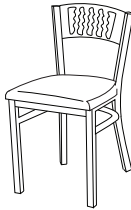

Freight Class: 250  
Cubic Ft: 11  
Ship Weight: 38

Grade	1	2	3	4	5	6	7	8	9	10	L	LL
Zone 1	347	362	379	392	406	424	443	462	481	504	562	654
Zone 2	352	367	385	398	412	430	450	469	488	512	570	664
Zone 3	357	373	390	404	418	437	456	476	495	519	579	674

- Chair with wavy back
- Upholstered seat
- Commercial grade hardwood back and seat pan
- Mahogany stain finish
- Non-marring floor glides
- Ships two chairs per carton, price is per chair
- Seat: 16.5" W X 17" D X 18" H

### 228U Bistro Chair, Wavy Back and Upholstered Seat

17.75" W X 19.5" D X 42.75" H St. Yardage: 0.75



Freight Class: 250  
Cubic Ft: 11  
Ship Weight: 31

Grade	1	2	3	4	5	6	7	8	9	10	L	LL
Zone 1	444	459	476	489	503	521	540	559	578	601	659	751
Zone 2	451	466	483	496	511	529	548	567	587	610	669	762
Zone 3	457	473	490	504	518	537	556	576	595	619	679	774

- Bistro chair with wavy back
- Upholstered seat
- Commercial grade hardwood back and seat pan
- Mahogany stain finish
- Non-marring floor glides
- Seat: 16.5" W X 17" D X 31.25" H

### 229U Bistro Swivel Chair, Wavy Back and Upholstered Seat

17.75" W X 19.5" D X 45.25" H St. Yardage: 0.75



Freight Class: 250  
Cubic Ft: 11  
Ship Weight: 31

Grade	1	2	3	4	5	6	7	8	9	10	L	LL
Zone 1	444	459	476	489	503	521	540	559	578	601	659	751
Zone 2	451	466	483	496	511	529	548	567	587	610	669	762
Zone 3	457	473	490	504	518	537	556	576	595	619	679	774

- Bistro swivel chair with wavy back
- Seat swivels 360 degrees
- Upholstered seat
- Commercial grade hardwood back and seat pan
- Mahogany stain finish
- Non-marring floor glides
- Seat: 16.5" W X 17" D X 31.75" H

**Mobile. Versatile. Comfortable.**

Combining the comfort of lounge seating with the high functionality of team seating, **Genesis Team Seating** is a new alternative for innovative environments.



1737 Genesis with casters

**Genesis Details**

- Dual-wheel, easy-rolling casters for mobility
- Unique 360-degree revolving shaped tablet for note-taking or laptop support
- Tablet easily relocates on left or right arm
- Storage compartment under seat
- Standard black finish arms and tablet
- Fabric combinations available with seat/back differing from arm panels

**Additional Options**

- Storage drawer with upholstered front
- Wood finish arms and tablet
- Cup holder secures mugs, drink cans, etc.
- Document holder supports work materials from training manuals to large-size textbooks
- Newspaper Holder accommodates papers, magazines and up to 10 training binders

STANDARD ORDER: SPECIFICATION DETAIL

**1727D**

**WC**

**808**

**952**

Base Model

Finish Code

Seat/Back Fabric

Arm Fabric, (if different from Seat/Back fabric)

**Please Note:** If a Two-Color Fabric Combination is desired, add **\$53 upcharge** to the highest fabric price grade selected.

**Genesis Team**

**1727 Team Chair**

27" W X 26" D X 32" H

St. Yardage: 5.5 (Seat & Back 3, Arms 2.5)



Freight Class: 125  
Cubic Ft: 19  
Ship Weight: 85

Grade	1	2	3	4	5	6	7	8	9	10	L	LL
<b>Zone 1</b>	1656	1832	1986	2079	2181	2316	2369	2588	2724	2894	3771	3981
<b>Zone 2</b>	1681	1859	2016	2110	2214	2351	2405	2627	2765	2937	3828	4041
<b>Zone 3</b>	1706	1887	2046	2141	2246	2385	2440	2666	2806	2981	3884	4100

- Open storage area under seat 22" x 18" x 10" supports up to 15 lb. evenly distributed
- Black arm caps, tablet arm and shelf
- 16.5" x 10.75" tablet arm
- Mounted on casters for mobility
- Seat: 21"W X 20"D X 18.5"H

OPTION	PRICE	CODE
Self-Locking Casters	85.00	S

**QS**

**1727D Team Chair**

27" W X 26" D X 32" H

St. Yardage: 5.5 (Seat & Back 3, Arms 2.5)



Freight Class: 125  
Cubic Ft: 19  
Ship Weight: 92

Grade	1	2	3	4	5	6	7	8	9	10	L	LL
<b>Zone 1</b>	1826	2020	2187	2323	2425	2560	2613	2832	2968	3138	4119	4225
<b>Zone 2</b>	1853	2050	2220	2358	2461	2598	2652	2874	3013	3185	4181	4288
<b>Zone 3</b>	1881	2081	2253	2393	2498	2637	2691	2917	3057	3232	4243	4352

- Storage drawer with full-extension slides and upholstered front
- Drawer interior 16.25" x 17" x 5.5"
- Black arms caps and tablet arm
- 16.5" x 10.75" Tablet arm supports up to 15 lb. evenly distributed
- Mounted on casters for mobility
- Seat: 21"W X 20"D X 18.5"H

OPTION	PRICE	CODE
Self-Locking Casters	85.00	S

**QS**

# GENESIS SIN 711-18

## FINISH SELECTION

PEARWOOD **PW** | ROUGE MAHOGANY **RM** | MAHOGANY **MAH** | ASPEN **AP** | NATURAL **FM** | HONEY CHERRY **HCY** | ESPRESSO **ESP** | MOAB **MOB** | WALNUT **WAL** | WINDSOR CHERRY **WC** | CLASSIC CHERRY **CCY** |

MEETING & BREAKROOM

### 1737 Team Chair

27" W X 26" D X 32" H

St. Yardage: 5.5 (Seat & Back 3, Arms 2.5)



Freight Class: 125  
Cubic Ft: 19  
Ship Weight: 85

Grade	1	2	3	4	5	6	7	8	9	10	L	LL
<b>Zone 1</b>	1828	2004	2160	2301	2403	2538	2591	2810	2946	3116	3941	4203
<b>Zone 2</b>	1855	2034	2192	2336	2439	2576	2630	2852	2990	3163	4000	4266
<b>Zone 3</b>	1883	2064	2225	2370	2475	2614	2669	2894	3034	3209	4059	4329

- Open storage area under seat 22" x 18" x 10"
- Solid wood arm caps, tablet arm and shelf (specify finish)
- Mounted on casters for mobility
- 16.5" x 10.75" tablet arm supports up to 15 lb. evenly distributed
- Seat: 21" W X 20" D X 18.5" H

OPTION	PRICE	CODE
Self-Locking Casters	85.00	S

QS

### 1737D Team Chair

27" W X 26" D X 32" H

St. Yardage: 5.5 (Seat & Back 3, Arms 2.5)



Freight Class: 125  
Cubic Ft: 19  
Ship Weight: 92

Grade	1	2	3	4	5	6	7	8	9	10	L	LL
<b>Zone 1</b>	2004	2195	2365	2523	2625	2760	2813	3032	3168	3338	4287	4425
<b>Zone 2</b>	2034	2228	2400	2561	2664	2801	2855	3077	3216	3388	4351	4491
<b>Zone 3</b>	2064	2261	2436	2599	2704	2843	2897	3123	3236	3428	4416	4558

- Storage drawer with full extension slides and upholstered front
- Drawer interior 16.25" x 17" x 5.5"
- Solid wood arm caps and tablet arm (specify finish)
- Mounted on casters for mobility
- 16.5" x 10.75" tablet arm supports up to 15 lb. evenly distributed
- Seat: 21" W X 20" D X 18.5" H

OPTION	PRICE	CODE
Self-Locking Casters	85.00	S

QS

### CH Cup Holder

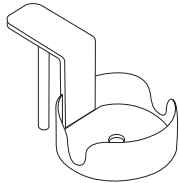

- Holds cans, coffee mugs, etc.
- Interior diameter 3-7/8"
- Heavy gauge steel
- Black powder coated finish
- Easily relocates to right or left arm
- Can ship via ground service

FREIGHT CLASS: 70  
CUBIT FT: 1  
SHIP WT: 1

4" W X 7" D X 3" H

St. Yardage: n/a

Zone Pricing	1	2	3
	182	185	187

QS

### DH Document Holder

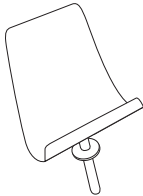

- Holds papers, training manuals, books, etc
- Angled for proper positioning of material
- Heavy gauge steel
- Black powder coated finish
- Easily relocates to right or left arm
- Can ship via ground service

FREIGHT CLASS: 70  
CUBIT FT: 1  
SHIP WT: 3

9.75" W X 3" D X 10.5" H

St. Yardage: n/a

170	173	175
-----	-----	-----

QS

### NH Newspaper Holder

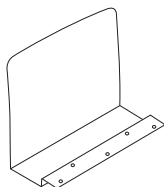

- Holds newspapers and magazines
- Positioned 1" from arm panel to hold up to 1" binder
- Heavy gauge steel
- Black powder coated finish
- Mounts under storage shelf
- Can ship via ground service

FREIGHT CLASS: 70  
CUBIT FT: 1  
SHIP WT: 5

14" W X 7" D X 11.5" H

St. Yardage: n/a

83	84	85
----	----	----

QS



**A Study in Simplicity**

The **Stax Collection** is at home in waiting areas, cafeterias or any other high-traffic area. Features include durable propylene seat and back integrated with rigid steel legs and support structure.



**Upholstered Stax 723SBC**

**Stax Details**

- Choice of chrome or black finish legs
- Seat and/or back cushions may be custom upholstered in a wide variety of stock or COM fabrics
- Seat connectors available for easy ganging configurations
- Rolling stack cart holds up to 24 non-upholstered Stax chairs



**724 Stax**



**Shipping Information**

- Ships four per carton (single carton quantities available for an upcharge)



**Cart shown with 720 Stax chair**

**Please Note:** Orders for Stax chairs in less than multiples of four(4) will incur a broken carton charge of \$27 per order.

Stax		Zone Pricing	1	2	3									
<b>723 Black Wire Stacking Chair</b>	20.5" W X 21.5" D X 31.5" H St. Yardage: n/a		<b>139</b>	<b>141</b>	<b>143</b>									
	<ul style="list-style-type: none"> <li>• Black 510/WG solid steel wire rod with durable black powder coat finish</li> <li>• Comfortably shaped black polypropylene seat and back</li> <li>• Easily stacks out of the way when not in use</li> <li>• Can stack up to 24 high</li> <li>• Ships four to a carton, price is per chair</li> <li>• Seat: 18"W X 16.5"D X 18.5"H</li> </ul>		Single Pack Specifications: Freight Class: 400 Cubes: 10 Ship Weight: 19											
Freight Class: 150 Cubic Ft: 11.0 Ship Weight: 55														
<b>724 Chrome Wire Stacking Chair</b>	20.5" W X 21.5" D X 31.5" H St. Yardage: n/a		<b>139</b>	<b>141</b>	<b>143</b>									
	<ul style="list-style-type: none"> <li>• 510/WG solid steel wire rod with durable chrome finish</li> <li>• Comfortably shaped black polypropylene seat and back</li> <li>• Easily stacks out of the way when not in use</li> <li>• Can stack up to 24 high</li> <li>• Ships four to a carton, price is per chair</li> <li>• Seat: 18"W x 16.5"D x 18.5"H</li> </ul>		Single Pack Specifications: Freight Class: 400 Cubes: 10 Ship Weight: 19											
Freight Class: 150 Cubic Ft: 11.0 Ship Weight: 55														
<b>723SC Black Wire Upholstered Seat</b>	20.5" W X 21.5" D X 31.5" H St. Yardage: 0.75													
	<ul style="list-style-type: none"> <li>• Same features as 723 except:</li> <li>• Upholstered seat cushion</li> <li>• Can stack up to 12 high</li> <li>• Seat 18"W x 16.5"D x 19"H</li> </ul>		Single Pack Specifications: Freight Class: 400 Cubes: 10 Ship Weight: 19											
Freight Class: 150 Cubic Ft: 11.0 Ship Weight: 55														
		<b>Grade</b>	<b>1</b>	<b>2</b>	<b>3</b>	<b>4</b>	<b>5</b>	<b>6</b>	<b>7</b>	<b>8</b>	<b>9</b>	<b>10</b>	<b>L</b>	<b>LL</b>
		<b>Zone 1</b>	<b>192</b>	<b>200</b>	<b>208</b>	<b>215</b>	<b>223</b>	<b>233</b>	<b>243</b>	<b>253</b>	<b>262</b>	<b>275</b>	<b>300</b>	<b>354</b>
		<b>Zone 2</b>	<b>195</b>	<b>203</b>	<b>211</b>	<b>218</b>	<b>226</b>	<b>236</b>	<b>247</b>	<b>257</b>	<b>266</b>	<b>279</b>	<b>305</b>	<b>359</b>
		<b>Zone 3</b>	<b>198</b>	<b>206</b>	<b>214</b>	<b>221</b>	<b>230</b>	<b>240</b>	<b>250</b>	<b>261</b>	<b>270</b>	<b>283</b>	<b>309</b>	<b>365</b>

### 723BC Black Wire Upholstered Back

20.5" W X 21.5" D X 31.5" H St. Yardage: 0.5



Freight Class: 150  
Cubic Ft: 11.0  
Ship Weight: 55

**QS**

Grade	1	2	3	4	5	6	7	8	9	10	L	LL
<b>Zone 1</b>	192	200	208	215	223	233	243	253	262	275	300	354
<b>Zone 2</b>	195	203	211	218	226	236	247	257	266	279	305	359
<b>Zone 3</b>	198	206	214	221	230	240	250	261	270	283	309	365

- Same features as above except:
- Upholstered back cushion
- Seat: 18"W x 16.5"D x 18.5"H

Single Pack Specifications:  
Freight Class: 400  
Cubes: 10  
Ship Weight: 19

### 723SBC Black Wire Upholstered Seat/Back

20.5" W X 21.5" D X 31.5" H St. Yardage: 0.75



Freight Class: 150  
Cubic Ft: 11.0  
Ship Weight: 55

**QS**

Grade	1	2	3	4	5	6	7	8	9	10	L	LL
<b>Zone 1</b>	244	252	260	276	303	321	340	359	378	401	435	445
<b>Zone 2</b>	248	256	264	280	308	326	345	364	384	407	442	452
<b>Zone 3</b>	251	260	268	284	312	331	350	370	389	413	448	458

- Same features as above except:
- Upholstered seat/back cushion
- Seat: 18"W x 16.5"D x 19"H

Single Pack Specifications:  
Freight Class: 400  
Cubes: 10  
Ship Weight: 19

### 724SC Chrome Wire Upholstered Seat

20.5" W X 21.5" D X 31.5" H St. Yardage: 0.75



Freight Class: 150  
Cubic Ft: 11.0  
Ship Weight: 55

**QS**

Grade	1	2	3	4	5	6	7	8	9	10	L	LL
<b>Zone 1</b>	192	200	208	215	223	233	243	253	262	275	300	354
<b>Zone 2</b>	195	203	211	218	226	236	247	257	266	279	305	359
<b>Zone 3</b>	198	206	214	221	230	240	250	261	270	283	309	365

- Same features as 724 except:
- Upholstered seat cushion
- Can stack up to 12 high
- Seat: 18"W x 16.5"D x 19"H

Single Pack Specifications:  
Freight Class: 400  
Cubes: 10  
Ship Weight: 19

### 724BC Chrome Wire Upholstered Back

20.5" W X 21.5" D X 31.5" H St. Yardage: 0.75

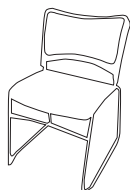

Freight Class: 150  
Cubic Ft: 11.0  
Ship Weight: 55

**QS**

Grade	1	2	3	4	5	6	7	8	9	10	L	LL
<b>Zone 1</b>	192	200	208	215	223	233	243	253	262	275	300	354
<b>Zone 2</b>	195	203	211	218	226	236	247	257	266	279	305	359
<b>Zone 3</b>	198	206	214	221	230	240	250	261	270	283	309	365

- 510/WG solid steel wire rod with chrome finish
- Comfortably shaped black polypropylene seat and back
- Upholstered back cushion match front
- Easily stacks out of the way when not in use
- Can stack up to 12 high
- Ships four to a carton, price is per chair
- Seat: 18"W x 16.5"D x 18.5"H

Single Pack Specifications:  
Freight Class: 400  
Cubes: 10  
Ship Weight: 19

### 724SBC Chrome Wire Upholstered Seat/Back

20.5" W X 21.5" D X 31.5" H St. Yardage: 0.75



Freight Class: 150  
Cubic Ft: 11.0  
Ship Weight: 55

**QS**

Grade	1	2	3	4	5	6	7	8	9	10	L	LL
<b>Zone 1</b>	244	252	260	276	303	321	340	359	378	401	435	445
<b>Zone 2</b>	248	256	264	280	308	326	345	364	384	407	442	452
<b>Zone 3</b>	251	260	268	284	312	331	350	370	389	413	448	458

- Same features as 724SC except:
- Upholstered seat/back cushion

Single Pack Specifications:  
Freight Class: 400  
Cubes: 10  
Ship Weight: 19

**720-GC Seat Connector**

1.5" W X 0.75" D X 0.5" H

St. Yardage: n/a

Zone Pricing

1

2

3

81

82

83

- Bag of 50 poly seat connectors

Freight Class: 70

Cubic Ft: 0.2

**QS** Ship Weight: 1

**720-CART Stax Cart**

24" W X 22" D X 20.5" H

St. Yardage: n/a

245

249

252



- Black 510/WG solid steel wire rod with durable black powder coat finish
- Casters for easy mobility
- Holds up to 24 non-upholstered wire stacking chairs or 20 upholstered wire stacking chairs

Freight Class: 150

Cubic Ft: 11.0

**QS** Ship Weight: 55

# INCOGNITO OTTOMAN SIN 711-18

## FINISH SELECTION

NATURAL **FM** | WINDSOR CHERRY **WC** | MAHOGANY **M** |  
 GRAPHITE **GP** | MEDIUM OAK **O** | ASPEN **AP** | PEARWOOD **PW** |  
 BLACK **E** | ESPRESSO **X** | GREY **G** | CLASSIC CHERRY **CC** |

MEETING & BREAKROOM

### Work Anywhere

You never know when or where inspiration will strike, so when it does you may need to get to work in a hurry.

Our **Incognito** convertible ottoman/desk pops open at a moment's notice to provide a convenient, comfortable and stable work surface ready for legal pads, laptops, lunch and more.



1900 Ottoman with desk top extended

### Incognito Details

- Serves as an ottoman, additional seating and a mobile work station
- Convenient storage space in base
- Four hidden casters for effortless mobility
- Extremely stable desk surface due to counterbalancing ottoman top
- Work surface height is optimized for laptop use, paperwork, meals and more
- Desk top auto-locks securely when opened and is easily closed using the one hand safety releases

### Additional Information

- Work surface available in 11 finishes
- Hundreds of upholstery selections available

#### STANDARD ORDER: SPECIFICATION DETAIL

**1900**

**WC**

**808**

Base Model

Finish Code

Fabric Selection

## Incognito Ottoman/Desk

### 1900\_ Convertible Ottoman Desk

23.5" W X 21.5" D X 18" H

St. Yardage: 2.25

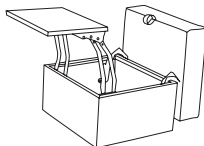

Grade	1	2	3	4	5	6	7	8	9	10	L	LL
Zone 1	1109	1147	1186	1215	1248	1292	1337	1381	1426	1481	1628	1837
Zone 2	1126	1164	1204	1233	1267	1311	1357	1402	1447	1503	1652	1865
Zone 3	1142	1181	1222	1251	1285	1331	1377	1422	1469	1525	1677	1892

- Dimensions shown are for closed desk
- Ottoman that doubles as a mobile work station
- Work surface: 18.5"W x 14"D x 26.75"H from floor locks in place
- Hidden casters for mobility
- Storage in ottoman base
- Work surface available in all Hyperwork finishes listed above
- Specify finish

OPTION	PRICE	CODE
Self-locking Casters	85.00	S

Freight Class: 150

Cubic Ft: 9.0

Ship Weight: 63

**QS**

**TOP FINISHES**

ASPEN **AP** | NATURAL MAPLE **FM** | GRAPHITE **GP** | MAHOGANY **M** | MEDIUM OAK **O** | ESPRESSO **X** | GREY **G** | WINDSOR CHERRY **WC** | CLASSIC CHERRY **CC** |

**LEG COLORS**

DOVE GREY **G** | BLACK **E** |

**CHARACTERISTICS**

Fixed leg training tables provide maximum flexibility, versatility and a modern aesthetic, multiple shapes and sizes allow for almost unlimited configurations.

- 1 1/8" thermal fused laminate tops are offered in a broad nine-color palette with matching 3mm edge banding
- High pressure laminate tops with matching or black edge available for a 15% upcharge. A six-week lead time will apply (see Top Type)
- 2" fixed metal legs available in **Black** or **Dove Grey**
- Each unit includes **4 leg adjusters** and **4 casters**--2 locking for maximum flexibility
- Table height of 30" using adjusters and 31 1/8" using casters
- Optional modesty panel (for rectangular tables only) available in finishes listed
- Some assembly required

**CLIQUE ITEM NUMBER FORMAT**

ItemNumber-  
Top Type-  
Top Color-  
Leg Style (always 1)-

**Leg Color**

Item Number Example:  
**CT4824RC 1 M 1 E**

**TOP SHAPE**

- RC** Rectangular
- H** Half Round
- T** Trapezoid
- C** Crescent
- RD** Round (X-base Tables)
- SQ** Square (X-base Tables)

**TOP TYPE**

- 1** 1 1/8" Thermally fused laminate with matching 3mm edge band with soft radius edges.
- 2** 1 1/8" High pressure laminate with black FB flat standard. 15% upcharge. Available only in **Mahogany, Medium Oak, Grey** and **Windsor Cherry**.
- 4** 1 1/8" High pressure laminate top with matching 3mm edge with soft radius corners. 15% upcharge. Available only in **Mahogany, Medium Oak, Grey** and **Windsor Cherry**.

**LEG STYLE**

- 1** 2" straight (All Clique)

**LEG COLOR**

- E** Black
- G** Dove Grey

**TOP FINISH OPTIONS**

- FM** Natural Maple
- WC** Windsor Cherry\*
- M** Mahogany\*
- GP** Graphite
- O** Medium Oak\*
- G** Grey\*
- X** Espresso
- AP** Aspen
- CC** Classic Cherry

*\*Available in high pressure laminate tops*



**QUICKSHIP**

Quick Ship is not available on any items ordered with option.

**CARE AND CLEANING INSTRUCTIONS**

**Normal cleaning:** Clean using a soft cloth and a good window cleaner which contains no ammonia, followed by wiping dry using a dry soft cloth.

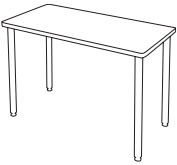
**Specifications subject to change without notice.**

Training Tables		Zone Pricing	1	2	3
<b>Rectangular Training Table</b>					
 <ul style="list-style-type: none"> <li>• 24" deep</li> <li>• Rectangular top</li> <li>• Four fixed legs</li> <li>• Easy assembly required</li> </ul>	<b>CT4824RC__1_</b> 48" X 24" X 30" Cubic Ft: 5.8 Ship Weight: 67	<b>420</b>	<b>426</b>	<b>433</b>	
	<b>CT6024RC__1_</b> 60" X 24" X 30" Cubic Ft: 6.3 Ship Weight: 76	<b>472</b>	<b>479</b>	<b>486</b>	
	<b>CT7224RC__1_</b> 72" X 24" X 30" Cubic Ft: 7.6 Ship Weight: 89	<b>519</b>	<b>527</b>	<b>535</b>	
	Freight Class: 100				
<b>Rectangular Training Table</b>					
 <ul style="list-style-type: none"> <li>• 30" deep</li> <li>• Rectangular top</li> <li>• Four fixed legs</li> <li>• Easy assembly required</li> </ul>	<b>CT_4830RC__1_</b> 48" X 30" X 30" Cubic Ft: 6.2 Ship Weight: 80	<b>532</b>	<b>540</b>	<b>548</b>	
	<b>CT_6030RC__1_</b> 60" X 30" X 30" Cubic Ft: 8.5 Ship Weight: 98	<b>584</b>	<b>593</b>	<b>602</b>	
	<b>CT_7230RC__1_</b> 72" X 30" X 30" Cubic Ft: 10 Ship Weight: 112	<b>649</b>	<b>659</b>	<b>668</b>	
	Freight Class: 100				
<b>Half Round Table</b>					
 <ul style="list-style-type: none"> <li>• Half circle top</li> <li>• Three fixed legs</li> <li>• Easy assembly required</li> </ul>	<b>CT4824H__1_</b> 48" X 24" X 30" Cubic Ft: 5.8 Ship Weight: 67	<b>593</b>	<b>602</b>	<b>611</b>	
	Freight Class: 100				

MEETING & BREAKROOM



### Crescent Table



- Crescent top
- Four fixed legs
- Easy assembly required

Freight Class: 100

	Zone Pricing	1	2	3
<b>CT6724C_ _1_</b> 67" X 24" X 30" Cubic Ft: 8.5 Ship Weight: 85		<b>705</b>	<b>716</b>	<b>726</b>

### Trapezoid Table

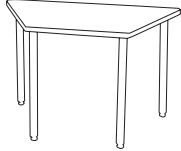

- Trapezoid top
- Four fixed legs
- Easy assembly required

Freight Class: 100

<b>CT4824T_ _1_</b> 48" X 24" X 30" Cubic Ft: 5.8 Ship Weight: 67		<b>593</b>	<b>602</b>	<b>611</b>
---	--	------------	------------	------------

## Table Accessories

### Optional Modesty Panels (for rectangular tables only)



- Modesty panel (for rectangular tables only)
- Available in laminate finishes listed above
- Installation required

Freight Class: 85

<b>CT48RCMOD_</b> 48" X 12" Cubic Ft: 4.0 Ship Weight: 45		<b>201</b>	<b>204</b>	<b>207</b>
<b>CT60RCMOD_</b> 58" X 12" Cubic Ft: 4.0 Ship Weight: 52		<b>235</b>	<b>239</b>	<b>242</b>
<b>CT72RCMOD_</b> 72" X 12" Cubic Ft: 4.2 Ship Weight: 59		<b>256</b>	<b>260</b>	<b>264</b>

### Optional Table Joining Plate

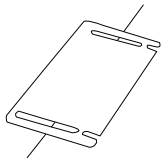

- Table joining plate
- Installation required

Freight Class: 85

<b>CTJP</b> Cubic Ft: 0.5 Ship Weight: 1.5		<b>43</b>	<b>44</b>	<b>44</b>
--	--	-----------	-----------	-----------

## X-Base Tables

### Round Table with X base



- Black X-base only
- Easy assembly required
- No casters

Freight Class: 150

<b>CT36RD_ _</b> 36" X 36" X 30.5" Cubic Ft: 14.6 Ship Weight: 62		<b>615</b>	<b>624</b>	<b>633</b>
<b>CT42RD_ _</b> 42" X 42" X 30.5" Cubic Ft: 14.8 Ship Weight: 74		<b>716</b>	<b>727</b>	<b>737</b>
<b>CT48RD_ _</b> 48" X 48" X 30.5" Cubic Ft: 16 Ship Weight: 85		<b>819</b>	<b>831</b>	<b>844</b>

### Square Table with X Base



- Black X-base only
- Easy assembly required
- No casters

Freight Class: 150

<b>CT36SQ_ _</b> 36" X 36" X 30.5" Cubic Ft: 14.6 Ship Weight: 65		<b>615</b>	<b>624</b>	<b>633</b>
<b>CT42SQ_ _</b> 42" X 42" X 30.5" Cubic Ft: 14.8 Ship Weight: 78		<b>716</b>	<b>727</b>	<b>737</b>





### CHARACTERISTICS

Deflection tables feature a tilting top that allows tables to be nested for ease of movement and compact storage. Pull them out and set up when needed, tuck them away when the meeting is over.

- Tilt-top feature
- 1½" thermal fused laminate tops are offered in a broad nine-color palette with matching 3mm edge banding
- High pressure laminate tops with matching or black edge available for a 15% upcharge. A six-week lead time will apply
- Metal T-legs legs available in **Black** or **Dove Grey**
- Includes **4 casters**--2 locking
- Table height of 30"
- Available in 48", 60" or 72" widths with a choice of 24" or 30" depth
- Color coordinated modesty panel is standard
- Some assembly required

### CLIQUE ITEM NUMBER FORMAT

ItemNumber-  
 Top Type-  
 Top Color-  
 Leg Style (always 2)-  
 Leg Color

*Item Number Example:*

### DT4824RC 1 M 2 E

#### TOP SHAPE

RC Rectangular

#### TOP TYPE

- 1 1½" Thermally fused laminate with matching 3mm edge band with soft radius edges.
- 2 1½" High pressure laminate with black FB flat standard. 15% upcharge. Available only in **Mahogany, Medium Oak, Grey** and **Windsor Cherry**.
- 4 1½" High pressure laminate top with matching 3mm edge with soft radius corners. 15% upcharge. Available only in **Mahogany, Medium Oak, Grey** and **Windsor Cherry**.

#### LEG STYLE

2 T-leg tilt top

#### LEG COLOR

E Black  
 G Dove Grey

### TOP FINISH OPTIONS

- FM Natural Maple
- WC Windsor Cherry\*
- M Mahogany\*
- GP Graphite
- O Medium Oak\*
- G Grey\*
- X Espresso
- AP Aspen
- CC Classic Cherry

*\*Available in high pressure laminate tops*



### QUICKSHIP

Quick Ship is not available on any items ordered with option.

### CARE AND CLEANING INSTRUCTIONS

**Normal cleaning:** Clean using a soft cloth and a good window cleaner which contains no ammonia, followed by wiping dry using a dry soft cloth.

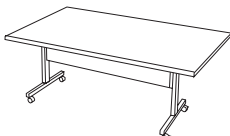
**Specifications subject to change without notice.**

	Zone Pricing	1	2	3
<b>Tilt-Top Training Tables</b>				
<b>Rectangular Tilt-Top Training Table</b>				
 <ul style="list-style-type: none"> <li>• 24" Deep folding rectangular table</li> <li>• Metal T-legs available in Black or Dove Grey</li> <li>• Includes 4 casters, 2 locking</li> <li>• Assembly required</li> </ul>	DT4824RC_ <u>2</u> 48" X 24" X 30" Cubic Ft: 7 Ship Weight: 87	<b>605</b>	<b>614</b>	<b>623</b>
	DT6024RC_ <u>2</u> 60" X 24" X 30" Cubic Ft: 9.4 Ship Weight: 102	<b>667</b>	<b>677</b>	<b>687</b>
	DT7224RC_ <u>2</u> 72" X 24" X 30" Cubic Ft: 11.3 Ship Weight: 116	<b>705</b>	<b>716</b>	<b>726</b>
Freight Class: 100				
<b>Rectangular Tilt-Top Training Table</b>				
 <ul style="list-style-type: none"> <li>• 30" Deep folding rectangular table</li> <li>• Metal T-legs available in Black or Dove Grey</li> <li>• Includes 4 casters, 2 locking</li> <li>• Assembly required</li> </ul>	DT4830RC_ <u>2</u> 48" X 30" X 30" Cubic Ft: 9.4 Ship Weight: 110	<b>628</b>	<b>637</b>	<b>647</b>
	DT6030RC_ <u>2</u> 60" X 30" X 30" Cubic Ft: 11.4 Ship Weight: 120	<b>690</b>	<b>700</b>	<b>711</b>
	DT7230RC_ <u>2</u> 72" X 30" X 30" Cubic Ft: 13.6 Ship Weight: 132	<b>739</b>	<b>750</b>	<b>761</b>
Freight Class: 100				

# FORTE TABLES SIN 711-9

FINISH SELECTION  
HONEY CHERRY C |

## ASSEMBLY

Tables ship with top and base in separate cartons. Assembly is quick and easy by attaching bases to tops with bolts provided.

## OPTION

Pre-installed Plug-N-Play power/data/phone outlet available. See Conference Accessories for details and pricing.

**Quick Ship is not available on any items ordered with option.**

## PACKING

All units are properly packed in heavy duty cartons with heavy duty corner pads. All packaging conforms to or exceeds specifications as outlined in the Uniform Freight Classification.

## PALLETIZATION

See Page 3.

**Specifications subject to change without notice.**

## CONTEMPORARY VENEER

- Contemporary Design
- 1<sup>3</sup>/<sub>16</sub>" thick tops with Solid Hardwood Edge
- Multiple-Ply Cherry Veneer
- Full-Fill, Catalyzed Lacquer finish

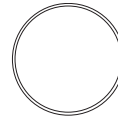

**48" Round**  
Freight Class 85



**72" Rectangular**  
Freight Class 70



**96" Rectangular**  
Freight Class 70

## Veneer Bases

Veneer tables feature Straight Leg and X Bases surfaced in veneer with full-fill, catalyzed lacquer finish.

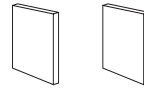

**Straight Leg**  
32" x 1<sup>1</sup>/<sub>4</sub>" x 27<sup>1</sup>/<sub>2</sub>"  
Freight Class 70  
(ships with top)



**X Base**  
29<sup>3</sup>/<sub>4</sub>" x 28"  
Freight Class 150

## Contemporary Veneer

### Round Veneer Conference Table



- Forte wood veneer top and X base with full-fill, catalyzed lacquer finish
- Honey Cherry finish
- Concave edge profile
- Ships in two cartons
- Assembly Required

		Zone Pricing		
		1	2	3
<b>CVCTR48</b>	<b>QS</b> 48" X 48" X 29" Cubic Ft: 50.1 Ship Weight: 96	<b>1592</b>	<b>1616</b>	<b>1640</b>

### Rectangular Veneer Conference Table

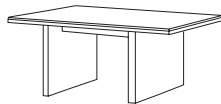

- Forte wood veneer top and legs with full-fill, catalyzed lacquer finish
- Honey Cherry finish
- Concave solid hardwood edge profile
- Ships in one carton
- Some assembly required

<b>CVCT72</b>	<b>QS</b> 72" X 36" X 29" Cubic Ft: 9.2 Ship Weight: 142	<b>2187</b>	<b>2220</b>	<b>2253</b>
---------------	--	-------------	-------------	-------------

### Rectangular Veneer Conference Table



- Forte wood veneer top and legs with full-fill, catalyzed lacquer finish
- Honey Cherry finish
- Concave solid hardwood edge profile
- Ships in one carton
- Some assembly required

<b>CVCT96</b>	<b>QS</b> 96" X 42" X 29" Cubic Ft: 12.2 Ship Weight: 190	<b>3161</b>	<b>3208</b>	<b>3256</b>
---------------	---	-------------	-------------	-------------

**ASSEMBLY**

Tables ship with top and base in separate cartons. Assembly is quick and easy by attaching bases to tops with bolts provided.

**OPTION**

Pre-installed Plug-N-Play power/data/phone outlet available. See Conference Accessories for details and pricing.

**Quick Ship is not available on any items ordered with options.**

**PACKING**

All units are properly packed in heavy duty cartons with heavy duty corner pads. All packaging conforms to or exceeds specifications as outlined in the Uniform Freight Classification.

**PALLETIZATION**

See Page 3.

**Specifications subject to change without notice.**

**TRADITIONAL VENEER** (Page<?>)

- Traditional Design
- 13/16" thick tops with Solid Hardwood Edge
- Multiple-Ply Cherry Veneer with Rouge Mahogany finish
- Full-Fill, Catalyzed Lacquer finish
- Work surface dimensions will vary due to edge profile treatment



**36" Round  
42" Round  
48" Round  
Freight Class 85**

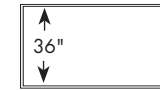

**72" Rectangular  
Freight Class 92.5**

**Straight Veneer Bases**

Veneer tables feature Straight Leg surfaced in veneer with full-fill, catalyzed lacquer finish.

**Wood Pedestal Bases**

Queen Anne Style Bases are carved wood pedestal base. Four fluted feet with brass foot caps.

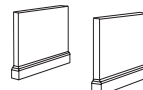

**Straight Leg  
Traditional  
26" x 1 1/8" x 27 1/2"  
31 1/2" x 1 1/8" x 27 3/4"  
Freight Class 85**

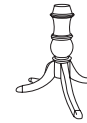

**Queen Anne Style  
4-Footed Pedestal  
34 3/4" x 28 1/2"  
Freight Class 300**

**Traditional Veneer**

Zone Pricing

1

2

3

**Traditional Round 4-Footed Pedestal**

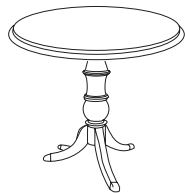

- 1-3/16" thick top, wood edge
- Rouge Mahogany finish
- Queen Anne style pedestal base with fluted legs, brass leg caps
- Ships in two cartons, assembly required
- LVMTR48 - 45" worksurface, veneer top
- LPMTR48 - 46.25" worksurface, HPL top
- LPMTR42 - 40.25" worksurface, HPL top
- LPMTR36 - 34.25" worksurface, HPL top

Model	Top	Dimensions	Cubic Ft.	Ship Weight	Zone 1	Zone 2	Zone 3
<b>LVMTR48 QS</b>	48" X 30"	48" X 30"	20.0	105	<b>1709</b>	<b>1735</b>	<b>1760</b>
<b>LPMTR48</b>	48" X 30"	48" X 30"	20.0	105	<b>1709</b>	<b>1735</b>	<b>1760</b>
<b>LPMTR42</b>	42" X 30"	42" X 30"	18.8	97	<b>1554</b>	<b>1577</b>	<b>1601</b>
<b>LPMT36</b>	36" X 30"	36" X 30"	18.6	73	<b>1205</b>	<b>1223</b>	<b>1241</b>

**Rectangular Conference Table**

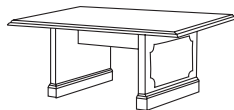

- Straight legs with traditional style base molding
- Rouge Mahogany finish
- Ships in one carton, assembly required
- LPM - HPL top
- LVM - Wood veneer top
- DX - Deluxe picture frame molding

Model	Top	Dimensions	Cubic Ft.	Ship Weight	Zone 1	Zone 2	Zone 3
<b>LVMT72 QS</b>	72" X 36" X 30"	72" X 36" X 30"	14.3	165	<b>2454</b>	<b>2491</b>	<b>2528</b>
<b>LVMT72DX QS</b>	72" X 36" X 30"	72" X 36" X 30"	14.3	165	<b>2547</b>	<b>2585</b>	<b>2623</b>
<b>LPMT72</b>	72" X 36" X 30"	72" X 36" X 30"	14.3	165	<b>2454</b>	<b>2491</b>	<b>2528</b>
<b>LPMT72DX</b>	72" X 36" X 30"	72" X 36" X 30"	14.3	165	<b>2547</b>	<b>2585</b>	<b>2623</b>

Shown with (DX) deluxe, picture-frame molding

# VITALITY TABLES SIN 711-9

FINISH SELECTION  
MOHOGANY M | WINDSOR CHERRY WC

## ASSEMBLY

Tables ship with top and base in separate cartons. Assembly is quick and easy by attaching bases to tops with bolts provided.

## OPTION

Pre-installed Plug-N-Play power/data/phone outlet available. See Conference Accessories for details and pricing.

**Quick Ship is not available on any items ordered with option.**

## PACKING

All units are properly packed in heavy duty cartons with heavy duty corner pads. All packaging conforms to or exceeds specifications as outlined in the Uniform Freight Classification.

## PALLETIZATION

See Page 3.

**Specifications subject to change without notice.**

## TRANSITIONAL LAMINATE

- Transitional Design
- 1<sup>3</sup>/<sub>16</sub>" thick tops with Solid Hardwood Edge
- High-Gloss, High Pressure Laminate surface



**Vitality Series Edge Detail**

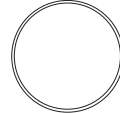

**42" Round  
48" Round**  
Freight Class 85



**72" Rectangular**  
Freight Class 100



**96" Rectangular**  
Freight Class 92.5



**Rectangular Two-Piece Top**  
**120" 144"**  
Freight Class 92.5

## TABLE BASES

Straight Leg, Square and X Bases are 1" thick thermally fused laminate; traditional design features hardwood base molding. Curved bases are hardboard panel on frame construction surfaced in high pressure laminate.

Freight Class is same for 2 or 3 piece bases.



**Curved Legs**  
**32"x3 3/4"x27 1/2"**  
Freight Class 100



**X Base**  
**29 3/4"x28"**  
Freight Class 150

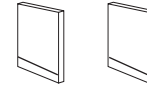

**Straight Leg Traditional**  
**23 3/4"x1 1/8"x26"**  
Freight Class 85



**Cylinder Base**  
**18"x27 3/4"**  
**22"x27 3/4"**  
Freight Class 92.5

## Transitional Laminate

Zone Pricing	1	2	3
--------------	---	---	---

### Transitional Round with Cylinder Base

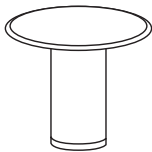

- Vitality design
- High-gloss, HPL top
- Solid hardwood edge
- Sturdy cylinder base
- Ships in two cartons, assembly required

<b>V_ TR42C</b>	42" X 29"	Cubic Ft: 11.6	Ship Weight: 150	<b>1855</b>	<b>1883</b>	<b>1911</b>
<b>V_ TR48C</b>	48" X 29"	Cubic Ft: 12.8	Ship Weight: 162	<b>2021</b>	<b>2051</b>	<b>2082</b>
<b>V_ TR36C</b>	36" X 29"	Cubic Ft: 10.7	Ship Weight: 126	<b>1565</b>	<b>1588</b>	<b>1612</b>

### Transitional Round with X-Base



- Vitality design
- High-gloss, HPL top
- Solid hardwood edge
- Sturdy X-style base
- Ships in two cartons, assembly required

<b>V_ TR42X</b>	42" X 29"	Cubic Ft: 14.8	Ship Weight: 100	<b>1129</b>	<b>1146</b>	<b>1163</b>
<b>V_ TR48X</b>	48" X 29"	Cubic Ft: 16.0	Ship Weight: 112	<b>1314</b>	<b>1334</b>	<b>1353</b>

### Transitional Rectangular with Straight Legs

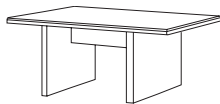

- Vitality design
- High-gloss, HPL top
- Solid hardwood edge
- Straight leg base
- Ships in two cartons

<b>V_ T72</b>	72" X 36" X 29"	Cubic Ft: 13.8	Ship Weight: 163	<b>1478</b>	<b>1500</b>	<b>1522</b>
<b>V_ T96</b>	96" X 42" X 29"	Cubic Ft: 17.4	Ship Weight: 228	<b>2020</b>	<b>2050</b>	<b>2081</b>

### Transitional Rectangular with Straight Legs



- Vitality design
- High-gloss, HPL top
- Two-piece top, wood grain pattern will not match
- Solid hardwood edge
- Straight leg base
- Ships in two cartons

<b>V_ T120</b>	120" X 42" X 29"	Cubic Ft: 27	Ship Weight: 307	<b>2569</b>	<b>2608</b>	<b>2646</b>
<b>V_ T144</b>	144" X 42" X 29"	Cubic Ft: 32	Ship Weight: 351	<b>2798</b>	<b>2840</b>	<b>2882</b>

MEETING & BREAKROOM

**Transitional Rectangular with Cylinder Base**

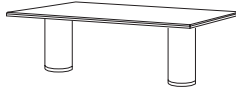

- Vitality design
- High-gloss, HPL top
- Solid hardwood edge
- Cylinder base
- Ships in three cartons (2 pedestal)
- Assembly required

			Zone Pricing	1	2	3
<b>V_ T72CYL</b>	72" X 36" X 29"	Cubic Ft: 31.7	Ship Weight: 310	<b>3323</b>	<b>3373</b>	<b>3423</b>
<b>V_ T96CYL</b>	96" X 42" X 29"	Cubic Ft: 35.3	Ship Weight: 357	<b>3603</b>	<b>3657</b>	<b>3711</b>

**Transitional Rectangular with Cylinder Base**

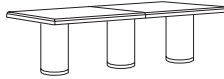

- Vitality design
- High-gloss, HPL top
- Two-piece top, wood grain pattern will not match
- Solid hardwood edge
- Cylinder base
- Ships in four cartons (3 pedestal)
- Assembly required

<b>V_ T120CYL</b>	120" X 42" X 29"	Cubic Ft: 52.4	Ship Weight: 492	<b>4836</b>	<b>4909</b>	<b>4981</b>
<b>V_ T144CYL</b>	144" X 42" X 29"	Cubic Ft: 56.5	Ship Weight: 536	<b>5413</b>	<b>5494</b>	<b>5575</b>

**Transitional Rectangular with Curved Legs**



- Vitality design
- High-gloss, HPL top
- Solid hardwood edge
- Cylinder base
- Ships in two cartons
- Assembly required

<b>V_ T72C</b>	72" X 36" X 29"	Cubic Ft: 17.2	Ship Weight: 159	<b>2174</b>	<b>2207</b>	<b>2239</b>
<b>V_ T96C</b>	96" X 42" X 29"	Cubic Ft: 20.8	Ship Weight: 224	<b>2683</b>	<b>2723</b>	<b>2763</b>

**Transitional Rectangular with Curved Legs**

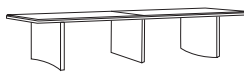

- Vitality design
- High-gloss, HPL top
- Two-piece top, wood grain pattern will not match
- Solid hardwood edge
- Curved leg base
- Ships in two cartons
- Assembly required

<b>V_ T120C</b>	120" X 42" X 29"	Cubic Ft: 32.4	Ship Weight: 300	<b>3593</b>	<b>3647</b>	<b>3701</b>
<b>V_ T144C</b>	144" X 42" X 29"	Cubic Ft: 36.5	Ship Weight: 344	<b>3945</b>	<b>4004</b>	<b>4063</b>

# BEDFORD TABLES SIN 711-9

FINISH SELECTION  
MOHOGANY M | WINDSOR CHERRY WC

## ASSEMBLY

Tables ship with top and base in separate cartons. Assembly is quick and easy by attaching bases to tops with bolts provided.

## OPTION

Pre-installed Plug-N-Play power/data/phone outlet available. See Conference Accessories for details and pricing.

**Quick Ship is not available on any items ordered with option.**

## PACKING

All units are properly packed in heavy duty cartons with heavy duty corner pads. All packaging conforms to or exceeds specifications as outlined in the Uniform Freight Classification.

## PALLETIZATION

See Page 3.

**Specifications subject to change without notice.**

## TRANSITIONAL LAMINATE

- Transitional Design
- 1<sup>3</sup>/<sub>16</sub>" thick tops with Solid Hardwood Edge
- High-Gloss, High Pressure Laminate surface
- Work surface deminsions will vary due to edge profile treatment.

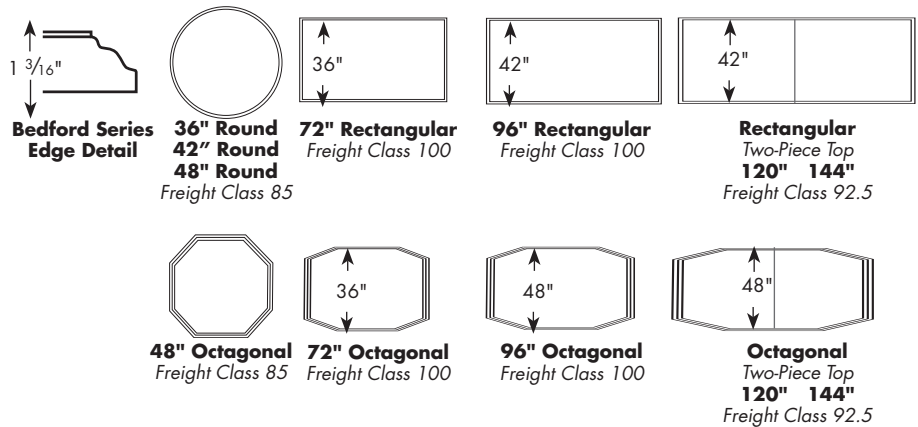

## CONFERENCE TABLE BASES

### Laminate Bases

Straight Leg, Square and X Bases are 1" thick thermally fused laminate; traditional design features hardwood base molding. Square Base includes picture frame molding. Freight Class is the same for 2 or 3 piece bases.

### Wood Bases

Queen Anne Style Bases are carved wood four fluted feet with brass foot caps.



## Traditional Laminate

### Traditional Round with 4-Footed Pedestal



- Bedford design with high-gloss, HPL top
- Shaped hardwood edge
- Queen Anne style carved pedestal fluted legs with brass caps and leg levelers
- Ships in two cartons
- Assembly required

				Zone Pricing		
				1	2	3
<b>TR_TR36</b>		36" X 30"	Cubic Ft: 18.6 Ship Weight: 73	<b>1205</b>	<b>1223</b>	<b>1241</b>
<b>TR_TR42</b>	<b>QS</b>	42" X 30"	Cubic Ft: 18.8 Ship Weight: 97	<b>1486</b>	<b>1508</b>	<b>1531</b>
<b>TR_TR48</b>	<b>QS</b>	48" X 30"	Cubic Ft: 20 Ship Weight: 116	<b>1663</b>	<b>1688</b>	<b>1713</b>

**QS FINISHES**  **M**

### Traditional Octagonal with Square Base

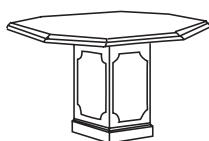

- Bedford design with high-gloss, HPL top
- Shaped hardwood edge
- Square base with traditional base and picture-frame molding
- Ships in two cartons
- Assembly required

<b>TR_TOCT48</b>	<b>QS</b>	48" X 29"	Cubic Ft: 12.8 Ship Weight: 143	<b>1519</b>	<b>1542</b>	<b>1565</b>
------------------	-----------	-----------	---------------------------------	-------------	-------------	-------------

**QS FINISHES**  **M**

MEETING & BREAKROOM



Zone Pricing	1	2	3
--------------	---	---	---

**Traditional Octagonal with 4-Footed Pedestal**

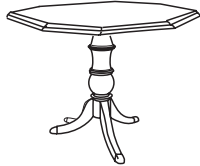

- Bedford design with high-gloss, HPL top
- Shaped hardwood edge
- Queen Anne style carved pedestal fluted legs with brass caps and leg levelers
- Ships in two cartons
- Assembly required

<b>TR_TOCT48P4</b>	48" X 30"	Cubic Ft: 20.4	Ship Weight: 135	<b>2100</b>	<b>2132</b>	<b>2163</b>
--------------------	-----------	----------------	------------------	-------------	-------------	-------------

**Rectangular with 4-Footed Pedestal**



- Bedford design with high-gloss, HPL top
- Shaped hardwood edge
- Queen Anne style carved pedestal fluted legs with brass caps and leg levelers
- Ships in three cartons (2 pedestal)
- Assembly required

<b>TR_T72P4</b>	72" X 36" X 30"	Cubic Ft: 52.6	Ship Weight: 182	<b>2947</b>	<b>2991</b>	<b>3035</b>
-----------------	-----------------	----------------	------------------	-------------	-------------	-------------

<b>TR_T96P4</b>	96" X 42" X 30"	Cubic Ft: 56.1	Ship Weight: 247	<b>3430</b>	<b>3481</b>	<b>3533</b>
-----------------	-----------------	----------------	------------------	-------------	-------------	-------------

**Rectangular with 4-Footed Pedestal**



- Same features as above except:
- Two-piece top, wood grain patterns will not match
- Ships in four cartons (3 pedestal)
- Assembly required

<b>TR_T120P4</b>	120" X 42" X 30"	Cubic Ft: 83.6	Ship Weight: 327	<b>5821</b>	<b>5908</b>	<b>5996</b>
------------------	------------------	----------------	------------------	-------------	-------------	-------------

<b>TR_T144P4</b>	144" X 42" X 30"	Cubic Ft: 87.7	Ship Weight: 371	<b>6332</b>	<b>6427</b>	<b>6522</b>
------------------	------------------	----------------	------------------	-------------	-------------	-------------

**Rectangular with Square Base**

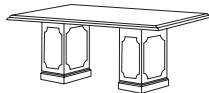

- Bedford design with high-gloss, HPL top
- Shaped hardwood edge
- Square base with traditional base and picture-frame molding
- Ships in three cartons (2 pedestal)
- Assembly required

<b>TR_T72SQ</b>	72" X 36" X 29"	Cubic Ft: 31.8	Ship Weight: 230	<b>2040</b>	<b>2071</b>	<b>2101</b>
-----------------	-----------------	----------------	------------------	-------------	-------------	-------------

<b>TR_T96SQ</b>	96" X 42" X 29"	Cubic Ft: 34.6	Ship Weight: 295	<b>2496</b>	<b>2533</b>	<b>2571</b>
-----------------	-----------------	----------------	------------------	-------------	-------------	-------------

**Rectangular with Square Base**

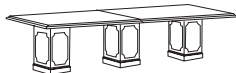

- Same features as above except:
- Two-piece top, wood grain patterns will not match
- Ships in four cartons (3 pedestal)
- Assembly required

<b>TR_T120SQ</b>	120" X 42" X 29"	Cubic Ft: 50.6	Ship Weight: 402	<b>4443</b>	<b>4510</b>	<b>4576</b>
------------------	------------------	----------------	------------------	-------------	-------------	-------------

<b>TR_T144SQ</b>	144" X 42" X 29"	Cubic Ft: 54.7	Ship Weight: 446	<b>5008</b>	<b>5083</b>	<b>5158</b>
------------------	------------------	----------------	------------------	-------------	-------------	-------------

**Rectangular with Straight Legs**



- Bedford design with high-gloss, HPL top
- Shaped hardwood edge
- Base molding
- Ships in two cartons
- Assembly required

<b>TR_T72</b>	<b>QS</b>	72" X 36" X 29"	Cubic Ft: 15.3	Ship Weight: 181	<b>1574</b>	<b>1598</b>	<b>1621</b>
---------------	-----------	-----------------	----------------	------------------	-------------	-------------	-------------

<b>TR_T96</b>	<b>QS</b>	96" X 42" X 29"	Cubic Ft: 18.9	Ship Weight: 235	<b>2121</b>	<b>2153</b>	<b>2185</b>
---------------	-----------	-----------------	----------------	------------------	-------------	-------------	-------------

<b>QS FINISHES</b>	<b>M</b>
--------------------	----------

**Rectangular with Straight Legs**



- Same features as above except:
- Two-piece top, wood grain patterns will not match
- Ships in two cartons
- Assembly required

<b>TR_T120</b>	120" X 42" X 29"	Cubic Ft: 27.3	Ship Weight: 322	<b>3580</b>	<b>3634</b>	<b>3687</b>
----------------	------------------	----------------	------------------	-------------	-------------	-------------

<b>TR_T144</b>	144" X 42" X 29"	Cubic Ft: 31.6	Ship Weight: 366	<b>3967</b>	<b>4027</b>	<b>4086</b>
----------------	------------------	----------------	------------------	-------------	-------------	-------------

# BEDFORD TABLES SIN 711-9

FINISH SELECTION  
MOHOGANY **M** | WINDSOR CHERRY **WC**

Zone  
Pricing

1

2

3

## Octagonal with 4-Footed Pedestal

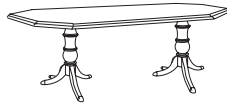

- Bedford design with high-gloss, HPL top
- Shaped hardwood edge
- Queen Anne style carved pedestal with fluted legs with brass caps and leg levelers
- Ships in three cartons (2 pedestal)
- Assembly required

<b>TR_TOCT72P4</b>	72" X 36" X 30"	Cubic Ft: 52.6	Ship Weight: 176	<b>3014</b>	<b>3059</b>	<b>3104</b>
<b>TR_TOCT96P4</b>	96" X 48" X 30"	Cubic Ft: 55.3	Ship Weight: 245	<b>3466</b>	<b>3518</b>	<b>3570</b>

## Octagonal with 4-Footed Pedestal



- Same features as above except:
- Two-piece top, wood grain patterns will not match
- Ships in four cartons (3 pedestal)
- Assembly required

<b>TR_TOCT120P4</b>	120" X 48" X 30"	Cubic Ft: 80.8	Ship Weight: 340	<b>5782</b>	<b>5869</b>	<b>5955</b>
<b>TR_TOCT144P4</b>	144" X 48" X 29"	Cubic Ft: 84.4	Ship Weight: 416	<b>6307</b>	<b>6402</b>	<b>6496</b>

## Octagonal with Straight Legs

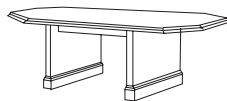

- Bedford design with high-gloss, HPL top
- Shaped hardwood edge
- Base molding
- Ships in two cartons
- Assembly required

<b>TR_TOCT72LG</b>	72" X 36" X 29"	Cubic Ft: 15.3	Ship Weight: 175	<b>1712</b>	<b>1738</b>	<b>1763</b>
<b>TR_TOCT96LG</b>	96" X 48" X 29"	Cubic Ft: 18.1	Ship Weight: 244	<b>2210</b>	<b>2243</b>	<b>2276</b>

## Octagonal with Straight Legs

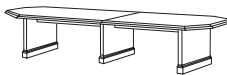

- Same features as above except:
- Two-piece top, wood grain patterns will not match
- Ships in three cartons
- Assembly required

<b>TR_TOCT120LG</b>	120" X 48" X 29"	Cubic Ft: 24.2	Ship Weight: 319	<b>3957</b>	<b>4016</b>	<b>4076</b>
<b>TR_TOCT144LG</b>	144" X 48" X 29"	Cubic Ft: 27.8	Ship Weight: 362	<b>4352</b>	<b>4417</b>	<b>4483</b>

## Octagonal with Square Base

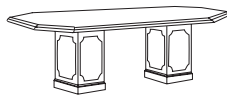

- Bedford design with high-gloss, HPL top
- Shaped hardwood edge
- Square base with traditional base and picture-frame molding
- Ships in three cartons (2 pedestal)
- Assembly required

<b>TR_TOCT72</b>	72" X 36" X 29"	Cubic Ft: 31.0	Ship Weight: 224	<b>2093</b>	<b>2124</b>	<b>2156</b>
<b>TR_TOCT96 QS</b>	96" X 48" X 29"	Cubic Ft: 33.9	Ship Weight: 293	<b>2552</b>	<b>2590</b>	<b>2629</b>

**QS FINISHES** **M**

## Octagonal with Square Base

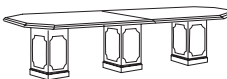

- Same features as above except:
- Two-piece top, wood grain patterns will not match
- Ships in four cartons (3 pedestal)
- Assembly required

<b>TR_TOCT120</b>	120" X 48" X 29"	Cubic Ft: 47.8	Ship Weight: 359	<b>4410</b>	<b>4476</b>	<b>4542</b>
<b>TR_TOCT144</b>	144" X 48" X 29"	Cubic Ft: 51.5	Ship Weight: 442	<b>4976</b>	<b>5051</b>	<b>5125</b>

MEETING & BREAKROOM



### CHARACTERISTICS

#### Top

All tops are 1 1/2" -thick with thermally fused laminate surface, proper backing and full 3 millimeter PVC AdvantEdge banding as required.

#### Base

Base panels are 1" thick core with thermally fused laminate on both sides and full 3 millimeter PVC AdvantEdge banding as required.

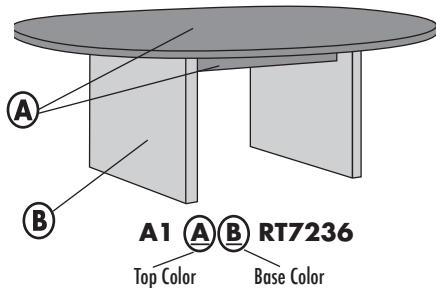

### TABLE FINISH CHART

Code	Finish Name	Tops	Bases
FM	Natural Maple	X	X
WC	Windsor Cherry	X	X
M	Mahogany	X	X
GP	Graphite		X
O	Medium Oak		X
AP	Aspen	X	X
PW	Pearwood		X
E	Black		X
X	Espresso		X
G	Grey		X
CC	Classic Cherry		X

Select a color combination with contrasting top and base, or choose monocolour for same top and base. Monocolour models use a single finish designator.

### ASSEMBLY

Tables ship with top and base in separate cartons. Assembly is quick and easy by attaching bases to tops with bolts or screws provided.

### OPTION

Pre-installed Plug-N-Play power/data/phone outlet available. See Conference Accessories for details and pricing.

**Quick Ship is not available on any items ordered with option.**

### PACKING

All units are properly packed in heavy duty cartons with heavy duty corner pads. All packaging conforms to or exceeds specifications as outlined in the Uniform Freight Classification.

### PALLETIZATION

See Page 3.

**Specifications subject to change without notice.**

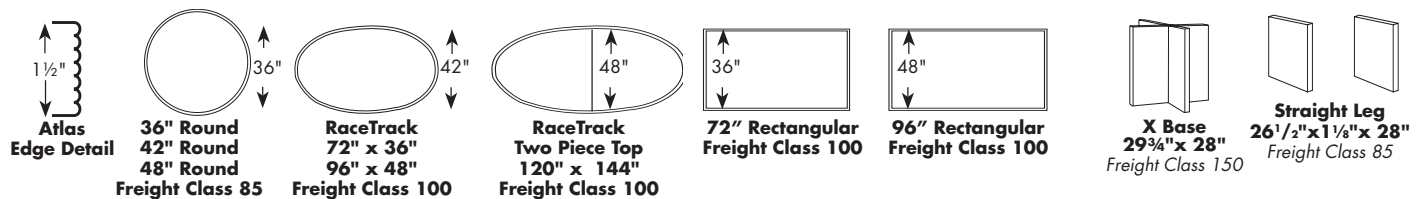

## Contemporary Laminate

Zone Pricing	1	2	3
--------------	---	---	---

### Round Conference Table

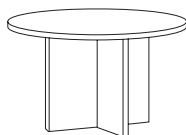

- 1-1/2" thick top
- X base for increased stability
- Ships in two cartons
- Assembly required

Freight Class: 150

A1_TR36	36" X 29.5"	Cubic Ft: 11.1	Ship Weight: 94	833	845	858
A1_TR42	42" X 29.5"	Cubic Ft: 15.3	Ship Weight: 120	1012	1027	1042
A1_TR48	48" X 29.5"	Cubic Ft: 17.8	Ship Weight: 143	1050	1066	1082

### RaceTrack Conference Table

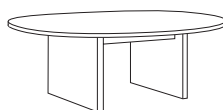

- Contemporary oval shape
- One-piece top, 1-1/2" thick
- Two support legs
- Ships in two cartons
- Assembly required

Freight Class: 92.5

A1_RT7236	72" X 36" X 29.5"	Cubic Ft: 13.8	Ship Weight: 175	1100	1117	1133
-----------	-------------------	----------------	------------------	------	------	------

# ATLAS TABLES

SIN 711-9

Zone  
Pricing

1

2

3

## RaceTrack Conference Table

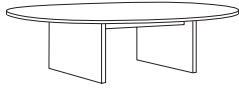

- Contemporary oval shape
- One-piece top, 1-1/2" thick
- Two support legs
- Ships in two cartons
- Assembly required

<b>A1_RT9648</b>	96" X 48" X 29.5"	Cubic Ft: 21.6	Ship Weight: 253	<b>1308</b>	<b>1328</b>	<b>1347</b>
------------------	-------------------	----------------	------------------	-------------	-------------	-------------

Freight Class: 92.5

## RaceTrack Conference Table

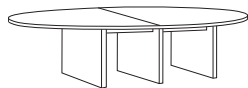

- Contemporary oval shape
- Two-piece top, 1-1/2" thick, wood grain patterns will not match
- Three support legs
- Ships in two cartons
- Assembly required

<b>A1_RT12048</b>	120" X 48" X 29.5"	Cubic Ft: 27	Ship Weight: 358	<b>1687</b>	<b>1712</b>	<b>1738</b>
-------------------	--------------------	--------------	------------------	-------------	-------------	-------------

<b>A1_RT14448</b>	144" X 48" X 29.5"	Cubic Ft: 32	Ship Weight: 380	<b>1826</b>	<b>1853</b>	<b>1881</b>
-------------------	--------------------	--------------	------------------	-------------	-------------	-------------

Freight Class: 92.5

## RaceTrack Conference Table

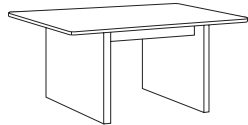

- One-piece top, 1-1/2" thick, wood grain patterns will not match
- Two support legs
- Ships in two cartons
- Assembly required

<b>A1_T7236</b>	72" X 36" X 29.5"	Cubic Ft: 13.8	Ship Weight: 178	<b>1042</b>	<b>1058</b>	<b>1073</b>
-----------------	-------------------	----------------	------------------	-------------	-------------	-------------

<b>A1_T9648</b>	96" X 48" X 29.5"	Cubic Ft: 21.6	Ship Weight: 273	<b>1271</b>	<b>1290</b>	<b>1309</b>
-----------------	-------------------	----------------	------------------	-------------	-------------	-------------

Freight Class: 92.5

MEETING & BREAKROOM



## CHARACTERISTICS

### Tops

All tops are 1" thick with thermally fused laminate surface, proper backing and full 3 millimeter PVC AdvantEdge banding as required. High pressure laminate tops available.

### Base

Base panels are 1" thick core with thermally fused laminate on both sides and full 3 millimeter PVC AdvantEdge banding as required.

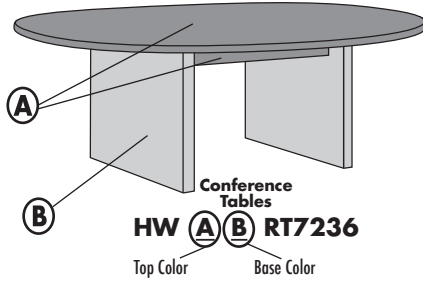

## TABLE FINISH CHART

Code	Finish	Tops	Bases
FM	Natural Maple	X	X
WC	Windsor Cherry*	X	X
M	Mahogany*	X	X
GP	Graphite	X	X
O	Medium Oak	X	X
AP	Aspen	X	X
PW	Pearwood		X
E	Black		X
X	Espresso	X	X
G	Grey*	X	X
CC	Classic Cherry	X	X

Select a color combination with contrasting top and base, or choose monocolour for same top and base. Monocolour models use a single finish designator.

\*High pressure laminate tops are available in Windsor Cherry, Mahogany and Grey.

## ASSEMBLY

Tables ship with top and base in separate cartons. Assembly is quick and easy by attaching bases to tops with bolts or screws provided.

## OPTION

Pre-installed Plug-N-Play power/data/phone outlet available. See Conference Accessories for details and pricing.

**Quick Ship is not available on any items ordered with option.**

## PACKING

All units are properly packed in heavy duty cartons with heavy duty corner pads. All packaging conforms to or exceeds specifications as outlined in the Uniform Freight Classification.

## PALLETIZATION

See Page 3.

**Specifications subject to change without notice.**

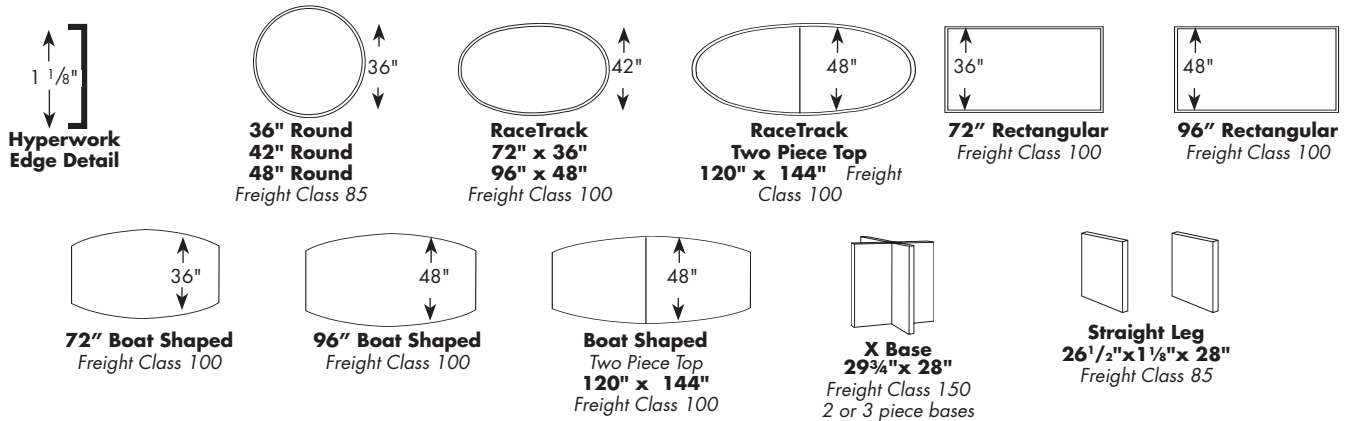

Zone Pricing	1	2	3
--------------	---	---	---

## Contemporary Laminate

### Round Conference Table

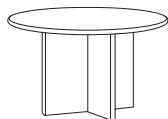

- 1-1/8"-thick top
- X-base for increased stability
- Ships in two cartons
- Assembly required

HW_TR36	36" X 29"	Cubic Ft: 10.7	Ship Weight: 85	683	693	703
HW_TR42	42" X 29"	Cubic Ft: 14.8	Ship Weight: 109	824	836	849
HW_TR48	48" X 29"	Cubic Ft: 17.1	Ship Weight: 120	869	882	895

# HYPERWORK TABLES

SIN 711-9

Edge Profile



How to Order

HW WC RT7236  
Finish

CONTEMPORARY LAMINATE TABLES

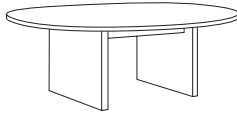
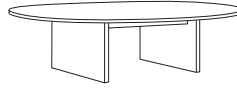
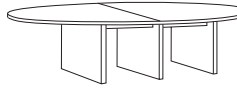
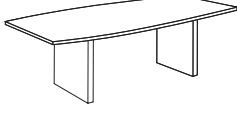
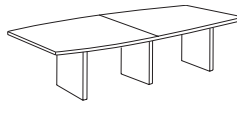
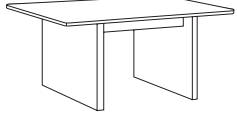



			Zone Pricing	1	2	3
<b>RaceTrack Conference Table</b>  <ul style="list-style-type: none"> <li>• Contemporary oval shape</li> <li>• One-piece top, 1-1/8"-thick</li> <li>• Two support legs</li> <li>• Ships in two cartons</li> <li>• Assembly required</li> </ul>	<b>HW_RT7236</b>	72" X 36" X 29"	Cubic Ft: 13.8 Ship Weight: 144	<b>1050</b>	<b>1066</b>	<b>1082</b>
<b>RaceTrack Conference Table</b>  <ul style="list-style-type: none"> <li>• Contemporary oval shape</li> <li>• One-piece top 1-1/8"-thick</li> <li>• Two support legs</li> <li>• Ships in two cartons</li> <li>• Assembly required</li> </ul>	<b>HW_RT9648</b>	96" X 48" X 29"	Cubic Ft: 21.6 Ship Weight: 225	<b>1237</b>	<b>1256</b>	<b>1274</b>
<b>RaceTrack Conference Table</b>  <ul style="list-style-type: none"> <li>• Contemporary oval shape</li> <li>• Two-piece top 1-1/8"-thick; wood grain patterns will not match</li> <li>• Three support legs</li> <li>• Ships in two cartons</li> <li>• Assembly required</li> </ul>	<b>HW_RT12048</b>	120" X 48" X 29"	Cubic Ft: 27 Ship Weight: 310	<b>1551</b>	<b>1574</b>	<b>1598</b>
	<b>HW_RT14448</b>	144" X 48" X 29"	Cubic Ft: 32 Ship Weight: 356	<b>1661</b>	<b>1686</b>	<b>1711</b>
<b>Boat Shaped Conference Table</b>  <ul style="list-style-type: none"> <li>• Boat shaped top</li> <li>• One piece top</li> <li>• Straight legs</li> <li>• Ships in two cartons</li> <li>• Assembly required</li> </ul>	<b>HW_BT7236</b>	72" X 36" X 29"	Cubic Ft: 13.8 Ship Weight: 144	<b>1050</b>	<b>1066</b>	<b>1082</b>
	<b>HW_BT9648</b>	96" X 48" X 29"	Cubic Ft: 21.6 Ship Weight: 225	<b>1237</b>	<b>1256</b>	<b>1274</b>
<b>Boat Shaped Conference Table</b>  <ul style="list-style-type: none"> <li>• Boat shaped 1-1/8" thick top</li> <li>• Two piece top; wood grain patterns will not match</li> <li>• Straight legs</li> <li>• Ships in two cartons</li> <li>• Assembly required</li> </ul>	<b>HW_BT12048</b>	120" X 48" X 29"	Cubic Ft: 27 Ship Weight: 310	<b>1551</b>	<b>1574</b>	<b>1598</b>
	<b>HW_BT14448</b>	144" X 48" X 29"	Cubic Ft: 32 Ship Weight: 356	<b>1661</b>	<b>1686</b>	<b>1711</b>
<b>Rectangular Conference Table</b>  <ul style="list-style-type: none"> <li>• One-piece top 1-1/8"-thick</li> <li>• Two support legs</li> <li>• Ships in two cartons</li> <li>• Assembly required</li> </ul>	<b>HW_T7236</b>	72" X 36" X 29"	Cubic Ft: 13.8 Ship Weight: 159	<b>858</b>	<b>871</b>	<b>884</b>
	<b>HW_T9648</b>	96" X 48" X 29"	Cubic Ft: 21.6 Ship Weight: 245	<b>1100</b>	<b>1117</b>	<b>1133</b>

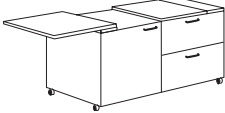
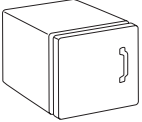

## FINISH SELECTION

NATURAL MAPLE **FM** | WINDSOR CHERRY **WC** | MAHOGANY **M** |  
 GRAPHITE **GP** | MEDIUM OAK **O** | ASPEN **AP** | PEARWOOD **PW** |  
 BLACK **E** | ESPRESSO **X** | GREY **G** | CLASSIC CHERRY **CC** | SIN 711-2

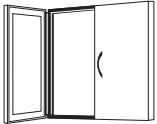
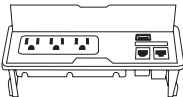
# CONFERENCE ACCESSORIES

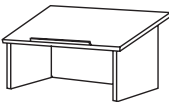
		Zone Pricing		1	2	3
 <p><b>Mobile Server Credenza</b></p> <ul style="list-style-type: none"> <li>• Flip-open top with concealed hinges extend surface to 72" wide</li> <li>• Inside Drawer Dimensions: 20" x 18" x 13" top right (stores 2 liter bottles upright)</li> <li>• 20" x 18" x 8" bottom right</li> <li>• Inside compartment dimensions: 22" x 21" x 24" left side</li> <li>• Door compartment includes nine holes for ventilation of small refrigerator</li> <li>• Casters for mobility</li> </ul> <p>Freight Class: 125</p>	<b>H_2248</b>	48" X 30" X 29"	Cubic Ft: 25.3 Ship Weight: 228	<b>1498</b>	<b>1520</b>	<b>1543</b>
	<b>Pulls:</b>	BRUSHED CHROME <b>HW</b>	EBONY <b>HE</b>	BRIGHT BRASS <b>HB</b>	OVAL NICKEL <b>HD</b>	
 <p><b>Compact Refrigerator</b></p> <ul style="list-style-type: none"> <li>• Small ice tray compartment</li> <li>• 2 removeable shelves</li> <li>• Requires 120 volt grounded electrical outlet</li> <li>• Do not use extension cord</li> </ul> <p>Freight Class: 92.5</p>	<b>SERVERFRIDGE</b>	19" X 20.5" X 16"	Cubic Ft: 4.2 Ship Weight: 46	<b>744</b>	<b>755</b>	<b>766</b>
 <p><b>Mobile Server Cart</b></p> <ul style="list-style-type: none"> <li>• Flip-open top</li> <li>• Top drawer 20" x 18" x 13"H stores 2-liter soda bottles upright</li> <li>• Bottom drawer 20" x 18" x 8"H</li> <li>• Casters for mobility</li> <li>• 3/8" thick drawer bottoms</li> </ul> <p>Freight Class: 100</p>	<b>H_2224</b>	24.25" X 24.5" X 29"	Cubic Ft: 16.7 Ship Weight: 150	<b>1321</b>	<b>1341</b>	<b>1361</b>
	<b>Pulls:</b>	BRUSHED CHROME <b>HW</b>	EBONY <b>HE</b>	BRIGHT BRASS <b>HB</b>	OVAL NICKEL <b>HD</b>	
 <p><b>Marker Board</b></p> <ul style="list-style-type: none"> <li>• Marker board 45" x 42" inside</li> <li>• Eraser and marker kit included</li> <li>• Reverse-side of doors feature grey fabric-covered tackable surface</li> <li>• Magnetic door catches</li> <li>• Optional pre-installed Projection Screen available; add "P" to model number</li> </ul> <p>Freight Class: 100</p>	<b>H_MB</b>	48" X 4.5" X 48"	Cubic Ft: 12.2 Ship Weight: 141	<b>1124</b>	<b>1141</b>	<b>1158</b>
	<b>Pulls:</b>	BRUSHED CHROME <b>HW</b>	EBONY <b>HE</b>	BRIGHT BRASS <b>HB</b>	OVAL NICKEL <b>HD</b>	
<p><b>Projection Screen</b></p> <ul style="list-style-type: none"> <li>• Roll down projector screen fits inside Marker Board</li> <li>• Requires removal of fascia board for installation</li> </ul> <p>Freight Class: 125</p>	<b>PROJECTSCREEN</b>	40" X 48"	Cubic Ft: 1.2 Ship Weight: 5	<b>137</b>	<b>139</b>	<b>141</b>
 <p><b>Plug-n-Play</b></p> <ul style="list-style-type: none"> <li>• Conference tables application</li> <li>• Installed, specify location on table for installation</li> <li>• Three power outlets</li> <li>• One data (RJ45) hookup</li> <li>• One phone (RJ11) hookup</li> <li>• Flip-open cover</li> <li>• USB port</li> </ul> <p>Freight Class: 75</p>	<b>PNP QS</b>	7.75" X 2.75" X 1.75"	Cubic Ft: 0 Ship Weight: 2	<b>171</b>	<b>174</b>	<b>176</b>
 <p><b>Standing Lectern</b></p> <ul style="list-style-type: none"> <li>• Pencil/document catch on angled surface</li> <li>• 2 storage shelves for presentation materials</li> <li>• 4 casters included for field installation, 2 locking</li> </ul> <p>Freight Class: 125</p>	<b>HW_LS46C</b>	24" X 15" X 46"	Cubic Ft: 13.8 Ship Weight: 83	<b>700</b>	<b>711</b>	<b>721</b>
 <p><b>Table Top Lectern</b></p> <ul style="list-style-type: none"> <li>• Fits on any table top</li> <li>• Hardwood pencil/document ledge</li> <li>• Mar-resistant laminate finish</li> <li>• Non-skid gasket on bottom edges</li> </ul> <p>Freight Class: 125</p>	<b>HW_LS18</b>	24" X 14" X 18"	Cubic Ft: 5 Ship Weight: 20	<b>368</b>	<b>374</b>	<b>379</b>

# HEALTHCARE



**FINISH SELECTION**

ASPEN AP | BLACK BLK | NATURAL FM | HONEY CHERRY HCY | ROUGE MAHOGANY RM | MAHOGANY MAH | MOAB MOB | PEARWOOD PW | WALNUT WAL | WINDSOR CHERRY WC | CLASSIC CHERRY CCY | ESPRESSO ESP |

SIN VARIOUS **RECLINERS HANNAH**

**HEALTHCARE**

**Comfort, Form and Function**

Comfort, form and function are the essential building blocks for any HPFI® product. Nowhere is this more critical than in a healthcare setting where patient comfort is essential to maximize relaxation and recovery while providing caregivers with equipment that looks great and performs flawlessly.

**Design Details**

- **Hannah 830** - Lay-flat mechanism allows for administering a wide variety of treatments without use of a bed or gurney. Trendelenburg feature offers a negative 3 degree pitch from the full flatbed position is operated by hands free foot pedal. Rated to 500 lbs.
- **Haley 845** - Comfort is provided through a body activated recliner mechanism housed in a streamlined frame. Full length footrest supports entire leg. Rated to 350 lbs.

**Options Available**

- Small tablet arm with double articulating mechanism
- Large tablet arm on brushed aluminum single pivot
- Folding side table
- Black polyurethane or wood arm caps
- IV pole and holder
- Black or aluminum push bar for Hannah chairs

**Shipping Information**

- All recliners ship with back detached
- Simple assembly required.

**Warranty Information**

- Limited lifetime on seating components.
- Three years warranty on recliner mechanism



Hannah 830 in upright and extended position



Hannah 834



Haley 843

**Hannah**

**830 Hannah Patient Recliner**

33" W X 39" D X 44" H

St. Yardage: 6.5

SIN #71-316



FREIGHT CLASS: 150  
CUBIC FT: 39  
SHIP WEIGHT: 221

Grade	1	2	3	4	5	6	7	8	9	10	L	LL
Zone 1	3093	3187	3277	3382	3474	3595	3717	3839	3961	4113	4341	5088
Zone 2	3139	3235	3326	3433	3526	3649	3773	3897	4020	4175	4406	5164
Zone 3	3186	3283	3375	3483	3578	3703	3829	3954	4080	4236	4471	5241

- 73" Depth when reclined flat
- Lay flat mechanism includes Trendelenburg tilt which allows a 3° negative pitch from flatbed
- Pull-out foot tray
- Four 3" twin wheel non-marking swivel casters, rear locking
- Pneumatically controlled back release located outside right arm facing offers infinite adjustments
- Back release can be located inside or outside of either arm
- Footrest operated by black lever on left arm facing
- Rated to 500 lbs
- See series overview
- Seat: 23.5"W x 20"D x 20"H

OPTION	PRICE	CODE
Softer Seat Foam-Chair	16.00	SF
Aluminum Push Bar	296.00	PB
Black Push Bar	159.00	BB
Dbi Pivot Tablet	626.00	DPS
Pivoting Tablet	467.00	LPT
Folding Tablet	285.00	FT
IV Pole /Holder	340.00	PL
Moisture Barrier	69.00	MB
Wood Arm Cap	225.00	WA
Black Arm Cap	172.00	PA
Aluminum Lever	216.00	RA
Heat & Massage	1,367.00	HM
Oxygen Tank Holder	186.00	OX
Foley/Accessory Hook	100.00	FH

**QS**

ALL FOAM & FABRICS USED ARE CAL 117 APPROVED

**QS** indicates a Quickship item if ordered in Quickship upholstery. Quick Ship is not available on any item ordered with options.

# HANNAH SIN VARIOUS

## FINISH SELECTION

ASPEN **AP** | BLACK **BLK** | NATURAL **FM** | HONEY CHERRY **HCY** | ROUGE  
 MAHOGANY **RM** | MAHOGANY **MAH** | MOAB **MOB** | PEARWOOD **PW** | WALNUT  
 WAL | WINDSOR CHERRY **WC** | CLASSIC CHERRY **CCY** | ESPRESSO **ESP** |

HEALTHCARE

### 831 Hannah Patient Recliner (Non Trendelenburg)

33" W X 39" D X 44" H

St. Yardage: 6.5

SIN #71-316



Grade	1	2	3	4	5	6	7	8	9	10	L	LL
Zone 1	2611	2703	2793	2900	2992	3113	3235	3357	3479	3631	3859	4606
Zone 2	2650	2744	2835	2944	3037	3160	3284	3407	3531	3685	3917	4675
Zone 3	2689	2784	2877	2987	3082	3206	3332	3458	3583	3740	3975	4744

- Same features as 830 except:
- Excludes Trendelenburg feature and pull-out foot tray
- Includes two fixed and two swivel casters

OPTION	PRICE	CODE
Softer Seat Foam-Chair	16.00	SF
Aluminum Push Bar	296.00	PB
Black Push Bar	159.00	BB
Dbi Pivot Tablet	626.00	DPS
Pivoting Tablet	467.00	LPT
Folding Tablet	285.00	FT
IV Pole /Holder	340.00	PL
Moisture Barrier	69.00	MB
Wood Arm Cap	225.00	WA
Black Arm Cap	172.00	PA
Aluminum Lever	216.00	RA
Heat & Massage	1,367.00	HM
Oxygen Tank Holder	186.00	OX
Foley/Accessory Hook	100.00	FH

FREIGHT CLASS: 150  
 CUBIC FT: 39  
 SHIP WEIGHT: 186

**QS**

### 832 Hannah Bariatric Patient Recliner

37" W X 39" D X 46" H

St. Yardage: 7.5

SIN #71-316

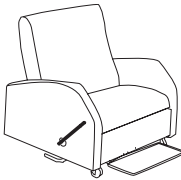

Grade	1	2	3	4	5	6	7	8	9	10	L	LL
Zone 1	3713	3817	3939	4047	4152	4293	4433	4574	4714	4890	5228	6015
Zone 2	3769	3874	3998	4108	4214	4357	4499	4643	4785	4963	5306	6105
Zone 3	3824	3932	4057	4168	4277	4422	4566	4711	4855	5037	5385	6195

- 73" Depth when reclined flat
- Lay flat mechanism includes Trendelenburg tilt which allows a 3° negative pitch from flatbed
- Pull-out foot tray
- 28.15" wide seat
- Four 3" twi wheel non-marking swivel casters, rear locking
- Pneumatically controlled back release located outside right arm facing offers infinite adjustments
- Back release can be located inside or outside of either arm
- Footrest operated by black lever on lewft arm facing
- Rated to 750 lbs
- Seat: 28.5"W x 20"D x 20"H

OPTION	PRICE	CODE
Softer Seat Foam-Chair	16.00	SF
Aluminum Push Bar	296.00	PB
Black Push Bar	159.00	BB
Dbi Pivot Tablet	626.00	DPS
Pivoting Tablet	467.00	LPT
Folding Tablet	285.00	FT
IV Pole /Holder	340.00	PL
Moisture Barrier	69.00	MB
Wood Arm Cap	225.00	WA
Black Arm Cap	172.00	PA
Aluminum Lever	216.00	RA
Heat and Massage	1367.00	HM
Oxygen Tank Holder	186.00	OX
Foley/Accessory Hook	100.00	FH

FREIGHT CLASS: 150  
 CUBIC FT: 45  
 SHIP WEIGHT: 238

**QS**

### 833 Hannah Bariatric Recliner (Non Trendelenburg)

37" W X 39" D X 46" H

St. Yardage: 7.5

SIN #71-316

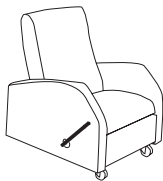

Grade	1	2	3	4	5	6	7	8	9	10	L	LL
Zone 1	3129	3237	3363	3481	3592	3740	3889	4037	4185	4370	4689	5556
Zone 2	3176	3286	3413	3533	3646	3796	3947	4098	4248	4436	4759	5639
Zone 3	3223	3334	3464	3585	3700	3852	4006	4158	4311	4501	4830	5723

- Same features as 832 except:
- Excludes Trendelenburg feature and pull-out foot tray
- Includes two fixed and two swivel casters

OPTION	PRICE	CODE
Softer Seat Foam-Chair	16.00	SF
Aluminum Push Bar	296.00	PB
Black Push Bar	159.00	BB
Dbi Pivot Tablet	626.00	DPS
Pivoting Tablet	467.00	LPT
Folding Tablet	285.00	FT
IV Pole /Holder	340.00	PL
Moisture Barrier	69.00	MB
Wood Arm Cap	225.00	WA
Black Arm Cap	172.00	PA
Aluminum Lever	216.00	RA
Heat & Massage	1,367.00	HM
Oxygen Tank Holder	186.00	OX
Foley/Accessory Hook	100.00	FH

FREIGHT CLASS: 150  
 CUBIC FT: 45  
 SHIP WEIGHT: 203

**QS**

**FINISH SELECTION**

ASPEN **AP** | BLACK **BLK** | NATURAL **FM** | HONEY CHERRY **HCY** | ROUGE  
 MAHOGANY **RM** | MAHOGANY **MAH** | MOAB **MOB** | PEARWOOD **PW** | WALNUT  
 WAL | WINDSOR CHERRY **WC** | CLASSIC CHERRY **CCY** | ESPRESSO **ESP** |

SIN VARIOUS **HANNAH**

**HEALTHCARE**

**834 Hannah Patient Recliner, Pillow Back**

33" W X 39" D X 46" H

St. Yardage: 8.25

SIN #71-316

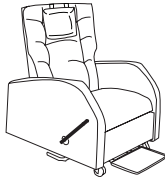

FREIGHT CLASS: 150  
 CUBIC FT: 39  
 SHIP WEIGHT: 206

Grade	1	2	3	4	5	6	7	8	9	10	L	LL
<b>Zone 1</b>	3219	3309	3414	3531	3629	3760	3891	4023	4154	4318	4532	5367
<b>Zone 2</b>	3267	3359	3465	3584	3683	3816	3949	4083	4216	4383	4600	5448
<b>Zone 3</b>	3316	3408	3516	3637	3738	3873	4008	4144	4279	4448	4668	5528

- 73" Depth when reclined flat
- Pillow back with extra repositionable pillow
- Lay flat mechanism includes Trendelenburg tilt which allows a 3° negative pitch from flatbed
- Pull-out foot tray
- Four 3" twin wheel non-marking swivel casters, rear locking
- Pneumatically controlled back release located outside right arm facing offers infinite adjustments
- Footrest operated by black lever on left arm facing
- Rated to 500 lbs
- See series overview
- Seat: 23.5"W x 20"D x 20"H

OPTION	PRICE	CODE
Softer Seat Foam-Chair	16.00	SF
Aluminum Push Bar	296.00	PB
Black Push Bar	159.00	BB
Dbl Pivot Tablet	626.00	DPS
Pivoting Tablet	467.00	LPT
Folding Tablet	285.00	FT
IV Pole /Holder	340.00	PL
Moisture Barrier	69.00	MB
Wood Arm Cap	225.00	WA
Black Arm Cap	172.00	PA
Aluminum Lever	216.00	RA
Oxygen Tank Holder	186.00	OX
Foley/Accessory Hook	100.00	FH

**QS**

**835 Hannah Patient Recliner, Pillow Back (Non Trendelenburg)**

33" W X 39" D X 46" H

St. Yardage: 8.25

SIN #71-316



FREIGHT CLASS: 150  
 CUBIC FT: 39  
 SHIP WEIGHT: 165

Grade	1	2	3	4	5	6	7	8	9	10	L	LL
<b>Zone 1</b>	2750	2840	2946	3062	3160	3291	3422	3554	3685	3849	4063	4898
<b>Zone 2</b>	2791	2883	2990	3108	3207	3340	3473	3607	3740	3907	4124	4971
<b>Zone 3</b>	2833	2925	3034	3154	3255	3390	3525	3661	3796	3964	4185	5045

- Same features as 834 except:
- Excludes Trendelenburg feature and pull-out foot tray
- Includes two fixed and two swivel casters

OPTION	PRICE	CODE
Softer Seat Foam-Chair	16.00	SF
Aluminum Push Bar	296.00	PB
Black Push Bar	159.00	BB
Dbl Pivot Tablet	626.00	DPS
Pivoting Tablet	467.00	LPT
Folding Tablet	285.00	FT
IV Pole /Holder	340.00	PL
Moisture Barrier	69.00	MB
Wood Arm Cap	225.00	WA
Black Arm Cap	172.00	PA
Aluminum Lever	216.00	RA
Oxygen Tank Holder	186.00	OX
Foley/Accessory Hook	100.00	FH

**QS**

**836 Hannah Bariatric Pillow Back Patient Recliner**

37" W X 39" D X 46" H

St. Yardage: 9.5

SIN #71-316



FREIGHT CLASS: 150  
 CUBIC FT: 45  
 SHIP WEIGHT: 221

Grade	1	2	3	4	5	6	7	8	9	10	L	LL
<b>Zone 1</b>	3434	3538	3660	3790	3903	4052	4202	4352	4502	4690	4949	5889
<b>Zone 2</b>	3486	3591	3715	3847	3962	4113	4265	4417	4570	4760	5023	5977
<b>Zone 3</b>	3537	3644	3770	3904	4020	4174	4328	4483	4637	4831	5097	6066

- Same features as 834 Patient's chair except:
- 28.5" wide seat
- Rated at 750 lbs
- Seat: 28.5"W x 20"D x 20"H

OPTION	PRICE	CODE
Softer Seat Foam-Chair	16.00	SF
Aluminum Push Bar	296.00	PB
Black Push Bar	159.00	BB
Dbl Pivot Tablet	626.00	DPS
Pivoting Tablet	467.00	LPT
Folding Tablet	285.00	FT
IV Pole /Holder	340.00	PL
Moisture Barrier	69.00	MB
Wood Arm Cap	225.00	WA
Black Arm Cap	172.00	PA
Aluminum Lever	216.00	RA
Oxygen Tank Holder	186.00	OX
Foley/Accessory Hook	100.00	FH

**QS**

**ALL FOAM & FABRICS USED ARE CAL 117 APPROVED**

**QS** indicates a Quickship item if ordered in Quickship upholstery. Quick Ship is not available on any item ordered with options.

### 837 Hannah Bariatric Recliner, Pillow Back (Non Trendelenburg)

37" W X 39" D X 46" H

St. Yardage: 9.5

SIN #71-316

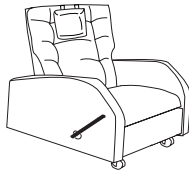

FREIGHT CLASS: 150  
 CUBIC FT: 45  
 SHIP WEIGHT: 186

Grade	1	2	3	4	5	6	7	8	9	10	L	LL
Zone 1	2965	3070	3192	3321	3434	3583	3733	3883	4033	4221	4577	5420
Zone 2	3009	3116	3240	3371	3485	3637	3789	3942	4094	4284	4645	5501
Zone 3	3054	3162	3288	3421	3537	3691	3845	4000	4154	4347	4714	5583

- Same features as 834 Patient's chair except:
- 28.5" wide seat
- Excludes Trendelenburg feature and pullout foot tray
- Includes two fixed and two swivel casters
- Rated at 750 lbs
- Seat: 28.5"W x 20"D x 20"H

OPTION	PRICE	CODE
Softer Seat Foam-Chair	16.00	SF
Aluminum Push Bar	296.00	PB
Black Push Bar	159.00	BB
DbI Pivot Tablet	626.00	DPS
Pivoting Tablet	467.00	LPT
Folding Tablet	285.00	FT
IV Pole /Holder	340.00	PL
Moisture Barrier	69.00	MB
Wood Arm Cap	225.00	WA
Black Arm Cap	172.00	PA
Aluminum Lever	216.00	RA
Oxygen Tank Holder	186.00	OX
Foley/Accessory Hook	100.00	FH

QS

## HALEY

### 810 Haley Recliner, Central Braking Casters

29.75" W X 37.5" D X 46.75" H

St. Yardage: 6.75

SIN #711-16

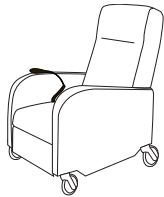

(Line art shows remote control for optional motor assist)

FREIGHT CLASS: 150  
 CUBIC FT: 39  
 SHIP WEIGHT: 156

Grade	1	2	3	4	5	6	7	8	9	10	L	LL
Zone 1	2752	2844	2951	3069	3169	3302	3436	3569	3702	3869	4082	4536
Zone 2	2793	2887	2995	3115	3217	3352	3488	3623	3758	3927	4143	4604
Zone 3	2835	2929	3040	3161	3264	3401	3539	3676	3813	3985	4204	4672

- 70" Depth when reclined
- Central Braking Casters (Green - One rear caster restricted to straight, Neutral - All casters swivel, Red - Locks rear casters)
- 3 Position push arm mechanism standard
- Full length foot
- Seat: 20.75"W x 20"D x 20"H

OPTION	PRICE	CODE
Softer Seat Foam-Chair	16.00	SF
DbI Pivot Tablet	626.00	DPS
Pivoting Tablet	467.00	LPT
Folding Tablet	285.00	FT
IV Pole/Holder	340.00	PL
Moisture Barrier	69.00	MB
Wood Arm Cap	225.00	WA
Black Arm Cap	172.00	PA
AC Motor Assist Mech	400.00	MT
Battery Powered Motor Assi	700.00	MTB
Heat & Massage	1,367.00	HM
Black Push Bar	159.00	BB
Aluminum Push Bar	296.00	PB
Oxygen Tank Holder	186.00	OX

QS

### 815 Haley Recliner, Central Braking Casters Pillow Back

29.25" W X 37.5" D X 46.75" H

St. Yardage: 8.5

SIN #711-16

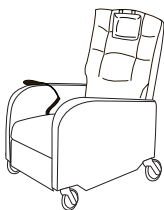

(Line art shows remote control for optional motor assist)

FREIGHT CLASS: 150  
 CUBIC FT: 39  
 SHIP WEIGHT: 156

Grade	1	2	3	4	5	6	7	8	9	10	L	LL
Zone 1	2972	3071	3186	3312	3420	3563	3706	3850	3993	4172	4400	4918
Zone 2	3017	3117	3234	3362	3471	3616	3762	3908	4053	4235	4466	4992
Zone 3	3061	3163	3282	3411	3523	3670	3817	3966	4113	4297	4532	5066

- Same features as above except:
- Pillow back with extra repositionable pillow

OPTION	PRICE	CODE
Softer Seat Foam-Chair	16.00	SF
DbI Pivot Tablet	626.00	DPS
Pivoting Tablet	467.00	LPT
Folding Tablet	285.00	FT
IV Pole/Holder	340.00	PL
Moisture Barrier	69.00	MB
Wood Arm Cap	225.00	WA
Black Arm Cap	172.00	PA
AC Motor Assist Mech	400.00	MT
Battery Powered Motor Assi	700.00	MTB
Black Push Bar	159.00	BB
Aluminum Push Bar	296.00	PB
Oxygen Tank Holder	186.00	OX

QS



FINISH SELECTION

ASPEN AP | BLACK BLK | NATURAL FM | HONEY CHERRY HCY | ROUGE MAHOGANY RM | MAHOGANY MAH | MOAB MOB | PEARWOOD PW | WALNUT WAL | WINDSOR CHERRY WC | CLASSIC CHERRY CCY | ESPRESSO ESP |

SIN VARIOUS **HALEY**

HEALTHCARE

**840 Haley Recliner**

29" W X 37.5" D X 46.75" H

St. Yardage: 6.5

SIN #711-16

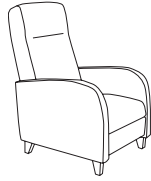

Grade	1	2	3	4	5	6	7	8	9	10	L	LL
Zone 1	1999	2086	2174	2266	2350	2463	2575	2688	2800	2941	3195	3840
Zone 2	2029	2117	2207	2300	2385	2500	2614	2728	2842	2985	3243	3898
Zone 3	2059	2149	2239	2334	2421	2537	2652	2769	2884	3029	3291	3955

- 70" Depth when reclined
- 3 position push arm mechanism
- Full length foot rest supports entire leg
- Push bar option should only be ordered if ordering optional 3" casters
- Rated to 350 lbs
- Seat: 20.75"W x 20"D x 20"H

OPTION	PRICE	CODE
Softer Seat Foam-Chair	16.00	SF
Dbi Pivot Tablet	626.00	DPS
Pivoting Tablet	467.00	LPT
Folding Tablet	285.00	FT
IV Pole/Holder	340.00	PL
Moisture Barrier	69.00	MB
Wood Arm Cap	225.00	WA
Black Arm Cap	172.00	PA
AC Motor Assist Mech	400.00	MT
Battery Powered Motor Assi	700.00	MTB
Heat & Massage	1,367.00	HM
3" Casters, Haley	255.00	C
Black Push Bar	159.00	BB
Aluminum Push Bar	296.00	PB
Oxygen Tank Holder	186.00	OX

FREIGHT CLASS: 150  
CUBIC FT: 39  
SHIP WEIGHT: 142

QS

**841 Haley Recliner, Trendelenburg**

29.25" W X 37.5" D X 46.75" H

St. Yardage: 6.5

SIN #711-16



Grade	1	2	3	4	5	6	7	8	9	10	L	LL
Zone 1	2249	2331	2426	2531	2620	2738	2857	2975	3094	3242	3431	3891
Zone 2	2283	2366	2462	2569	2659	2779	2900	3020	3140	3291	3482	3949
Zone 3	2316	2401	2499	2607	2699	2820	2943	3064	3187	3339	3534	4008

- 70" Depth when reclined
- 3 position push arm mechanism
- Includes Trendelenburg tilt which allows a 3° negative pitch operated by foot peddle on side of chair
- Full length foot rest supports entire leg
- Push bar option should only be ordered if ordering optional 3" casters
- Rated to 350 lbs
- Seat: 20.75"W x 20"D x 20"H

OPTION	PRICE	CODE
Softer Seat Foam-Chair	16.00	SF
Dbi Pivot Tablet	626.00	DPS
Pivoting Tablet	467.00	LPT
Folding Tablet	285.00	FT
IV Pole/Holder	340.00	PL
Moisture Barrier	69.00	MB
Wood Arm Cap	225.00	WA
Black Arm Cap	172.00	PA
Heat & Massage	1,367.00	HM
3" Casters, Haley	255.00	C
Black Push Bar	159.00	BB
Aluminum Push Bar	296.00	PB
Oxygen Tank Holder	186.00	OX

FREIGHT CLASS: 150  
CUBIC FT: 39  
SHIP WEIGHT: 142

QS

**843 Haley Bariatric Recliner**

33" W X 37.5" D X 46.75" H

St. Yardage: 7

SIN #711-16

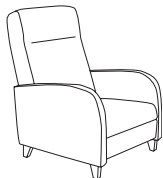

Grade	1	2	3	4	5	6	7	8	9	10	L	LL
Zone 1	2134	2225	2331	2446	2544	2675	2806	2938	3069	3233	3447	4282
Zone 2	2166	2258	2366	2483	2582	2715	2848	2982	3115	3281	3499	4346
Zone 3	2198	2292	2401	2519	2620	2755	2890	3026	3161	3330	3550	4410

- 70" Depth when reclined
- 3 position push arm mechanism
- Full length foot rest supports entire leg
- Push bar option should only be ordered if ordering optional 3" casters
- Rated to 500 lbs
- Seat: 24.5"W x 20"D x 20"H

OPTION	PRICE	CODE
Softer Seat Foam-Chair	16.00	SF
Dbi Pivot Tablet	626.00	DPS
Pivoting Tablet	467.00	LPT
Folding Tablet	285.00	FT
IV Pole/Holder	340.00	PL
Moisture Barrier	69.00	MB
Wood Arm Cap	225.00	WA
Black Arm Cap	172.00	PA
AC Motor Assist Mech	400.00	MT
Battery Powered Motor Assi	700.00	MTB
Heat & Massage	1,367.00	HM
3" Casters, Haley	255.00	C
Black Push Bar	159.00	BB
Aluminum Push Bar	296.00	PB
Oxygen Tank Holder	186.00	OX

FREIGHT CLASS: 150  
CUBIC FT: 45  
SHIP WEIGHT: 175

QS

ALL FOAM & FABRICS USED ARE CAL 117 APPROVED

QS indicates a Quickship item if ordered in Quickship upholstery. Quick Ship is not available on any item ordered with options.

HEALTHCARE

### 844 Haley Recliner, Trendelenburg, Pillow Back

29.25" W X 37.5" D X 46.75" H

St. Yardage: 7.25

SIN #711-16



Grade	1	2	3	4	5	6	7	8	9	10	L	LL
Zone 1	2429	2517	2620	2734	2830	2959	3087	3216	3344	3505	3709	4233
Zone 2	2465	2555	2659	2775	2872	3003	3133	3264	3394	3558	3765	4296
Zone 3	2502	2593	2699	2816	2915	3048	3180	3312	3444	3610	3820	4360

- 70" Depth when reclined
- 3 position push arm mechanism
- Includes Trendelenburg tilt which allows a 3° negative pitch operated by foot peddle on side of chair
- Pillow back with repositionable pillow
- Full length foot rest supports entire leg
- Push bar option should only be ordered if ordering optional 3" casters
- Rated to 350 lbs
- Seat: 20.75"W x 20"D x 20"H

OPTION	PRICE	CODE
Softer Seat Foam-Chair	16.00	SF
Dbi Pivot Tablet	626.00	DPS
Pivoting Tablet	467.00	LPT
Folding Tablet	285.00	FT
IV Pole/Holder	340.00	PL
Moisture Barrier	69.00	MB
Wood Arm Cap	225.00	WA
Black Arm Cap	172.00	PA
3" Casters, Haley	255.00	C
Black Push Bar	159.00	BB
Aluminum Push Bar	296.00	PB
Oxygen Tank Holder	186.00	OX

FREIGHT CLASS: 150  
 CUBIC FT: 39  
 SHIP WEIGHT: 142

**QS**

### 845 Haley Recliner, Pillow Back

29" W X 37.5" D X 46.75" H

St. Yardage: 8.5

SIN #711-16

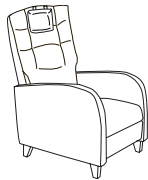

Grade	1	2	3	4	5	6	7	8	9	10	L	LL
Zone 1	2156	2240	2337	2445	2537	2658	2780	2902	3024	3176	3367	4151
Zone 2	2188	2274	2372	2482	2575	2698	2822	2946	3069	3224	3418	4213
Zone 3	2221	2307	2407	2518	2613	2738	2863	2989	3115	3271	3468	4276

- 70" Depth when reclined
- 3 position push arm mechanism
- Full length foot rest supports entire leg
- Includes pillow back with extra repositionable pillow
- Push bar option should only be ordered if ordering optional 3" casters
- Rated to 350 lbs
- Seat: 20.75"W x 20"D x 20"H

OPTION	PRICE	CODE
Softer Seat Foam-Chair	16.00	SF
Dbi Pivot Tablet	626.00	DPS
Pivoting Tablet	467.00	LPT
Folding Tablet	285.00	FT
IV Pole/Holder	340.00	PL
Moisture Barrier	69.00	MB
Wood Arm Cap	225.00	WA
Black Arm Cap	172.00	PA
AC Motor Assist Mech	400.00	MT
Battery Powered Motor Assi	700.00	MTB
3" Casters, Haley	255.00	C
Black Push Bar	159.00	BB
Aluminum Push Bar	296.00	PB
Oxygen Tank Holder	186.00	OX

FREIGHT CLASS: 150  
 CUBIC FT: 39  
 SHIP WEIGHT: 142

**QS**

### 847 Haley Bariatric Recliner, Pillow Back

33" W X 37.5" D X 46.75" H

St. Yardage: 9.25

SIN #711-16

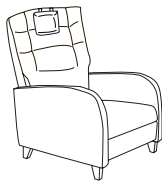

Grade	1	2	3	4	5	6	7	8	9	10	L	LL
Zone 1	2349	2440	2545	2683	2788	2929	3069	3210	3350	3526	3662	4651
Zone 2	2384	2477	2583	2723	2830	2973	3115	3258	3400	3579	3717	4721
Zone 3	2419	2513	2621	2763	2872	3017	3161	3306	3451	3632	3772	4791

- Same features as 843 except
- Pillow back with extra repositionable pillow

OPTION	PRICE	CODE
Softer Seat Foam-Chair	16.00	SF
Dbi Pivot Tablet	626.00	DPS
Pivoting Tablet	467.00	LPT
Folding Tablet	285.00	FT
IV Pole/Holder	340.00	PL
Moisture Barrier	69.00	MB
Wood Arm Cap	225.00	WA
Black Arm Cap	172.00	PA
AC Motor Assist Mech	400.00	MT
Battery Powered Motor Assi	700.00	MTB
3" Casters, Haley	255.00	C
Black Push Bar	159.00	BB
Aluminum Push Bar	296.00	PB
Oxygen Tank Holder	186.00	OX







FREIGHT CLASS: 150  
 CUBIC FT: 45  
 SHIP WEIGHT: 175

**QS**

FINISH SELECTION

ASPEN **AP** | BLACK **BLK** | NATURAL **FM** | HONEY CHERRY **HCY** | ROUGE MAHOGANY **RM** | MAHOGANY **MAH** | MOAB **MOB** | PEARWOOD **PW** | WALNUT **WAL** | WINDSOR CHERRY **WC** | CLASSIC CHERRY **CCY** | ESPRESSO **ESP** |

SIN VARIOUS **OPTIONS**

Options		Zone Pricing	1	2	3	
<b>PB Aluminum Push Bar</b> 	<ul style="list-style-type: none"> <li>• Brushed aluminum with black textured grip for easy patient relocation</li> <li>• Must be factory installed</li> </ul>	24" W X 4.5" D X 1" H	St. Yardage: n/a	<b>296</b>	<b>296</b>	<b>296</b>
	FREIGHT CLASS: 70 CUBIC FT: SHIP WEIGHT: 3	<b>SIN #711-16</b>				
<b>BB Black Push Bar</b> 	<ul style="list-style-type: none"> <li>• Black powder coated steel for easy patient relocation</li> <li>• Must be factory installed</li> </ul>	24" W X 4.5" D X 1" H	St. Yardage: n/a	<b>159</b>	<b>159</b>	<b>159</b>
	FREIGHT CLASS: 70 CUBIC FT: SHIP WEIGHT: 3	<b>SIN #711-16</b>				
<b>DPS Double Pivoting Tablet Arm</b> 	<ul style="list-style-type: none"> <li>• Cobra mounted black tablet arm</li> <li>• Brushed aluminum double articulating mechanism</li> <li>• Located on outside of arm, left facing standard</li> <li>• Must be factory installed</li> <li>• Tension adjustment for pivot</li> </ul>	24" W X 7" D X 7.25" H	St. Yardage: n/a	<b>626</b>	<b>626</b>	<b>626</b>
	FREIGHT CLASS: 70 CUBIC FT: SHIP WEIGHT: 7	<b>SIN #711-16</b>		Finish Options for Tablet: Mahogany (MAH), Windsor Cherry (WC), Classic Cherry (CCY), Walnut (WAL), Honey Cherry (HCY), Natural (FM), Aspen (AP), Moab (MOB), Pearwood (PW) and Rouge Mahogany (RM)		
<b>LPT Large Pivoting Tablet Arm with Cobra Mount</b> 	<ul style="list-style-type: none"> <li>• Cobra mounted black tablet arm</li> <li>• Brushed aluminum single pivot mechanism</li> <li>• Located on outside of arm, left facing standard</li> <li>• Tension adjustment for pivot</li> <li>• Must be factory installed</li> </ul>	27" W X 9.5" D X 7.25" H	St. Yardage: n/a	<b>467</b>	<b>467</b>	<b>467</b>
	FREIGHT CLASS: 70 CUBIC FT: SHIP WEIGHT: 6	<b>SIN #711-16</b>		Finish Options for Tablet: Mahogany (MAH), Windsor Cherry (WC), Classic Cherry (CCY), Walnut (WAL), Honey Cherry (HCY), Natural (FM), Aspen (AP), Moab (MOB), Pearwood (PW) and Rouge Mahogany (RM)		
<b>FT Folding Side Table for Recliners</b> 	<ul style="list-style-type: none"> <li>• Easily locks in place</li> <li>• Folds down flat</li> <li>• Located on outside of arm, right side facing standard</li> <li>• Pneumatic back release will need to relocate to left arm facing or inside arm on chairs with folding side table</li> <li>• Must be factory installed</li> </ul>	11.75" W X 21.5" D X 8.5" H	St. Yardage: n/a	<b>285</b>	<b>285</b>	<b>285</b>
	FREIGHT CLASS: 70 CUBIC FT: SHIP WEIGHT: 6	<b>SIN #711-16</b>		Finish Options for Tablet: Mahogany (MAH), Windsor Cherry (WC), Classic Cherry (CCY), Walnut (WAL), Honey Cherry (HCY), Natural (FM), Aspen (AP), Moab (MOB), Pearwood (PW) and Rouge Mahogany (RM)		
<b>PL IV Pole with Pole Holder</b> 	<ul style="list-style-type: none"> <li>• Two prong IV pole</li> <li>• Chrome plated steel</li> <li>• Adjustable height 55.5" x 90.5"</li> <li>• Locking collar prevents accidental collapse</li> <li>• Brushed aluminum cobra-mount pole holder located on outside bottom rear of chair arm, right side facing standard</li> <li>• Must be factory installed</li> </ul>	11" W X 2.75" D X 55.5-90.5" H	St. Yardage: n/a	<b>340</b>	<b>340</b>	<b>340</b>
	FREIGHT CLASS: 70 CUBIC FT: SHIP WEIGHT: 5	<b>SIN #711-16</b>				

HEALTHCARE

**ALL FOAM & FABRICS USED ARE CAL 117 APPROVED**  
**QS** indicates a Quickship item if ordered in Quickship upholstery. Quick Ship is not available on any item ordered with options.

# OPTIONS SIN VARIOUS

## FINISH SELECTION

ASPEN **AP** | BLACK **BLK** | NATURAL **FM** | HONEY CHERRY **HCY** | ROUGE  
 MAHOGANY **RM** | MAHOGANY **MAH** | MOAB **MOB** | PEARWOOD **PW** | WALNUT  
**WAL** | WINDSOR CHERRY **WC** | CLASSIC CHERRY **CCY** | ESPRESSO **ESP** |

### HEALTHCARE



		Zone Pricing	1	2	3
<b>MB Moisture Barrier</b>	<ul style="list-style-type: none"> <li>Moisture barrier between seat foam and fabric</li> <li>70 Denier/210 thread count nylon with polyurethane coating</li> <li>Anti bacterial, antifungal inhibition 99+%</li> </ul>	St. Yardage: n/a	69	69	69
	FREIGHT CLASS: 70 CUBIC FT: SHIP WEIGHT:	<b>SIN #711-16</b>			
<b>MT AC Powered Motor Assist</b>	<ul style="list-style-type: none"> <li>Motorized mechanism for a smooth recline and return</li> <li>Operated through wired remote control</li> <li>Specify MT at end of model number</li> <li>Must be factory installed</li> </ul>	St. Yardage: n/a	400	400	400
	FREIGHT CLASS: CUBIC FT: SHIP WEIGHT:				
<b>MTB Battery Powered Motor Assist</b>	<ul style="list-style-type: none"> <li>Motorized mechanism for a smooth recline and return</li> <li>Operated through battery powered remote control</li> <li>Specify MTB at end of model number</li> <li>Must be factory installed</li> </ul>	St. Yardage: n/a	700	700	700
	FREIGHT CLASS: CUBIC FT: SHIP WEIGHT:				
<b>HM Heat &amp; Massage for Recliner</b>	<ul style="list-style-type: none"> <li>AC powered heat and massage operated through push button</li> <li>Control located on inside of right arm facing, standard</li> <li>Will not overheat</li> <li>Waterproof</li> <li>Not available on pillow back models</li> <li>Must be factory installed</li> </ul>	St. Yardage: n/a	1367	1367	1367
	FREIGHT CLASS: CUBIC FT: SHIP WEIGHT:				
<b>WA Wood Arm Caps for Recliners</b>	<ul style="list-style-type: none"> <li>Set of two finished wood arm caps</li> <li>Pre-installed</li> <li>Specify WA at end of model number and indicate finish</li> </ul>	23.25" W X 2.75" D X 1" H St. Yardage: n/a	225	225	225
	FREIGHT CLASS: 70 CUBIC FT: SHIP WEIGHT: 15	<b>SIN #711-16</b> Aspen (AP), Natural (FM), Honey Cherry (HC), Rouge Mahogany (R), Mahogany (MAH), Moab (MOB), Pearwood (PW), Walnut (WAL), Windsor Cherry (WC), Claswic cherry (CCY), Espresso (ESP)			
<b>PA Black Polyurethane Arm Caps</b>	<ul style="list-style-type: none"> <li>Set of two black polyurethane arm caps for recliners</li> <li>Pre-installed</li> <li>Specify PA at end of model number</li> </ul>	23.25" W X 2.75" D X 1" H St. Yardage: n/a	172	172	172
	FREIGHT CLASS: 70 CUBIC FT: SHIP WEIGHT: 12	<b>SIN #711-16</b>			

FINISH SELECTION

ASPEN **AP** | BLACK **BLK** | NATURAL **FM** | HONEY CHERRY **HCY** | ROUGE  
 MAHOGANY **RM** | MAHOGANY **MAH** | MOAB **MOB** | PEARWOOD **PW** | WALNUT  
**WAL** | WINDSOR CHERRY **WC** | CLASSIC CHERRY **CCY** | ESPRESSO **ESP** |

SIN VARIOUS **OPTIONS**

HEALTHCARE

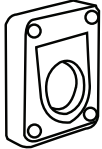
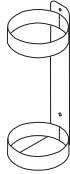
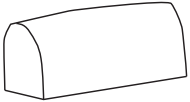
		Zone Pricing	1	2	3			
<b>RA Brushed Aluminum Footrest Lever</b> 	<ul style="list-style-type: none"> <li>• Optional brushed aluminum footrest lever with black textured grip to replace standard black lever on Hannah recliners</li> <li>• Specify RA at end of model number</li> </ul>	St. Yardage: n/a	216	216	216			
	FREIGHT CLASS: 70 CUBIC FT: SHIP WEIGHT: 6	<b>SIN #711-16</b>						
<b>C Optional 3" Casters for Haley Recliner</b> 	<ul style="list-style-type: none"> <li>• 3" non-marking twin wheel casters</li> <li>• Front casters lock</li> <li>• Mounted with metal plate</li> <li>• Add C at the end of any Haley recliner model number</li> <li>• Must be factory installed</li> </ul>	St. Yardage: n/a	255	255	255			
	FREIGHT CLASS: 70 CUBIC FT: SHIP WEIGHT: 11	<b>SIN #711-16</b>						
<b>FH Foley/Accessory Hook</b> 	<ul style="list-style-type: none"> <li>• Accessory hook located outside right arm facing standard</li> <li>• Provides convenient placement for drainage bags</li> <li>• Useful in securing restraints</li> <li>• Must be factory installed</li> </ul>	St. Yardage: n/a	100	100	100			
	FREIGHT CLASS: 70 CUBIC FT: SHIP WEIGHT:							
<b>Oxygen Tank Holder</b> 	<ul style="list-style-type: none"> <li>• Holds size D oxygen tank</li> <li>• Stainless Steel</li> <li>• Located outside right arm facing standard</li> <li>• Must be factory installed</li> </ul>	St. Yardage: n/a	186	186	186			
	FREIGHT CLASS: 70 CUBIC FT: SHIP WEIGHT: 1							
<b>Clear Headrest Covers</b> 	<ul style="list-style-type: none"> <li>• Box of 5 clear headrest covers for recliners</li> <li>• H30HC - fits 830 and 831 recliners</li> <li>• H33HC - fits 832 and 833 recliners</li> <li>• H40HC - fits 810, 840 and 841 recliners</li> <li>• H43HC - fits 843 recliner</li> </ul>							
		<b>830HC</b>	25" x 7.5" x 27"	Cubic Ft: 6	Ship Weight: 8	<b>333</b>	<b>338</b>	<b>343</b>
		<b>833HC</b>	30" x 7.5" x 27"	Cubic Ft: 6	Ship Weight: 8	<b>333</b>	<b>338</b>	<b>343</b>
		<b>840HC</b>	21.5" x 7.5" x 27"	Cubic Ft: 6	Ship Weight: 8	<b>333</b>	<b>338</b>	<b>343</b>
		<b>843HC</b>	25.5" x 7.5" x 27"	Cubic Ft: 6	Ship Weight: 8	<b>333</b>	<b>338</b>	<b>343</b>
	FREIGHT CLASS: 70							

ALL FOAM & FABRICS USED ARE CAL 117 APPROVED

**QS** indicates a Quickship item if ordered in Quickship upholstery. Quick Ship is not available on any item ordered with options.

# HARMONY DAY BEDS SIN 711-16

HEALTHCARE

## Overnight Comfort

**Harmony** is the ideal answer for an overnight, comfortable stay in a patient room. It is available in three widths to accommodate most rooms.

The full size version of Harmony provides an adequate sleeping space with room for two adults - perfect for an overnight stay in a children's facility.

## Harmony Features

- Wall-saver design
- Lift the front of seat and pull out base to convert to a 78" bed
- Lift chair back and roll forward to close and lock, converts unit back to chair
- Ample storage under seat for sheets, pillows, blankets, etc.
- Platform rail on glides for stability
- Rollers on front for easy opening

## Warranty

- Limited lifetime on seating components.
- Three years on recliner mechanism.



Open position

## Harmony Day Beds

### 821 Single Convertible Seat/Day Bed

38.5" W X 39-78" D X 35" H

St. Yardage: 7.5

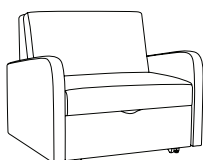

FREIGHT CLASS: 150  
CUBIC FT: 38  
SHIP WEIGHT: 193

Grade	1	2	3	4	5	6	7	8	9	10	L	LL
Zone 1	2601	2709	2835	2953	3064	3212	3361	3509	3657	3842	4162	5028
Zone 2	2640	2750	2878	2997	3110	3260	3411	3562	3712	3900	4224	5103
Zone 3	2679	2790	2920	3042	3156	3308	3462	3614	3767	3957	4287	5179

- Club chair easily converts to single size bed
- Platform rail on glides for stability
- Rollers on front for easy opening
- See instructions above for operation
- Seat: 30.75"W x 22.5"D x 18"H

OPTION	PRICE	CODE
Softer Seat Foam-Chair	16.00	SF
Wood Arm Cap	225.00	WA
Black Arm Cap	172.00	PA

### 822 Twin Size Convertible Seat/Day Bed

46.5" W X 39-78" D X 35" H

St. Yardage: 8.5



FREIGHT CLASS: 150  
CUBIC FT: 39  
SHIP WEIGHT: 200

Grade	1	2	3	4	5	6	7	8	9	10	L	LL
Zone 1	2984	3099	3233	3383	3509	3677	3845	4013	4181	4391	4647	5735
Zone 2	3029	3145	3281	3434	3562	3732	3903	4073	4244	4457	4717	5821
Zone 3	3074	3192	3330	3484	3614	3787	3960	4133	4306	4523	4786	5907

- Loveseat easily converts to twin size bed
- Platform rail on glides for stability
- Rollers on front for easy opening
- See instructions above for operation
- Seat: 38.5"W x 22.5"D x 18"H

OPTION	PRICE	CODE
Softer Seat Foam-Loveseat	32.00	SF
Wood Arm Cap	225.00	WA
Black Arm Cap	172.00	PA



# SIN 711-16 HARMONY DAY BEDS

HEALTHCARE

## 823 Full Convertible Seat/Day Bed

55" W X 39-78" D X 35" H

St. Yardage: 9.5

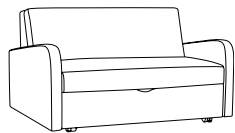

FREIGHT CLASS: 150  
CUBIC FT: 56  
SHIP WEIGHT: 251

Grade	1	2	3	4	5	6	7	8	9	10	L	LL
Zone 1	3484	3613	3764	3930	4071	4258	4446	4634	4822	5056	5356	6558
Zone 2	3536	3667	3820	3989	4132	4322	4513	4704	4894	5132	5436	6656
Zone 3	3589	3721	3877	4048	4193	4386	4579	4773	4967	5208	5517	6755

- Sofa easily converts to full size bed
- Platform rail on glides for stability
- Rollers on front for easy opening
- See instructions above for operation
- Seat: 47.25"W x 22.5"D x 18"H

OPTION	PRICE	CODE
Softer Seat Foam-Sofa	48.00	SF
Wood Arm Cap	225.00	WA
Black Arm Cap	172.00	PA

## 826 Harmony Sleeper Chair

35.75" W X 37" D X 35" H

St. Yardage: 9.25

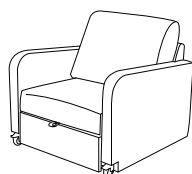

FREIGHT CLASS: 150  
CUBIC FT: 40  
SHIP WEIGHT: 168

Grade	1	2	3	4	5	6	7	8	9	10	L	LL
Zone 1	2680	2806	2952	3114	3251	3434	3617	3800	3982	4211	4502	5673
Zone 2	2720	2848	2997	3161	3300	3486	3671	3857	4042	4274	4570	5758
Zone 3	2760	2890	3041	3207	3349	3537	3726	3914	4101	4337	4637	5843

- Comfortable club chair with easy pop-up ottoman
- Chair by day and sleeper by night
- The pull-out ottoman extends from the back for added length
- Back cushion folds down to convert to a pillow height mattress extension
- 4 heavy-duty casters for easy mobility (front 2 lock)
- Seat: 27"W x 20"D x 17"H

OPTION	PRICE	CODE
Softer Seat Foam-Chair	16.00	SF
Wood Arm Cap	225.00	WA
Black Arm Cap	172.00	PA

## 826-2 Tandem Sleeper Chair

64.75" W X 37" D X 35" H

St. Yardage: 18.5

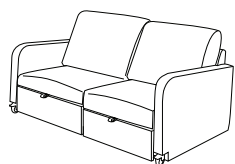

FREIGHT CLASS: 150  
CUBIC FT: 82  
SHIP WEIGHT: 282

Grade	1	2	3	4	5	6	7	8	9	10	L	LL
Zone 1	5360	5611	5905	8228	6502	6868	7234	7600	7964	8422	9005	11346
Zone 2	5440	5695	5994	8351	6600	6971	7343	7714	8083	8548	9140	11516
Zone 3	5521	5779	6082	8475	6697	7074	7451	7828	8203	8675	9275	11686

- Dual sleeper chairs
- Each seat operates independently
- Easy pop-up and retractable ottomans
- Pull-out ottomans extend from the back for added length
- Back cushions fold down to convert to pillow height mattress extension
- Heavy-duty casters for mobility
- Front casters lock
- Each seat: 27"W x 20"D x 17"H

OPTION	PRICE	CODE
Softer Seat Foam-Loveseat	32.00	SF
Wood Arm Cap	225.00	WA
Black Arm Cap	172.00	PA

## 8233 Sofa/Bed

80.5" W X 34.5" D X 33" H

St. Yardage: 13.5

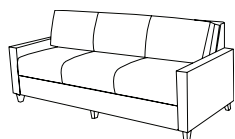

FREIGHT CLASS: 150  
CUBIC FT: 81  
SHIP WEIGHT: 221

Grade	1	2	3	4	5	6	7	8	9	10	L	LL
Zone 1	3327	3509	3720	3937	4130	4387	4644	4901	5158	5479	5952	7534
Zone 2	3377	3562	3776	3996	4192	4453	4714	4975	5235	5561	6041	7647
Zone 3	3427	3614	3832	4055	4254	4519	4783	5048	5313	5643	6131	7760

- Wood legs
- Attached pillow back unfolds to convert to mattress
- Refold back to convert back into sofa
- Seat: 71.5"W x 19"D x 22"H

OPTION	PRICE	CODE
Softer Seat Foam-Sofa	48.00	SF
Wood Arm Cap	259.00	WA
Black Arm Cap	209.00	PA

ALL FOAM & FABRICS USED ARE CAL 117 APPROVED

**QS** indicates a Quickship item if ordered in Quickship upholstery. Quick Ship is not available on any item ordered with options.

# HARMONY DAY BEDS SIN 711-16

HEALTHCARE

## 8233D Sofa/Bed with Laminate Drawers

80.5" W X 34.5" D X 33" H

St. Yardage: 13.5

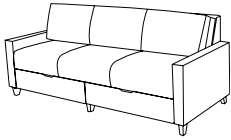

FREIGHT CLASS: 150  
CUBIC FT: 81  
SHIP WEIGHT: 242

Grade	1	2	3	4	5	6	7	8	9	10	L	LL
Zone 1	3732	3913	4125	4342	4535	4792	5049	5306	5563	5884	6357	7939
Zone 2	3788	3972	4187	4407	4603	4864	5125	5386	5646	5972	6452	8058
Zone 3	3844	4030	4249	4472	4671	4936	5200	5465	5730	6061	6548	8177

- Two drawers in base with laminate fronts
- Drawer fronts available in Hyperwork finishes to match wood legs
- Ample storage for sheets, blankets and pillows
- Attached pillow back unfolds to convert to mattress
- Refold back to convert back into sofa
- Seat: 71.5"W x 19"D x 22"H

OPTION	PRICE	CODE
Softer Seat Foam-Sofa	48.00	SF
Wood Arm Cap	259.00	WA
Black Arm Cap	209.00	PA

## 8233UD Sofa/Bed with Upholstered Drawer

80.5" W X 34.5" D X 33" H

St. Yardage: 14

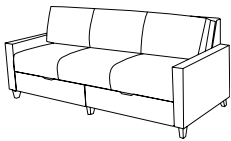

FREIGHT CLASS: 150  
CUBIC FT: 81  
SHIP WEIGHT: 242

Grade	1	2	3	4	5	6	7	8	9	10	L	LL
Zone 1	3732	3913	4125	4342	4535	4792	5049	5306	5563	5884	6357	7939
Zone 2	3788	3972	4187	4407	4603	4864	5125	5386	5646	5972	6452	8058
Zone 3	3844	4030	4249	4472	4671	4936	5200	5465	5730	6061	6548	8177

- Two drawers in base with upholstered fronts
- Ample storage for sheets, blankets and pillows
- Attached pillow back unfolds to convert to mattress
- Refold back to convert back into sofa
- Seat: 71.5"W x 19"D x 22"H

OPTION	PRICE	CODE
Softer Seat Foam-Sofa	48.00	SF
Wood Arm Cap	259.00	WA
Black Arm Cap	209.00	PA

**Comfort for Physicians**

**Helix** provides a full range of adjustable height seating for physicians' offices, examination rooms and other areas of care. Most models include a foot activated ring in the base to provide a hands-free height adjustment. Braking casters on those models also ensure that the stool does not roll away when sitting down or getting up. Both of these features allow the user to keep hands clean and sterile.

Model **581** includes a back rest to ensure proper lumbar support.

Model **582** features a molded urethane seat and black base with a hand-lever height adjustment for ergonomic application.

Select from hundreds of standard and thousands of other available upholsteries including easy-to-clean vinyls and woven Cryptons.

**Helix Details**

- *Dual-wheel, braking casters on 580 & 581 inhibits movement when stool is vacant*
- *Foot-activated, hands-free pneumatic height adjustment on 580 & 581 stools*
- *Hand-activated pneumatic height adjustment on 582*
- *Choice of Black or Chrome bases with or without back rest*



**581CB with lumbar support**



**580CB**



**582 with urethane seat**

**Helix Dr. Stools**

**580 Helix Dr. Stool, Black Base**

26" W X 26" D X 22.5-29.75" H St. Yardage: 1.5



FREIGHT CLASS: 150  
CUBIC FT: 11  
SHIP WEIGHT: 27

Grade	1	2	3	4	5	6	7	8	9	10	L	LL
<b>Zone 1</b>	521	541	566	591	614	643	673	703	732	769	824	1006
<b>Zone 2</b>	529	549	574	600	623	653	683	714	743	781	836	1021
<b>Zone 3</b>	537	557	583	609	632	662	693	724	754	792	849	1036

- Black base
- Upholstered seat
- Braking casters
- Foot activated pneumatic height adjustment
- Ships fully assembled
- Seat: 16" Diameter, 22.5-29.75"H

OPTION	PRICE	CODE
Hard-Floor Casters	19.00	H
Glides/Replace Casters	N/C	GL

**QS**

**580CB Helix Dr. Stool, Chrome Base**

26" W X 26" D X 22.5-29.75" H St. Yardage: 1.5



FREIGHT CLASS: 150  
CUBIC FT: 11  
SHIP WEIGHT: 27

Grade	1	2	3	4	5	6	7	8	9	10	L	LL
<b>Zone 1</b>	552	573	598	622	645	674	704	734	763	800	856	1037
<b>Zone 2</b>	560	582	607	631	655	684	715	745	774	812	869	1053
<b>Zone 3</b>	569	590	616	641	664	694	725	756	786	824	882	1068

- Chrome base
- Upholstered seat
- Braking casters
- Foot activated pneumatic height adjustment
- Ships fully assembled
- Seat: 16" Diameter, 22.5-29.75"H

OPTION	PRICE	CODE
Hard-Floor Casters	19.00	H
Glides/Replace Casters	N/C	GL

**QS**

# HELIX DR. STOOLS SIN 711-16

HEALTHCARE

## 581 Helix Dr. Stool, Black with Lumbar Support

26" W X 26" D X 37-44" H

St. Yardage: 1.5



Grade	1	2	3	4	5	6	7	8	9	10	L	LL
Zone 1	640	660	685	710	733	762	792	822	851	888	943	1125
Zone 2	650	670	695	721	744	773	804	834	864	901	957	1142
Zone 3	659	680	706	731	755	785	816	847	877	915	971	1159

- Black base
- Upholstered seat and lumbar support
- Braking casters
- Foot activated pneumatic height adjustment
- Simple assembly by attaching back
- Seat: 16" Diameter, 22.5-29.75"H

OPTION	PRICE	CODE
Hard-Floor Casters	19.00	H
Glides/Replace Casters	N/C	GL

FREIGHT CLASS: 150  
CUBIC FT: 11  
SHIP WEIGHT: 33

QS

## 581CB Helix Dr. Stool, Chrome with Lumbar Support

26" W X 26" D X 37-44" H

St. Yardage: 1.5

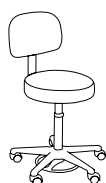

Grade	1	2	3	4	5	6	7	8	9	10	L	LL
Zone 1	675	696	721	745	768	797	827	857	886	923	979	1160
Zone 2	685	706	732	756	780	809	839	870	899	937	994	1177
Zone 3	695	717	743	767	791	821	852	883	913	951	1008	1195

- Chrome base
- Upholstered seat
- Braking casters
- Foot activated pneumatic height adjustment
- Simple assembly by attaching back
- Seat: 16" Diameter, 22.5-29.75"H

OPTION	PRICE	CODE
Hard-Floor Casters	19.00	H
Glides/Replace Casters	N/C	GL

FREIGHT CLASS: 150  
CUBIC FT: 11  
SHIP WEIGHT: 33

QS

## 582 Helix Dr. Stool, Urethane Seat

- Black base
- Black urethane seat
- Hand activated pneumatic height adjustment
- Ships fully assembled
- Seat: 14" Diameter, 14.5-20"H



FREIGHT CLASS: 150

Zone Pricing	1	2	3
--------------	---	---	---

QS	24" x 24" x 14.5-20"	Cubic Ft: 11	Ship Weight: 16	192	195	198
----	----------------------	--------------	-----------------	-----	-----	-----

OPTION	PRICE	CODE
Braking Casters	30.00	B
Glides/Replace Casters	N/C	GL

## FINISH SELECTION

NATURAL MAPLE **FM** | ASPEN **AP** | PEARWOOD **PW** |  
WINDSOR CHERRY **WC** | MAHOGANY **M** | MEDIUM OAK **O** |  
ESPRESSO **X** | CLASSIC CHERRY **CC** | BLACK **E** | GREY **G** |

SIN 71-204 **PRAXIS**

HEALTHCARE



### CHARACTERISTICS

Modular Wall Storage System  
Open and Enclosed Storage  
Wardrobe Coat Rod Options  
Small, Medium and Large Drawers  
4 Drawer/Door Pull Options  
Adjustable Floor Glides  
Fixed and Adjustable Shelves  
Freestanding and Return Desk Options  
Upholstered Cushion Options

### FINISH CHOICES

Praxis is available in eight finishes. The color choices are **Natural Maple, Aspen, Pearwood, Windsor Cherry, Mahogany, Medium Oak, Espresso, Black, Grey** and **Classic Cherry** laminate.

### PULLS: STANDARD

Sleek, curvilinear drawer/door pulls are solid metal and available in Brushed Chrome (W), Ebony (E), Bright Brass (B) or Oval Nickel (D) for design flexibility.

### SPECIFICATIONS *Drawers*

All cases are  $\frac{3}{4}$ " thick core with thermally fused laminate on both sides. Units are fully assembled with dowels, glue, metal brackets, screws and mechanical fasteners. Tops are  $\frac{3}{4}$ " thick except on night stand which has a 1" thick top.

### DRAWERS

Drawer fronts are constructed of  $\frac{3}{4}$ " thick core with thermally fused laminate on both sides. Drawers are constructed with 5 sides for extra strength and durability. The drawer front is the 5th side and is removable in the field for repairs.

- Drawers are suspended on heavy-duty, ball bearing full-extension slides
- PROFile filing hardware is available for file or lateral file size drawers for field installation

### PACKAGING

All units are properly packed in heavy-duty cartons with reinforced corner pads. All packaging conforms to, or exceeds, specifications as outlined in the Uniform Freight Classification.

### PALLETIZATION

See page 3.

### CARE & CLEANING

Normal cleaning: Clean using a soft cloth and a good window cleaner which contains no ammonia, followed by wiping dry using a dry soft cloth.

**Specifications subject to change without notice.**

## Praxis Wall System

Zone Pricing

1

2

3

### Wardrobe/Drawer Storage

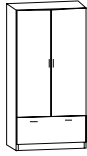

- Double wardrobe in top
- One full-width drawer in bottom

Freight Class: 125

**P\_\_72M1** 36" x 20" x 72" Cubic Ft: 39 Ship Weight: 267 **2039** **2070** **2100**

**Pulls:** BRUSHED CHROME **PW** EBONY **PE** BRIGHT BRASS **PB** OVAL NICKEL **PD**

### Seating/Storage Cabinet

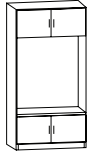

- 2 door storage in top
- 2 door storage in bottom
- Temporary seat in middle
- Seat cushions P36SBC and P36SC sold separate

Freight Class: 125

**P\_\_72M2** 36" x 20" x 72" Cubic Ft: 39 Ship Weight: 223 **1917** **1946** **1975**

**Pulls:** BRUSHED CHROME **PW** EBONY **PE** BRIGHT BRASS **PB** OVAL NICKEL **PD**

### Storage Cabinet

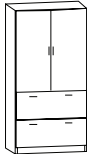

- Two adjustable shelves behind two doors in top
- Space behind doors: 34.5" x 18.25" x 40"
- Two full-width drawers in bottom

Freight Class: 125

**P\_\_72M3** 36" x 20" x 72" Cubic Ft: 39 Ship Weight: 275 **2318** **2353** **2388**

**Pulls:** BRUSHED CHROME **PW** EBONY **PE** BRIGHT BRASS **PB** OVAL NICKEL **PD**

### 2-Shelf/3-Drawer Storage



- Two full-width shelves in top
- Three full-width drawers in bottom
- Filing hardware available

Freight Class: 125

**P\_\_72M4** 36" x 20" x 72" Cubic Ft: 39 Ship Weight: 275 **2245** **2279** **2312**

**Pulls:** BRUSHED CHROME **PW** EBONY **PE** BRIGHT BRASS **PB** OVAL NICKEL **PD**

### Combo Open/Enclosed Cabinet



- Tall open storage and two small box drawers left
- One adjustable shelf in open area top right
- One adjustable shelf behind door middle right
- Full-width drawer in bottom

Freight Class: 125

**P\_\_72M5** 36" x 20" x 72" Cubic Ft: 39 Ship Weight: 291 **2478** **2515** **2552**

**Pulls:** BRUSHED CHROME **PW** EBONY **PE** BRIGHT BRASS **PB** OVAL NICKEL **PD**

### Desk Return Cabinet

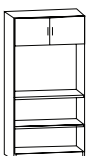

- Two-door storage in top
- One fixed shelf in center
- One adjustable shelf in bottom

Freight Class: 125

**P\_\_72M6** 36" x 20" x 72" Cubic Ft: 39 Ship Weight: 226 **1766** **1792** **1819**

**Pulls:** BRUSHED CHROME **PW** EBONY **PE** BRIGHT BRASS **PB** OVAL NICKEL **PD**

### Storage Cabinet



- Two open cube shelves in top
- Two tall open storage shelves middle
- Four cube drawers in bottom
- Filing hardware sold separate

Freight Class: 125

**P\_\_72M7** 36" x 20" x 72" Cubic Ft: 39 Ship Weight: 298 **2585** **2624** **2663**

**Pulls:** BRUSHED CHROME **PW** EBONY **PE** BRIGHT BRASS **PB** OVAL NICKEL **PD**



## FINISH SELECTION

NATURAL MAPLE **FM** | ASPEN **AP** | PEARWOOD **PW** |  
 WINDSOR CHERRY **WC** | MAHOGANY **M** | MEDIUM OAK **O** |  
 ESPRESSO **X** | CLASSIC CHERRY **CC** | BLACK **E** | GREY **G** |

SIN 71-204 **PRAXIS**

HEALTHCARE

### Storage Cabinet



- Three open shelves top left
- One adjustable shelf behind door on right
- Two cube drawers
- One full width drawer in bottom
- Filing hardware sold separate

Freight Class: 125

### Storage Cabinet



- Two-door storage top
- Two full-width shelves middle
- Two cube drawers
- One full-width drawer in bottom
- Filing hardware sold separate

Freight Class: 125

### Storage Cabinet



- Two-door storage in top
- Four open storage cubes in middle
- Four small/box drawers
- Two cube drawers in bottom
- Filing hardware sold separate

Freight Class: 125

### Storage Cabinet

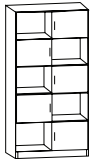

- Five each alternating door/open storage cubes

Freight Class: 125

### Storage Cabinet

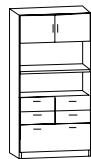

- Two-door storage in top
- Two full-width shelves in middle
- Four small/box drawers
- One full-width drawer in bottom
- Filing hardware sold separate

Freight Class: 125

### Storage Cabinet, 2 Doors, 1 Shelf, 1 Drawer

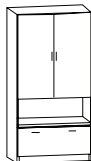

- Two adjustable shelves behind two doors in top
- One full width open shelf
- One full-width drawer in bottom

Freight Class: 125

### Floating Top Desk Return



- Thermo-fused laminate top
- Two "Floating Top" post legs
- PT\_4836SE = Black legs
- PT\_4836SM = Silver legs

Freight Class: 85

## Zone Pricing

1

2

3

**P\_72M8** 36" x 20" x 72" Cubic Ft: 39 Ship Weight: 298 **2640** **2680** **2719**

**Pulls:** BRUSHED CHROME **PW** EBONY **PE** BRIGHT BRASS **PB** OVAL NICKEL **PD**

**P\_72M9** 36" x 20" x 72" Cubic Ft: 39 Ship Weight: 297 **2507** **2545** **2582**

**Pulls:** BRUSHED CHROME **PW** EBONY **PE** BRIGHT BRASS **PB** OVAL NICKEL **PD**

**P\_72M10** 36" x 20" x 72" Cubic Ft: 39 Ship Weight: 298 **3114** **3161** **3207**

**Pulls:** BRUSHED CHROME **PW** EBONY **PE** BRIGHT BRASS **PB** OVAL NICKEL **PD**

**P\_72M11** 36" x 20" x 72" Cubic Ft: 39 Ship Weight: 298 **2301** **2336** **2370**

**Pulls:** BRUSHED CHROME **PW** EBONY **PE** BRIGHT BRASS **PB** OVAL NICKEL **PD**

**P\_72M12** 36" x 20" x 72" Cubic Ft: 39 Ship Weight: 298 **2858** **2901** **2944**

**Pulls:** BRUSHED CHROME **PW** EBONY **PE** BRIGHT BRASS **PB** OVAL NICKEL **PD**

**P\_72M17** 36" x 20" x 72" Cubic Ft: 39 Ship Weight: 255 **2295** **2329** **2364**

**Pulls:** BRUSHED CHROME **PW** EBONY **PE** BRIGHT BRASS **PB** OVAL NICKEL **PD**

**PT\_4836S** 48" x 36" x 29" Cubic Ft: 7 Ship Weight: 60 **702** **713** **723**

### Freestanding Floating Top Desk

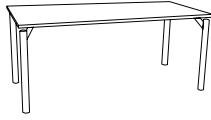

- Thermo-fused laminate top
- Four "floating top" post legs
- PT-6630E = Black legs
- PT-6630M = Silver legs

Freight Class: 85

Zone Pricing				1	2	3
<b>PT_6630</b>	66" x 30" x 29"	Cubic Ft: 12	Ship Weight: 92	<b>720</b>	<b>731</b>	<b>742</b>

### Filing Hardware Kits

- For field installation
- Includes file rails, adjustable cross bars and screws to install
- PFDKIT fits cube drawer
- PLFDKIT fits full-width drawer

Freight Class: 70

<b>PFDKIT</b>	16" x 16"	Cubic Ft: 1	Ship Weight: 3	<b>46</b>	<b>47</b>	<b>47</b>
<b>PLFDKIT</b>	33" x 16"	Cubic Ft: 1	Ship Weight: 3	<b>67</b>	<b>68</b>	<b>69</b>

### P36SC Seat Cushion for Wall System

34.75" W X 18.5" D X 2.75" H St. Yardage:

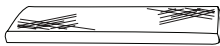

Grade	1	2	3	4	5	6	7	8	9	10	L	LL
<b>Zone 1</b>	<b>245</b>	<b>268</b>	<b>294</b>	<b>315</b>	<b>338</b>	<b>367</b>	<b>397</b>	<b>427</b>	<b>456</b>	<b>493</b>	<b>575</b>	<b>730</b>
<b>Zone 2</b>	<b>249</b>	<b>272</b>	<b>298</b>	<b>320</b>	<b>343</b>	<b>373</b>	<b>403</b>	<b>433</b>	<b>463</b>	<b>500</b>	<b>584</b>	<b>741</b>
<b>Zone 3</b>	<b>252</b>	<b>276</b>	<b>303</b>	<b>324</b>	<b>348</b>	<b>378</b>	<b>409</b>	<b>440</b>	<b>470</b>	<b>508</b>	<b>592</b>	<b>752</b>

FREIGHT CLASS: 100  
CUBIC FT: 6  
SHIP WEIGHT: 6

- Seat cushion for Praxis wall unit P\_72M2
- Can be ordered in any upholstery

### P36SBC Seat and Back Cushion for Wall System

34.75" W X 18.5" D X 19.75" H St. Yardage:

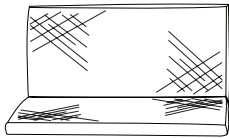

Grade	1	2	3	4	5	6	7	8	9	10	L	LL
<b>Zone 1</b>	<b>339</b>	<b>384</b>	<b>438</b>	<b>480</b>	<b>524</b>	<b>584</b>	<b>643</b>	<b>702</b>	<b>761</b>	<b>836</b>	<b>1000</b>	<b>1310</b>
<b>Zone 2</b>	<b>344</b>	<b>390</b>	<b>445</b>	<b>487</b>	<b>532</b>	<b>593</b>	<b>653</b>	<b>713</b>	<b>772</b>	<b>849</b>	<b>1015</b>	<b>1330</b>
<b>Zone 3</b>	<b>349</b>	<b>396</b>	<b>451</b>	<b>494</b>	<b>540</b>	<b>602</b>	<b>662</b>	<b>723</b>	<b>784</b>	<b>861</b>	<b>1030</b>	<b>1349</b>

FREIGHT CLASS: 100  
CUBIC FT: 6  
SHIP WEIGHT: 8

- Seat and back cushion for for Praxis wall unit P\_72M2
- Can be ordered in any upholstery

## Praxis Home

### Wardrobe Cabinet



- Hanging rod in wardrobe on right
- Mirror inside wardrobe door
- Locking drawer behind locking door on left
- Dome light inside locking door
- Two utility and one cube drawer bottom left
- Transitional style pulls
- Two open display/storage shelves in top
- Traditional dentil molding on three sides

Freight Class: 125

<b>PT_72H</b>	40.5" x 21" x 73"	Cubic Ft: 35.9	Ship Weight: 328	<b>3236</b>	<b>3285</b>	<b>3333</b>
---------------	-------------------	----------------	------------------	-------------	-------------	-------------

### Night Stand



- One utility and two storage drawers
- Transitional style pulls
- Recessed back panel allows space for receptacles when unit sets flush against wall

Freight Class: 100

<b>PNST_B2F</b>	26.5" x 23.25" x 32"	Cubic Ft: 11.4	Ship Weight: 122	<b>1027</b>	<b>1042</b>	<b>1058</b>
-----------------	----------------------	----------------	------------------	-------------	-------------	-------------

## FINISH SELECTION

NATURAL MAPLE **FM** | ASPEN **AP** | PEARWOOD **PW** |  
WINDSOR CHERRY **WC** | MAHOGANY **M** | MEDIUM OAK **O** |  
ESPRESSO **X** | CLASSIC CHERRY **CC** | BLACK **E** | GREY **G** |

SIN 71-204 **PRAXIS**

HEALTHCARE

### Overhead Storage Hutch



Freight Class: 100

- One storage shelf
- Decorative valance under shelf
- Wire management grommet in back panel

		Zone Pricing	1	2	3
<b>PNSOVHD</b>	25.75" x 11.5" x 27" Cubic Ft: 4.6 Ship Weight: 38		<b>685</b>	<b>695</b>	<b>706</b>
	<b>Task Light T</b>		\$124	\$126	\$128
	<b>LED Task Light L</b>		\$212	\$215	\$218

## Praxis Dorm & Quarters

### Underbed Storage Cabinet/Drawer

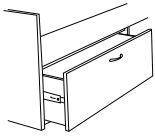

Freight Class: 100

- Thermally fused laminate case and drawer front
- Heavy-duty drawer slides
- Cabinet slides easily under Platform/Captains Bed
- Use P\_\_UBSTOR with P\_3680 bed
- Use P\_\_38UBSTOR with P\_3880 bed
- Can be used freestanding
- When ordering with Praxis Home items change pull indicator to PT\_ for transitional pulls

<b>P__UBSTOR</b>	36" x 19" x 13" Cubic Ft: 7.5 Ship Weight: 85		<b>651</b>	<b>661</b>	<b>671</b>
<b>P__38UBSTOR</b>	36" x 20" x 13" Cubic Ft: 7.8 Ship Weight: 94		<b>687</b>	<b>697</b>	<b>708</b>
<b>Pulls:</b>	BRUSHED CHROME <b>PW</b>	EBONY <b>PE</b>	BRIGHT BRASS <b>PB</b>	OVAL NICKEL <b>PD</b>	

### Dorm Platform/Captains Bed

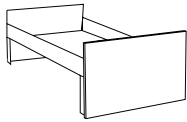

Freight Class: 125

- Platform bed frame
- P\_3880 accepts twin-size 38" x 80" mattress
- P\_3680 accepts single-size 36" x 80" mattress
- Open base design accepts up to 4 under-bed storage drawers (2 per side)
- Ships fully assembled

<b>P__3680</b>	82" x 39" x 24" Cubic Ft: 54.8 Ship Weight: 191		<b>943</b>	<b>957</b>	<b>971</b>
<b>P__3880</b>	82" x 41" x 24" Cubic Ft: 58.4 Ship Weight: 225		<b>996</b>	<b>1011</b>	<b>1026</b>

### Overhead Storage Bridge

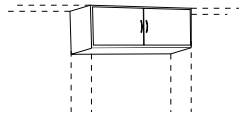

Freight Class: 125

- Two storage compartments behind doors
- Connects two wall cabinets at tops of cabinets
- Includes hardware for connecting to wall cabinets
- When ordering with Praxis Home items change pull indicator to PT for transitional style pulls
- Use P\_\_72M40SB with P\_3680 bed
- Use P\_\_72M42SB with P\_3880 bed

<b>P__72M40SB</b>	40" x 20" x 14.5" Cubic Ft: 12.7 Ship Weight: 75		<b>656</b>	<b>665</b>	<b>675</b>
<b>P__72M42SB</b>	42" x 20" x 14.5" Cubic Ft: 12.7 Ship Weight: 77		<b>692</b>	<b>702</b>	<b>713</b>
<b>Pulls:</b>	BRUSHED CHROME <b>PW</b>	EBONY <b>PE</b>	BRIGHT BRASS <b>PB</b>	OVAL NICKEL <b>PD</b>	

### Night Stand



Freight Class: 100

- One utility storage drawer
- One box storage drawer
- Open storage in base
- Adjustable leveling glides

<b>PNS_3</b>	23.5" x 20" x 29" Cubic Ft: 10.3 Ship Weight: 105		<b>831</b>	<b>843</b>	<b>856</b>
<b>Pulls:</b>	BRUSHED CHROME <b>PW</b>	EBONY <b>PE</b>	BRIGHT BRASS <b>PB</b>	OVAL NICKEL <b>PD</b>	

### Night Stand, One Drawer, One Door



Freight Class: 100

- One box storage drawer
- Storage in bottom behind door
- 4 Twin-wheel casters, 2 locking

<b>PNS__2C</b>	23.5" x 20" x 28.5" Cubic Ft: 10.3 Ship Weight: 100		<b>840</b>	<b>853</b>	<b>865</b>
<b>Pulls:</b>	BRUSHED CHROME <b>PW</b>	EBONY <b>PE</b>	BRIGHT BRASS <b>PB</b>	OVAL NICKEL <b>PD</b>	

## Desks

### Zone Pricing

1

2

3

### Left 3/4 Pedestal Desk



- Box/file pedestal on left
- Pre-installed filing hardware for letter or legal filing

Freight Class: 125

**P\_\_4222L** 42" x 22" x 29" Cubic Ft: 22 Ship Weight: 146 **887** **900** **914**

**Pulls:** BRUSHED CHROME **PW** EBONY **PE** BRIGHT BRASS **PB** OVAL NICKEL **PD**

### Right 3/4 Pedestal Desk



- Box/file pedestal on right
- Pre-installed filing hardware for letter or legal filing

Freight Class: 125

**P\_\_4222R** 42" x 22" x 29" Cubic Ft: 22 Ship Weight: 146 **887** **900** **914**

**Pulls:** BRUSHED CHROME **PW** EBONY **PE** BRIGHT BRASS **PB** OVAL NICKEL **PD**

### Left Full Pedestal Desk



- Box/box/file pedestal on left
- Pre-installed filing hardware for letter or legal filing

Freight Class: 125

**P\_\_4222L2BF** 42" x 22" x 29" Cubic Ft: 22 Ship Weight: 151 **970** **985** **999**

**Pulls:** BRUSHED CHROME **PW** EBONY **PE** BRIGHT BRASS **PB** OVAL NICKEL **PD**

### Right Full Pedestal Desk



- Box/box/file pedestal on right
- Pre-installed filing hardware for letter or legal filing

Freight Class: 125

**P\_\_4222R2BF** 42" x 22" x 29" Cubic Ft: 22 Ship Weight: 151 **970** **985** **999**

**Pulls:** BRUSHED CHROME **PW** EBONY **PE** BRIGHT BRASS **PB** OVAL NICKEL **PD**

## Overhead Storage

### Overhead Storage, Single Open Shelf



- Overhead storage with one open shelf
- Fits 42" desk

Freight Class: 125

**PW\_417** 42" x 10" x 24" Cubic Ft: 11.1 Ship Weight: 53 **514** **522** **529**

### Overhead Storage, Double Open Shelf



- Two open storage compartments
- Fits 42" desk

Freight Class: 125

**PW\_427** 42" x 10" x 37.75" Cubic Ft: 19 Ship Weight: 92 **547** **555** **563**

### Overhead Storage, Double Shelf with Doors



- Overhead storage with one open shelf
- Two storage compartments behind doors
- Fits 42" desks

Freight Class: 125

**P\_\_4272D** 42" x 10" x 37.75" Cubic Ft: 19 Ship Weight: 104 **725** **736** **747**

**Pulls:** BRUSHED CHROME **PW** EBONY **PE** BRIGHT BRASS **PB** OVAL NICKEL **PD**

# FEDERAL EXPRESS GROUND

## ITEMS BELOW CAN BE SHIPPED VIA FEDERAL EXPRESS GROUND SERVICE:

### Casegood Accessories

MODEL	DESCRIPTION
TL2P	Task Light
HW_CO	Compact Organizer
93757_	Coat Rack
MDCPU	CPU Holder
MDE	Power Strip
MDWM	Wire Management Channel
MD100-MD1014	Accessories for Accessory Wall
MDSHELF18-36	Shelf for Accessory Wall
PNP	Plug-N-Play
H26	Seat Cushion for Under Surface Storage

### Center Drawers

MODEL	DESCRIPTION
CD_18,19,30,32	Center Drawer
CVC66CTRS	Center Drawer
CVC66CTRD	Center Drawer
CVC72CTRS	Center Drawer
CVC72CTRD	Center Drawer
GVCD25_	Center Drawer
GVCD30_	Center Drawer
GVCD32_	Center Drawer
GVCD38_	Center Drawer
HWCD_19,25,32,38	Center Drawer
LVM32	Center Drawer
TR_29/30/32	Center Drawer
V_22,24,28,29/32/34/38	Center Drawer
WY_18,19,32,38	Center Drawer

### Occasional Tables

MODEL	DESCRIPTION
TR_4023	End Table
VT_100	End Table
VT_110	Coffee Table
HW_ET23	End Table
6723	End Table
T1005	Connecting Table

### Keyboard Trays

MODEL	DESCRIPTION
PKP25_	Keyboard Platform
PKP35_	Keyboard Platform
PKMP36_	Keyboard Platform
AKT008	Articulating Keyboard Tray (any mechanism)
AKT007	Articulating Keyboard Tray (any mechanism)
CV_K21	Keyboard Platform
HW_K21	Keyboard Platform
HW_K25	Keyboard Platform
HW_K29	Keyboard Platform
LVMK21	Keyboard Platform
LVMK35	Keyboard Platform
TR_3096	Keyboard Platform
GVK21	Keyboard Platform
GVK29	Keyboard Platform

### Office Seating

MODEL	DESCRIPTION
320 or 321 (Not Assembled)	Task Chair
330 or 331 (Not Assembled)	Task Chair
407 (Not Assembled)	Task Chair
500 (Not Assembled)	Task Chair
580	Task Chair
580CB	Task Chair
581	Task Chair
581CB	Task Chair
582	Task Chair
751 (Not Assembled)	Executive Swivel
752 (Not Assembled)	Management Swivel
759 (Not Assembled)	Guest Chair
2013	Guest Chair
2016	Conference Chair
1093	Arm Chair
723 or 724 (Up to three cartons of four)	Stax Chair

### Reception/Team Seating

MODEL	DESCRIPTION
UP9600SC	Replacement Seat Cushion
UP9600BC	Replacement Back Cushion
CH	Cup Holder
DH	Document Holder for Team Chair
NH	Newspaper Holder for Team Chair



# **SEATING UPHOLSTERIES AND TECHNICAL SPECIFICATIONS**





## GRADE 1

### Perk

970	Walnut
971	Crimson
972	Sesame
973	Flint
974	Cedar
975	Dijon
976	Patriot
977	Auburn

### Core

950	Eve
951	Dune
952	Macro
953	Shale
954	Vital

### Expo

960	Sky
961	Sprout
962	Leaf
963	Latte
964	Festive
965	Fog
966	Lemon
967	Viola
968	Tuxedo
969	Raspberry

### Quattro

300-000	Honeycomb
300-001	Deep Crimson
300-002	Wheat
300-003	Spring Green
300-004	Midnight Blue
300-005	Dark Orchid
300-006	Granite
300-007	Chalk
300-009	Umber
300-011	Hibiscus
300-013	Olive
300-014	Skyway
300-019	Golden Orange
300-024	Laguna
300-026	Mercury

### Forte'

298-000	Fudge
298-001	Rouge
298-003	Chive
298-004	Cadet
298-006	Tuxedo
298-007	Sable
298-009	Pimento
298-011	Port
298-013	Avocado
298-016	Slate
298-017	Pumice
298-019	Squash
298-026	Flint
298-033	Fairway
298-036	Char

### Crosscheck

299-000	Otter
299-003	Lime
299-005	Wisteria
299-006	Slate Black
299-007	Saddle Tan
299-011	Vermillion
299-014	Imperial
299-019	Demerera
299-021	Red Baron
299-023	Aquamarine
299-024	Blue Ribbon
299-026	Platinum

### Squirm

0604	Navy
4242	Terracotta
8704	Meadow
9729	Linden

### Prism

741	Brick
742	Ocean
743	Green
744	Slate
745	Pebble

### Royalty

751	Gold
752	Merlot
753	Bouquet
755	Green
757	Pewter

### Sway

0621	Silver Fish
4262	Red River
5506	Sand Dollar
7747	Green Grass
8454	Blue Sea

### Jamestown Vinyl

357	Green
358	Black
360	Antique Blue
361	Oxblood
362	Walnut
365	Dark Blue

### Woodford (Cortz) Faux Leather

WO-540	Burgundy
WO-542	Charcoal
WO-543	Blueberry
WO-544	Hunter Green
WO-545	Black

## GRADE 2

### Foundation 10 Recycled Polyester

350-000	Chocolate
350-001	Wine
350-002	Corn silk

350-003	Sherwood
350-004	Sapphire
350-005	Concord
350-006	Ebony
350-007	Sandstone
350-008	Merlot
350-009	Cayenne
350-010	Taupe
350-011	Flame
350-012	Sunflower
350-013	Hunter
350-014	Navy
350-016	Mercury
350-017	Jodhpurs
350-018	Magenta
350-019	Terra Cotta
350-020	Bark
350-023	Apple Green
350-024	Blue Mist
350-026	Graphite
350-027	Buckskin
350-028	Purple Haze
350-031	Rouge
350-033	Cactus
350-034	Parade Blue
350-043	Peacock
350-044	Capri
350-053	Aegean
350-054	Cyan
350-064	Ocean
350-074	Turquoise
350-093	Basil

### Bliss

450	Gobi Beige
451	Red Pepper
452	Greentree
453	Stonework
454	Confederate Blue

### Rhumba

460	Ink Blue
461	Red Rover
462	Gold Bullion
463	Slate
464	Texas Tea

### Sketch

812	Carbon
813	Cardinal
814	Denim
815	Hunter

### Kinetic

808	Black Gold
809	Blue
810	Dark Green
811	Ruby

### Precision

498	Black
3175	Beige
3204	Navy
8414	Blue
8477	Green

### Whirl

1709	Corn silk
04242	Tomato
6777	Pesto
8404	Cadet

### Pivot

679	Garnet
690	Lagoon
701	Mesa
723	Pesto
734	Tower

### Carrara Vinyl

CR500	Black
CR501	Steel Blue
CR503	Forest Green
CR508	Burgundy
CR509	Tan
CR510	Buck

## GRADE 3

### Legacy Faux Leather

LY600	White
LY608	Medium Beige
LY609	Chocolate
LY614	Brite Red
LY616	Royal
LY617	Deep Purple
LY618	Pale Green
LY620	Deep Blue
LY625	Black

### Macallan Recycled Leather

MAC431	Doe
MAC434	Parchment
MAC436	Saddle
MAC437	Dark Brown
MAC440	Burgundy
MAC442	Charcoal
MAC443	Blueberry
MAC444	Hunter Green
MAC445	Black

### Pavers Crypton

09	Black Gold
31	Blue Water
35	Brick

### Soothe Crypton

03	Gold
06	Red
16	Navy

### Figure Eight

326-000	Stormy Weather
326-001	Pomegranate
326-002	Marigold
326-003	Feldspar
326-004	Azure
326-006	Ebony
326-007	Buff

**QS** Indicates a Quick Ship item

ALL FOAM & FABRICS USED ARE CAL 117 APPROVED

## Marquise

325-000	Smoky Quartz
325-001	Ruby
325-002	Citrine
325-003	Peridot
325-004	Aquamarine
325-006	Onyx
325-007	Pearl

## Mosaic

349-000	Espresso
349-001	Blaze
349-002	Caramel
349-003	Laurel
349-004	Cerulean
349-007	Natural
349-009	Mango
349-010	Taupe
349-013	Spring
349-014	Dusk

## Destiny

360-001	Fiesta
360-003	Meadow
360-004	Sapphire
360-006	Granite
360-007	Beachcomber
360-009	Pumpkin
360-013	Celadon
360-014	Capri
360-019	Bronze
360-024	Azure

## GRADE 4

### Phoenix Faux Leather

PH-000	Fudge
PH-001	Berry
PH-002	Wheat
PH-003	Palm
PH-004	Admiral
PH-006	Lava
PH-007	Natural
PH-008	Magenta
PH-010	Mocha
PH-012	Cream
PH-013	Jungle
PH-014	Navy
PH-017	Buckskin
PH-019	Chili
PH-020	Clove
PH-022	Butterscotch
PH-024	Cobalt
PH-026	Charcoal
PH-027	Saddle
PH-029	Marigold
PH-032	Straw
PH-039	Tangelo
PH-044	Sky
PH-046	Chalk

### Emu Faux Leather

EU-000	Espresso
EU-002	Caramel
EU-003	Forest
EU-004	Ultramarine
EU-006	Black
EU-007	Oyster
EU-009	Tawny
EU-010	Patina
EU-013	Eucalyptus
EU-016	Meteor
EU-020	Bark
EU-023	Pistachio
EU-026	Pebble
EU-030	Latte

### Flower Power Recycled Polyester

374-001	Crimson
374-002	Gold
374-003	Jade
374-004	Periwinkle
374-006	Shadow
374-007	Taupe
374-014	Sapphire
374-017	Ecru

### Shantung Recycled Polyester

373-000	Bark
373-001	Garnet
373-002	Topaz
373-003	Jade
373-005	Hibiscus
373-006	Shadow
373-007	Parchment
373-009	Copper
373-014	Cerulean
373-017	Alabaster
373-024	Mist
373-034	Marine

### Caressa Faux Leather

CA-001	Ruby
CA-002	Butterscotch
CA-004	Navy
CA-005	Aubergine
CA-006	Black
CA-007	Kilimanjaro
CA-010	Chocolate
CA-012	Mojave
CA-016	Pewter
CA-027	Buff
CA-029	Ochre
CA-030	Taupe
CA-037	Papyrus
CA-041	Burgundy
CA-044	Cadet
CA-047	Doe
CA-050	Saddle
CA-053	Laurel
CA-063	Willow
CA-064	Cerulean
CA-073	Basil

CA-074	Spa
CA-084	Aqua
CA-093	Bluegrass

### Laredo Vinyl

L04	Tan
L06	Taupe
L08	Chocolate
L09	Copen
L11	Mosstone
L12	Pumice
L13	Cinnabar
L14	Meritage
L18	Onyx
L21	Quarry
L26	Blue Moon
L33	Grape

## GRADE 5

### Thicket

6365	Black Tea
6368	Chutney
6369	Quicksilver
6371	Blueprint
6372	Sour Cherry
6373	Chestnut
6374	Pansy

### Dakota Faux Leather

DKT21	Tree Bark
DKT27	Dune
DKT28	Cedar
DKT29	Shiraz
DKT32	Caribou
DKT33	Lacquer
DKT34	Nutmeg
DKT36	Desert
DKT37	Flint
DKT38	Fudge
DKT39	Hyacinth
DKT40	Onyx

### Twister Recycled Polyester

347-000	Basalt
347-001	Poppy
347-002	Chamois
347-003	Green Tea
347-004	Cobalt
347-007	Parchment
347-011	Claret
347-013	Aegean
347-014	Cerulean

### Tiles Vinyl

TI-001	Claret
TI-002	Aztec
TI-003	Basil
TI-004	Indigo
TI-006	Raven
TI-009	Persimmon
TI-012	Goldstone

TI-013	Willow
TI-014	Aquamarine
TI-016	Pewter
TI-019	Amberglow
TI-033	Ripe Olive

### Guardian Healthcare Vinyl

GU-000	Umber
GU-001	Scarlet
GU-002	Chamois
GU-003	Jade
GU-004	Indigo
GU-005	Purple
GU-006	Ebony
GU-007	Doeskin
GU-008	Port
GU-009	Terra Cotta
GU-010	Greige
GU-011	Paprika
GU-013	Willow
GU-014	Regatta
GU-016	Charcoal
GU-017	Parchment
GU-023	Green Tea
GU-024	Cyan
GU-026	Shadow
GU-033	Citron
GU-034	Spa
GU-043	Pampas
GU-044	Turquoise
GU-053	Bronze

### Silverweave Healthcare Vinyl

SW-000	Cocoa
SW-001	Cranberry
SW-002	Sienna
SW-003	Jade
SW-004	Indigo
SW-005	Eggplant
SW-006	Graphite
SW-007	Camel
SW-009	Cayenne
SW-010	Walnut
SW-013	Willow
SW-014	Baltic
SW-016	Cadet
SW-017	Doe
SW-019	Tangerine
SW-020	Mica
SW-023	Moss
SW-024	Cobalt
SW-027	Ivory
SW-029	Amber
SW-033	Lichen
SW-034	Cyan
SW-037	Alabaster
SW-044	Calypso

## GRADE 6

### Rain Dance Woven Crypton

WC956-003 ..... Aloe  
 WC956-004 ..... Lake  
 WC956-005 ..... Aubergine  
 WC956-006 ..... Sterling  
 WC956-008 ..... Magenta  
 WC956-009 ..... Flame  
 WC956-013 ..... Black Olive  
 WC956-014 ..... Zenith

### Habitat Woven Crypton

WC958-000 ..... Shadow  
 WC958-001 ..... Russet  
 WC958-002 ..... Sunshine  
 WC958-003 ..... Herb  
 WC958-004 ..... Indigo  
 WC958-007 ..... Ecu  
 WC958-008 ..... Magenta  
 WC958-014 ..... Zenith  
 WC958-017 ..... Taupe

### Jitterbug Woven Crypton

WC953-001 ..... Mars  
 WC953-002 ..... Topaz  
 WC953-003 ..... Oregano  
 WC953-004 ..... Prism  
 WC953-005 ..... Pansy  
 WC953-006 ..... Driftwood  
 WC953-007 ..... Parchment  
 WC953-009 ..... Cayenne  
 WC953-014 ..... Delta

### Fizz Vinyl

FIZ21 ..... Orange Soda  
 FIZ22 ..... Sarsaparilla  
 FIZ23 ..... Spritzer  
 FIZ24 ..... Champagne  
 FIZ25 ..... Tonic  
 FIZ26 ..... Effervesce  
 FIZ27 ..... Bubbly  
 FIZ28 ..... Cream Soda  
 FIZ29 ..... Lemon Lime

### Echo

010 ..... Limestone  
 030 ..... Lichen  
 032 ..... Oxide  
 040 ..... Cedar  
 041 ..... Cabochon  
 042 ..... Peppercorn  
 050 ..... Henna  
 080 ..... Seaport  
 090 ..... Russet

### Rock Star

4010 ..... Steel Blue  
 4011 ..... Poolside  
 4020 ..... Frost  
 4030 ..... Limelight  
 4040 ..... Sepia

4110 ..... Cappuccino  
 4112 ..... Dark Matter  
 4130 ..... Fern  
 4140 ..... Paprika

## GRADE 7

### Tracing Recycled Polyester

6624 ..... Sandstone  
 6625 ..... Honey  
 6626 ..... Sage  
 6627 ..... Bermuda  
 6628 ..... Autumn  
 6630 ..... Holiday  
 6631 ..... Yacht Blue  
 6632 ..... Amazon  
 6633 ..... Obsidian

### Arc Recycled Polyester

6565 ..... Rainforest  
 6566 ..... Henna  
 6567 ..... Paprika  
 6568 ..... Rattan  
 6569 ..... Lagoon  
 6570 ..... Chianti  
 6571 ..... Marsh  
 6572 ..... Pacific  
 6573 ..... Obsidian

### Script

884-000 ..... Earth  
 884-001 ..... Sangria  
 884-002 ..... Maize  
 884-003 ..... Feldspar  
 884-004 ..... Cyan  
 884-006 ..... Ebony  
 884-007 ..... Glacier  
 884-009 ..... Mango Tango  
 884-017 ..... Tropic Vanilla

### Freehand Recycled Polyester

6582 ..... Midnight  
 6583 ..... Shiraz  
 6584 ..... Neutral  
 6585 ..... Field  
 6586 ..... Eggplant  
 6587 ..... Dune  
 6588 ..... Madrona  
 6589 ..... Bark

## GRADE 8

### On the Money Woven Crypton

62086 ..... Mesquite  
 62087 ..... Rain  
 62088 ..... Biscotti  
 62089 ..... Belair  
 62090 ..... Carmine

62091 ..... Paprika  
 62092 ..... Oregano  
 62093 ..... Swift

### Vibe Woven Crypton

61606 ..... Gingersnap  
 61607 ..... Earth  
 61608 ..... Twilight  
 61610 ..... Caramel  
 61611 ..... Pine  
 61612 ..... Indigo  
 61613 ..... Sour Cherry

### Marvel Recycled Polyester

342-000 ..... Sable  
 342-001 ..... Flame  
 342-002 ..... Topaz  
 342-003 ..... Basil  
 342-004 ..... Cobalt  
 342-006 ..... Graphite  
 342-007 ..... Natural  
 342-009 ..... Tigerlillie  
 342-010 ..... Cliff  
 342-013 ..... Wasabi  
 342-014 ..... Cyan  
 342-024 ..... Aqua

### Ottoman

LC870-000 ..... Sable  
 LC870-002 ..... Ochre  
 LC870-003 ..... Jade  
 LC870-004 ..... Azure  
 LC870-006 ..... Ebony  
 LC870-007 ..... Ivory  
 LC870-009 ..... Copper

### Glimmer Polyurethane

GL-000 ..... Java  
 GL-001 ..... Tabasco  
 GL-002 ..... Daffodil  
 GL-003 ..... Ivy  
 GL-004 ..... Caribbean  
 GL-005 ..... Violet  
 GL-006 ..... Graphite  
 GL-007 ..... Almond  
 GL-009 ..... Copper  
 GL-011 ..... Ruby  
 GL-013 ..... Surf  
 GL-017 ..... Porcelain

### Charade Recycled Polyester

355-000 ..... Flax  
 355-001 ..... Vermillion  
 355-003 ..... Forest  
 355-004 ..... Cerulean  
 355-006 ..... Stone  
 355-007 ..... Raffia  
 355-009 ..... Mango  
 355-014 ..... Opal  
 355-019 ..... Rust

## GRADE 9

### Tangled Web

LC887-000 ..... Sable  
 LC887-001 ..... Claret  
 LC887-003 ..... Olive  
 LC887-004 ..... Azure  
 LC887-006 ..... Pewter  
 LC887-007 ..... Alabaster  
 LC887-009 ..... Copper  
 LC887-013 ..... Celadon  
 LC887-014 ..... Ice Blue

### Bungalow Solution-Dyed Nylon

362-000 ..... Shiitake  
 362-001 ..... Rouge  
 362-003 ..... Opal  
 362-004 ..... Bluestone  
 362-005 ..... Lavender  
 362-006 ..... Granite  
 362-007 ..... Ecu  
 362-009 ..... Curry  
 362-014 ..... Blue Nile

### Ascension

888-001 ..... Rouge  
 888-002 ..... Lemon Drop  
 888-003 ..... Celadon  
 888-004 ..... Cerulean  
 888-006 ..... Ebony  
 888-007 ..... Stone  
 888-009 ..... Spice  
 888-013 ..... Limelight  
 888-014 ..... Eucalyptus

### Synapse

891-000 ..... Sandstone  
 891-003 ..... Wasabi  
 891-004 ..... Indigo  
 891-006 ..... Obsidian  
 891-007 ..... Alabaster  
 891-008 ..... Malbec  
 891-009 ..... Spice

### Silica

- Quartz
- Terra
- Ginger
- Cumulus
- Nero
- Alloy
- Burnished
- Haze
- Skyward
- Gallant
- Appletini
- Brownstone
- Bistro
- Marigold
- Dewpoint
- Glade
- Medal
- Herbal
- Garnet
- Tropic
- Coppercrest

### GRADE 10

#### Erode Solution-Dyed Nylon

- 364-000 ..... Shiitake
- 364-001 ..... Chianti
- 364-003 ..... Limelight
- 364-004 ..... Cerulean
- 364-005 ..... Boysenberry
- 364-006 ..... Stone
- 364-007 ..... Honeycomb
- 364-009 ..... Sunkissed
- 364-014 ..... Eucalyptus

#### Jumpin' Jacks

- LC850-001 ..... Crimson
- LC850-003 ..... Spruce
- LC850-004 ..... Cobalt
- LC850-006 ..... Mocha
- LC850-007 ..... Raffia
- LC850-009 ..... Dreamsicle
- LC850-013 ..... Chartreuse
- LC850-014 ..... Bluemist
- LC850-023 ..... Aquamarine

### Sumatran Palm Woven Crypton

- 62296 ..... Grain
- 62297 ..... Fresco
- 62298 ..... Cantaloupe
- 62299 ..... Lime
- 62300 ..... Clematis
- 62301 ..... Hawk
- 62302 ..... Firefly
- 62303 ..... Cobalt

### Jambi Stripe Woven Crypton

- 62315 ..... Beach
- 62316 ..... Summer Day
- 62317 ..... Aegean
- 62318 ..... Island
- 62319 ..... Sun Porch
- 62320 ..... Ember
- 62321 ..... Carnival
- 62322 ..... Bonfire
- 62323 ..... Ocean
- 62324 ..... Toffee

### Juxy Vinyl

- JUX02 ..... Radius
- JUX03 ..... Rhyolite
- JUX04 ..... Pulsar
- JUX05 ..... Photon
- JUX06 ..... Sunspot
- JUX07 ..... Ariel
- JUX08 ..... Vela
- JUX09 ..... Basalt
- JUX10 ..... Parallax
- JUX11 ..... Burst
- JUX12 ..... Ultraviolet
- JUX13 ..... Spectra

### Martini Vinyl

- MAR02 ..... Citrus
- MAR06 ..... Carob
- MAR07 ..... Marine
- MAR08 ..... Gull
- MAR09 ..... Turmeric
- MAR10 ..... Haze
- MAR12 ..... Shore

## UPHOLSTERY LIST PRICING

*For fabric-only purchases*

	ZONE 1	ZONE 2	ZONE 3
GRADE 1	<b>\$36</b>	<b>\$36</b>	<b>\$36</b>
GRADE 2	<b>\$66</b>	<b>\$66</b>	<b>\$66</b>
GRADE 3	<b>\$89</b>	<b>\$89</b>	<b>\$89</b>
GRADE 4	<b>\$112</b>	<b>\$112</b>	<b>\$112</b>
GRADE 5	<b>\$133</b>	<b>\$133</b>	<b>\$133</b>
GRADE 6	<b>\$161</b>	<b>\$161</b>	<b>\$161</b>
GRADE 7	<b>\$189</b>	<b>\$189</b>	<b>\$189</b>
GRADE 8	<b>\$217</b>	<b>\$217</b>	<b>\$217</b>
GRADE 9	<b>\$245</b>	<b>\$245</b>	<b>\$245</b>
GRADE 10	<b>\$280</b>	<b>\$280</b>	<b>\$280</b>
L	<b>\$25</b>	<b>\$25</b>	<b>\$25</b>
LL	<b>\$35</b>	<b>\$35</b>	<b>\$35</b>

*Fabrics priced per yard. Leather priced per square foot.*



- Available on all HPFI Seating
- All available at HPFI industry-leading standard lead times
- All meet CAL 117

**Real.** When you specify **leather furnishings from HPFI, each piece is 100% leather.** And all are real, top-grain leathers. No synthetics. No substitutes. Just real leather selected for quality and characteristics that create unique furnishings.

**Natural.** Leather is a **natural material.** It is an environmentally conscious upholstery cover salvaged as a by-product from meat production processes. Incorporating leather into multiple products – from furniture to clothes – is consistent with “green” efforts to improve production’s impact on our environment.

**Leather.** Leather is **UNIQUE.** Each hide features characteristics developed in nature, distinguishing it from any other hide. Even within a leather hide, variations in color, texture and markings (scars, scratches, wrinkles, etc.) are natural and will appear within a given upholstered piece of furniture. These variations are not imperfections, rather they are the very essence of what makes leather an exquisite and preferred upholstery material.

**LEATHER ADVANTAGES.** History and tradition of use generate a special affinity and emotional preference for leather. Also consider:

- Leather breathes. It can absorb up to 25% of its own weight in humidity and release that humidity, so the body does not perspire on leather as it does on vinyl.

- Leather adapts to the closest temperature. An untouched leather chair remains room temperature. Once you sit down, the leather reaches body temperature, no higher!
- Leather is less permeable than fabrics. This barrier feature protects internal chair components from spills, inhibits dust collection by a chair’s cushioning material and provides easily cleanable surfaces.

**Top Grain.** All are **top-grain leather taken from the outermost layer of the hide, providing the strongest,** softest and most breathable leather from the hide. Additionally, top grains show the natural markings (wrinkles, scratches, scars, etc.) that make each leather unique.

#### THE LANGUAGE OF LEATHER

Leather hides are processed in many different fashions, creating a variety of appearances, tactile qualities and performance capabilities. These processes and the resulting characteristics create a leather language used to classify leathers as outlined below.

**Full vs. Corrected Grain.** Full grain leathers exhibit more of the natural variation, texture and markings of the animal. These leathers are generally softer than corrected leathers. Corrected grain leathers have been mechanically altered through buffing, sanding or embossing to create more consistent grain pattern and uniform appearance.

**Semi-Aniline.** Starting with the same base as full anilines, the semi-aniline is a soft leather featuring a transparent finish that improves light and stain resistance. Slight pigmentation may be added to minimize color variation within the hide.

**Pigmented.** These leathers feature pigment dye applied by machine spray or roller coating, then followed by a finish coat to seal the pigment. Pigment/sealer increases a leather’s resistance to fading and wearing while decreasing the softness of the material. Pigmented leathers are easier to clean and care for than non-pigmented leathers.

**Pullup.** Pullup leathers derive their color from waxes or oils, which dissipate and become lighter in color when the leather is pulled, as done during the upholstery process. This creates worn, weathered, distressed appearance typically found only on furnishings subjected to years of use.

**Hand Antiqued.** As the name implies, these leathers are handcrafted using traditional leather techniques.

**Sauvage.** Subtle, abstract two-tone finishes on leather provide visual depth and interest to a leather and are known as Sauvage.

HPFI can work with our leather supplier partners to color match an existing leather installation. There is a minimum of 500 square feet. Lead time to color match will take 5 - 6 weeks.

**Note:** HPFI leather seating employs multi-piece backs and sides to improve yield of natural leather hides.

## GRADE L

### Baroque

- AL03 ..... Black
- AL04 ..... **QS** Blackberry
- AL05 ..... Midnight
- AL06 ..... **QS** Hunter
- AL07 ..... Spruce

### Crackle

- AL12 ..... Chianti
- AL13 ..... Coffee
- AL14 ..... Walnut

## Mammut (Formerly Bronco)

- AL18 ..... **QS** Black
- AL15 ..... Parchment
- AL20 ..... Burgundy
- AL16 ..... Hunter Green
- AL19 ..... Navy
- AL17 ..... Fawn
- AL22 ..... Tan
- AL23 ..... Espresso

## GRADE LL

### Kingsland

- AL21 ..... Coffee
- AL24 ..... Navy
- AL27 ..... Chaps
- AL29 ..... Jalapeno

### FOC Earth

- 560001 ..... Black
- 560007 ..... Tobacco
- 560029 ..... Parchment
- 560032 ..... Chocolate
- 560035 ..... Fawn

## Lena

- 2500 ..... Pewter
- 3338 ..... Navy
- 3364 ..... Sequoia
- 3368 ..... Chateau
- 3396 ..... Linen
- 5454 ..... Celtic
- 8000 ..... White
- 9000 ..... Black

Hide	Number of Colors	100% Top Grain	Full Grain	Semi-Aniline	Pigmented	Machine Spray	Savage	Chrome-Free
Baroque	5	•		•	•	•	•	
Crackle	3	•		•	•	•	•	
Mammut (Bronco)	8	•		•	•	•		•
Kingsland	4	•		•	•	•	•	
FOC Earth	31	•		•	•	•		•
Lena	48	•	•	•	•	•		

*Due to the natural characteristics of leather, finished furnishings may vary from original swatches. HPFI neither guarantees nor warrants leather for color, color consistency, grain or other characteristics. We cannot accept return of leather furnishings for such issues.*

## Care & Cleaning

Leather specialists at Leather Master can provide you with specially-developed leather care and cleaning agents.

Call **888-825-6551**.





**HPFI & Mayer Fabrics' Alliance Program** offers fine furniture in thousands of fabric, vinyl, faux leather and Crypton upholstery selections at standard lead time. Select your Mayer Fabric on a HPFI frame and refer to the pattern grades listed below for pricing.

**Free memo samples** are available and can be shipped directly from Mayer to you or your end user by calling **1-800-428-4415** and referencing the HPFI Alliance Program. To review the extensive selection of Mayer Fabrics, you can also visit [www.mayerfabrics.com](http://www.mayerfabrics.com).

## ALLIANCE PROGRAM:

### FABRICS

Abacus {R60+} 8	Ecosphere [Pre C.] 8	Kismet [Pre C.] 8	Revival 5
Acanthus 6	Element (A) [Pre C.] 4	Locomotion 6	Ritz 6
Agora 7	Equation [Pre C.] 6	Lunar [Pre C.] 5	Scrimmage Line 7
Alcazar 5	Equinox (AF) 5	Luxor 10	<b>Script (FR) 7</b>
Amulet 3	<b>Erode 10</b>	Madras 6	Segment 7
Amulet (DuraBlock™) 5	Esprit [Pre C.] 6	<b>Marquise {R60+} 3</b>	Sequel 3
Arcade 7	Essential 3	Marrakesh 10	<b>Shantung 4</b>
<b>Ascension 9</b>	Europa [Pre C.] 6	<b>Marvel [Pre C.] 8</b>	Side by Side (10) 8
Astro 5	Facets 10	Maze {R60+} 7	Sojourn 3
Atlantis 10	Factor [Pre C.] 6	Metallurgy 10	Sojourn (DuraBlock™) 5
Axis 6	<b>Figure Eight [Pre C.] 3</b>	Mirage 7	Solid Ground 7
Bar None 8	Filigree [Pre C.] 6	Moonscape [Pre C.] 5	Source 3
Bella 8	Flourish 5	<b>Mosaic 3</b>	Source (DuraBlock™) 5
Benefit [Pre C.] 6	<b>Flower Power 4</b>	Mosaic (DuraBlock™) 5	Spacer Mesh 4
Bijou 5	Flying High {R60+} 5	Mum 3	Spotlight 9
Broadway 5	Formula FR 7	Mum (DuraBlock™) 5	Sprint (FR) 8
Brocade 5	<b>Forte 1</b>	Myriad [81% RPI, 19% RPC] 8	Straight & Narrow {R60+} 8
Bulls Eye [Pre C.] 6	Forum FR 7	Mystic [Pre C.] 6	Structure 4
<b>Bungalow 9</b>	<b>Foundation (10) [Post C.] 2</b>	Necktie Stripe 10	Sunset Strip 4
Burst [Post C.] 7	Framework [Post C.] 6	Nylon-Stat ESD 9	Symmetry (10) 7
Canvas 8	Genesis 3	October's Party 7	<b>Synapse 9</b>
Catalyst 5	Genesis (DuraBlock™) 5	Odyssey 7	Syncopation (10) 8
<b>Charade [Post C.] 8</b>	Glamour 7	Oracle 10	Taj 4
Clarity 4	Glee 5	Orbit 7	<b>Tangled Web 9</b>
Classic Velvet 6	Heritage 5	<b>Ottoman 8</b>	Techno Texture 10
Component 5	High Society 6	Over The Top {R60+} 6	Tendril 3
Connections FR 8	Hoopla 6	Paramount 5	Tendril (DuraBlock™) 5
Cornerstone 4	Icon (FR) 8	Pavilion 9	Tranquility 9
<b>Cross Check 1</b>	Illusion 10	Petit Point 8	<b>Twister [Post C.] 5</b>
Daydream 5	Impulse [Pre C.] 5	Pinnacle 5	Ultima 6
Deco Motion 10	In The Groove {R60+} 6	Pisces [Post C.] 6	Valor 3
<b>Destiny 3</b>	Insignia 10	Portal [Post C.] 7	Valor (DuraBlock™) 5
Destiny (DuraBlock™) 5	Jenga [Post C.] 7	Pulse 8	Venue [Pre C.] 6
Duraweave® (10) 3	Jubilee 4	<b>Quattro 1</b>	Vibrant 8
Eclipse 10	<b>Jumping Jacks 10</b>	Rapport 5	Virtually Suede 7
	Kaleidoscope (FR) 9	Regency 6	Wave Length 3
	Karma [Post C.] 9	Reiki [Post C.] 9	Zanzibar 8

### MAYER UPHOLSTERY LEGEND SYMBOLS

(\*) - Not appropriate for Health Care Applications

(FR) - Fire resistant

(R60+) - 60% or more recycled material

(Pre C) - 100% recycled post industrial

(Post C) - 100% recycled post consumer

 - 100% recycled Terratex®

(10) - 10 year warranty. See swatch card for details.

(N) - Nanocide™ is the newest technology for combating infections caused by transfer from upholstered furniture, athletic equipment, or other common sources of transfer from upholstered objects.

Please note, patterns in **bold type** are part of HPFI's standard fabric program. See pages 239-242 for color ways available.

**QS** Indicates a Quick Ship item

ALL FOAM & FABRICS USED ARE CAL 117 APPROVED

## ALLIANCE PROGRAM: (CONTINUED)

### FAUX LEATHER

Antique\*\* 6  
**Caressa FR 4**  
 Caressa Suede 5  
 Cayman 8  
 Cork 8  
 Durango 3  
**Emu 4**  
 Florentino 4  
 Gala 7  
**Glimmer 8**  
 Hombre 8  
 Jekyll & Hyde\*\* 5  
 Kobe 4  
 Komodo 4  
**Laredo 8**  
 Makore 8  
 Maverick 3  
 Melody 8  
 Milano 6  
 Outback 4  
 Patent 9  
**Phoenix 4**  
 Quark 10  
 Radiance 5  
 Santa Ana 5  
 Shimmer 9  
 Virtually 9

### VINYLS

All Seasons FR 4  
 All Use FR 4

Athens FR 6  
 Blocks 4  
 Chaps FR 6  
 Crystals 8  
 Curlicue 5  
 Currents 6  
 Dakota 6  
 Dublin Tweed FR 6  
 Gala (S) 6  
**Guardian 5**  
 Heather FR 6  
 Jamestown 3  
 Key Largo 4  
 Linen 4  
 Madrid SP Black 1  
 Microdot 5  
 Oxen SP Black 1  
 Peerless 6  
 Pinehurst 6  
 Prado 6  
 Punch 5  
 Sierra SP Black 1  
 Silk Screen 6  
**Silverweave 5**  
 Skate 8  
 Spirograph 8  
**Tiles 5**  
 Toss Up 6  
 Tributary 5  
 Tussah 6  
 Uptown 6  
 Ventura 4  
 Vinyl Stat ESD 8  
 Wallaby SP Black 1

Webscape 8  
 Willow 3

### WOVEN CRYPTON®

Acclaim 7  
 Accord 8  
 Aldine 8  
 Altemont 9  
 Amadeus 9  
 Arabesque 7  
 Aristocrat 7  
 Atelier 10  
 Barenthal 9  
 BeBop 8  
 Boulevard 9  
 Branch Out 8  
 Brio 9  
 Celtic 7  
 City Lights 8  
 Cribbage 7  
 Disco 7  
 Domain 8  
 Escapade {R60+} 10  
 Fable 8  
 Fathom 6  
 Finale 7  
 Finish Line 8  
 Gramercy Park 10  
 Gusto 10  
**Habitat 7**  
 Holiday 7  
**Jitterbug 6**

Journey 7  
 Leafage 9  
 Metro 6  
 Mirabella 8  
 Napoli 10  
 Nostalgia 7  
 On the Spot 10  
 Oxford {R60+} 9  
 Panache 10  
 Parkland 10  
 Pastime 7  
 Pathway 7  
 Posh 8  
 Primo 7  
 Promenade {R60+} 8  
**Rain Dance 6**  
 Razzmatazz 8  
 Realm [Pre C.] 10  
 Rebound [Pre C.] 8  
 Replay [Pre C.] 8  
 Round 'N Round 8  
 Smart Suede 7  
 Social Network 7  
 Soho 7  
 Solaris 10  
 Stanza [Pre C.] 8  
 Suede 7  
 Taffeta Stripe 7  
 Tea Leaves 7  
 Time Line 6  
 Toscana 10  
 Tracery 8



MAYERFABRICS

**CALL 800-428-4415**  
**FOR MEMO SAMPLES.**  
**WWW.MAYERFABRICS.COM**

### MAYER UPHOLSTERY LEGEND SYMBOLS

(\*) - Not appropriate for Health Care Applications  
 (FR) - Fire resistant  
 (R60+) - 60% or more recycled material  
 (RPI) - 100% recycled post industrial  
 (RPC) - 100% recycled post consumer  
 ♻️ - 100% recycled Terratex®

(10) - 10 year warranty. See swatch card for details.

(N) - Nanocide™ is the newest technology for combating infections caused by transfer from upholstered furniture, athletic equipment, or other common sources of transfer from upholstered objects.

Please note, patterns in **bold type** are part of HPFI's standard fabric program. See pages 239-242 for color ways available.

All HPFI seating products are available in Momentum Textiles, a popular and broad range of contract upholsteries. Patterns have been price graded and listed to simplify quoting/ordering as well as save time versus Customer's Own Material (COM) processes.

Momentum patterns not listed must be priced per project; contact Customer Service with HPFI models, quantities and selected Momentum patterns. Confirm standard lead time availability with Customer Service prior to order.

## More information on Momentum

Textiles is available at [www.memosamples.com](http://www.memosamples.com).

## MOMENTUM FABRICS & GRADES:

### FABRICS

A Cappella 6	Coalesce 9	Hi-Fi 6	Occasion 6
Acacia 10	Connect The Dots 6	Hint 6	Origin 3
Ace 3	Context 3	Hipster 6	Palmer 8
Adagio 6	Cool Beat 9	Homespun 7	Paradox 5
Aiken 8	<b>Core 1</b>	Hopscotch 6	Parallel 6
Alibi 8	Coy 7	Hue 4	Pause 7
A-List 6	Credo 6	Imagine 6	Pawn 6
Ambient 8	Crew 10	Impact 6	Peace 9
Amenity 10	Crush 7	Innove 8	Pearce 10
Amore 6	Delve 9	Insight 3	Pendant 6
Apex 9	Dive 9	Intermix 7	Perch 8
Arista 8	Divvy 6	Interval 3	<b>Perk 1</b>
Asana 9	Dolce 6	Invite 6	Petite 6
Aspire 6	Duo 10	Inyo 6	Pinnacle 7
Atmosphere 7	Ease 7	Jargon 3	Pinpoint 3
Axis 3	Element 9	Journey 6	Pirouette 6
Bandwidth 10	Elliott 8	Juxtapose 7	<b>Pivot 2</b>
Basis 3	Emerge 5	Kayo 3	Plume 9
Beckon 6	Enchant 6	Keepsake 6	Pluto 6
Bel Canto 6	Encounter 5	Keleko 5	Pogo 8
Block Party 10	Entwine 9	Kindle 9	Ponder 5
Boom 6	Epoch 7	Knack 4	Pop 5
Cachet 4	Essentia 9	La-Dee-Da 6	Portal 8
Calligraphy 6	Ethos 9	Legato 5	Prana 8
Calliope 8	Ever After 7	Levity 9	Preamble 8
Cambridge 6	<b>Expo 1</b>	Liquid 5	Preen 7
Candid 7	Fairfax 5	Loft 7	Prego 6
Capture 7	Fedora 6	Lucent 8	Pronto 5
Cardigan 6	Finale 6	Lure 8	Proposal 6
Carlisle 7	Fireside 7	Lyra 6	Purity 6
Carriage 8	Fizz 6	Mana 8	Pursuit 6
Census 7	Flight Of Fancy 9	Margin 6	Queue 7
Centre 6	Form 5	Marquee 6	Quip 5
Chai 7	Fuse 3	Mastermind 6	Racer 6
Chance 6	Gauge 3	Matter 9	Ratio 3
Chase 5	Gesture 9	Maven 6	Realm 6
Chronicle 5	Get Cozy 7	Meridian 5	Relevant 8
Cinch 3	Glimpse 7	Meta 8	Render 8
Circuit 5	Great Escape 8	Mime 4	Renewal 7
Classico 6	Greet 6	Mira 6	Repose 8
Click 5	Gusto 6	Moda 3	Revive 8
Clio 7	Hadleigh 6	Navigate 8	Riche 7
	Hamlet 8	Nouveau 6	Ritual 6
	Hero 6	Oblique 4	

### UPHOLSTERY LEGEND SYMBOLS

Please note, patterns in **bold type** are part of HPFI's standard fabric program. See pages 239-242 for color ways available.

## MOMENTUM FABRICS & GRADES: (CONTINUED)

### FABRICS

Ritual 6  
 Rival 5  
 Russo 3  
 Saguaro 7  
 Savant 6  
 Scene 6  
 Schema 6  
 Seabrook 8  
 Sector 4  
 Sense 8  
 Sequence 6  
 Serica 7  
 Shoot The Curl 9  
 Shore Thing 8  
 Signature 6  
 Snap 7  
 Snug 6  
 Sojourn 9  
 Solo 6  
 Solo2 6  
 Soprano 6  
 Soul 6  
 Spectra 5  
 Stance 6  
 Stir 6  
 Strategy 6  
 Sun Spell 10  
 Surreal 7  
 Suspense 9  
 Sync 5  
 Tally 5  
 Tandem 6  
 Tangent 4  
 Taos 7  
 Tate 3  
 Tek 7  
 Theory 7  
 Theta 7  
 Tilbury 6  
 Tone 8  
 Trance 5  
 Transfix 8

Traverse 7  
 Trek 3  
 Tribe 6  
 Turnabout 8  
 Twelve 7  
 Twirl 6  
 Ultima 7  
 Umi 7  
 Urbane 7  
 V.I.P. 6  
 Valet 6  
 Vario 6  
 Veer 9  
 Vega 6  
 Veil 5  
 Venue 6  
 Versus 5  
 Vicinity 6  
 Village 9  
 Vox 3  
 Weekender 10  
 Wellspring 9  
 Whistler 6  
 Whiz 8  
 Winsome 6  
 Wonder 7  
 X-Factor 9  
 Zillion 8  
 Zone 6

### VINYL

Agora 6  
 Carouse 10  
 Cashmere 5  
 Echo 8  
 Glam 6  
 Identity 10  
 Imprint 10  
 Innuendo 10  
 Lumiere 7  
 Masque 10  
 Max 7  
 Periphery 10  
 Rein 7

### Silica 9

Sublime 7  
 Tact 8

### CRYPTON

Brea 10  
 Caption 10  
 Crux 10  
 Crypton Suede 7  
 Delmonico 10  
 Evoke 8  
 Flurry 9  
 Hermosa 10  
 Hub 10  
 Huntington 10  
 Hyphen 9  
 Infusion 10  
 Isla 8  
 Jax 10  
 Jest 10  
 Jolt 8  
 Locale 10  
 Maxim 10  
 Niche 9  
 Query 10  
 Redux 8  
 Rio 9  
 Scoupe 10  
 Scribe 7  
 Smart Suede 7  
 Tweed 9  
 Zoom 9

### PVC-FREE

Beeline 6  
 Bravo 7  
 Canter 5  
 Foray 7  
 Icon 9  
 Paragon 9  
 Radiate 9  
 Rebel 9

### UPHOLSTERY LEGEND SYMBOLS

Please note, patterns in **bold type** are part of HPFI's standard fabric program. See pages 239-242 for color ways available.

All HPFI seating products are available in upholsteries from CF Stinson. The patterns listed below have been graded in for your convenience and ease in ordering Customer's Own Material (COM). CF Stinson patterns not listed below must be priced by our Customer Service department. Simply provide the HPFI model number, quantity and selected CF Stinson pattern to your HPFI Customer Service representative to confirm availability, pricing and lead time. For more information on CF Stinson, visit their web site at [www.cfstinson.com](http://www.cfstinson.com).

## C.F. STINSON FABRICS & GRADES:

### FABRICS

About Face 10  
 Ace 5  
 Arezzo 7  
 Blinker 8  
 Bryant Park 3  
 Chauncey 6  
 Confetti 4  
 Echo 9  
 Enduro II\* 4  
 Enduro III 4  
 Feelin' Groovy 8  
 Fender Bender 7  
 Frond 9  
 Glacier 4  
 Halo 6  
 Happy Hour 7  
 Highwire 6  
 Interplay 8  
 Lantana 10  
 Lindley Park 4  
 Maywood 8  
 New Hempstead 4  
 Pinwheel 7  
 Ramble 8  
 Rear View 9  
 Seedling 7  
 Serenity 10  
 Squiggle 9  
 Static 9  
 Stencil 5  
**Thicket 5**  
 To the Point 7  
 Transcend 4  
 Vision 5  
 Vroom Vroom 9

### PERFORMANCE/CRYPTON

Adirondack 10  
 Amp 10  
**Arc 7**  
 Balance Beam 10  
 Bali 10  
 Beau Monde 10  
 Beeline 10  
 Beep Beep 10  
 Boutique 10  
 Bower 9  
 Breeze 8  
 Carat 10

Catwalk 9  
 Celeste 10  
 Chloe 9  
 Compass 7  
 Couplet 10  
 Cozy 9  
 Crush 10  
 Crypton Metro 7  
 Crypton Suede 7  
 Crypton Suede Too! 7  
 Dashboard 10  
 Equinox 9  
 Estate Too! 10  
**Free Hand 7**  
 Glimmer 10  
 Hands On 10  
 Impulse 10  
 Indulgence 10  
 Isabeau Too! 10  
**Jambi Stripe 10**  
 Jasmine Screen 10  
 Kiawah 10  
 Line Dance 8  
 Linus 9  
 Match Point 9  
 Mingle 10  
 Modulation 7  
 Next Scene 10  
**On the Money 8**  
 Paradise 10  
 Parapet 10  
 Pathways 9  
 Persuasion 8  
 Placid 10  
 Prestige 10  
 Raquette 10  
 Saranac 9  
 Second Act 10  
 Slide Rule 8  
 Snuggle 7  
 Spandrel 10  
 Splash 10  
 Squire 8  
 Stipple 7  
 Straight and Narrow 10  
 Sumatran Palm 10  
 Tiles Too! 10  
**Tracing 7**  
 Tree House 8  
 Tweed 10  
 Twist 10

Veranda 7  
**Vibe 9**

### VINYL

Abacus 10  
 All American 3  
 Alloy 10  
 Aspen 10  
 Atmosphere 5  
 Avant 4  
 Banyan 10  
 Bari 10  
 Bistro 4  
 Bon Voyage 10  
 Budget Black 2  
 Berkshire 5  
 Capreni 10  
 Carlisle 5  
 Casablanca 10  
 Cassidy 5  
 Chamea 4  
 Chamea II 4  
 Checkmate 5  
 Chroma 7  
 Cirque 7  
 Classic Twill 5  
 Colorguard 4  
 Dash 7  
 Dodgeball 9  
 Duration 5  
 New Duration 5  
 Eli 10  
 English Pub 5  
 Excursion 7  
 Expressions 5  
 Facet 6  
 Finite 7  
**Fizz 6**  
 Fleur 5  
 GeoMet 6  
 Grand Sierra 4  
**Juxy 10**  
 Kilkenny Tweed 5  
**Laredo 4**  
 Liquid 7  
**Martini 10**  
 Matrix 7  
 Moccasin 4  
 Natural World 10  
 Naugaleather 5  
 Naugasoft 4

Neochrome III 4  
 Oakwood 4  
 Olympus 10  
 Oxford 5  
 Patriot Plus II 4  
 Petals 9  
 Prisma 10  
 Raffia 6  
 Rally 3  
 Renaissance 5  
 Rialto 5  
 Rivera 10  
 Rogue II 4  
 Savoy 5  
 Scribe 7  
 Script 7  
 Shantung 5  
 Simplicity 5  
 Sleek 6  
 Smile 10  
 Southampton 6  
 Sphere 7  
 Spirit Millennium 4  
 Stat-Con 9  
 Stratford 4  
 Surfside 4  
 Symphony Classic 5  
 Tendril 5  
 Tessuto 6  
 Trax 7  
 Tucson 8  
 Twilight 5  
 Valise 9  
 Vegas 4  
 Walk the Line 10  
 Whisper 4  
 Whitney 6  
 Ybor 10  
 Ziggy 5  
 Zodiac 6

### PVC-FREE

Arioso 9  
**Dakota 5**  
 In the Round (w/StaKleen) 7  
 Napa 7  
 Pinstripe 10  
 Sundance (w/StaKleen) 7

### C.F. STINSON UPHOLSTERY LEGEND SYMBOLS

# QUICK SHIP FABRICS



- *Quick Ship fabrics can be applied to any HPFI Seating*
- *Products can be shipped in 3 business days if specified on P.O.*
- *61 Choices!*

## SOOTHE CRYPTON®

PATTERN	COLOR	GRADE
Gold .....	03 .....	3
Red .....	06 .....	3
Navy.....	16 .....	3

## PAVERS CRYPTON®

PATTERN	COLOR	GRADE
Black Gold.....	09 .....	3
Brick.....	35 .....	3
Blue Water.....	31 .....	3

## FOUNDATION 10

PATTERN	COLOR	GRADE
Parade Blue .....	350-034 .....	2
Wine.....	350-001 .....	2
Cornsilk .....	350-002 .....	2
Jodhpurs .....	350-017 .....	2
Ebony .....	350-006 .....	2

## PRECISION

PATTERN	COLOR	GRADE
Black.....	498 .....	2
Beige .....	3175 .....	2
Green .....	8477 .....	2

## KINETIC

PATTERN	COLOR	GRADE
Black Gold.....	808 .....	2
Blue.....	809 .....	2
Ruby.....	811 .....	2

## SKETCH

PATTERN	COLOR	GRADE
Carbon.....	812 .....	2
Cardinal .....	813 .....	2
Denim.....	814 .....	2
Hunter .....	815 .....	2

## CARRARA VINYL

PATTERN	COLOR	GRADE
Buck.....	CR510 .....	2
Black .....	CR500 .....	2

## SWAY

PATTERN	COLOR	GRADE
Blue Sea .....	8454 .....	1
Red River .....	4642 .....	1
Silver Fish .....	0621 .....	1
Sand Dollar.....	5506 .....	1

## PRISM

PATTERN	COLOR	GRADE
Brick.....	741 .....	1
Ocean.....	742 .....	1
Pebble.....	745 .....	1
Slate .....	744 .....	1

## ROYALTY

PATTERN	COLOR	GRADE
Merlot .....	752 .....	1
Bouquet .....	753 .....	1
Green.....	755 .....	1
Pewter.....	757 .....	1

## PERK

PATTERN	COLOR	GRADE
Walnut .....	970 .....	1
Crimson.....	971 .....	1
Sesame.....	972 .....	1

## QUATTRO

PATTERN	COLOR	GRADE
Deep Crimson ..	300-001 .....	1
Dark Orchid ...	300-005 .....	1
Chalk .....	300-007 .....	1

## CORE

PATTERN	COLOR	GRADE
Eve .....	950 .....	1
Shale .....	953 .....	1
Vital .....	954 .....	1
Macro .....	952 .....	1

## EXPO

PATTERN	COLOR	GRADE
Sky.....	960 .....	1
Sprout .....	961 .....	1
Leaf.....	962 .....	1
Latte .....	963 .....	1
Festive .....	964 .....	1
Fog .....	965 .....	1
Lemon.....	966 .....	1

## JAMESTOWN VINYL

PATTERN	COLOR	GRADE
Green.....	357 .....	1
Antique Blue.....	360 .....	1
Oxblood.....	361 .....	1

## WOODFORD FAUX LEATHER

PATTERN	COLOR	GRADE
Black.....	WO545 .....	1
Blueberry .....	WO543 .....	1
Burgundy .....	WO540 .....	1

## LEATHER

PATTERN	COLOR	GRADE
Hunter .....	AL06.....	L
Blackberry .....	AL04.....	L
Black .....	AL18.....	L



	AP Aspen	BLK Black	HCY Honey Cherry	MAH Mahogany	OAK Medium Oak	MOB Moab	FM Natural	NOK Natural Oak	PW Pearwood	WC Windsor Cherry	WAL Walnut	RM Rouge Mahogany	CCY Classic Cherry	ESP Espresso
<b>Healthcare</b>														
840 Recliner	•	•	•	•		•	•		•	•	•	•	•	•
830/831 Armcaps	•	•	•	•		•	•		•	•	•	•	•	•
<b>Meeting &amp; Breakroom</b>														
Milan				•										
Genesis Series	•	•	•	•		•	•		•	•	•	•	•	•
<b>Office Seating</b>														
Leaders Contemporary	•	•	•	•		•	•		•	•	•	•	•	•
Scoop Series	•	•	•	•		•	•		•	•	•	•	•	•
1200 Series	•	•	•	•	•	•	•	•	•	•	•	•	•	•
Trifecta 1600 Series	•	•	•	•		•	•		•	•	•	•	•	•
Quick Silver Series	•	•	•	•	•	•	•	•	•	•	•	•	•	•
3900 Series	•	•	•	•	•	•	•	•	•	•	•	•	•	•
Accent Guest	•	•	•	•		•	•		•	•	•	•	•	•
9100 Guest	•	•	•	•	•	•	•	•	•	•	•	•	•	•
992/993 Guest	•	•	•	•	•	•	•	•	•	•	•	•	•	•
900 Guest	•	•	•	•			•		•	•	•	•	•	•
Trados 910 Series	•	•	•	•		•			•	•	•	•	•	•
Unos Series	•	•	•	•		•			•	•	•	•	•	•
Contempo Guest	•	•	•	•		•	•		•	•	•	•	•	•
Traditional	•	•	•	•		•			•	•	•	•	•	•
Scoop Traditional	•	•	•	•		•			•	•	•	•	•	•
Value Traditional	•	•	•	•		•			•	•	•	•	•	•
<b>Ganged</b>														
992/993 Ganging				•	•			•		•				
Scoop Ganging	•	•	•	•	•	•	•	•	•	•	•	•	•	•
9118 Ganging				•	•			•		•				
Trados Ganging Tables	•	•	•	•		•			•	•	•	•	•	•
<b>Reception/Lounge</b>														
Himalaya 150 Series	•	•	•	•		•	•		•	•	•	•	•	•
Chesterfield 4300	•	•	•	•		•			•	•	•	•	•	•
Accompany 5900	•	•	•	•		•	•		•	•	•	•	•	•
Sophia 5200 Series	•	•	•	•		•	•		•	•	•	•	•	•
Lauren 6100 Series	•	•	•	•		•	•		•	•	•	•	•	•
Rebecca 6200 Series	•	•	•	•		•	•		•	•	•	•	•	•
Scarlet 6300 Series	•	•	•	•		•	•		•	•	•	•	•	•
Kimberly 6400 Series	•	•	•	•		•	•		•	•	•	•	•	•
6700 Series	•	•	•	•	•	•	•	•	•	•	•	•	•	•
7200 Series	•	•	•	•	•			•	•	•	•	•	•	•
7500 Series	•	•	•	•	•			•	•	•	•	•	•	•
7900 Series	•	•	•	•	•			•	•	•	•	•	•	•
8500/8600 HiLeg	•	•	•	•		•	•		•	•	•	•	•	•
8700/8800 HiLeg	•	•	•	•		•	•		•	•	•	•	•	•
9100 Series	•	•	•	•		•			•	•	•	•	•	•
Plaza 9600 - Arm Caps	•	•	•	•		•	•		•	•	•	•	•	•

**Custom Finishes** now available at \$100 one-time net charge for easy coordination with all elements of a facility. Contact Customer Service for details.

HPFI offers reception and ergonomic seating that has been tested and certified by an independent laboratory to pass California Bureau of Home Furnishings and Thermal Insulation's Technical Bulletin #133 flammability requirements. These are the most stringent U.S. flammability requirements. Testing includes full-scale burn testing of a finished, upholstered chair, which is destroyed after a single test. HPFI has chosen to use a barrier cloth or fire-blocking layer between the foam cushioning and the external upholstery cover in order to comply with California Technical Bulletin 133.

All HPFI TB 133-certified chairs have been tested and certified in 100% recycled polyester fabrics from the Foundation 10 collection, which offers 27 solid color crepe fabric options. These fabrics also pass 1,000,000 double rubs in surface abrasion testing (ASTM D 4157 Wyzenbeek Test). Reference Foundation 10 fabrics on page 239.

Unless otherwise noted, any upholstered HPFI reception or ergonomic seating unit can be specified and manufactured to comply with California Technical Bulletin #133. The upcharge for each piece is determined by multiplying its fabric requirement (as stated in this price list) by \$66 List per yard.

Example: For a Claudia Club Chair #5301, you would add \$412.50 List (6.25 yards at \$66 List per yard) to the regular list price.

If laboratory certification is required for a specific style and upholstery combination, the following costs to the requesting party will apply:

- \$1,000 NET for testing and transportation of sample
- Cost of test sample including appropriate upcharge as outlined above.

An additional 6 weeks will be added to the standard lead time for products requiring testing.

For more information and California Technical Bulletin #133 pricing, please contact your HPFI Customer Service Representative.

## ALL CHAIRS INCLUDE PNEUMATIC SEAT HEIGHT ADJUSTMENT

### SWIVEL SEATING



#### Swivel Tilt

- Swivels 360° and seat/back tilts as one unit
- Tilt pivot point located at top of column
- Adjustable tilt tension

#### Standard:

All Swivel Seating

#### Except:

- Basic (BM) Mechanism
- Cheetah/500



#### Knee Tilt with Tilt Lock

- Increased reclining comfort; feet rest flat on floor when reclining
- Tilt pivot point located toward front seat edge/knees
- Adjustable tilt tension
- Swivels 360° and seat/back tilt as one unit
- Adds 2" to chair height

#### Standard:

1231/1237  
181

#### Optional:

Leaders, Scoop, 1200, 1400, Trifecta, Quick Silver, 3900, Traditional, Scoop Traditional, Value Traditional

### FAST CATS COLLECTION



#### Full Feature (FM) & Seat Slider (FMSS) Mechanisms (FM) & (FMSS) Available:

- Back angle adjustment, forward seat tilt, tilt lock
- Adjustable back height and arm width
- Seat Slider (FMSS) includes all functions of (FM) mechanism above plus: Seat slides forward/back to adjust seat depth

Panther 330s  
Jaguar 320s



#### Synchro Tilt (YM) Mechanism

- 360° swivel tilt
- Back reclines at 2:1 ratio to seat angle. Allows user to recline while keeping seat cushion relatively level
- Tilt lock
- Adjustable tilt tension

#### Standard:

Nexstep Swivel Chairs, Puma, Cirrus

#### (YM) Available:

Panther 330s



#### Adjustable Back Height

- Raise/lower back for individual comfort
- Lift back to engage mechanism

#### Standard:

Full-Feature (FM) Mechanism  
SynchroTilt (YM) Mechanism  
621, 627

#### Optional:

Basic (BM) Mechanism  
Standard Upgrade (SM) Mechanism

#### Adjustable Seat Depth

- Back adjusts forward/back for individual comfort
- J-bar slides in/out of mechanism when knob loosened

#### Standard:

Basic (BM) Mechanism  
Standard (SM) Upgrade Mechanism

#### \*NOT AVAILABLE:

Full-Feature (FM) Mechanism  
SynchroTilt (YM) Mechanism



#### Adjustable Width Arms

- Adjusts left/right for individualized seat width comfort
- Loosen knob under seat that secures arm upright

#### Standard:

186, Cougar, Panther, Jaguar, Cheetah and Extended-Height Chairs with adjustable height arms.



#### Back Angle Adjustment

- Provides optimum lumbar support and extended range of motion
- Locks into position for hands free comfort.
- Relieves back pressure

#### Standard:

Full-Feature (FM) Mechanism  
621, 627



#### Forward Seat Tilt

- Releases seat to tilt forward during computer sessions
- Feet remain flat on floor and thighs in non-restrictive, horizontal position
- Relieves back pressure
- Further extends range of motion

#### Standard:

Full-Feature (FM) Mechanism  
621, 627



#### Tilt Lock

- Secures chair in position

#### Standard:

Full-Feature (FM) Mechanism  
621, 627

### CASTER OPTIONS

High Point seating features standard dual-wheel carpet casters applicable to most business environments.

#### Caster Kit

To convert a chair in the field from carpet casters to Hard Floor Casters, order a Caster Kit which includes 5 casters. List price is \$40.00.

#### Jury Base

A 9-1/4" base with 90° swivel (45° each side) and auto return to front/forward position is available on many Management swivel chairs. Specify JB and add \$315 list upcharge.

Sentinel™ finish employs silver ions - a powerful, natural antimicrobial, antibacterial which assists in preventing the spread of infections without harm to human health. Disease-causing organisms on wood chair frames with Sentinel™ antimicrobial silver remain latent, are unable to propagate and soon expire. Sentinel™ antimicrobial cannot be washed away, worn off or depleted overtime. Its effectiveness is as powerful at the end of the life cycle as it is at its start.

## FINISHES

The various finish combinations available for each chair model are specified by a wood finish code suffix. Wood finishes are available as noted on each page of the price list. The following legend for the wood finish code is listed at the bottom of each page of chair models available with wood finishes.

### WOOD FINISH CODES

- AP (Aspen)
- WC (Windsor Cherry)
- FM (Natural)
- MAH (Mahogany)
- MOB (Moab)
- NOK (Natural Oak)
- OAK (Medium Oak)
- PW (Pearwood)
- WAL (Walnut)
- HCY (Honey Cherry)
- BLK (Black)
- RM (Rouge Mahogany)
- C (Honey Cherry)
- ESP (Espresso)
- CCY (Classic Cherry)

When ordering, please specify the quantity of each model, the complete model number, followed by a dash, the wood finish code, followed by the fabric name and fabric number. Example: To order 15 of model 1621 in a Windsor Cherry finish in Prism 742 Ocean fabric, your order should read:

QTY	MODEL	WOOD FINISH	FABRIC NAME	FABRIC NUMBER
15	1621	WC	Ocean	742

Specifications of the finishes available at no additional charge with our various wood types are as follows:

1. On chairs with exposed wood parts of kiln dried maple and other similar hardwoods, the following finishes are available at no additional charge:
  - A. **Aspen** - a fade resistant beige stain

with a medium gloss lacquer top coat. Specify Wood Finish Code AP.

- B. **Windsor Cherry** - a fade resistant red-brown cherry stain with a medium gloss lacquer top coat. Specify Wood Finish Code WC.
- C. **Mahogany** - a fade resistant mahogany stain with a medium gloss lacquer top coat. Specify Wood Finish Code MAH.
- D. **Walnut** - a fade resistant walnut stain with a medium gloss lacquer top coat. Specify Wood Finish Code WAL.
- E. **Natural** - a clear lacquer gloss top coat. Specify Wood Finish Code FM.
- F. **Pearwood** - a fade resistant pearwood stain with a medium gloss lacquer top coat. Formulated to match our cherry laminate casegood finish. Specify Wood Finish Code PW.
- G. **Honey Cherry** - a fade resistant orange-brown cherry stain with a medium gloss lacquer top coat. Formulated to match our Honey Cherry veneer casegoods. Specify Wood Finish Code HCY.
- H. **Black** - a fade resistant black stain with a low-gloss lacquer top coat. Specify Wood Finish Code BLK.
- I. **Moab** - a fade resistant medium-brown stain with a medium-gloss top coat. Specify Wood Finish Code MOB.
- J. **Rouge Mahogany** - multi-step red/brown finish with high-gloss top coat matching veneer casegoods. Specify Wood Finish Code RM.
- K. **Honey Cherry** - multi-step orange/brown finish with high-gloss top coat matching veneer casegoods. Specify Wood Finish Code C.
- L. **Espresso** - a fade resistant dark Walnut stain with a medium gloss lacquer top coat. Specify wood Finish Code ESP.
- M. **Classic Cherry** - a fade resistant Cherry stain with a medium gloss lacquer top coat. Specify wood Finish Code CCY.

2. On chairs with exposed wood parts of kiln dried genuine oak and other similar hardwoods, the following finishes are available at no additional charge:

- A. **Natural Oak** - a clear, medium gloss lacquer top coat. Specify Wood Finish Code NOK.
- B. **Medium Oak** - a fade resistant medium-brown oak stain with a medium gloss lacquer top coat. Specify Wood Finish Code OAK.

3. Special finishes can be accommodated. Please call our customer support department for pricing and lead time.

Due to special handling, a special finish charge at \$100 one-time net is required.

PLEASE NOTE: Variations in wood color and grain pattern, contribute to the natural beauty of wood. The natural characteristics of the different species of wood, add to the distinctiveness of furniture and cannot be considered defects.

Examples of natural characteristics; pitch pockets (which are common in fruit woods such as cherry), appear as a dark spot in the grain that may not always completely accept finishing materials, darkness of end-grain on the edges of desktops, color variation of growth ring commonly called "tiger striping", slight variations in color from piece to piece.

All real wood products exhibit a certain amount of color variation when finished. This color variation is most often caused by the natural difference of initial color of the raw wood. This initial color, as with many other of the characteristics of real wood, is naturally occurring and contributes to the beauty of the finished product. These color variations are more noticeable in light colored woods finished with a clear lacquer finish. We strive to control variations in color as much as practical, however, slight variations are not defects.

## DIMENSIONS

All size dimensions are nominal and subject to change. If you must have exact dimensions, please contact your Customer Service Representative. Worksurface dimensions will vary due to edge profile treatment. Always measure actual top before ordering glass or other cover to fit tops.

## FABRICS

Our patterns offer the best in appearance, durability, and value. Please refer to the seating warranty section on page 6 for more information. Fabrics are ordered as soon as we receive your order. Therefore no cancellations or changes are allowed once your order is received and the fabrics are ordered. Please let your customer know this when they are making their fabric selections.

### A. FABRIC INTRODUCTION

Even though the fiber industry has not developed any totally new fibers in the past decade, researchers are making strides in the blending and finishing of fibers to produce new aesthetic qualities and enhancing existing performance characteristics. Man-made fibers such as acrylic, olefin, polyester and nylon have achieved new levels of performance with current changes necessitating a true evaluation of each fabric on its own merit. Do not assume that a specific fabric is always the best. Consult the test results on the reverse side of the fabric card and evaluate its performance for your particular application. HPFI chooses only those fabrics that attain the upper portion of the durability spectrum.

### B. FABRIC TESTING TERMS

- Surface Abrasion** - The degree to which a fabric is able to withstand surface wear, rubbing, chafing, and other friction forces. Light Duty Fabrics – 3,000 cycles (double rubs) Medium Duty Fabrics – 9,000 cycles (double rubs) Heavy Duty Fabrics – 15,000 cycles (double rubs)
- Crocking** - The degree of resistance of material to change color characteristics, or transfer its color to other materials in any environment during the life of the fabric.
- Tear Strength** - The force necessary to tear a fabric, usually expressed in pounds or in grams. The most commonly used method for determination of tear strength is the ELEMENDORF tear test procedure.
- Tensile Strength** - The actual number of pounds of resistance that a fabric will give to a breaking machine before the material is broken.
- Fadometer/Color Fastness** - The fadometer (light) test determines the resistance of a specific fabric color to prolonged exposure to sunlight utilizing a water-cooled xenon lamp fading apparatus for simulation. The color fastness test determines the degree of color retention and change in shade (or lack of) during the normal life of the fabric.
- Fire Retardant** - Fabrics treated with special chemical agents or finishes to make them retardant or resistant to burning. Today, many fabrics achieve this property by using fibers that have this property built directly into the polymer. Fire retardant coatings or specifications vary according

to code requirement. Please consult fabric specifications listed with each pattern in upholstery catalog for specific code acceptability.

- Dupont Teflon® Fabrics Protector** is a durable fluorochemical that guards against spills, stains and soiling, and is always professionally applied. Dupont Teflon® keeps stains from penetrating fibers, so oil and water based stains can be blotted up quickly and dust and dry soil can be easily wiped away. Immediate clean up is required to prevent staining.

### C. FIRE RETARDANT PRODUCTS & SPECIAL CODES

- Treatment or finishing of fabrics has become varied and complicated because many states and municipalities have developed their own criteria for fire retardant coverings. Although attempts have been made to offer a fabric which will pass as many of these codes as a group (e.g. Boston Fire Dept. Std., The Port Authority of N.Y. and N.J., and Calif. Bulletin 117-E), it may be necessary to specifically treat a fabric for a special code. If special treatment is required, or if treatment of a current fabric offered by HPFI to meet a certain code is required, please contact our Customer Service Department for costing.
- Consult specifications in upholstery catalog for pertinent fire code ratings and specifications, or request a specification sheet from our Customer Service Department.
- Please remember that a fire retardant fabric isn't fireproof or flameproof. The purpose of the retardant finish is to make fabrics flame resistant to provide time for egress.
- California Technical Bulletin #133 requires heightened levels of flammability resistance and special testing. High Point offers a wide range of seating tested to Cal 133. Contact customer service for more information.

### D. CLEANING CODES:

- Each fabric offered by HPFI has a cleaning code letter, assigned by the fabric manufacturer for a specific pattern, and listed on the swatch card. The cleaning codes are as follows:  
**W** - Water based cleaners may be used.  
**S** - Solvent based cleaners may be used.  
**WS** - Water or solvent based cleaners may be used.  
**X** - Do not use any cleaning fluids.
- To prevent overall soiling, frequent vacuuming or light brushing to remove dust and grime is recommended.
- Always pre-test a small inconspicuous area before proceeding to remove the stain.

### VINYLS

**Vinyl Introduction:** Vinyl coverings are normally 100% virgin vinyl (a synthetic formulation) supported by a man-made

backing, sometimes textured and then surface finished or capped with a chemical film. Vinyl can be formulated to enhance its resistance to bacteria, flammability, discoloration, abrasion and chemical attack. Consult the technical information on the back of the vinyl swatch cards to choose the desired characteristics for the environmental setting in which the seating units will be used.

**Vinyl Protection:** Periodic cleaning of the vinyl by washing with lukewarm water and a mild soap will prevent hardening, cracking and peeling due to body oils and oil products used for grooming. Clean with wet sponge and dry with dampened cloth or sponge. Certain commercially available products clean routine spills effectively.

### LEATHERS

**Leather Introduction:** Leather, by virtue of its natural inherent beauty, warmth and durability, creates aesthetic appeal for those individuals desiring the very finest in office seating. The exclusive use of top grain cowhides by HPFI in Grade L, assures the customer of genuine leather as opposed to split or bonded leather substitutes. The growth marks and healed scars which occur during the animals' lifetime give leather its distinguishing "signature". These signatures will appear on the chair leather, assuring the customer of the use of authentic top grain hides. Genuine top grain leather mellows with age and gains a quality and value which is unlike any man-made substitute.

### Full and Top Grain Leather vs. Split

**Leather:** When the hide is separated from the animal, it can be as much as 3/4" thick. A splitting machine then splits the hide into layers of desired thickness. Only the first cut is used in HPFI chairs, insuring maximum strength and beauty of the product. To remove spots and spills, wipe excess liquid up immediately with a clean absorbent cloth or sponge. If necessary, use clean lukewarm water only and let air dry naturally. If water is used, clean the entire area where the spot occurred. An example would be the entire seat cushion or entire arm. DO NOT dry wet areas with hair dryers, etc. For butter, oil or grease, wipe excess butter, oil or grease off the leather with a clean dry cloth, then leave it alone as the spot should dissipate into the leather in a short period of time. DO NOT apply water or try to wash such spots.

**Please Note:** These are recommended or suggested methods of cleaning. The manufacturer is not responsible for damage incurred while cleaning.



## COM FABRICS/COL LEATHER (CUSTOMER'S OWN MATERIAL)

Special upholstery material furnished to the company by the customer receives special processing. Prior to HPFI accepting any COM orders, a COM fabric sample and the Authorization Request Form (see page 358) must be submitted to HPFI for yardage requirements. Once this form is returned to you, you can order your upholstery to be sent to HPFI.

Any orders received without accompanying fabric will be entered and acknowledged with an open shipping date until fabric is received.

Inquiries should be sent to:

HPFI  
COM/COL - Customer Service  
1104 Bedford St.  
High Point, NC 27263  
P: (800) 447-3462  
F: (800) 231-6784  
info@hpfi.com

### A. COM/COL Shipping Address

Ship all COM/COL fabrics and leather prepaid to:

HPFI  
COM/COL - Customer Service  
1104 Bedford St.  
High Point, NC 27263

Make sure a copy of the COM/COL order form is attached to the fabric (see page 358). CODs not accepted on customer's own material (COM) or customer's own leather (COL).

### B. General COM/COL Information:

1. Do not fold either fabric or leather for shipment. All fabric and leather must be rolled on a cardboard tube for shipment to HPFI. Folded fabric or leather may sustain permanent creasing, rendering it unsuitable for upholstery purposes. HPFI will not apply creased goods to any upholstered item(s).
2. For specific yardage requirement for large repeats or large orders, send memo sample with COM/COL order form request (page 358) to the address above. Chair models and quantities are required. A timely reply will be forwarded with yardage required.
3. COM orders are billed at Grade 2 price.
4. COL orders are billed at Grade 3 price.

### C. Warranty and Application of COM/COL Coverings:

1. Upholstery coverings received from the vendor or customer for COM/COL applications are not covered by any warranties expressed or implied by HPFI including but not limited to wearability light fastness or tailoring.
2. While we make every effort to check and cut COM material in the most appropriate manner, claims for flaws, insufficient yardage, discrepancies in the fabric, imperfections in the material, dye lot variations, or wearing quality of material furnished by the customer cannot be honored.
3. Do not figure COM yardage from yardage in the price book. Yardage requirements shown in this price list are based on the use of non-directional fabric 54" wide applied in a "Topped" orientation.
4. Please fill COM/COL form completely including topped out or railroaded applications also add horizontal and vertical repeats.

### D. COM/COL Shipping Dates:

1. If an acknowledged order contains both regular and COM/COL units on the same order, the order will be processed with an open ship date. Once the COM/COL fabric is received, standard lead times will apply to the entire order.

## FABRIC COMBINATIONS

Many seating items may be selected with multiple upholstery covers on a single unit, such as vinyl arms and fabric seat/back or solid color fabric arms with pattern fabric seat/back. HPFI can accommodate these special requests as outlined below.

- A. Indicate clearly on original order the combination of desired fabrics as follows:
  - Chair Model
  - Finish (if applicable)
  - Seat fabric
  - Back fabric
  - Arm fabric

If seat/back will be same fabric, order can list it as such.
- B. Be certain to provide complete description of fabrics/vinyls, including pattern name, color name, and color number.
- C. Pricing is based on the below list price upcharges added to the highest grade fabric included on the piece.

### Two-Color Combinations (Add upcharge to the highest fabric price grade featured on the unit.)

Chair	\$32 list
Club Chair/Recliner	\$53 list
Loveseat/Day Bed	\$74 list
Sofa	\$96 list

### Three-Color Combinations (Add upcharge to the highest fabric price grade featured on the unit.)

Chair	\$53 list
Club Chair/Recliner	\$74 list
Loveseat/Day Bed	\$96 list
Sofa	\$138 list

- D. Combinations are available on standard and alliance program fabrics at standard lead time (not via Quick Ship). Combinations using COM fabrics may require additional lead time and must follow the COM order process.



## ERGONOMIC FEATURES & APPLICATIONS

Ergonomics, also referred to as Biotechnology of Human Engineering, is an applied science concerned with the characteristics of people that need to be considered in designing and arranging things that they use in order that people and things will interact more effectively, comfortably, and safely.

With respect to the office worker, ergonomics is applied to accommodate specific work postures that reduce or eliminate static loading of muscles, particularly in the neck, shoulder and lower back regions. These are the primary areas where musculo-skeletal illnesses occur, causing discomfort and pain.

In recent years we have, through the study of ergonomics, gained an increased understanding of the importance of prevention, in contrast to cure, for the seated individual. The result is new seating designs incorporating proper curvatures as well as individual adjustability. This seating construction has the following features and benefits:

- Front of seat is a “waterfall” shape - avoids restriction of circulation of blood in thighs and lower legs.
- Back support is designed with a compound curve to support lumbar vertebrae and help back hold a slightly forward arch. Fixed Lumbar Support has been incorporated into various chairs. Permanent fixed support allows proper passive ergonomic alignment of the skeletal frame.
- Seat cushion has only light but relatively firm padding so the buttocks can change pressure areas easily. Most seats are constructed with matrix support, as opposed to a platform (solid) seat pan. This increases comfort and works to reduce or eliminate pressure areas.
- Seat height is adjustable to accommodate both taller & shorter workers.
- Seat controls are designed to be able to adjust both back and seat for various positions and tasks.
- For safety, the chair bases have 5 prongs. This also makes movement easier.

As well as having all of the above features and benefits required to satisfy tasks that need to be performed. HPFI seating blends into the most discriminating office environment. Actuating paddles and knobs are positioned within easy reach from the seated position, and at the same time placed to avoid injury or inadvertent operation.

## BASES

### A. Wood Base:

A five prong steel understructure is continuously welded to a steel center hub for strength and durability. The center hub is equipped with a nylon hub liner to provide smooth and quiet swivel operation. Hardwood caps are secured to the steel understructure. **The base is furnished with a black metal sleeve and features black polyimide, non-abrasive, non-marking dual wheel casters.** These bases meet or exceed all BIFMA requirements. Optional additional casters are available.

### B. Low-Profile Base:

Optional Leaders base features 5-prong die-cast aluminum under structure. Flat hardwood caps are finished and affixed to under structure. Contemporary style. Meets or exceeds all BIFMA requirements.

### C. Black Nylon Base:

Black five prong base of reinforced nylon resin. The base features integrated two inch hooded dual wheel casters, which meet or exceed all BIFMA requirements.

**Please Note:** The black nylon five prong base can be substituted for a five prong wood base at no up charge.

**IMPORTANT:** When ordering a replacement base or casters, please list the seating model number and the date of purchase (if known), found on the manufacturer label under the upholstered item.

## PACKING

Prices quoted herein include packing. All items are packed one to a carton, except where indicated. All packing conforms to or exceeds minimum specifications as outlined in the Uniform Freight Classification.

We reserve the right to change or modify any of our products, pricing, or our packaging without notice.

# COM/COL WORKSHEET

## CUSTOMER INFORMATION

Account Number \_\_\_\_\_ Date \_\_\_\_\_  
 Dealer Name \_\_\_\_\_ Contact \_\_\_\_\_  
 Billing Address \_\_\_\_\_  
 City \_\_\_\_\_ State \_\_\_\_\_ Zip \_\_\_\_\_  
 Phone \_\_\_\_\_ Fax \_\_\_\_\_ Email \_\_\_\_\_

## FABRIC INFORMATION

Mill/Supplier \_\_\_\_\_ Pattern Name \_\_\_\_\_ Style# \_\_\_\_\_  
 Color \_\_\_\_\_ Fabric Content \_\_\_\_\_  
 Description \_\_\_\_\_

Please circle either "Railroad" or "Topped" orientation

**Railroad**

**OR**

**Topped**

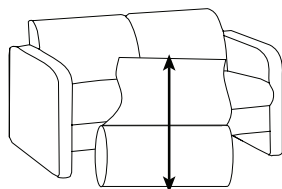
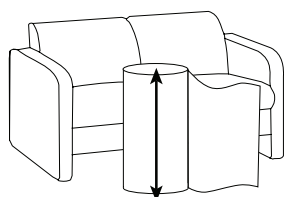

Check your COM memo sample for Railroad or Topped specification

### Repeat Size (in inches):

Vertical \_\_\_\_\_

Horizontal \_\_\_\_\_

- COM/COL orders will not be scheduled for production until all fabric has been received.
- COM is priced at Grade 2
- COL is priced at Grade 3
- Yardage requirements shown in price list are based on the use of non-directional fabric 54" wide applied in "Topped" orientation.

## ORDER INFORMATION

Fax completed form to 1-800-231-6784

QUANTITY	SEATING MODEL	DESCRIPTION	PO#

HPFI does not warranty quality assurance of COM/COL material. It is the responsibility of the supplier. Please see Technical Specifications in HPFI Price Book.

### HPFI Use Only

**Fabric Authorization** - Fabric Approved

Fabric Not Approved

COM Yardage Requirement (Per Instructions) \_\_\_\_\_

Date \_\_\_\_\_ Signature \_\_\_\_\_

To help expedite your order, we recommend the COM supplier to include the following information on packing list:

1) Dealer Name

2) Purchase Order Number

Ship Prepaid To: HPFI c/o COM Coordinator  
 1104 Bedford Street  
 High Point, NC 27263

# SEATING



# CIRRUS SIN 711-18

MESH BACK OFFICE SEATING

## The Ultimate in Style & Comfort

The **Cirrus** collection offers the ultimate in comfort and style. The dual knit mesh backs provide a passive lumbar support that literally hugs your back. With easily adjustable height and width arms, the Executive and Management versions will adapt to practically any body size. A 5-position tilt-lock mechanism with tension adjustment is standard. A knee-tilt mechanism which moves the pivot point of the seat towards the front is also available. A unique, optional 6-position seat slider mechanism effectively extends the seat by 2.5" for those with longer legs.

**Please Note:** Mesh back and seat pan perimeter are available in three (3) colors: Black, Blue or Rouge. Black is standard and, therefore, does not require specification. To specify Blue or Rouge, add "B" for Blue or "R" for Rouge at the end of the model number.

## Cirrus Design Details

- Passive lumbar knit mesh back
- Braking casters
- 5 Position synchro-tilt mechanism
- Height/width adjustable or loop arms

## Upholstery & Base Color Options

- 3 Standard Knit Colors (Black, Blue, Rouge)
- Choose from 3 standard or 6 custom knit colors combined with thousands of available upholsteries
- Full upholstered chairs also available
- Bases available in chrome or black



788 with loop arms  
781CB with chrome base

## Cirrus

### 781 Executive Swivel Chair, Black Base

24-27.75" W X 32.5" D X 43.5-47.25" H

St. Yardage: 1



Freight Class: 150  
Cubic Ft: 23  
Ship Weight: 52

Grade	1	2	3	4	5	6	7	8	9	10	L	LL
Zone 1	947	968	987	999	1015	1037	1045	1080	1102	1129	1193	1303
Zone 2	961	983	1002	1014	1030	1053	1061	1096	1119	1146	1211	1323
Zone 3	975	997	1017	1029	1045	1068	1076	1112	1135	1163	1229	1342

- Passive lumbar in knit mesh back
- Seat mimics back design
- Black back is standard
- Height and width adjustable T-arms
- Can be ordered with Blue or Rouge back
- Black five prong base with braking casters
- 5-position Synchro-tilt mechanism
- Seat is 19.5"W X 19"D X 16.5-20" H

OPTION	PRICE	CODE
Sliding Seat	85.00	SS
Adjustable Lumbar	25.00	Z

### 781CB Executive Swivel Chair, Chrome Base

24-27.75" W X 32.5" D X 43.5-47.25" H

St. Yardage: 1



Freight Class: 150  
Cubic Ft: 23  
Ship Weight: 54

QS

Grade	1	2	3	4	5	6	7	8	9	10	L	LL
Zone 1	1027	1047	1066	1079	1095	1117	1125	1160	1182	1209	1272	1383
Zone 2	1042	1063	1082	1095	1111	1134	1142	1177	1200	1227	1291	1404
Zone 3	1058	1078	1098	1111	1128	1151	1159	1195	1217	1245	1310	1424

- Passive lumbar in knit mesh back
- Seat mimics back design
- Black back is standard
- Height and width adjustable T-arms
- Can be ordered with Blue or Rouge back
- Chrome five prong base with braking casters
- 5-position Synchro-tilt mechanism
- Seat is 19.5"W X 19"D X 16.5-20" H

OPTION	PRICE	CODE
Sliding Seat	85.00	SS
Adjustable Lumbar	25.00	Z

**787 Management Swivel, Black Base**

24-27.75" W X 32.5" D X 37.5-41" H St. Yardage: 1



Freight Class: 150  
Cubic Ft: 20  
Ship Weight: 50

**QS**

Grade	1	2	3	4	5	6	7	8	9	10	L	LL
<b>Zone 1</b>	<b>923</b>	<b>942</b>	<b>961</b>	<b>975</b>	<b>991</b>	<b>1013</b>	<b>1021</b>	<b>1056</b>	<b>1078</b>	<b>1105</b>	<b>1169</b>	<b>1279</b>
<b>Zone 2</b>	<b>937</b>	<b>956</b>	<b>975</b>	<b>990</b>	<b>1006</b>	<b>1028</b>	<b>1036</b>	<b>1072</b>	<b>1094</b>	<b>1122</b>	<b>1187</b>	<b>1298</b>
<b>Zone 3</b>	<b>951</b>	<b>970</b>	<b>990</b>	<b>1004</b>	<b>1021</b>	<b>1043</b>	<b>1052</b>	<b>1088</b>	<b>1110</b>	<b>1138</b>	<b>1204</b>	<b>1317</b>

- Passive lumbar in knit mesh back
- Seat mimics back design
- Black back is standard
- Height and width adjustable T-arms
- Can be ordered with Blue or Rouge back
- Black five prong base with braking casters
- 5-position Synchro-tilt mechanism
- Seat is 19.5"W X 19"D X 16.5-20" H

OPTION	PRICE	CODE
Sliding Seat	85.00	SS
Adjustable Lumbar	25.00	Z

**787CB Management Swivel, Chrome Base**

24-27.75" W X 32.5" D X 37.5-41" H St. Yardage: 1



Freight Class: 150  
Cubic Ft: 20  
Ship Weight: 53

**QS**

Grade	1	2	3	4	5	6	7	8	9	10	L	LL
<b>Zone 1</b>	<b>1002</b>	<b>1023</b>	<b>1042</b>	<b>1054</b>	<b>1070</b>	<b>1092</b>	<b>1100</b>	<b>1135</b>	<b>1157</b>	<b>1184</b>	<b>1248</b>	<b>1358</b>
<b>Zone 2</b>	<b>1017</b>	<b>1038</b>	<b>1058</b>	<b>1070</b>	<b>1086</b>	<b>1108</b>	<b>1117</b>	<b>1152</b>	<b>1174</b>	<b>1202</b>	<b>1267</b>	<b>1378</b>
<b>Zone 3</b>	<b>1032</b>	<b>1054</b>	<b>1073</b>	<b>1086</b>	<b>1102</b>	<b>1125</b>	<b>1133</b>	<b>1169</b>	<b>1192</b>	<b>1220</b>	<b>1285</b>	<b>1399</b>

- Passive lumbar in knit mesh back
- Seat mimics back design
- Black back is standard
- Height and width adjustable T-arms
- Can be ordered with Blue or Rouge back
- Chrome five prong base with braking casters
- 5-position Synchro-tilt mechanism
- Seat is 19.5"W X 19"D X 16.5-20" H

OPTION	PRICE	CODE
Sliding Seat	85.00	SS
Adjustable Lumbar	25.00	Z

**788 Conference Chair, Black Base**

25.75" W X 32.5" D X 37.5-41" H St. Yardage: 1



Freight Class: 150  
Cubic Ft: 20  
Ship Weight: 54

**QS**

Grade	1	2	3	4	5	6	7	8	9	10	L	LL
<b>Zone 1</b>	<b>869</b>	<b>890</b>	<b>909</b>	<b>921</b>	<b>937</b>	<b>959</b>	<b>967</b>	<b>1002</b>	<b>1024</b>	<b>1051</b>	<b>1115</b>	<b>1225</b>
<b>Zone 2</b>	<b>882</b>	<b>903</b>	<b>923</b>	<b>935</b>	<b>951</b>	<b>973</b>	<b>982</b>	<b>1017</b>	<b>1039</b>	<b>1067</b>	<b>1132</b>	<b>1243</b>
<b>Zone 3</b>	<b>895</b>	<b>917</b>	<b>936</b>	<b>949</b>	<b>965</b>	<b>988</b>	<b>996</b>	<b>1032</b>	<b>1055</b>	<b>1083</b>	<b>1148</b>	<b>1262</b>

- Passive lumbar in knit mesh back
- Seat mimics back design
- Black back is standard
- Loop arms
- Can be ordered with Blue or Rouge back
- Black five prong base with braking casters
- Seat is 19.5"W X 19"D X 16.5-20" H

OPTION	PRICE	CODE
Sliding Seat	85.00	SS
Adjustable Lumbar	25.00	Z

**788CB Conference Chair, Chrome Base**

25.75" W X 32.5" D X 37.5-41" H St. Yardage: 1



Freight Class: 150  
Cubic Ft: 20  
Ship Weight: 56

**QS**

Grade	1	2	3	4	5	6	7	8	9	10	L	LL
<b>Zone 1</b>	<b>920</b>	<b>940</b>	<b>959</b>	<b>972</b>	<b>988</b>	<b>1010</b>	<b>1018</b>	<b>1053</b>	<b>1075</b>	<b>1102</b>	<b>1166</b>	<b>1276</b>
<b>Zone 2</b>	<b>934</b>	<b>954</b>	<b>973</b>	<b>987</b>	<b>1003</b>	<b>1025</b>	<b>1033</b>	<b>1069</b>	<b>1091</b>	<b>1119</b>	<b>1183</b>	<b>1295</b>
<b>Zone 3</b>	<b>948</b>	<b>968</b>	<b>988</b>	<b>1001</b>	<b>1018</b>	<b>1040</b>	<b>1049</b>	<b>1085</b>	<b>1107</b>	<b>1135</b>	<b>1201</b>	<b>1314</b>

- Passive lumbar in knit mesh back
- Seat mimics back design
- Black back is standard
- Loop arms
- Can be ordered with Blue or Rouge back
- Chrome five prong base with braking casters
- Seat is 19.5"W X 19"D X 16.5-20" H

OPTION	PRICE	CODE
Sliding Seat	85.00	SS
Adjustable Lumbar	25.00	Z

### 783 Guest Chair, Black Base

27" W X 26.25 D X 38" H St. Yardage: 1



Freight Class: 150  
Cubic Ft: 20  
Ship Weight: 37

Grade	1	2	3	4	5	6	7	8	9	10	L	LL
Zone 1	726	741	759	778	794	816	824	859	881	908	946	1082
Zone 2	737	752	770	790	806	828	836	872	894	922	960	1098
Zone 3	748	763	782	801	818	840	849	885	907	935	974	1114

- Passive lumbar in knit mesh back
- Seat mimics back design
- Black back is standard
- Loop arms
- Can be ordered with Blue or Rouge back
- Black cantilever base
- Seat: 19.5"W x 19"D x 18.5"H

**QS**

## Cirrus Fully Upholstered

### 741 Executive Swivel, Black Base

24-27.75" W X 32.5" D X 43.5-47.25" H St. Yardage: 3



Freight Class: 150  
Cubic Ft: 23  
Ship Weight: 52

Grade	1	2	3	4	5	6	7	8	9	10	L	LL
Zone 1	997	1038	1085	1138	1182	1242	1301	1360	1419	1494	1588	1734
Zone 2	1012	1054	1101	1155	1200	1261	1321	1380	1440	1516	1612	1760
Zone 3	1027	1069	1118	1172	1217	1279	1340	1401	1462	1539	1636	1786

- Passive lumbar in back
- Fully upholstered seat and back
- Black five prong base with braking casters
- 5-position synchro-tilt mechanism
- Height and width adjustable T-arms
- Seat: 19.5"W x 19"D x 16.5-20"H

OPTION	PRICE	CODE
Sliding Seat	85.00	SS
Adjustable Lumbar	25.00	Z

**QS**

### 741CB Executive Swivel, Chrome Base

24-27.75" W X 32.5" D X 43.5-47.25" H St. Yardage: 3



Freight Class: 150  
Cubic Ft: 23  
Ship Weight: 52

Grade	1	2	3	4	5	6	7	8	9	10	L	LL
Zone 1	1077	1118	1165	1218	1262	1322	1381	1440	1499	1574	1668	1814
Zone 2	1093	1135	1182	1236	1281	1342	1402	1462	1521	1598	1693	1841
Zone 3	1109	1152	1200	1255	1300	1362	1422	1483	1544	1621	1718	1868

- Passive lumbar in back
- Fully upholstered seat and back
- Chrome five prong base with braking casters
- 5-position synchro-tilt mechanism
- Height and width adjustable T-arms
- Seat: 19.5"W x 19"D x 16.5-20"H

OPTION	PRICE	CODE
Sliding Seat	85.00	SS
Adjustable Lumbar	25.00	Z

**QS**

### 747 Management Swivel, Black Base

24-27.75" W X 32.5" D X 37.5-41" H St. Yardage: 2



Freight Class: 150  
Cubic Ft: 20  
Ship Weight: 50

Grade	1	2	3	4	5	6	7	8	9	10	L	LL
Zone 1	973	1000	1032	1067	1097	1136	1176	1215	1255	1304	1367	1520
Zone 2	988	1015	1047	1083	1113	1153	1194	1233	1274	1324	1388	1543
Zone 3	1002	1030	1063	1099	1130	1170	1211	1251	1293	1343	1408	1566

- Passive lumbar in back
- Fully upholstered seat and back
- Black five prong base with braking casters
- 5-position synchro-tilt mechanism
- Height and width adjustable T-arms
- Seat: 19.5"W x 19"D x 16.5-20"H

OPTION	PRICE	CODE
Sliding Seat	85.00	SS
Adjustable Lumbar	25.00	Z

**QS**



**747CB Management Swivel, Chrome Base**

24-27.75" W X 32.5" D X 37.5-41" H St. Yardage: 2



Freight Class: 150  
Cubic Ft: 20  
Ship Weight: 50

Grade	1	2	3	4	5	6	7	8	9	10	L	LL
<b>Zone 1</b>	1052	1079	1111	1146	1176	1215	1255	1294	1334	1383	1446	1599
<b>Zone 2</b>	1068	1095	1128	1163	1194	1233	1274	1313	1354	1404	1468	1623
<b>Zone 3</b>	1084	1111	1144	1180	1211	1251	1293	1333	1374	1424	1489	1647

- Passive lumbar in back
- Fully upholstered seat and back
- Chrome five prong base with braking casters
- 5-position synchro-tilt mechanism
- Height and width adjustable T-arms
- Seat: 19.5"W x 19"D x 16.5-20"H

OPTION	PRICE	CODE
Sliding Seat	85.00	SS
Adjustable Lumbar	25.00	Z

**QS**

**748 Conference Chair, Black Base**

25.75" W X 32.5" D X 37.5-41" H St. Yardage: 2



Freight Class: 150  
Cubic Ft: 20  
Ship Weight: 54

Grade	1	2	3	4	5	6	7	8	9	10	L	LL
<b>Zone 1</b>	919	946	978	1013	1043	1082	1122	1161	1201	1250	1313	1466
<b>Zone 2</b>	933	960	993	1028	1059	1098	1139	1178	1219	1269	1333	1488
<b>Zone 3</b>	947	974	1007	1043	1074	1114	1156	1196	1237	1288	1352	1510

- Passive lumbar in back
- Fully upholstered seat and back
- Black five prong base with braking casters
- 5-position synchro-tilt mechanism
- Black loop-arms
- Seat: 19.5"W x 19"D x 16.5-20"H

OPTION	PRICE	CODE
Sliding Seat	85.00	SS
Adjustable Lumbar	25.00	Z

**QS**

**748CB Conference Chair, Chrome Base**

25.75" W X 32.5" D X 37.5-41" H St. Yardage: 2



Freight Class: 150  
Cubic Ft: 20  
Ship Weight: 54

Grade	1	2	3	4	5	6	7	8	9	10	L	LL
<b>Zone 1</b>	969	996	1028	1063	1103	1132	1172	1201	1251	1300	1363	1516
<b>Zone 2</b>	984	1011	1043	1079	1120	1149	1190	1219	1270	1320	1383	1539
<b>Zone 3</b>	998	1026	1059	1095	1136	1166	1207	1237	1289	1339	1404	1561

- Passive lumbar in back
- Fully upholstered seat and back
- Chrome five prong base with braking casters
- 5-position synchro-tilt mechanism
- Black loop-arms
- Seat: 19.5"W x 19"D x 16.5-20"H

OPTION	PRICE	CODE
Sliding Seat	85.00	SS
Adjustable Lumbar	25.00	Z

**QS**

**743 Guest Chair, Black Base**

25.75" W X 26.25" D X 38" H St. Yardage: 2



Freight Class: 150  
Cubic Ft: 20  
Ship Weight: 37

Grade	1	2	3	4	5	6	7	8	9	10	L	LL
<b>Zone 1</b>	776	803	835	870	900	939	979	1018	1058	1107	1170	1323
<b>Zone 2</b>	788	815	848	883	914	953	994	1033	1074	1124	1188	1343
<b>Zone 3</b>	799	827	860	896	927	967	1008	1049	1090	1140	1205	1363

- Passive lumbar in back
- Fully upholstered seat and back
- Black cantilever base
- Black loop-arms
- Seat: 19.5"W x 19"D x 18.5"H

**QS**

## Cirrus Cantilever Arms

### 761 Executive Chair, Cantilever Arms

24.75" W X 32.5" D X 43.5-47.25" H St. Yardage: 1



Freight Class: 150  
Cubic Ft: 23  
Ship Weight: 55

**QS**

Grade	1	2	3	4	5	6	7	8	9	10	L	LL
<b>Zone 1</b>	1002	1021	1040	1054	1070	1092	1100	1135	1157	1184	1241	1358
<b>Zone 2</b>	1017	1037	1056	1070	1086	1108	1117	1152	1174	1202	1260	1378
<b>Zone 3</b>	1032	1052	1071	1086	1102	1125	1133	1169	1192	1220	1278	1399

- Chrome base with black decorative inlays
- Chrome cantilever arms with decorative black inlays
- Passive lumbar support in knit mesh back
- Seat mimics back design
- Black back is standard
- Can be ordered with Blue or Rouge back
- Braking casters
- 5-position Synchro-tilt mechanism
- Seat: 19.5"W x 19"D x 16.5-20"H

OPTION	PRICE	CODE
Sliding Seat	85.00	SS
Adjustable Lumbar	25.00	Z

### 767 Management Chair, Cantilever Arms

24.75" W X 32.5" D X 37.5-41" H St. Yardage: 1



Freight Class: 150  
Cubic Ft: 20  
Ship Weight: 53

**QS**

Grade	1	2	3	4	5	6	7	8	9	10	L	LL
<b>Zone 1</b>	978	998	1017	1030	1046	1068	1076	1111	1133	1160	1218	1334
<b>Zone 2</b>	993	1012	1032	1045	1062	1084	1092	1128	1150	1177	1236	1354
<b>Zone 3</b>	1008	1027	1047	1061	1077	1100	1108	1144	1167	1195	1255	1374

- Chrome base with black decorative inlays
- Chrome cantilever arms with decorative black inlays
- Passive lumbar support in knit mesh back
- Seat mimics back design
- Black back is standard
- Can be ordered with Blue or Rouge back
- Braking casters
- 5-position Synchro-tilt mechanism
- Seat: 19.5"W x 19"D x 16.5-20"H

OPTION	PRICE	CODE
Sliding Seat	85.00	SS
Adjustable Lumbar	25.00	Z

### 763 Guest Chair, Cantilever Arms and Base

25" W X 26.25" D X 38" H St. Yardage: 1

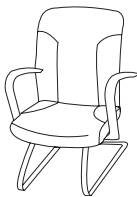

Freight Class: 150  
Cubic Ft: 18  
Ship Weight: 45

**QS**

Grade	1	2	3	4	5	6	7	8	9	10	L	LL
<b>Zone 1</b>	708	723	740	760	776	798	806	841	863	890	923	1064
<b>Zone 2</b>	718	733	751	771	788	810	818	854	876	903	937	1080
<b>Zone 3</b>	729	744	762	783	799	822	830	866	889	917	951	1096

- Chrome cantilever arms with decorative black inlays
- Black cantilevered tubular steel base
- Passive lumbar support in knit mesh back
- Seat mimics back design
- Black back is standard
- Can be ordered with Blue or Rouge back
- Braking casters
- 5-position Synchro-tilt mechanism
- Seat: 19.5"W x 19"D x 18.5"H

**Stay Up-to-Date with NexStep**

The **NexStep** collection of seating features the latest in seating materials and contemporary office styles. Featuring Air Grid mesh back material and breathable fabrics to help you keep your cool, NexStep seating includes executive, management, guest and a stacking arm chair.



**NexStep Details**

- **751s**— *Leather Executive chairs with metal base in gunmetal finish. Air Grid mesh back. Optional headrest*
- **752s**— *Management chairs with Air Grid mesh fabric back and black frame.*
- **759s**— *Guest chairs with thickly padded contour seat and Air Grid mesh back.*
- **730s**— *Metal frame arm chairs. Select from stacking or sledbase models*

**Additional Features & Options**

- *Optional fabric of your choice on seat*
- *Optional fabric of your choice on headrest—751 models only*
- *Upgrade to a dual density seat cushion for extra comfort*
- *Tilt-tension adjustment on swivel chairs*
- *Pneumatic seat-height adjustment on swivel chairs*
- *Ergonomically-shaped armrests*

**751 Executive & 752 Management**

**NexStep**

**733 4-Leg Stacking Armchair**



Freight Class: 250  
Cubic Ft: 15  
Ship Weight: 45

**QS**

24.5" W X 24" D X 32" H

St. Yardage: 1

Grade	1	2	3	4	5	6	7	8	9	10	L	LL
<b>Zone 1</b>	383	401	418	428	442	460	479	498	517	540	641	690
<b>Zone 2</b>	389	407	424	434	449	467	486	505	525	548	651	700
<b>Zone 3</b>	394	413	431	441	455	474	493	513	533	556	660	711

- Stacks 8 high
- Black metal frame
- Choose any upholstery
- Shipped 2 chairs per carton; price is per chair
- Seat: 18"W x 19"D x 19"H
- Seat height with casters is 21.5"
- Back height with casters is 34.5"

OPTION	PRICE	CODE
Casters	20.00	C
Single Pack Specifications: Freight Class: 300    Cubes: 15    Ship Wt: 28		

**734 Sled Base Armchair**



Freight Class: 300  
Cubic Ft: 15  
Ship Weight: 29

**QS**

24.5" W X 24" D X 32" H

St. Yardage: 1

Grade	1	2	3	4	5	6	7	8	9	10	L	LL
<b>Zone 1</b>	383	401	418	428	442	460	479	498	517	540	641	690
<b>Zone 2</b>	389	407	424	434	449	467	486	505	525	548	651	700
<b>Zone 3</b>	394	413	431	441	455	474	493	513	533	556	660	711

- Easy-slide sled base
- Black metal frame
- Choose any upholstery
- Not stackable
- Ships 1 chair per carton
- Seat: 18"W x 19"D x 19"H

### 751 Leather Executive Chair



- Mesh back
- Adjustable lumbar support
- Black leather seat and back trim
- 2-to-1 synchro tilt
- Pneumatic lift
- Height adjustable arms
- Black with gunmetal steel base
- Easy to assemble
- Can ship via FedEx Ground
- Maximum quantity for Quick Ship is 50
- Seat: 21"W x 20"D x 18.5-23"H

**QS** Freight Class: 100

### 752 Management Chair, Fabric Seat



- Mesh back with passive lumbar support
- 2-to-1 synchro tilt
- Pneumatic lift
- Height adjustable arms
- Black Poly Base
- Easy to assemble
- Can ship via FedEx Ground
- Maximum quantity for Quick Ship is 50
- Seat: 20"W x 20"D x 18.5-22.5"H

**QS** Freight Class: 100

### 759 Guest Chair



- Mesh back with built in lumbar support
- Breathable black fabric seat
- Fixed angled T-arms
- Black heavy duty tubular steel sled base
- Easy to assemble
- Can ship via FedEx Ground
- Maximum quantity for Quick Ship is 50
- Seat: 20"W x 20"D x 19.5"H

**QS** Freight Class: 100

### HR751 Black Headrest Only for 751 Chair

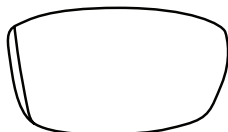

- Black mesh fabric
- Easy to attach
- Adjustable height
- Fits 751 chairs only
- Can ship via FedEx Ground

Freight Class: 70

### 757B Nesting Chair



- Black breathable ProGrid back
- Built-in lumbar support
- Black fabric padded seat
- Black finish on steel frame
- Dual wheel carpet casters
- Seat folds up for horizontal nesting
- Seat: 18"W x 19"D x 19.25"H

Freight Class: 150

		Zone Pricing	1	2	3
28" X 27.5" X 40-44" Cubic Ft: 7 Ship Weight: 49			<b>896</b>	<b>909</b>	<b>923</b>
<b>OPTION</b>	<b>PRICE</b>	<b>CODE</b>			
Assembly	48.00	A			
<b>CASTER</b>	<b>PRICE</b>	<b>CODE</b>			
Self-Locking Casters	85.00	S			
Braking Casters	30.00	B			
Hard-Floor Casters	19.00	H			
Glides	N/C	GL			
Assembled Specs: Ship Wt: 58 Cubes: 22					
26.5" X 26.5" X 38-42" Cubic Ft: 6 Ship Weight: 39			<b>622</b>	<b>631</b>	<b>641</b>
<b>OPTION</b>	<b>PRICE</b>	<b>CODE</b>			
Assembly	48.00	A			
<b>CASTER</b>	<b>PRICE</b>	<b>CODE</b>			
Self-Locking Casters	85.00	S			
Braking Casters	30.00	B			
Hard-Floor Casters	19.00	H			
Glides	N/C	GL			
Assembled Specs: Ship Wt: 49 Cubes: 22					
26.5" X 26.5" X 37.25" Cubic Ft: 6 Ship Weight: 38			<b>474</b>	<b>481</b>	<b>488</b>
<b>OPTION</b>	<b>PRICE</b>	<b>CODE</b>			
Assembly	48.00	A			
15.5" X 4" X 9" Cubic Ft: 1 Ship Weight: 4			<b>149</b>	<b>151</b>	<b>153</b>
24" X 23.5-24.5" X 36.5" Cubic Ft: 12 Ship Weight: 33			<b>409</b>	<b>415</b>	<b>421</b>

**751G Executive Chair**

28" W X 27.5" D X 40-44" H

St. Yardage: 1



Freight Class: 150  
Cubic Ft: 22  
Ship Weight: 58

Grade	1	2	3	4	5	6	7	8	9	10	L	LL
<b>Zone 1</b>	1040	1057	1071	1092	1108	1130	1138	1173	1195	1222		
<b>Zone 2</b>	1056	1073	1087	1108	1125	1147	1155	1191	1213	1240		
<b>Zone 3</b>	1071	1089	1103	1125	1141	1164	1172	1208	1231	1259		

- Mesh back
- Adjustable lumbar support
- 2-to-1 Synchro Tilt
- Pneumatic lift
- Height adjustable arms
- Extra thick dual density foam
- Black with gunmetal steel base
- Choose any HPFI fabric for seat
- Ships fully assembled truck only
- Seat: 21"W x 20"D x 18.5-23"H

CASTER	PRICE	CODE
Self-Locking Casters	85.00	S
Braking Casters	30.00	B
Hard-Floor Casters	19.00	H
Glides	N/C	GL

**QS**

**751GHR Executive Chair, Fabric Seat & Headrest**

28" W X 27.5" D X 49-53" H

St. Yardage: 1



Freight Class: 150  
Cubic Ft: 26  
Ship Weight: 72

Grade	1	2	3	4	5	6	7	8	9	10	L	LL
<b>Zone 1</b>	1138	1153	1170	1185	1200	1220	1239	1259	1279	1304		
<b>Zone 2</b>	1155	1170	1188	1203	1218	1238	1258	1278	1298	1323		
<b>Zone 3</b>	1172	1187	1205	1220	1236	1256	1276	1297	1317	1343		

- Mesh back
- Adjustable lumbar support
- 2-to-1 Synchro Tilt
- Pneumatic lift
- Height adjustable arms
- Includes upholstered headrest
- Choose any fabric for seat/headrest
- Black with gunmetal steel base
- Extra thick dual density foam
- Ships fully assembled truck only
- Seat: 21"W x 20"D x 18.5-23"H

CASTER	PRICE	CODE
Self-Locking Casters	85.00	S
Braking Casters	30.00	B
Hard-Floor Casters	19.00	H
Glides	N/C	GL

**QS**

**752G Management Chair**

26.5" W X 26.5" D X 38-42" H

St. Yardage: 1



Freight Class: 150  
Cubic Ft: 22  
Ship Weight: 49

Grade	1	2	3	4	5	6	7	8	9	10	L	LL
<b>Zone 1</b>	700	715	733	752	768	790	798	833	855	882		
<b>Zone 2</b>	711	726	744	763	780	802	810	845	868	895		
<b>Zone 3</b>	721	736	755	775	791	814	822	858	881	908		

- Mesh back with passive lumbar support
- 2-to-1 Synchro Tilt
- Height adjustable arms
- Black poly base
- Choose any HPFI fabric for seat
- Extra thick dual density foam
- Ships fully assembled truck only
- Seat: 20"W x 20"D x 18.5-22.5"H

CASTER	PRICE	CODE
Self-Locking Casters	85.00	S
Braking Casters	30.00	B
Hard-Floor Casters	19.00	H
Glides	N/C	GL

**QS**

**759G Guest Chair, Fabric Seat**

26.5" W X 26.5" D X 37.25" H

St. Yardage: 1



Freight Class: 150  
Cubic Ft: 15  
Ship Weight: 40

Grade	1	2	3	4	5	6	7	8	9	10	L	LL
<b>Zone 1</b>	509	527	541	561	577	599	607	642	664	691		
<b>Zone 2</b>	517	535	549	569	586	608	616	652	674	701		
<b>Zone 3</b>	524	543	557	578	594	617	625	661	684	712		

- Mesh back with passive lumbar support
- Breathable black fabric seat
- Fixed angled T-arms
- Black heavy duty tubular steel sled base
- Easy to assemble
- Choose any HPFI fabric for seat
- Extra thick dual density foam
- Maximum quantity for Quick Ship is 50
- Seat: 20"W x 20"D x 19.5"H
- Ships fully assembled truck only

**QS**

### HR5751G Fabric Headrest for 751 Chair

15.5" W X 4" D X 9" H

St. Yardage: .25

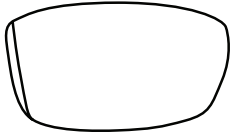

Freight Class: 70

Cubic Ft: 1

Ship Weight: 4

Grade	1	2	3	4	5	6	7	8	9	10	L	LL
<b>Zone 1</b>	174	178	183	187	191	196	199	207	213	220		
<b>Zone 2</b>	177	181	186	190	194	199	202	210	216	223		
<b>Zone 3</b>	179	183	188	193	197	202	205	213	219	227		

- Choose any HPFI fabric for seat
- Easy to attach
- Fits 751 chairs only
- Adjustable height
- Can ship via FedEx Ground

**QS**

### 757 Nesting Chair

24" W X 24.5" D X 36.5" H

St. Yardage: 1



Freight Class: 150

Cubic Ft: 12

Ship Weight: 33

Grade	1	2	3	4	5	6	7	8	9	10	L	LL
<b>Zone 1</b>	460	475	490	507	522	542	561	581	601	626	662	767
<b>Zone 2</b>	467	482	497	515	530	550	569	590	610	635	672	779
<b>Zone 3</b>	474	489	505	522	538	558	578	598	619	645	682	790

- Black breathable ProGrid back
- Built-in lumbar support
- Choose any fabric for seat
- Black finish on steel frame
- Black urethane arms
- Dual wheel carpet casters
- Seat folds up for horizontal nesting
- Seat: 18"W x 19"D x 19.25"H

**QS**



**FINISH SELECTION**

ROUGE MAHOGANY **RM** | WINDSOR CHERRY **WC** | BLACK **BLK** | MOAB **MOB** |  
 HONEY CHERRY **HCY** | PEARWOOD **PW** | MAHOGANY **MAH** | ASPEN **AP** |  
 ESPRESSO **ESP** | CLASSIC CHERRY **CCY** | WALNUT **WAL** |

SIN 711-18

# BRAVADO BIG & TALL

BIG & TALL

**Bravado: Big & Tall**

**Bravado** is built for executive comfort. With two models and styles— task chair or executive chair— **Bravado Big & Tall** will be a harmonious addition to traditional, transitional or contemporary environments.

**Warranty**

- 15 years for normal use
- 5 years for 24/7 use (186 task only)

**186 Task Details**

- Rated to 500 lbs.
- Built for 24/7 use
- Pneumatic seat-height adjustment
- Knee-tilt control standard
- 3" dual-wheel carpet casters
- Overside intensive use base

**181 Executive Traditional Details**

- Rated to 500 lbs.
- Pneumatic seat-height adjustment
- Knee-tilt control standard
- 3" dual-wheel carpet casters
- Optional Nailhead Trim
- Welt Trim on arms, seat and back
- Oversize steel base with wood cap



**Bravado Traditional Executive 181**



**Bravado Contemporary Task 186**

## Bravado Big & Tall

**181 Traditional Big & Tall Executive Swivel**

34.5" W X 27.5" D X 49-51" H St. Yardage: 6



Freight Class: 150  
 Cubic Ft: 35  
 Ship Weight: 96

Grade	1	2	3	4	5	6	7	8	9	10	L	LL
<b>Zone 1</b>	2335	2423	2509	2617	2706	2824	2943	3061	3180	3328	3526	3610
<b>Zone 2</b>	2370	2459	2547	2656	2747	2866	2987	3107	3228	3378	3579	3664
<b>Zone 3</b>	2405	2496	2584	2696	2787	2909	3031	3153	3275	3428	3632	3718

- Rated to 500 lbs.
- Oversize 28" 5-prong steel base with traditional wood caps
- 3" dual-wheel carpet casters
- Welt trim on arms, seat and back
- Pneumatic seat-height adjustment
- 15 year warranty
- Knee tilt control with tilt lock standard
- Seat: 21.5"W x 21.5"D x 22.5-26.25"H

OPTION	PRICE	CODE
Softer Seat Foam-Chair	16.00	SF
Nailhead Trim	55.00	NH

**QS**

**186 Big & Tall High Back Executive Swivel**

32" W X 28" D X 47-52" H St. Yardage: 4.75



Freight Class: 150  
 Cubic Ft: 34  
 Ship Weight: 90

Grade	1	2	3	4	5	6	7	8	9	10	L	LL
<b>Zone 1</b>	1984	2048	2112	2195	2262	2351	2440	2529	2618	2729	2851	2940
<b>Zone 2</b>	2014	2079	2144	2228	2296	2386	2477	2567	2657	2770	2894	2984
<b>Zone 3</b>	2044	2109	2175	2261	2330	2422	2513	2605	2697	2811	2937	3028

- Max. overall 36.5" x 28 x 52"
- 26" High Back
- Synchro knee tilt control with tilt lock
- Adjustable T-arms (3" H and 2" W each arm)
- Rated to 500 lbs.
- 60mm heavy-duty casters
- Oversized 28" intensive use five-prong base
- Warranted 15 years (5 years for 24/7 use)
- Fully upholstered back standard
- Seat: 24"W x 21"D x 20.5-25.5"H
- Between arms 27-31.5" at arm base, 21-25.5" at arm caps

OPTION	PRICE	CODE
Softer Seat Foam-Chair	16.00	SF

**QS**

# COUGAR SIN 711-18

FAST CATS ERGONOMIC

## Go Fast with Fast Cats: Cougar

Elegant arched back sets **Cougar** apart from the pack. Cougar is available in executive and management models. Multifunction mechanism control adjusts position of chair components for active users.

### Cougar Features

- Adjustable seat height, 4" range-Pneumatic
- Adjustable back height, 4" range — 6 positions
- Adjustable arm height, 3" range — 6 positions
- Seats slider adjusts seat depth to 2"
- Adjustable arm width, 4" range — 2" per arm
- Swivel/tilt with tilt lock
- Back angle adjustment
- Forward seat tilt and tilt lock

### Back Height Choices

- Executive 24.5" high back
- Management 22" high back

### Cougar Mechanism

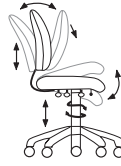

**Multifunction Control** adjusts position of chair components for active users.

- Swivel, tilt and tilt lock
- Tilt tension adjustment
- Back angle adjustment
- Forward seat tilt adjustment with forward tilt lock



Management 627

Executive 621

### Specifications

#### Overall

- Width 27"-31", Depth 25"-27"
- Height 37"-41" (Mgmt)
- Height 39"-43" (Exec)

#### Seat

- Width 20.75", Depth 20.25"
- Thickness 4"

#### Back

- Width 20" (Exec) 19" (Mgmt)
- Height 24-1/2" (Exec) 22" (Mgmt)
- Thickness 4"

#### Other

- Seat Height 19"-23"
- Arm Height from seat 7"-10"

## Cougar

### 621 Executive Swivel Chair

27" W X 25.5" D X 39-43" H

St. Yardage: 2.75



Freight Class: 150

Cubic Ft: 23

Ship Weight: 66

Grade	1	2	3	4	5	6	7	8	9	10	L	LL
Zone 1	828	859	891	953	992	1044	1097	1149	1202	1267	1392	1487
Zone 2	840	872	904	967	1007	1060	1113	1166	1220	1286	1413	1509
Zone 3	853	885	918	982	1022	1075	1130	1183	1238	1305	1434	1532

- Multifunction mechanism
- Executive height back
- Standard seat slider travels 2"
- Ships fully assembled
- Nylon base with metal understructure
- Seat: 20.75"W x 20.25"D x 19-23"H

OPTION	PRICE	CODE
Upholstered Back	59.00	UB
CASTER	PRICE	CODE
Self-Locking Casters	85.00	S
Braking Casters	30.00	B
Hard-Floor Casters	19.00	H
Glides	N/C	GL

### QS

### 627 Management Swivel Chair

27" W X 25.5" D X 37-41" H

St. Yardage: 2.5



Freight Class: 150

Cubic Ft: 21

Ship Weight: 64

Grade	1	2	3	4	5	6	7	8	9	10	L	LL
Zone 1	769	801	832	894	933	985	1038	1090	1143	1208	1333	1428
Zone 2	781	813	844	907	947	1000	1054	1106	1160	1226	1353	1449
Zone 3	792	825	857	921	961	1015	1069	1123	1177	1244	1373	1471

- Multifunction mechanism
- Management height back
- Standard seat slider travels 2"
- Ships fully assembled
- Nylon base with metal understructure
- Seat: 20.75"W x 20.25"D x 19-23"H

OPTION	PRICE	CODE
Upholstered Back	59.00	UB
CASTER	PRICE	CODE
Self-Locking Casters	85.00	S
Braking Casters	30.00	B
Hard-Floor Casters	19.00	H
Glides	N/C	GL

### QS

**Go Fast with Fast Cats: Puma**

Elegant arched back sets **Puma** apart from the pack. Puma is available in executive and management models. Syncrotilt mechanism and adjustable components for active users.

**Puma Features**

- Adjustable seat height, 4" range-Pneumatic
- Adjustable back height, 4" range — 6 positions
- Adjustable arm height, 3" range — 6 positions
- Adjustable arm width, 4" range — 2" per arm



**Back Height Choices**

- Executive 24.5" high back
- Management 22" high back

**Syncrotilt Mechanism**

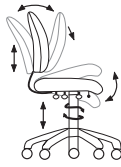

- Swivel, tilt and tilt lock
- 360° Swivel Pneumatic lift
- 2:1 ratio back-to-seat angle adjustment as you recline

**Specifications**

**Overall**

- Width 27"-31", Depth 25"-27"
- Height 37"-41" (Mgmt)
- Height 39"-43" (Exec)

**Seat**

- Width 20.75", Depth 20.25"
- Thickness 4"

**Back**

- Width 20" (Exec) 19" (Mgmt)
- Height 24-1/2" (Exec) 22" (Mgmt)
- Thickness 4"

**Other**

- Seat Height 19"-23"
- Arm Height from seat 7"-10"

**Puma**

**631 Executive Swivel Chair, Synchro Tilt**

27" W X 25.5" D X 39-43" H St. Yardage: 2.75



Freight Class: 150  
Cubic Ft: 23  
Ship Weight: 66

Grade	1	2	3	4	5	6	7	8	9	10	L	LL
Zone 1	728	758	789	812	850	889	941	992	1044	1095	1155	1282
Zone 2	740	771	802	824	863	902	955	1007	1060	1111	1172	1301
Zone 3	752	783	815	836	876	916	969	1022	1075	1128	1190	1320

- Synchro tilt mechanism
- 2:1 ratio back-to-seat angle adjustment as you recline
- Pneumatic seat height adjustment
- Swivel/tilt with tilt lock
- Adjustable back height
- Height and width adjustable T-arms
- Black nylon base with metal understructure
- Ships fully assembled
- Seat: 20.75"W x 20.25"D x 19-23"H

OPTION	PRICE	CODE
Upholstered Back	59.00	UB
CASTER	PRICE	CODE
Self-Locking Casters	85.00	S
Braking Casters	30.00	B
Hard-Floor Casters	19.00	H
Glides	N/C	GL

**QS**

**637 Management Swivel, Synchro Tilt**

27" W X 25.5" D X 37-41" H St. Yardage: 2.5



Freight Class: 150  
Cubic Ft: 21  
Ship Weight: 64

Grade	1	2	3	4	5	6	7	8	9	10	L	LL
Zone 1	670	701	732	754	792	831	883	934	986	1037	1097	1344
Zone 2	681	713	744	765	804	843	896	948	1001	1053	1113	1364
Zone 3	693	724	756	777	816	856	909	962	1016	1068	1130	1384

- Synchro tilt mechanism
- 2:1 ratio back-to-seat angle adjustment as you recline
- Pneumatic seat height adjustment
- Swivel/tilt with tilt lock
- Adjustable back height
- Height and width adjustable T-arms
- Black nylon base with metal understructure
- Ships fully assembled
- Seat: 20.75"W x 20.25"D x 19-23"H

OPTION	PRICE	CODE
Upholstered Back	59.00	UB
CASTER	PRICE	CODE
Self-Locking Casters	85.00	S
Braking Casters	30.00	B
Hard-Floor Casters	19.00	H
Glides	N/C	GL

**QS**

# PANTHER SIN 711-18

FAST CATS ERGONOMIC

## Go Fast with Fast Cats: Panther

Go on the prowl with **Panther**. With numerous adjustments for back, seat and arms, Panther can be customized for maximum comfort and efficiency.

### Panther Features

- Adjustable seat height, 5" range-Pneumatic
- Adjustable back height, 4" range — 6 positions
- Adjustable arm height, 2.5" range — 8 positions
- Adjustable arm width, 4" range — 2" per arm
- Tilt tension adjustment
- Curved loop arm design
- Contoured, molded foam
- Extra-wide seats & bases

### Back Height Choices

- Executive 24" high back
- Management 20" high back

## Mechanism Choices

**Full Function (FM)** Highest level of control for active users.

- Swivel, tilt and tilt lock
- Tilt tension adjustment
- Back angle adjustment
- Forward seat
- Tilt adjustment

**Synchro Tilt (YM)** Passive ergonomic support for users who prefer fewer levers.

- Swivel, tilt and tilt lock
- Tilt tension adjustment
- 2:1 ratio back-to-seat-angle adjustment as you recline

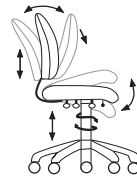

Full-Feature Mechanism

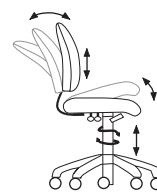

Synchro-Tilt Mechanism

## Specifications

### Overall

- Width 26"-30", Depth 24"

### Seat

- Width 21", Depth 20", Thickness 3"

### Back

- Width 19" (Exec) 17" (Mgmt)
- Height 24" (Exec) 20" (Mgmt)
- Thickness 3"

### Other

- Seat Height 18"-23"
- Arm Height from seat 6"-8.5"
- Arm Height from floor 25" (Measured with seat/arms in lowest position)



331 Panther Executive

**Please Note: If CAL 133 specification is desired, call HPFI customer service for more information.**

## Panther

**331FM30AL Executive Back with Full Feature Mechanism** 26" W X 24" D X 38-43" H St. Yardage: 2.8



Grade	1	2	3	4	5	6	7	8	9	10	L	LL
Zone 1	973	1029	1074	1118	1163	1224	1248	1346	1407	1483	1582	1727
Zone 2	988	1044	1090	1135	1180	1242	1267	1366	1428	1505	1606	1753
Zone 3	1002	1060	1106	1152	1198	1261	1285	1386	1449	1527	1629	1779

- 24" high back
- Full-feature mechanism
- Adjustable loop arms
- Can ship via ground service
- Requires assembly
- Seat: 21"W x 20"D x 18-23"H

OPTION	PRICE	CODE
Metal Base	59.00	MB
Chrome Base	59.00	CB
Upholstered Back	59.00	UB
Assembly	48.00	A
Adjustable T Arm (Replace AL with AT)	N/C	AT
Sliding Seat	85.00	SS
CASTER	PRICE	CODE
Self-Locking Casters	85.00	S
Braking Casters	30.00	B
Hard-Floor Casters	19.00	H
Glides	N/C	GL

Freight Class: 100

Cubic Ft: 11

Ship Weight: 54

**QS**

**331YM30AL Executive Back with Synchro Tilt Mechanism** 26" W X 24" D X 38-43" H St. Yardage: 2.8



Grade	1	2	3	4	5	6	7	8	9	10	L	LL
<b>Zone 1</b>	<b>909</b>	<b>966</b>	<b>1011</b>	<b>1054</b>	<b>1099</b>	<b>1160</b>	<b>1184</b>	<b>1282</b>	<b>1343</b>	<b>1419</b>	<b>1518</b>	<b>1766</b>
<b>Zone 2</b>	<b>923</b>	<b>980</b>	<b>1026</b>	<b>1070</b>	<b>1115</b>	<b>1177</b>	<b>1202</b>	<b>1301</b>	<b>1363</b>	<b>1440</b>	<b>1544</b>	<b>1792</b>
<b>Zone 3</b>	<b>936</b>	<b>995</b>	<b>1041</b>	<b>1086</b>	<b>1132</b>	<b>1195</b>	<b>1220</b>	<b>1320</b>	<b>1383</b>	<b>1462</b>	<b>1564</b>	<b>1819</b>

- 24" high back
- Synchro tilt mechanism
- Adjustable loop arms
- Can ship via ground service
- Requires assembly
- Seat: 21"W x 20"D x 18-23"H

OPTION	PRICE	CODE
Metal Base	59.00	MB
Chrome Base	59.00	CB
Upholstered Back	59.00	UB
Assembly	48.00	A
Adjustable T Arm (Replace AL with AT)	N/C	AT
CASTER	PRICE	CODE
Self-Locking Casters	85.00	S
Braking Casters	30.00	B
Hard-Floor Casters	19.00	H
Glides	N/C	GL

Freight Class: 100  
Cubic Ft: 11  
Ship Weight: 55

**QS**

**330FM30AL Management Back with Full Feature Mechanism** 26" W X 24" D X 37-43" H St. Yardage: 2



Grade	1	2	3	4	5	6	7	8	9	10	L	LL
<b>Zone 1</b>	<b>959</b>	<b>1016</b>	<b>1059</b>	<b>1088</b>	<b>1129</b>	<b>1183</b>	<b>1204</b>	<b>1292</b>	<b>1346</b>	<b>1414</b>	<b>1527</b>	<b>1749</b>
<b>Zone 2</b>	<b>973</b>	<b>1031</b>	<b>1075</b>	<b>1104</b>	<b>1146</b>	<b>1201</b>	<b>1222</b>	<b>1311</b>	<b>1366</b>	<b>1435</b>	<b>1550</b>	<b>1775</b>
<b>Zone 3</b>	<b>988</b>	<b>1046</b>	<b>1091</b>	<b>1121</b>	<b>1163</b>	<b>1218</b>	<b>1240</b>	<b>1331</b>	<b>1386</b>	<b>1456</b>	<b>1573</b>	<b>1810</b>

- 20" high back
- Full-feature mechanism
- Adjustable loop arms
- Can ship via ground service
- Requires assembly
- Seat: 21"W x 20"D x 18-23"H

OPTION	PRICE	CODE
Metal Base	59.00	MB
Chrome Base	59.00	CB
Upholstered Back	59.00	UB
Assembly	48.00	A
Adjustable T Arm (Replace AL with AT)	N/C	AT
Sliding Seat	85.00	SS
CASTER	PRICE	CODE
Self-Locking Casters	85.00	S
Braking Casters	30.00	B
Hard-Floor Casters	19.00	H
Glides	N/C	GL

Freight Class: 100  
Cubic Ft: 11  
Ship Weight: 53

**QS**

**330YM30AL Management Back with Synchro Tilt Mechanism** 26" W X 24" D X 37-43" H St. Yardage: 2



Grade	1	2	3	4	5	6	7	8	9	10	L	LL
<b>Zone 1</b>	<b>896</b>	<b>952</b>	<b>995</b>	<b>1025</b>	<b>1066</b>	<b>1120</b>	<b>1141</b>	<b>1229</b>	<b>1283</b>	<b>1351</b>	<b>1465</b>	<b>1686</b>
<b>Zone 2</b>	<b>909</b>	<b>966</b>	<b>1010</b>	<b>1040</b>	<b>1082</b>	<b>1137</b>	<b>1158</b>	<b>1247</b>	<b>1302</b>	<b>1371</b>	<b>1487</b>	<b>1711</b>
<b>Zone 3</b>	<b>923</b>	<b>981</b>	<b>1025</b>	<b>1056</b>	<b>1098</b>	<b>1154</b>	<b>1175</b>	<b>1266</b>	<b>1321</b>	<b>1392</b>	<b>1509</b>	<b>1737</b>

- 20" high back
- Synchro tilt mechanism
- Adjustable loop arms
- Can ship via ground service
- Requires assembly
- Seat: 21"W x 20"D x 18-23"H

OPTION	PRICE	CODE
Metal Base	59.00	MB
Chrome Base	59.00	CB
Upholstered Back	59.00	UB
Assembly	48.00	A
Adjustable T Arm (Replace AL with AT)	N/C	AT
CASTER	PRICE	CODE
Self-Locking Casters	85.00	S
Braking Casters	30.00	B
Hard-Floor Casters	19.00	H
Glides	N/C	GL

Freight Class: 100  
Cubic Ft: 11  
Ship Weight: 54

**QS**

# JAGUAR SIN 711-18

FAST CATS ERGONOMIC

## Go Fast with Fast Cats: Jaguar

Stay on task with **Jaguar**. Sleek and sturdy, these task chairs are ready to go anywhere with adjustable seat and back, black nylon base, and T-arm design.

### Jaguar Features

- Adjustable seat height, 5" range-Pneumatic
- Adjustable back depth, 3" range
- Contoured, molded foam
- Extra-wide seats & bases

### Back Height Choices

- Highback 20" high
- Midback 16" high

### Arm Choices

- Adjustable T Arms
- 3" height-adjustment
- 4" width adjustment - 2" per arm
- Fixed T Arms
- Armless

**Please Note: If CAL 133 specification is desired, call HPFI customer service for more information.**

## Mechanism Choices

### Basic Mechanism (BM)

- 360° Swivel (No Tilt)
- Pneumatic lift
- Adjustable back depth

### Upgrade Mechanism (SM)

- 360° Swivel
- Seat/Back tilts as one unit
- Pneumatic lift
- Adjustable back depth
- Tilt tension control

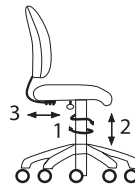

Basic Mechanism

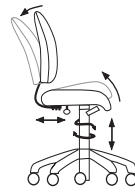

Upgrade Mechanism

## Specifications

### Overall

- Depth 24", Height 35"-40"

### Seat

- Width 21", Depth 20", Thickness 3"

### Back

- Width 18"
- Height 20" (High) 16" (Med)
- Thickness 3"

### Other

- Seat Height 18"-23"
- Arm Height from seat 6"-8"
- Arm Height from floor 25" (Measured with seat/arms in lowest position)



320 Jaguar Midback

## Jaguar Highback - Upgrade Mechanism

321SM30AT Highback - Adjustable T-arms

26" W X 24" D X 37-42" H

St. Yardage: 2



Grade	1	2	3	4	5	6	7	8	9	10	L	LL
Zone 1	738	795	837	867	908	962	983	1071	1125	1193	1253	1422
Zone 2	749	807	850	880	922	976	998	1087	1142	1211	1272	1443
Zone 3	760	819	862	893	935	991	1012	1103	1159	1229	1291	1465

- 20" high back
- Adjustable T-arms
- Can ship via ground service
- Requires assembly
- Seat: 21"W x 20"D x 18-23"H

OPTION	PRICE	CODE
Metal Base	59.00	MB
Chrome Base	59.00	CB
Adjustable Back Height	59.00	AB
Upholstered Back	59.00	UB
Assembly	48.00	A

CASTER	PRICE	CODE
Self-Locking Casters	85.00	S
Braking Casters	30.00	B
Hard-Floor Casters	19.00	H
Glides	N/C	GL

Freight Class: 100

Cubic Ft: 11

Ship Weight: 55

QS



**321SM30T Highback - Fixed T-arms**

25" W X 24" D X 37-42" H

St. Yardage: 2



Grade	1	2	3	4	5	6	7	8	9	10	L	LL
<b>Zone 1</b>	<b>706</b>	<b>762</b>	<b>806</b>	<b>835</b>	<b>876</b>	<b>930</b>	<b>951</b>	<b>1039</b>	<b>1093</b>	<b>1161</b>	<b>1221</b>	<b>1446</b>
<b>Zone 2</b>	<b>717</b>	<b>773</b>	<b>818</b>	<b>848</b>	<b>889</b>	<b>944</b>	<b>965</b>	<b>1055</b>	<b>1109</b>	<b>1178</b>	<b>1239</b>	<b>1468</b>
<b>Zone 3</b>	<b>727</b>	<b>785</b>	<b>830</b>	<b>860</b>	<b>902</b>	<b>958</b>	<b>980</b>	<b>1070</b>	<b>1126</b>	<b>1196</b>	<b>1258</b>	<b>1489</b>

- 20" high back
- Fixed T-arms
- Can ship via ground service
- Requires assembly
- Seat: 21"W x 20"D x 18-23"H

OPTION	PRICE	CODE
Metal Base	59.00	MB
Chrome Base	59.00	CB
Adjustable Back Height	59.00	AB
Upholstered Back	59.00	UB
Assembly	48.00	A
CASTER	PRICE	CODE
Self-Locking Casters	85.00	S
Braking Casters	30.00	B
Hard-Floor Casters	19.00	H
Glides	N/C	GL

Freight Class: 100

Cubic Ft: 11

Ship Weight: 54

**QS**

**321SM Highback - Armless**

21" W X 24" D X 37-42" H

St. Yardage: 2



Grade	1	2	3	4	5	6	7	8	9	10	L	LL
<b>Zone 1</b>	<b>610</b>	<b>667</b>	<b>710</b>	<b>739</b>	<b>780</b>	<b>834</b>	<b>855</b>	<b>943</b>	<b>997</b>	<b>1065</b>	<b>1125</b>	<b>1300</b>
<b>Zone 2</b>	<b>619</b>	<b>677</b>	<b>721</b>	<b>750</b>	<b>792</b>	<b>847</b>	<b>868</b>	<b>957</b>	<b>1012</b>	<b>1081</b>	<b>1142</b>	<b>1320</b>
<b>Zone 3</b>	<b>628</b>	<b>687</b>	<b>731</b>	<b>761</b>	<b>803</b>	<b>859</b>	<b>881</b>	<b>971</b>	<b>1027</b>	<b>1097</b>	<b>1159</b>	<b>1339</b>

- 20" high back
- Armless
- Can ship via ground service
- Requires assembly
- Seat: 21"W x 20"D x 18-23"H

OPTION	PRICE	CODE
Metal Base	59.00	MB
Chrome Base	59.00	CB
Adjustable Back Height	59.00	AB
Upholstered Back	59.00	UB
Assembly	48.00	A
CASTER	PRICE	CODE
Self-Locking Casters	85.00	S
Braking Casters	30.00	B
Hard-Floor Casters	19.00	H
Glides	N/C	GL

Freight Class: 100

Cubic Ft: 11

Ship Weight: 49

**QS**

**Jaguar Highback - Basic Mechanism**

**321BM30AT Highback - Adjustable T-arms**

26" W X 24" D X 37-42" H

St. Yardage: 2



Grade	1	2	3	4	5	6	7	8	9	10	L	LL
<b>Zone 1</b>	<b>706</b>	<b>762</b>	<b>806</b>	<b>835</b>	<b>876</b>	<b>930</b>	<b>951</b>	<b>1039</b>	<b>1093</b>	<b>1161</b>	<b>1221</b>	<b>1446</b>
<b>Zone 2</b>	<b>717</b>	<b>773</b>	<b>818</b>	<b>848</b>	<b>889</b>	<b>944</b>	<b>965</b>	<b>1055</b>	<b>1109</b>	<b>1178</b>	<b>1239</b>	<b>1468</b>
<b>Zone 3</b>	<b>727</b>	<b>785</b>	<b>830</b>	<b>860</b>	<b>902</b>	<b>958</b>	<b>980</b>	<b>1070</b>	<b>1126</b>	<b>1196</b>	<b>1258</b>	<b>1489</b>

- 20" high back
- Adjustable T-arms
- Can ship via ground service
- Requires assembly
- Seat: 21"W x 20"D x 18-23"H

OPTION	PRICE	CODE
Metal Base	59.00	MB
Chrome Base	59.00	CB
Adjustable Back Height	59.00	AB
Full Feature Mechanism (Replace BM with FM)	139.00	FM
Upholstered Back	59.00	UB
Assembly	48.00	A
CASTER	PRICE	CODE
Self-Locking Casters	85.00	S
Braking Casters	30.00	B
Hard-Floor Casters	19.00	H
Glides	N/C	GL

Freight Class: 100

Cubic Ft: 11

Ship Weight: 48

**QS**

# JAGUAR SIN 711-18

FAST CATS ERGONOMIC

## 321BM30T Highback - Fixed T-arms

25" W X 24" D X 37-42" H

St. Yardage: 2



Grade	1	2	3	4	5	6	7	8	9	10	L	LL
<b>Zone 1</b>	<b>674</b>	<b>731</b>	<b>774</b>	<b>803</b>	<b>844</b>	<b>898</b>	<b>919</b>	<b>1007</b>	<b>1061</b>	<b>1129</b>	<b>1189</b>	<b>1358</b>
<b>Zone 2</b>	<b>684</b>	<b>742</b>	<b>786</b>	<b>815</b>	<b>857</b>	<b>911</b>	<b>933</b>	<b>1022</b>	<b>1077</b>	<b>1146</b>	<b>1207</b>	<b>1378</b>
<b>Zone 3</b>	<b>694</b>	<b>753</b>	<b>797</b>	<b>827</b>	<b>869</b>	<b>925</b>	<b>947</b>	<b>1037</b>	<b>1093</b>	<b>1163</b>	<b>1225</b>	<b>1399</b>

- 20" high back
- Fixed T-arms
- Can ship via ground service
- Requires assembly
- Seat: 21"W x 20"D x 18-23"H

OPTION	PRICE	CODE
Metal Base	59.00	MB
Chrome Base	59.00	CB
Adjustable Back Height	59.00	AB
Full Feature Mechanism (Replace BM with FM)	139.00	FM
Upholstered Back	59.00	UB
Assembly	48.00	A
CASTER	PRICE	CODE
Self-Locking Casters	85.00	S
Braking Casters	30.00	B
Hard-Floor Casters	19.00	H
Glides	N/C	GL

Freight Class: 100

Cubic Ft: 11

Ship Weight: 47

**QS**

## 321BM Highback - Armless

21" W X 24" D X 37-42" H

St. Yardage: 2



Grade	1	2	3	4	5	6	7	8	9	10	L	LL
<b>Zone 1</b>	<b>578</b>	<b>634</b>	<b>679</b>	<b>707</b>	<b>748</b>	<b>802</b>	<b>823</b>	<b>881</b>	<b>965</b>	<b>1033</b>	<b>1094</b>	<b>1268</b>
<b>Zone 2</b>	<b>587</b>	<b>644</b>	<b>689</b>	<b>718</b>	<b>759</b>	<b>814</b>	<b>835</b>	<b>894</b>	<b>979</b>	<b>1048</b>	<b>1110</b>	<b>1287</b>
<b>Zone 3</b>	<b>595</b>	<b>653</b>	<b>699</b>	<b>728</b>	<b>770</b>	<b>826</b>	<b>848</b>	<b>907</b>	<b>994</b>	<b>1064</b>	<b>1127</b>	<b>1306</b>

- 20" high back
- Armless
- Can ship via ground service
- Requires assembly
- Seat: 21"W x 20"D x 18-23"H

OPTION	PRICE	CODE
Metal Base	59.00	MB
Chrome Base	59.00	CB
Adjustable Back Height	59.00	AB
Full Feature Mechanism (Replace BM with FM)	139.00	FM
Upholstered Back	59.00	UB
Assembly	48.00	A
CASTER	PRICE	CODE
Self-Locking Casters	85.00	S
Braking Casters	30.00	B
Hard-Floor Casters	19.00	H
Glides	N/C	GL

Freight Class: 100

Cubic Ft: 11

Ship Weight: 42

**QS**

## Jaguar Midback - Upgrade Mechanism

### 320SM30AT Midback - Adjustable T-arms

26" W X 24" D X 35-40" H

St. Yardage: 2



Grade	1	2	3	4	5	6	7	8	9	10	L	LL
<b>Zone 1</b>	<b>696</b>	<b>753</b>	<b>797</b>	<b>825</b>	<b>866</b>	<b>920</b>	<b>941</b>	<b>1029</b>	<b>1083</b>	<b>1151</b>	<b>1199</b>	<b>1380</b>
<b>Zone 2</b>	<b>706</b>	<b>764</b>	<b>809</b>	<b>837</b>	<b>879</b>	<b>934</b>	<b>955</b>	<b>1044</b>	<b>1099</b>	<b>1168</b>	<b>1217</b>	<b>1401</b>
<b>Zone 3</b>	<b>717</b>	<b>776</b>	<b>821</b>	<b>850</b>	<b>892</b>	<b>948</b>	<b>969</b>	<b>1060</b>	<b>1115</b>	<b>1186</b>	<b>1235</b>	<b>1421</b>

- 16" high back
- Adjustable T-arms
- Can ship via ground service
- Requires assembly
- Seat: 21"W x 20"D x 18-23"H

OPTION	PRICE	CODE
Metal Base	59.00	MB
Chrome Base	59.00	CB
Adjustable Back Height	59.00	AB
Upholstered Back	59.00	UB
Assembly	48.00	A
CASTER	PRICE	CODE
Self-Locking Casters	85.00	S
Braking Casters	30.00	B
Hard-Floor Casters	19.00	H
Glides	N/C	GL

Freight Class: 100

Cubic Ft: 11

Ship Weight: 53

**QS**

**320SM30T Midback - Fixed T-arms**

25" W X 24" D X 35-40" H

St. Yardage: 2



Grade	1	2	3	4	5	6	7	8	9	10	L	LL
<b>Zone 1</b>	663	721	765	792	833	887	908	996	1050	1118	1247	1453
<b>Zone 2</b>	673	732	776	804	845	900	922	1011	1066	1135	1266	1475
<b>Zone 3</b>	683	743	788	816	858	914	935	1026	1082	1152	1284	1497

- 16" high back
- Fixed T-arms
- Can ship via ground service
- Requires assembly
- Seat: 21"W x 20"D x 18-23"H

OPTION	PRICE	CODE
Metal Base	59.00	MB
Chrome Base	59.00	CB
Adjustable Back Height	59.00	AB
Upholstered Back	59.00	UB
Assembly	48.00	A

CASTER	PRICE	CODE
Self-Locking Casters	85.00	S
Braking Casters	30.00	B
Hard-Floor Casters	19.00	H
Glides	N/C	GL

Freight Class: 100

Cubic Ft: 11

Ship Weight: 52

**QS**

**320SM Midback - Armless**

21" W X 24" D X 35-40" H

St. Yardage: 2



Grade	1	2	3	4	5	6	7	8	9	10	L	LL
<b>Zone 1</b>	569	627	669	698	739	793	814	902	956	1024	1072	1259
<b>Zone 2</b>	578	636	679	708	750	805	826	916	970	1039	1088	1278
<b>Zone 3</b>	586	646	689	719	761	817	838	929	985	1055	1104	1297

- 16" high back
- Armless
- Can ship via ground service
- Requires assembly
- Seat: 21"W x 20"D x 18-23"H

OPTION	PRICE	CODE
Metal Base	59.00	MB
Chrome Base	59.00	CB
Adjustable Back Height	59.00	AB
Upholstered Back	59.00	UB
Assembly	48.00	A

CASTER	PRICE	CODE
Self-Locking Casters	85.00	S
Braking Casters	30.00	B
Hard-Floor Casters	19.00	H
Glides	N/C	GL

Freight Class: 100

Cubic Ft: 11

Ship Weight: 47

**QS**

**Jaguar Midback - Basic Mechanism**

**320BM30AT Midback - Adjustable T-arms**

26" W X 24" D X 35-40" H

St. Yardage: 2



Grade	1	2	3	4	5	6	7	8	9	10	L	LL
<b>Zone 1</b>	663	721	765	792	833	887	908	996	1050	1118	1247	1453
<b>Zone 2</b>	673	732	776	804	845	900	922	1011	1066	1135	1266	1475
<b>Zone 3</b>	683	743	788	816	858	914	935	1026	1082	1152	1284	1497

- 16" high back
- Adjustable T-arms
- Can ship via ground service
- Requires assembly
- Seat: 21"W x 20"D x 18-23"H

OPTION	PRICE	CODE
Metal Base	59.00	MB
Chrome Base	59.00	CB
Adjustable Back Height	59.00	AB
Full Feature Mechanism (Replace BM with FM)	139.00	FM
Upholstered Back	59.00	UB
Assembly	48.00	A

CASTER	PRICE	CODE
Self-Locking Casters	85.00	S
Braking Casters	30.00	B
Hard-Floor Casters	19.00	H
Glides	N/C	GL

Freight Class: 100

Cubic Ft: 11

Ship Weight: 46

**QS**

### 320BM30T Midback - Fixed T-arms

25" W X 24" D X 35-40" H

St. Yardage: 2



Grade	1	2	3	4	5	6	7	8	9	10	L	LL
<b>Zone 1</b>	<b>632</b>	<b>691</b>	<b>733</b>	<b>761</b>	<b>802</b>	<b>856</b>	<b>877</b>	<b>965</b>	<b>1019</b>	<b>1087</b>	<b>1136</b>	<b>1352</b>
<b>Zone 2</b>	<b>641</b>	<b>701</b>	<b>744</b>	<b>772</b>	<b>814</b>	<b>869</b>	<b>890</b>	<b>979</b>	<b>1034</b>	<b>1103</b>	<b>1153</b>	<b>1372</b>
<b>Zone 3</b>	<b>651</b>	<b>712</b>	<b>755</b>	<b>784</b>	<b>826</b>	<b>882</b>	<b>903</b>	<b>994</b>	<b>1050</b>	<b>1120</b>	<b>1170</b>	<b>1393</b>

- 16" high back
- Fixed T-arms
- Can ship via ground service
- Requires assembly
- Seat: 21"W x 20"D x 18-23"H

OPTION	PRICE	CODE
Metal Base	59.00	MB
Chrome Base	59.00	CB
Adjustable Back Height	59.00	AB
Full Feature Mechanism (Replace BM with FM)	139.00	FM
Upholstered Back	59.00	UB
Assembly	48.00	A
CASTER	PRICE	CODE
Self-Locking Casters	85.00	S
Braking Casters	30.00	B
Hard-Floor Casters	19.00	H
Glides	N/C	GL

Freight Class: 100

Cubic Ft: 11

Ship Weight: 45

**QS**

### 320BM Midback - Armless

21" W X 24" D X 35-40" H

St. Yardage: 2



Grade	1	2	3	4	5	6	7	8	9	10	L	LL
<b>Zone 1</b>	<b>536</b>	<b>595</b>	<b>637</b>	<b>665</b>	<b>706</b>	<b>760</b>	<b>781</b>	<b>869</b>	<b>923</b>	<b>991</b>	<b>1040</b>	<b>1226</b>
<b>Zone 2</b>	<b>544</b>	<b>604</b>	<b>647</b>	<b>675</b>	<b>717</b>	<b>771</b>	<b>793</b>	<b>882</b>	<b>937</b>	<b>1006</b>	<b>1056</b>	<b>1244</b>
<b>Zone 3</b>	<b>552</b>	<b>613</b>	<b>656</b>	<b>685</b>	<b>727</b>	<b>783</b>	<b>804</b>	<b>895</b>	<b>951</b>	<b>1021</b>	<b>1071</b>	<b>1263</b>

- 16" high back
- Armless
- Can ship via ground service
- Requires assembly
- Seat: 21"W x 20"D x 18-23"H

OPTION	PRICE	CODE
Metal Base	59.00	MB
Chrome Base	59.00	CB
Adjustable Back Height	59.00	AB
Full Feature Mechanism (Replace BM with FM)	139.00	FM
Upholstered Back	59.00	UB
Assembly	48.00	A
CASTER	PRICE	CODE
Self-Locking Casters	85.00	S
Braking Casters	30.00	B
Hard-Floor Casters	19.00	H
Glides	N/C	GL

Freight Class: 100

Cubic Ft: 11

Ship Weight: 40

**QS**

**Go Fast with Fast Cats: Cheetah**

In a fast-paced work environment, **Cheetah** will keep you moving.

**Cheetah Features**

- Adjustable seat height, 5" range-Pneumatic
- Adjustable back height, 2" range-Manual
- Adjustable back depth, 2" range
- Free float back angle adjustment
- 360° Swivel
- Resin back & seat pan
- Contoured, molded foam
- Extra-wide seats & bases

**Specifications**

**Overall**

- Width 24" (with arms), Depth 24" Height 32"-37"

**Seat**

- Width 20", Depth 18", Thickness 2.5"

**Back**

- Width 17", Depth 16.5", Thickness 2.5"

**Other**

- Seat Height 18"-23"
- Arm Height from seat 6.5"
- Arm Height from floor 23.5" (Measured with seat/arms in lowest position)

**Arm Choices**

**Adjustable T Arms (AT)**

- 2.5" height adjustments (5 positions)
- 2" wide adjustment (1" per arm)



Armless Task Chair 500

**Cheetah Standard Height**

**50050AT Task Chair**

24" W X 24" D X 32-37" H

St. Yardage: 2



Freight Class: 100

Cubic Ft: 11

**QS** Weight: 44

Grade	1	2	3	4	5	6	7	8	9	10	L	LL
Zone 1	485	539	586	621	664	681	751	795	849	952	994	1097
Zone 2	492	547	595	630	674	691	762	807	862	966	1009	1113
Zone 3	500	555	604	640	684	701	774	819	874	981	1024	1130

- 17" high back
- 360° swivel
- Adjustable T-arms
- Can ship via ground service
- Requires assembly
- Seat: 20"W x 18"D x 18-23"H

OPTION	PRICE	CODE
Assembly	48.00	A
CASTER	PRICE	CODE
Self-Locking Casters	85.00	S
Braking Casters	30.00	B
Hard-Floor Casters	19.00	H
Glides	N/C	GL

**500 Armless Task Chair**

20" W X 24" D X 32-37" H

St. Yardage: 1



Freight Class: 100

Cubic Ft: 11

**QS** Weight: 36

Grade	1	2	3	4	5	6	7	8	9	10	L	LL
Zone 1	381	429	481	494	527	560	577	647	691	745	903	1043
Zone 2	387	435	488	501	535	568	586	657	701	756	917	1059
Zone 3	392	442	495	509	543	577	594	666	712	767	930	1074

- 17" high back
- 360° swivel
- Armless
- Can ship via ground service
- Requires assembly
- Seat: 20"W x 18"D x 18-23"H

OPTION	PRICE	CODE
Assembly	48.00	A
CASTER	PRICE	CODE
Self-Locking Casters	85.00	S
Braking Casters	30.00	B
Hard-Floor Casters	19.00	H
Glides	N/C	GL

# CHEETAH SIN 711-18

FAST CATS ERGONOMIC

## Cheetah Extended Height

### 59050AT Extended-Height Task Chair

24" W X 24" D X 40-50" H

St. Yardage: 1



Freight Class: 100  
Cubic Ft: 12  
Ship Weight: 49

Grade	1	2	3	4	5	6	7	8	9	10	L	LL
<b>Zone 1</b>	<b>682</b>	<b>738</b>	<b>787</b>	<b>818</b>	<b>861</b>	<b>878</b>	<b>948</b>	<b>992</b>	<b>1046</b>	<b>1149</b>	<b>1195</b>	<b>1394</b>
<b>Zone 2</b>	<b>692</b>	<b>749</b>	<b>799</b>	<b>830</b>	<b>874</b>	<b>891</b>	<b>962</b>	<b>1007</b>	<b>1062</b>	<b>1166</b>	<b>1213</b>	<b>1415</b>
<b>Zone 3</b>	<b>702</b>	<b>760</b>	<b>811</b>	<b>843</b>	<b>887</b>	<b>904</b>	<b>976</b>	<b>1022</b>	<b>1077</b>	<b>1183</b>	<b>1231</b>	<b>1436</b>

- 360° swivel
- 10" vertical seat height adjustment (pneumatic)
- 18" diameter foot ring
- 2.5" height-adjustable arms
- 10" vertical foot ring height adjustment (manual)
- 2" arm width adjustment
- Requires assembly
- Seat: 20"W x 18"D x 26-30"H

OPTION	PRICE	CODE
Assembly	48.00	A
CASTER	PRICE	CODE
Self-Locking Casters	85.00	S
Braking Casters	30.00	B
Hard-Floor Casters	19.00	H
Glides	N/C	GL

Seat Height (From Floor) 24-34"    Arm Height (From Seat) 6.5-9"  
Foot Ring Height (From Floor) 8-18"    Back Size 17.5"W x 16.5"D  
Useable Seat Area 18"W x 18"D

**QS**

### 590 Extended-Height Armless Task Chair

20" W X 24" D X 40-50" H

St. Yardage: 1

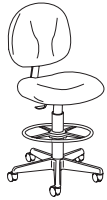

Freight Class: 100  
Cubic Ft: 11  
Ship Weight: 40

Grade	1	2	3	4	5	6	7	8	9	10	L	LL
<b>Zone 1</b>	<b>555</b>	<b>611</b>	<b>663</b>	<b>691</b>	<b>734</b>	<b>751</b>	<b>821</b>	<b>865</b>	<b>919</b>	<b>1022</b>	<b>1069</b>	<b>1267</b>
<b>Zone 2</b>	<b>563</b>	<b>620</b>	<b>673</b>	<b>701</b>	<b>745</b>	<b>762</b>	<b>833</b>	<b>878</b>	<b>933</b>	<b>1037</b>	<b>1085</b>	<b>1286</b>
<b>Zone 3</b>	<b>572</b>	<b>629</b>	<b>683</b>	<b>712</b>	<b>756</b>	<b>774</b>	<b>846</b>	<b>891</b>	<b>947</b>	<b>1053</b>	<b>1101</b>	<b>1305</b>

- 360° swivel
- 10" vertical seat height adjustment (pneumatic)
- 18" diameter foot ring
- Armless
- 10" vertical foot ring height adjustment (manual)
- Requires assembly
- Seat: 20"W x 18"D x 26-30"H

OPTION	PRICE	CODE
Assembly	48.00	A
CASTER	PRICE	CODE
Self-Locking Casters	85.00	S
Braking Casters	30.00	B
Hard-Floor Casters	19.00	H
Glides	N/C	GL

Seat Height (From Floor) 24-34"    Arm Height (From Seat) 6.5-9"  
Foot Ring Height (From Floor) 8-18"    Back Size 17.5"W x 16.5"D  
Useable Seat Area 18"W x 18"D

**QS**



**Go Fast with Fast Cats: Lynx**

The **Lynx** collection offers comfort and value at an affordable price point. In addition to thousands of upholstery possibilities, Lynx is also available in three value-priced fabrics—blue, black & burgundy. Lynx chairs upholstered in these value fabrics can be ordered and shipped rapidly.

**Lynx Design Details**

- Adjustable height T-arms
- Tilt tension adjustment
- Swivel Tilt-lock mechanism
- 50mm twin-wheel carpet casters for easy maneuverability
- 3 value-priced fabrics (Black, Blue & Burgundy)
- 1,000s of additional upholsteries available
- Assembled ship weight is 44 lb
- Assembled cubes is 16



407

**Lynx**

**407 Lynx Chair In Any Upholstery**

25" W X 26" D X 35-38.5" H St. Yardage: 2.25



Freight Class: 100

**QS** Cubic Ft: 5

Ship Weight: 41

Grade	1	2	3	4	5	6	7	8	9	10	L	LL
<b>Zone 1</b>	409	441	477	525	562	611	830	709	758	819	926	1110
<b>Zone 2</b>	415	448	484	533	570	620	842	720	769	831	940	1127
<b>Zone 3</b>	421	454	491	541	579	629	855	730	781	844	954	1143

	OPTION	PRICE	CODE
• Swivel tilt-lock mechanism			
• Tilt tension adjustment			
• Adjustable height T-arms			
• Requires assembly			
• 50mm twin-wheel carpet casters			
• Available in any upholstery			
• Seat: 20"W x 19"D x 17-20.5"H			
Assembly		48.00	A

**407B Task Chair in Promotional Blue Fabric**



**QS**

Freight Class: 100

- Swivel tilt-lock mechanism
- Tilt tension adjustment
- Adjustable height T-arms
- 50mm twin-wheel carpet casters
- Requires assembly
- Seat: 20"W x 19"D x 17-20.5"H

	Zone Pricing	1	2	3
25" X 26" X 35-38.5" Cubic Ft: 5 Ship Weight: 41		<b>323</b>	<b>328</b>	<b>333</b>

OPTION	PRICE	CODE
Assembly	48.00	A

**407C Task Chair in Promotional Black Fabric**



**QS**

Freight Class: 100

- Swivel tilt-lock mechanism
- Tilt tension adjustment
- Adjustable height T-arms
- 50mm twin-wheel carpet casters
- Requires assembly
- Seat: 20"W x 19"D x 17-20.5"H

25" X 26" X 35-38.5" Cubic Ft: 5 Ship Weight: 41	<b>323</b>	<b>328</b>	<b>333</b>
--	------------	------------	------------

OPTION	PRICE	CODE
Assembly	48.00	A

**407R Task Chair in Promotional Burgundy Fabric**



**QS**

Freight Class: 100

- Swivel tilt-lock mechanism
- Tilt tension adjustment
- Adjustable height T-arms
- 50mm twin-wheel carpet casters
- Requires assembly
- Seat: 20"W x 19"D x 17-20.5"H

25" X 26" X 35-38.5" Cubic Ft: 5 Ship Weight: 41	<b>323</b>	<b>328</b>	<b>333</b>
--	------------	------------	------------

OPTION	PRICE	CODE
Assembly	48.00	A

# LEADERS EXECUTIVE SIN 711-18

## FINISH SELECTION

NATURAL MAPLE **FM** | ASPEN **AP** | PEARWOOD **PW** | WINDSOR CHERRY **WC**  
 | MAHOGANY **MAH** | MOAB **MOB** | ESPRESSO **ESP** | CLASSIC CHERRY **CCY** |  
 WALNUT **WAL** | HONEY CHERRY **HCY** | ROUGE MAHOGANY **RM** | BLACK **BLK** |

LEADERS EXECUTIVE

### Oversized Comfort

Leaders chairs are designed and built for executive level style and comfort. With careful attention to detail, they are scaled for the executive office. Impressive in every environment.

### Design Details

- **Traditional**— *Period influenced styling with gooseneck, wingback and other classical styles*
- **Transitional**— *Large-scaled seating designed with comfort in mind. Recommended for larger, longer body types*
- **Contemporary**— *Square-pattern stitching is paired with oversize seat & back for unique and comfortable styling*

### Additional Options

- *Optional Knee Tilt*



Executive 121



Executive 141



Executive 161



Executive 101

## Leaders Executive

### 101 Executive Swivel, Spider Base

27.5" W X 29" D X 43.5-46.5" H St. Yardage: 4



Freight Class: 150  
 Cubic Ft: 26  
 Ship Weight: 68

Grade	1	2	3	4	5	6	7	8	9	10	L	LL
Zone 1	1757	1873	1986	1999	2063	2161	2198	2356	2454	2576	2932	3359
Zone 2	1783	1901	2016	2029	2094	2193	2231	2391	2491	2615	2976	3409
Zone 3	1810	1929	2046	2059	2125	2226	2264	2427	2528	2653	3020	3460

- Generous seat width/depth
- Dual-composition cushioning
- Fully upholstered
- Pneumatic lift
- Tilt tension adjustment
- Black, nylon reinforced spider base
- Black dual-wheel carpet casters
- Seat: 21"W x 19"D x 20-23"H

OPTION	PRICE	CODE
Knee Tilt Control	100.00	K
CASTER	PRICE	CODE
Self-Locking Casters	85.00	S
Braking Casters	30.00	B
Hard-Floor Casters	19.00	H
Glides	N/C	GL

QS

### 101 Executive Swivel, Wood Base

27.5" W X 29" D X 43.5-46.5" H St. Yardage: 4



Freight Class: 150  
 Cubic Ft: 26  
 Ship Weight: 68

Grade	1	2	3	4	5	6	7	8	9	10	L	LL
Zone 1	1875	1990	2105	2117	2181	2279	2316	2474	2572	2694	3050	3477
Zone 2	1903	2020	2137	2149	2214	2313	2351	2511	2611	2734	3096	3529
Zone 3	1931	2050	2168	2181	2246	2347	2385	2548	2649	2775	3142	3581

- Same description as above except:
- Two-tone, low-profile base with black die-cast aluminum structure
- Wood caps; specify finish designator
- Seat: 21"W x 19"D x 20-23"H

OPTION	PRICE	CODE
Knee Tilt Control	100.00	K
CASTER	PRICE	CODE
Self-Locking Casters	85.00	S
Braking Casters	30.00	B
Hard-Floor Casters	19.00	H
Glides	N/C	GL

QS

# FINISH SELECTION

NATURAL MAPLE **FM** | ASPEN **AP** | PEARWOOD **PW** | WINDSOR CHERRY **WC**  
 | MAHOGANY **MAH** | MOAB **MOB** | ESPRESSO **ESP** | CLASSIC CHERRY **CCY** |  
 WALNUT **WAL** | HONEY CHERRY **HCY** | ROUGE MAHOGANY **RM** | BLACK **BLK** |

# SIN 711-18 LEADERS EXECUTIVE

LEADERS EXECUTIVE

## 121 Executive Swivel, Spider Base

27" W X 32" D X 43-47" H

St. Yardage: 5



Freight Class: 150  
 Cubic Ft: 26  
 Ship Weight: 73

Grade	1	2	3	4	5	6	7	8	9	10	L	LL
Zone 1	1894	2028	2163	2175	2251	2365	2409	2593	2707	2850	3261	3763
Zone 2	1922	2058	2195	2208	2285	2400	2445	2632	2748	2893	3310	3819
Zone 3	1951	2089	2228	2240	2319	2436	2481	2671	2788	2936	3359	3876

- Generous seat width/depth
- Dual-composition cushioning
- Fully upholstered
- Pneumatic lift
- Tilt tension adjustment
- Black, nylon reinforced spider base
- Black dual-wheel carpet casters
- Seat: 20"W x 20"D x 21-25"H

OPTION	PRICE	CODE
Knee Tilt Control	100.00	K
Softer Seat Foam-Chair	16.00	SF
Edge Guard	16.00	E
CASTER	PRICE	CODE
Self-Locking Casters	85.00	S
Braking Casters	30.00	B
Hard-Floor Casters	19.00	H
Glides	N/C	GL

**QS**

## 121\_ Executive Swivel, Wood Base

27" W X 32" D X 43-47" H

St. Yardage: 5



Freight Class: 150  
 Cubic Ft: 26  
 Ship Weight: 73

Grade	1	2	3	4	5	6	7	8	9	10	L	LL
Zone 1	2011	2145	2282	2299	2368	2482	2526	2710	2824	2967	3377	3880
Zone 2	2041	2177	2316	2333	2404	2519	2564	2751	2866	3012	3428	3938
Zone 3	2071	2209	2350	2368	2439	2556	2602	2791	2909	3056	3478	3996

- Same description as above except:
- Two-tone, low-profile base with black die-cast aluminum structure
- Wood caps; specify finish designator

OPTION	PRICE	CODE
Knee Tilt Control	100.00	K
Softer Seat Foam-Chair	16.00	SF
Edge Guard	16.00	E
CASTER	PRICE	CODE
Self-Locking Casters	85.00	S
Braking Casters	30.00	B
Hard-Floor Casters	19.00	H
Glides	N/C	GL

**QS**

## 191 Executive Swivel, Spider Base

30.25" W X 31.5" D X 42.5-45.5" H

St. Yardage: 6



Freight Class: 150  
 Cubic Ft: 26  
 Ship Weight: 73

Grade	1	2	3	4	5	6	7	8	9	10	L	LL
Zone 1	1361	1538	1680	1691	1769	1899	1949	2160	2290	2453	3293	3497
Zone 2	1381	1561	1705	1716	1796	1927	1978	2192	2324	2490	3342	3549
Zone 3	1402	1584	1730	1742	1822	1956	2007	2225	2359	2527	3392	3602

- Welt cord trim
- Dual-composition cushioning
- Fully upholstered
- Pneumatic lift
- Tilt tension adjustment
- Black, nylon reinforced spider base
- Black dual-wheel carpet casters
- Seat: 18.5"W x 19"D x 17.5-20.5"H

OPTION	PRICE	CODE
Knee Tilt Control	100.00	K
Softer Seat Foam-Chair	16.00	SF
Edge Guard	16.00	E
CASTER	PRICE	CODE
Self-Locking Casters	85.00	S
Braking Casters	30.00	B
Hard-Floor Casters	19.00	H
Glides	N/C	GL

**QS**

ALL FOAM & FABRICS USED ARE CAL 117 APPROVED

**QS** indicates a Quickship item if ordered in Quickship upholstery. Quick Ship is not available on any item ordered with options.

# LEADERS EXECUTIVE SIN 711-18

## FINISH SELECTION

NATURAL MAPLE **FM** | ASPEN **AP** | PEARWOOD **PW** | WINDSOR CHERRY **WC**  
 | MAHOGANY **MAH** | MOAB **MOB** | ESPRESSO **ESP** | CLASSIC CHERRY **CCY** |  
 WALNUT **WAL** | HONEY CHERRY **HCY** | ROUGE MAHOGANY **RM** | BLACK **BLK** |

### 191\_ Executive Swivel, Wood Base

30.25" W X 31.5" D X 42.5-45.5" H St. Yardage: 6



Freight Class: 150  
 Cubic Ft: 26  
 Ship Weight: 73

Grade	1	2	3	4	5	6	7	8	9	10	L	LL
Zone 1	1485	1663	1804	1815	1893	2023	2073	2284	2414	2577	3417	3621
Zone 2	1507	1688	1831	1842	1921	2053	2104	2318	2450	2616	3468	3675
Zone 3	1530	1713	1858	1869	1950	2084	2135	2353	2486	2654	3520	3730

- Same description as above except:
- Two-tone, low-profile base with black die-cast aluminum structure
- Wood caps; specify finish designator
- Seat: 18.5"W x 19"D x 17.5-20.5"H

OPTION	PRICE	CODE
Knee Tilt Control	100.00	K
Softer Seat Foam-Chair	16.00	SF
Edge Guard	16.00	E
CASTER	PRICE	CODE
Self-Locking Casters	85.00	S
Braking Casters	30.00	B
Hard-Floor Casters	19.00	H
Glides	N/C	GL

**QS**

### 141 Executive Swivel, Spider Base

26.5" W X 31" D X 41.5-45" H St. Yardage: 3.5



Freight Class: 150  
 Cubic Ft: 21  
 Ship Weight: 61

Grade	1	2	3	4	5	6	7	8	9	10	L	LL
Zone 1	1580	1730	1869	1886	1935	1984	2021	2179	2277	2399	3182	3305
Zone 2	1604	1756	1897	1914	1964	2014	2051	2212	2311	2435	3230	3355
Zone 3	1627	1782	1925	1943	1993	2044	2082	2244	2345	2471	3277	3404

- Generous seat width/depth
- Dual-composition cushioning
- Square pattern stitching with hand pulled reliefs
- For other Himalaya options, see page 319
- Fully upholstered
- Pneumatic lift
- Tilt tension adjustment
- Black, nylon reinforced spider base
- Black dual-wheel carpet casters
- Seat: 20.5"W x 20.5"D x 18-22"H

OPTION	PRICE	CODE
Knee Tilt Control	100.00	K
Softer Seat Foam-Chair	16.00	SF
Edge Guard	16.00	E
CASTER	PRICE	CODE
Self-Locking Casters	85.00	S
Braking Casters	30.00	B
Hard-Floor Casters	19.00	H
Glides	N/C	GL

**QS**

### 141\_ Executive Swivel, Wood Base

26.5" W X 31" D X 41.5-45" H St. Yardage: 3.5



Freight Class: 150  
 Cubic Ft: 21  
 Ship Weight: 61

Grade	1	2	3	4	5	6	7	8	9	10	L	LL
Zone 1	1696	1848	1985	2002	2100	2137	2295	2393	2515	2748	3298	3422
Zone 2	1721	1876	2015	2032	2132	2169	2329	2429	2553	2789	3347	3473
Zone 3	1747	1903	2045	2062	2163	2201	2364	2465	2590	2830	3397	3525

- Same description as above except:
- Two-tone, low-profile base with black die-cast aluminum structure
- Wood caps; specify finish designator
- Seat: 20.5"W x 20.5"D x 17.5-21.5"H

OPTION	PRICE	CODE
Knee Tilt Control	100.00	K
Softer Seat Foam-Chair	16.00	SF
Edge Guard	16.00	E
CASTER	PRICE	CODE
Self-Locking Casters	85.00	S
Braking Casters	30.00	B
Hard-Floor Casters	19.00	H
Glides	N/C	GL

**QS**

### 143 Executive Swivel, Wood Base

22.75" W X 26" D X 33.5" H St. Yardage: 1.75



Freight Class: 150  
 Cubic Ft: 15  
 Ship Weight: 27

Grade	1	2	3	4	5	6	7	8	9	10	L	LL
Zone 1	951	1028	1095	1121	1175	1196	1284	1338	1406	1535	1779	1841
Zone 2	965	1043	1111	1138	1193	1214	1303	1358	1427	1558	1806	1869
Zone 3	980	1059	1128	1155	1210	1232	1323	1378	1448	1581	1832	1896

- Exposed legs and arms are solid hardwood
- Specify wood finish
- Square pattern stitching with hand pulled reliefs
- For other Himalaya options, see page 319
- Seat: 19"W x 18"D x 19"H

OPTION	PRICE	CODE
Softer Seat Foam-Chair	16.00	SF
Edge Guard	16.00	E

**QS**

ALL FOAM & FABRICS USED ARE CAL 117 APPROVED

**QS** indicates a Quickship item if ordered in Quickship upholstery. Quick Ship is not available on any item ordered with options.

**FINISH SELECTION**

NATURAL MAPLE **FM** | ASPEN **AP** | PEARWOOD **PW** | WINDSOR CHERRY **WC**  
 | MAHOGANY **MAH** | MOAB **MOB** | ESPRESSO **ESP** | CLASSIC CHERRY **CCY** |  
 WALNUT **WAL** | HONEY CHERRY **HCY** | ROUGE MAHOGANY **RM** | BLACK **BLK** |

SIN 711-18 **LEADERS EXECUTIVE**

LEADERS EXECUTIVE

**144 Armless Side Chair**

19.5" W X 26" D X 33.5" H

St. Yardage: 1.75



Freight Class: 150  
 Cubic Ft: 15  
 Ship Weight: 25

Grade	1	2	3	4	5	6	7	8	9	10	L	LL
<b>Zone 1</b>	915	955	1055	1085	1139	1160	1248	1302	1370	1499	1721	1805
<b>Zone 2</b>	929	969	1071	1101	1156	1177	1267	1322	1391	1521	1747	1832
<b>Zone 3</b>	942	984	1087	1118	1173	1195	1285	1341	1411	1544	1773	1859

- Exposed legs are solid hardwood
- Specify wood finish
- Square pattern stitching with hand pulled reliefs
- For other Himalaya options, see page 319
- Seat: 19"W x 18"D x 19"H

OPTION	PRICE	CODE
Softer Seat Foam-Chair	16.00	SF
Edge Guard	16.00	E

**QS**

**161 Executive Swivel, Spider Base**

27.25" W X 32" D X 42-45" H

St. Yardage: 3.5



Freight Class: 150  
 Cubic Ft: 26  
 Ship Weight: 63

Grade	1	2	3	4	5	6	7	8	9	10	L	LL
<b>Zone 1</b>	1580	1730	1869	1889	1939	1972	2043	2113	2200	2308	3004	3305
<b>Zone 2</b>	1604	1756	1897	1917	1968	2002	2074	2145	2233	2343	3049	3355
<b>Zone 3</b>	1627	1782	1925	1946	1997	2031	2104	2176	2266	2377	3094	3404

- Generous seat width/depth
- Dual-composition cushioning
- Fully upholstered
- Pneumatic lift
- Tilt tension adjustment
- Black, nylon reinforced spider base
- Black dual-wheel carpet casters
- Seat: 20.5"W x 20.5"D x 19-22"H

OPTION	PRICE	CODE
Knee Tilt Control	100.00	K
Softer Seat Foam-Chair	16.00	SF
Edge Guard	16.00	E

CASTER	PRICE	CODE
Self-Locking Casters	85.00	S
Braking Casters	30.00	B
Hard-Floor Casters	19.00	H
Glides	N/C	GL

**QS**

**161\_ Executive Swivel, Wood Base**

27.25" W X 32" D X 42-45" H

St. Yardage: 3.5

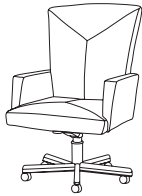

Freight Class: 150  
 Cubic Ft: 26  
 Ship Weight: 63

Grade	1	2	3	4	5	6	7	8	9	10	L	LL
<b>Zone 1</b>	1696	1848	1985	2055	2088	2159	2229	2316	2424	2631	3120	3422
<b>Zone 2</b>	1721	1876	2015	2086	2119	2191	2262	2351	2460	2670	3167	3473
<b>Zone 3</b>	1747	1903	2045	2117	2151	2224	2296	2385	2497	2710	3214	3525

- Same description as above except:
- Two-tone, low-profile base with black die-cast aluminum structure
- Wood caps; specify finish designator

OPTION	PRICE	CODE
Knee Tilt Control	100.00	K
Softer Seat Foam-Chair	16.00	SF
Edge Guard	16.00	E

CASTER	PRICE	CODE
Self-Locking Casters	85.00	S
Braking Casters	30.00	B
Hard-Floor Casters	19.00	H
Glides	N/C	GL

**QS**

**163 Arm Chair**

22.75" W X 26" D X 33.5" H

St. Yardage: 1.75



Freight Class: 150  
 Cubic Ft: 15  
 Ship Weight: 27

Grade	1	2	3	4	5	6	7	8	9	10	L	LL
<b>Zone 1</b>	957	1028	1100	1127	1181	1202	1290	1344	1412	1541	1779	1847
<b>Zone 2</b>	971	1043	1117	1144	1199	1220	1309	1364	1433	1564	1806	1875
<b>Zone 3</b>	986	1059	1133	1161	1216	1238	1329	1384	1454	1587	1832	1902

- Exposed legs and arms are solid hardwood
- Specify wood finish
- Seat: 19"W x 17"D x 19"H

OPTION	PRICE	CODE
Softer Seat Foam-Chair	16.00	SF
Edge Guard	16.00	E

**QS**

**ALL FOAM & FABRICS USED ARE CAL 117 APPROVED**

**QS** indicates a Quickship item if ordered in Quickship upholstery. Quick Ship is not available on any item ordered with options.

# LEADERS EXECUTIVE

SIN 711-18

## FINISH SELECTION

NATURAL MAPLE **FM** | ASPEN **AP** | PEARWOOD **PW** | WINDSOR CHERRY **WC**  
 | MAHOGANY **MAH** | MOAB **MOB** | ESPRESSO **ESP** | CLASSIC CHERRY **CCY** |  
 WALNUT **WAL** | HONEY CHERRY **HCY** | ROUGE MAHOGANY **RM** | BLACK **BLK** |

### 164 Armless Side Chair

19.5" W X 26" D X 33.5" H

St. Yardage: 1.75



Freight Class: 150

Cubic Ft: 15

Ship Weight: 25

Grade	1	2	3	4	5	6	7	8	9	10	L	LL
<b>Zone 1</b>	915	955	1055	1085	1139	1160	1248	1302	1370	1499	1721	1805
<b>Zone 2</b>	929	969	1071	1101	1156	1177	1267	1322	1391	1521	1747	1832
<b>Zone 3</b>	942	984	1087	1118	1173	1195	1285	1341	1411	1544	1773	1859

- Exposed legs are solid hardwood
- Specify wood finish
- Seat: 19"W x 17"D x 19"H

OPTION	PRICE	CODE
Softer Seat Foam-Chair	16.00	SF
Edge Guard	16.00	E

**QS**

### 192\_ Executive Swivel

30" W X 31" D X 42.5-45" H

St. Yardage: 6



Freight Class: 150

Cubic Ft: 26

Ship Weight: 83

Grade	1	2	3	4	5	6	7	8	9	10	L	LL
<b>Zone 1</b>	1436	1615	1759	1844	1894	1974	2024	2235	2365	2528	3371	3572
<b>Zone 2</b>	1458	1639	1785	1872	1922	2004	2054	2269	2400	2566	3422	3626
<b>Zone 3</b>	1479	1663	1812	1899	1951	2033	2085	2302	2436	2604	3472	3679

- Extra-high back
- Thickly padded foam seat
- Brass nail head trim on arms and seat
- 5-prong steel base with hardwood caps
- Pneumatic seat-height adjustment
- Black dual-wheel carpet casters
- Seat: 18.5"W x 19"D x 17.5-20.5"H

OPTION	PRICE	CODE
Knee Tilt Control	100.00	K
No Brass Trim Option	N/C	NB
Softer Seat Foam-Chair	16.00	SF
Edge Guard	16.00	E

CASTER	PRICE	CODE
Self-Locking Casters	85.00	S
Braking Casters	30.00	B
Hard-Floor Casters	19.00	H
Glides	N/C	GL

**QS**



# FINISH SELECTION

PEARWOOD **PW** | ROUGE MAHOGANY **RM** | MAHOGANY **MAH** | ASPEN **AP** | NATURAL **FM** | HONEY CHERRY **HCY** | WALNUT **WAL** | WINDSOR CHERRY **WC** | CLASSIC CHERRY **CCY** | ESPRESSO **ESP** | MEDIUM OAK **OAK** | NATURAL OAK **NOK** | BLACK **BLK**

SIN 711-18 **SCOOP**

## Scoop the Competition with Style

With solid good looks and many style options, **Scoop** is a winner for any office environment. Style options include a choice between wood and urethane arms and base and a wide choice of fabrics and leathers.

## Scoop Design Details

- Two back upholstery styles available: channel stitched back and original, non-stitched back
- Choose from black urethane arms and base or wood arms and base
- Built-in lumbar support

## Additional Options

- Optional Knee Tilt control
- Self locking, braking or hard-floor casters

## Additional Information

- Coordinating guest chairs available



Executive 1071  
Management 1117



Executive 1001

CONTEMPORARY OFFICE

# SCOOP

## 1001 Executive Swivel

25" W X 28.5" D X 37-40" H St. Yardage: 3



Freight Class: 150  
Cubic Ft: 21  
Ship Weight: 49

Grade	1	2	3	4	5	6	7	8	9	10	L	LL
Zone 1	996	1082	1156	1200	1265	1290	1395	1461	1542	1697	1820	2064
Zone 2	1011	1098	1173	1218	1284	1309	1416	1483	1565	1722	1847	2095
Zone 3	1026	1114	1191	1236	1303	1329	1437	1505	1588	1748	1875	2126

- Wood arms and base caps
- 5-prong steel base with hardwood caps
- Pneumatic seat-height adjustment
- Standard swivel tilt
- Dual wheel carpet casters
- Available in the finishes listed except OAK and NOK
- Seat: 20"W x 19"D x 17-20.5"H

OPTION	PRICE	CODE
Knee Tilt Control	100.00	K
CASTER	PRICE	CODE
Self-Locking Casters	85.00	S
Braking Casters	30.00	B
Hard-Floor Casters	19.00	H
Glides	N/C	GL

## QS

## 1003 Arm Chair

24" W X 27" D X 33" H St. Yardage: 2



Freight Class: 150  
Cubic Ft: 15  
Ship Weight: 31

Grade	1	2	3	4	5	6	7	8	9	10	L	LL
Zone 1	561	620	671	697	740	757	827	871	925	1028	1142	1273
Zone 2	569	629	681	707	751	768	839	884	939	1043	1159	1292
Zone 3	578	639	691	718	762	780	852	897	953	1059	1176	1311

- Wood arms/legs
- Gangable up to 4 chairs
- Price shown is per chair
- Available in the finishes listed
- Seat: 20"W x 19"D x 18.5"H

**Note:** Add a "C" to the product number for each ganged chair, and multiply number of chairs by correct list price. Ex: 1003CC (3 chairs)

## QS

## 1004 Sled Base Arm Chair

24" W X 28" D X 33" H St. Yardage: 2



Freight Class: 150  
Cubic Ft: 15  
Ship Weight: 33

Grade	1	2	3	4	5	6	7	8	9	10	L	LL
Zone 1	620	677	691	723	756	799	816	886	930	984	1087	1332
Zone 2	629	687	701	734	767	811	828	899	944	999	1103	1352
Zone 3	639	697	712	745	779	823	840	913	958	1014	1120	1372

- Wood arms and sled base
- Gangable up to 4 chairs
- Price shown is per chair
- Available in the finishes listed
- Seat: 20"W x 19"D x 18.5"H

**Note:** Add a "C" to the product number for each ganged chair, and multiply number of chairs by correct list price. Ex: 1003CC (3 chairs)

ALL FOAM & FABRICS USED ARE CAL 117 APPROVED

**QS** indicates a Quickship item if ordered in Quickship upholstery. Quick Ship is not available on any item ordered with options.

# SCOOP SIN 711-18

## FINISH SELECTION

PEARWOOD **PW** | ROUGE MAHOGANY **RM** | MAHOGANY **MAH** | ASPEN **AP** | NATURAL **FM** | HONEY CHERRY **HCY** | WALNUT **WAL** | WINDSOR CHERRY **WC** | CLASSIC CHERRY **CCY** | ESPRESSO **ESP** | MEDIUM OAK **OAK** | NATURAL OAK **NOK** | | BLACK **BLK**

CONTEMPORARY OFFICE

### T1005 Ganging Table (Table Only)

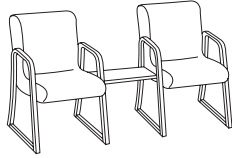

- Wood veneer table can be shipped via ground service
- Available in the finishes listed above
- Also available in black, specify T1005B

Freight Class: 70

23" W X 15" D X 2" H	Cubic Ft: 1	Ship Weight: 10	<b>189</b>	<b>192</b>	<b>195</b>
----------------------	-------------	-----------------	------------	------------	------------

**QS**

### 1007 Management Swivel



Freight Class: 150

Cubic Ft: 19

Ship Weight: 48

25" W X 27" D X 32-35" H St. Yardage: 2

Grade	1	2	3	4	5	6	7	8	9	10	L	LL
<b>Zone 1</b>	<b>854</b>	<b>911</b>	<b>925</b>	<b>957</b>	<b>990</b>	<b>1033</b>	<b>1050</b>	<b>1120</b>	<b>1164</b>	<b>1218</b>	<b>1321</b>	<b>1566</b>
<b>Zone 2</b>	<b>867</b>	<b>925</b>	<b>939</b>	<b>971</b>	<b>1005</b>	<b>1048</b>	<b>1066</b>	<b>1137</b>	<b>1181</b>	<b>1236</b>	<b>1341</b>	<b>1589</b>
<b>Zone 3</b>	<b>880</b>	<b>938</b>	<b>953</b>	<b>986</b>	<b>1020</b>	<b>1064</b>	<b>1082</b>	<b>1154</b>	<b>1199</b>	<b>1255</b>	<b>1361</b>	<b>1613</b>

- Wood arms
- 5-prong steel base with hardwood caps
- Pneumatic seat-height adjustment

- Standard swivel tilt
- Dual wheel carpet casters
- Available in the finishes listed except OAK and NOK
- Seat: 20"W x 19"D x 17-20.5"H

OPTION	PRICE	CODE
Jury Base	315.00	JB
Knee Tilt Control	100.00	K
CASTER	PRICE	CODE
Self-Locking Casters	85.00	S
Braking Casters	30.00	B
Hard-Floor Casters	19.00	H
Glides	N/C	GL

**QS**

### 1071 Executive Swivel



Freight Class: 150

Cubic Ft: 21

Ship Weight: 45

24.5" W X 28" D X 37-40" H St. Yardage: 3

Grade	1	2	3	4	5	6	7	8	9	10	L	LL
<b>Zone 1</b>	<b>884</b>	<b>933</b>	<b>990</b>	<b>1039</b>	<b>1088</b>	<b>1153</b>	<b>1178</b>	<b>1283</b>	<b>1349</b>	<b>1430</b>	<b>1905</b>	<b>1952</b>
<b>Zone 2</b>	<b>897</b>	<b>947</b>	<b>1005</b>	<b>1055</b>	<b>1104</b>	<b>1170</b>	<b>1196</b>	<b>1302</b>	<b>1369</b>	<b>1451</b>	<b>1934</b>	<b>1981</b>
<b>Zone 3</b>	<b>911</b>	<b>961</b>	<b>1020</b>	<b>1070</b>	<b>1121</b>	<b>1188</b>	<b>1213</b>	<b>1321</b>	<b>1389</b>	<b>1473</b>	<b>1962</b>	<b>2011</b>

- Black urethane arm
- Black nylon reinforced 5-prong base
- Pneumatic seat-height adjustment
- Standard swivel tilt
- Dual wheel carpet casters

- Seat: 20"W x 19"D x 17-20.5"H

OPTION	PRICE	CODE
Knee Tilt Control	100.00	K
Edge Guard	16.00	E
CASTER	PRICE	CODE
Self-Locking Casters	85.00	S
Braking Casters	30.00	B
Hard-Floor Casters	19.00	H
Glides	N/C	GL

**QS**

### 1077 Management Swivel



Freight Class: 150

Cubic Ft: 19

Ship Weight: 43

24.5" W X 27" D X 32-35" H St. Yardage: 2

Grade	1	2	3	4	5	6	7	8	9	10	L	LL
<b>Zone 1</b>	<b>822</b>	<b>879</b>	<b>930</b>	<b>977</b>	<b>1026</b>	<b>1091</b>	<b>1116</b>	<b>1221</b>	<b>1287</b>	<b>1368</b>	<b>1500</b>	<b>1690</b>
<b>Zone 2</b>	<b>834</b>	<b>892</b>	<b>944</b>	<b>992</b>	<b>1041</b>	<b>1107</b>	<b>1133</b>	<b>1239</b>	<b>1306</b>	<b>1389</b>	<b>1523</b>	<b>1715</b>
<b>Zone 3</b>	<b>847</b>	<b>905</b>	<b>958</b>	<b>1006</b>	<b>1057</b>	<b>1124</b>	<b>1149</b>	<b>1258</b>	<b>1326</b>	<b>1409</b>	<b>1545</b>	<b>1741</b>

- Black urethane arm
- Black nylon reinforced 5-prong base
- Pneumatic seat-height adjustment
- Standard swivel tilt
- Dual wheel carpet casters

- Seat: 20"W x 19"D x 17-20.5"H

OPTION	PRICE	CODE
Jury Base	315.00	JB
Knee Tilt Control	100.00	K
Edge Guard	16.00	E
CASTER	PRICE	CODE
Self-Locking Casters	85.00	S
Braking Casters	30.00	B
Hard-Floor Casters	19.00	H
Glides	N/C	GL

**QS**

**FINISH SELECTION**

PEARWOOD **PW** | ROUGE MAHOGANY **RM** | MAHOGANY **MAH** | ASPEN **AP** | NATURAL **FM** | HONEY CHERRY **HCY** | WALNUT **WAL** | WINDSOR CHERRY **WC** | CLASSIC CHERRY **CCY** | ESPRESSO **ESP** | MEDIUM OAK **OAK** | NATURAL OAK **NOK** | BLACK **BLK**

SIN 711-18 **SCOOP**

CONTEMPORARY OFFICE

**1091 Executive Swivel**

25" W X 28.5" D X 37-40" H St. Yardage: 3



Freight Class: 150  
Cubic Ft: 21  
Ship Weight: 49

Grade	1	2	3	4	5	6	7	8	9	10	L	LL
<b>Zone 1</b>	884	933	990	1039	1088	1153	1178	1283	1349	1430	1905	1952
<b>Zone 2</b>	897	947	1005	1055	1104	1170	1196	1302	1369	1451	1934	1981
<b>Zone 3</b>	911	961	1020	1070	1121	1188	1213	1321	1389	1473	1962	2011

- Channel style back
- Black urethane arm
- Black nylon reinforced 5-prong base
- Pneumatic seat-height adjustment
- Standard swivel tilt
- Dual wheel carpet casters
- Seat: 20"W x 19"D x 17-20.5"H

OPTION	PRICE	CODE
Knee Tilt Control	100.00	K
Edge Guard	16.00	E
CASTER	PRICE	CODE
Self-Locking Casters	85.00	S
Braking Casters	30.00	B
Hard-Floor Casters	19.00	H
Glides	N/C	GL

**QS**

**1093 Arm Chair**

25" W X 28.5" D X 37-40" H St. Yardage: 3



Freight Class: 150  
Cubic Ft: 15  
Ship Weight: 31

Grade	1	2	3	4	5	6	7	8	9	10	L	LL
<b>Zone 1</b>	642	698	713	745	778	821	838	908	952	1006	1109	1354
<b>Zone 2</b>	652	708	724	756	790	833	851	922	966	1021	1126	1374
<b>Zone 3</b>	661	719	734	767	801	846	863	935	981	1036	1142	1395

- Channel style back
- Wood arms/legs
- Black (BLK) finish standard
- Gangable up to 4 chairs
- Prices shown is per chair
- Seat: 20"W x 19"D x 18.5"H

**Note:** Add a "C" to the product number for each ganged chair, and multiply number of chairs by correct list price. Ex: 1093CCC (3 chairs)

**QS**

**1094 Sled Base Arm Chair**

23.5" W X 27" D X 33" H St. Yardage: 2



Freight Class: 150  
Cubic Ft: 15  
Ship Weight: 33

Grade	1	2	3	4	5	6	7	8	9	10	L	LL
<b>Zone 1</b>	699	732	770	802	835	878	895	965	1009	1063	1266	1411
<b>Zone 2</b>	709	743	782	814	848	891	908	979	1024	1079	1285	1432
<b>Zone 3</b>	720	754	793	826	860	904	922	994	1039	1095	1304	1453

- Channel style back
- Wood arms and sled base
- Black (BLK) finish standard
- Gangable up to 4 chairs
- Prices shown is per chair
- Seat: 20"W x 19"D x 18.5"H

**Note:** Add a "C" to the product number for each ganged chair, and multiply number of chairs by correct list price. Ex: 1094CCC (3 chairs)

**QS**

**1097 Management Swivel**

24.5" W X 27" D X 32-35" H St. Yardage: 2



Freight Class: 150  
Cubic Ft: 19  
Ship Weight: 46

Grade	1	2	3	4	5	6	7	8	9	10	L	LL
<b>Zone 1</b>	848	881	919	951	984	1027	1044	1114	1158	1212	1315	1560
<b>Zone 2</b>	861	894	933	965	999	1042	1060	1131	1175	1230	1335	1583
<b>Zone 3</b>	873	907	947	980	1014	1058	1075	1147	1193	1248	1354	1607

- Channel style back
- Black urethane arm
- Black nylon reinforced 5-prong base
- Pneumatic seat-height adjustment
- Standard swivel tilt
- Dual wheel carpet casters
- Seat: 20"W x 19"D x 17-20.5"H

OPTION	PRICE	CODE
Jury Base	315.00	JB
Knee Tilt Control	100.00	K
Edge Guard	16.00	E
CASTER	PRICE	CODE
Self-Locking Casters	85.00	S
Braking Casters	30.00	B
Hard-Floor Casters	19.00	H
Glides	N/C	GL

**QS**

**ALL FOAM & FABRICS USED ARE CAL 117 APPROVED**

**QS** indicates a Quickship item if ordered in Quickship upholstery. Quick Ship is not available on any item ordered with options.

# SCOOP SIN 711-18

## FINISH SELECTION

PEARWOOD **PW** | ROUGE MAHOGANY **RM** | MAHOGANY **MAH** | ASPEN **AP** | NATURAL **FM** | HONEY CHERRY **HCY** | WALNUT **WAL** | WINDSOR CHERRY **WC** | CLASSIC CHERRY **CCY** | ESPRESSO **ESP** | MEDIUM OAK **OAK** | NATURAL OAK **NOK** | BLACK **BLK**

CONTEMPORARY OFFICE

### 1111 Executive Swivel

25" W X 28.5" D X 37.40" H

St. Yardage: 3



Freight Class: 150  
Cubic Ft: 21  
Ship Weight: 49

Grade	1	2	3	4	5	6	7	8	9	10	L	LL
<b>Zone 1</b>	1009	1092	1115	1164	1213	1278	1303	1408	1474	1555	1710	2042
<b>Zone 2</b>	1024	1108	1132	1181	1231	1297	1323	1429	1496	1578	1736	2073
<b>Zone 3</b>	1039	1125	1148	1199	1249	1316	1342	1450	1518	1602	1761	2103

- Standard swivel tilt
- Channel style back
- Wood arms available in the finishes listed except OAK and NOK
- 5-prong steel base with hardwood caps and dual wheel casters
- Pneumatic seat-height adjustment
- Seat: 20"W x 19"D x 17-20.5"H

OPTION	PRICE	CODE
Knee Tilt Control	100.00	K
Edge Guard	16.00	E

CASTER	PRICE	CODE
Self-Locking Casters	85.00	S
Braking Casters	30.00	B
Hard-Floor Casters	19.00	H
Glides	N/C	GL

**QS**

### 1113 Arm Chair

24" W X 27" D X 33" H

St. Yardage: 2



Freight Class: 150  
Cubic Ft: 15  
Ship Weight: 31

Grade	1	2	3	4	5	6	7	8	9	10	L	LL
<b>Zone 1</b>	566	599	637	669	702	745	762	832	876	930	1033	1254
<b>Zone 2</b>	574	608	647	679	713	756	773	844	889	944	1048	1273
<b>Zone 3</b>	583	617	656	689	723	767	785	857	902	958	1064	1292

- Channel style back
- Wood arms/legs available in the finishes listed
- Gangable up to 4 chairs
- Seat: 20"W x 19"D x 18.5"H

**Note:** Add a "C" to the product number for each ganged chair, and multiply number of chairs by correct list price. Ex: 1113CCC (3 chairs)

**QS**

### 1114 Sled Base Arm Chair

24" W X 27" D X 33" H

St. Yardage: 2



Freight Class: 150  
Cubic Ft: 15  
Ship Weight: 33

Grade	1	2	3	4	5	6	7	8	9	10	L	LL
<b>Zone 1</b>	626	682	697	729	762	805	822	892	936	990	1093	1312
<b>Zone 2</b>	635	692	707	740	773	817	834	905	950	1005	1109	1332
<b>Zone 3</b>	645	702	718	751	785	829	847	919	964	1020	1126	1351

- Channel style back
- Wood arms and sled base
- Available in the finishes listed
- Gangable up to 4 chairs
- Price shown is per chair
- Seat: 20"W x 19"D x 18.5"H

**Note:** Add a "C" to the product number for each ganged chair, and multiply number of chairs by correct list price. Ex: 1114CCC (3 chairs)

**QS**

### 1117 Management Swivel

25" W X 27" D X 32-35" H

St. Yardage: 2



Freight Class: 150  
Cubic Ft: 19  
Ship Weight: 46

Grade	1	2	3	4	5	6	7	8	9	10	L	LL
<b>Zone 1</b>	864	923	935	967	1000	1043	1060	1130	1174	1228	1331	1552
<b>Zone 2</b>	877	937	949	982	1015	1059	1076	1147	1192	1246	1351	1575
<b>Zone 3</b>	890	951	963	996	1030	1074	1092	1164	1209	1265	1371	1599

- Channel style back
- Wood arms
- 5-prong steel base with hardwood caps and dual wheel casters
- Pneumatic seat-height adjustment
- Available in finishes listed except OAK and NOK
- Standard swivel tilt
- Seat: 20"W x 19"D x 17-20.5"H

OPTION	PRICE	CODE
Jury Base	315.00	JB
Knee Tilt Control	100.00	K
Edge Guard	16.00	E

CASTER	PRICE	CODE
Self-Locking Casters	85.00	S
Braking Casters	30.00	B
Hard-Floor Casters	19.00	H
Glides	N/C	GL

**QS**

## FINISH SELECTION

PEARWOOD **PW** | ROUGE MAHOGANY **RM** | MAHOGANY **MAH** | ASPEN **AP** | NATURAL **FM** |  
 HONEY CHERRY **HCY** | ESPRESSO **ESP** | MOAB **MOB** | MEDIUM OAK **OAK** | WALNUT **WAL** |  
 WINDSOR CHERRY **WC** | CLASSIC CHERRY **CCY** | NATURAL OAK **NOK** | BLACK **BLK**

SIN 711-18 **1200 SERIES**

CONTEMPORARY OFFICE

### Four Unique Designs

**1200 Series** office seating includes four unique contemporary seating designs ergonomically shaped for lumbar support, proper posture and long-term comfort.



1231 Executive

### Design Details

- **1210s**— dual-cushion appearance, wood arms, 5-prong steel base with hardwood caps
- **1220s**— thin profile, horizontal back stitching, black urethane arms/base, large scale
- **1230s**— polished chrome base with dual wheel casters, polished chrome arms with black urethane armcap, knee tilt standard
- **1240s**— thin profile with horizontal back stitching, wood arms with upholstered arm cap, 5-prong steel base with hardwood caps

### 1247 Management and 1241 Executive



## 1200 SERIES

### 1211 Executive Swivel

23" W X 28" D X 41-44" H

St. Yardage: 4.5



Freight Class: 150

Cubic Ft: 26

Ship Weight: 50

Grade	1	2	3	4	5	6	7	8	9	10	L	LL
Zone 1	1549	1622	1708	1781	1855	1953	1990	2148	2246	2368	2601	3084
Zone 2	1572	1646	1734	1808	1883	1982	2020	2180	2280	2404	2640	3130
Zone 3	1595	1671	1759	1834	1911	2012	2050	2212	2313	2439	2679	3177

- Wood arms
- 5-prong steel base with hardwood caps
- Pneumatic seat-height adjustment
- Standard swivel tilt
- Dual wheel carpet casters
- Seat: 19"W x 18"D x 18-21"H

OPTION	PRICE	CODE
Knee Tilt Control	100.00	K
Edge Guard	16.00	E
Upholstered Arm Caps	114.00	UA
CASTER	PRICE	CODE
Self-Locking Casters	85.00	S
Braking Casters	30.00	B
Hard-Floor Casters	19.00	H
Glides	N/C	GL

### QS

### 1217 Management Swivel

23" W X 27" D X 36-39" H

St. Yardage: 3.8



Freight Class: 150

Cubic Ft: 19

Ship Weight: 46

Grade	1	2	3	4	5	6	7	8	9	10	L	LL
Zone 1	1436	1498	1570	1632	1694	1777	1809	1942	2025	2128	2324	2703
Zone 2	1458	1520	1594	1656	1719	1804	1836	1971	2055	2160	2359	2744
Zone 3	1479	1543	1617	1681	1745	1830	1863	2000	2086	2192	2394	2784

- Wood arms
- 5-prong steel base with hardwood caps
- Standard swivel tilt
- Dual wheel carpet casters
- Pneumatic seat-height adjustment
- Available in the finishes above
- Seat: 19"W x 18"D x 18-21"H

OPTION	PRICE	CODE
Jury Base	315.00	JB
Knee Tilt Control	100.00	K
Edge Guard	16.00	E
Upholstered Arm Caps	114.00	UA
CASTER	PRICE	CODE
Self-Locking Casters	85.00	S
Braking Casters	30.00	B
Hard-Floor Casters	19.00	H
Glides	N/C	GL

### QS

ALL FOAM & FABRICS USED ARE CAL 117 APPROVED

**QS** indicates a Quickship item if ordered in Quickship upholstery. Quick Ship is not available on any item ordered with options.

# 1200 SERIES SIN 711-18

## FINISH SELECTION

PEARWOOD **PW** | ROUGE MAHOGANY **RM** | MAHOGANY **MAH** | ASPEN **AP** | NATURAL **FM**  
 | HONEY CHERRY **HCY** | ESPRESSO **ESP** | MOAB **MOB** | MEDIUM OAK **OAK** | WALNUT  
**WAL** | WINDSOR CHERRY **WC** | CLASSIC CHERRY **CCY** | NATURAL OAK **NOK** |

CONTEMPORARY OFFICE

### 1221 Executive Swivel

25" W X 29" D X 41-44" H

St. Yardage: 2.75



Freight Class: 150  
 Cubic Ft: 23  
 Ship Weight: 50

Grade	1	2	3	4	5	6	7	8	9	10	L	LL
<b>Zone 1</b>	1166	1259	1283	1341	1390	1462	1490	1605	1677	1767	1937	2257
<b>Zone 2</b>	1183	1278	1302	1361	1411	1484	1512	1629	1702	1794	1966	2291
<b>Zone 3</b>	1201	1297	1321	1381	1432	1506	1535	1653	1727	1820	1995	2325

- Black urethane arm
- Black nylon reinforced 5-prong base
- Pneumatic seat-height adjustment
- Standard swivel tilt
- Dual wheel carpet casters
- Seat: 20.25"W x 19.75"D x 18.5-22"H

OPTION	PRICE	CODE
Knee Tilt Control	100.00	K
Edge Guard	16.00	E

CASTER	PRICE	CODE
Self-Locking Casters	85.00	S
Braking Casters	30.00	B
Hard-Floor Casters	19.00	H
Glides	N/C	GL

**QS**

### 1227 Management Swivel

25" W X 27" D X 35-38" H

St. Yardage: 2.5



Freight Class: 150  
 Cubic Ft: 19  
 Ship Weight: 46

Grade	1	2	3	4	5	6	7	8	9	10	L	LL
<b>Zone 1</b>	1074	1146	1210	1244	1298	1319	1407	1461	1529	1658	1790	1920
<b>Zone 2</b>	1090	1163	1228	1263	1317	1339	1428	1483	1552	1683	1817	1949
<b>Zone 3</b>	1106	1180	1246	1281	1337	1359	1449	1505	1575	1708	1844	1978

- Black urethane arm
- Black nylon reinforced 5-prong base
- Pneumatic seat-height adjustment
- Standard swivel tilt
- Dual wheel carpet casters
- Seat: 20.25"W x 19.75"D x 18.5-22"H

OPTION	PRICE	CODE
Jury Base	315.00	JB
Knee Tilt Control	100.00	K
Edge Guard	16.00	E

CASTER	PRICE	CODE
Self-Locking Casters	85.00	S
Braking Casters	30.00	B
Hard-Floor Casters	19.00	H
Glides	N/C	GL

**QS**

### 1231 Executive Swivel

24.5" W X 27.5" D X 41-44" H

St. Yardage: 2.75



Freight Class: 150  
 Cubic Ft: 23  
 Ship Weight: 50

Grade	1	2	3	4	5	6	7	8	9	10	L	LL
<b>Zone 1</b>	1191	1292	1377	1429	1505	1534	1657	1733	1828	2009	2373	2437
<b>Zone 2</b>	1209	1311	1398	1450	1528	1557	1682	1759	1855	2039	2409	2474
<b>Zone 3</b>	1227	1331	1418	1472	1550	1580	1707	1785	1883	2069	2444	2510

- Polished chrome arms with black urethane arm caps
- Polished chrome base with dual wheel casters
- Knee tilt control standard (No additional control options on this model)
- Pneumatic seat-height adjustment
- Seat: 20"W x 20"D x 18.5-21.5"H

OPTION	PRICE	CODE
Edge Guard	16.00	E

CASTER	PRICE	CODE
Self-Locking Casters	85.00	S
Braking Casters	30.00	B
Hard-Floor Casters	19.00	H
Glides	N/C	GL

**QS**



# FINISH SELECTION

PEARWOOD **PW** | ROUGE MAHOGANY **RM** | MAHOGANY **MAH** | ASPEN **AP** | NATURAL **FM** | HONEY CHERRY **HCY** | ESPRESSO **ESP** | MOAB **MOB** | MEDIUM OAK **OAK** | WALNUT **WAL** | WINDSOR CHERRY **WC** | CLASSIC CHERRY **CCY** | NATURAL OAK **NOK** | BLACK **BLK** |

# SIN 711-18 1200 SERIES

CONTEMPORARY OFFICE

## 1237 Management Swivel

24.5" W X 26" D X 36-39" H

St. Yardage: 2.5



Freight Class: 150  
Cubic Ft: 19  
Ship Weight: 46

Grade	1	2	3	4	5	6	7	8	9	10	L	LL
<b>Zone 1</b>	1087	1172	1247	1291	1356	1381	1456	1552	1633	1788	2093	2155
<b>Zone 2</b>	1103	1190	1266	1310	1376	1402	1478	1575	1657	1815	2124	2187
<b>Zone 3</b>	1120	1207	1284	1330	1397	1422	1500	1599	1682	1842	2156	2220

- Polished chrome arms with black urethane arm caps
- Polished chrome base with dual wheel casters
- Knee tilt control standard (No additional control options on this model)
- Pneumatic seat-height adjustment
- Seat: 20"W x 20"D x 18.5-21.5"H

OPTION	PRICE	CODE
Jury Base	315.00	JB
Edge Guard	16.00	E
CASTER	PRICE	CODE
Self-Locking Casters	85.00	S
Braking Casters	30.00	B
Hard-Floor Casters	19.00	H
Glides	N/C	GL

**QS**

## 1241 Executive Swivel

24" W X 28" D X 42-46" H

St. Yardage: 2.75



Freight Class: 150  
Cubic Ft: 26  
Ship Weight: 50

Grade	1	2	3	4	5	6	7	8	9	10	L	LL
<b>Zone 1</b>	1028	1128	1219	1266	1342	1371	1494	1570	1665	1846	2261	2474
<b>Zone 2</b>	1043	1145	1237	1285	1362	1392	1516	1594	1690	1874	2295	2511
<b>Zone 3</b>	1059	1162	1256	1304	1382	1412	1539	1617	1715	1901	2329	2548

- Wood arms
- 5-prong steel base with hardwood caps
- Pneumatic seat-height adjustment
- Standard swivel tilt
- Dual wheel carpet casters
- Seat: 19"W x 18"D x 18-21"H

OPTION	PRICE	CODE
Knee Tilt Control	100.00	K
Edge Guard	16.00	E
CASTER	PRICE	CODE
Self-Locking Casters	85.00	S
Braking Casters	30.00	B
Hard-Floor Casters	19.00	H
Glides	N/C	GL

**QS**

## 1247 Management Swivel

24" W X 26" D X 34-38" H

St. Yardage: 2.5



Freight Class: 150  
Cubic Ft: 26  
Ship Weight: 50

Grade	1	2	3	4	5	6	7	8	9	10	L	LL
<b>Zone 1</b>	984	1076	1148	1188	1253	1278	1353	1449	1530	1685	2046	2152
<b>Zone 2</b>	999	1092	1165	1206	1272	1297	1373	1471	1553	1710	2077	2184
<b>Zone 3</b>	1014	1108	1182	1224	1291	1316	1394	1492	1576	1736	2107	2217

- Wood arms with upholstered arm caps
- 5-prong steel base with hardwood caps
- Dual wheel casters
- Pneumatic seat-height adjustment
- Standard swivel tilt
- Available in the finishes above
- Seat: 19"W x 19"D x 17.5-21"H

OPTION	PRICE	CODE
Jury Base	315.00	JB
Knee Tilt Control	100.00	K
Edge Guard	16.00	E
CASTER	PRICE	CODE
Self-Locking Casters	85.00	S
Braking Casters	30.00	B
Hard-Floor Casters	19.00	H
Glides	N/C	GL

**QS**

ALL FOAM & FABRICS USED ARE CAL 117 APPROVED

**QS** indicates a Quickship item if ordered in Quickship upholstery. Quick Ship is not available on any item ordered with options.

# TRIFECTA SIN 711-18

## FINISH SELECTION

ASPEN **AP** | ROUGE MAHOGANY **RM** | MAHOGANY **MAH** | NATURAL **FM** | HONEY  
 CHERRY **HCY** | ESPRESSO **ESP** | PEARWOOD **PW** | MOAB **MOB** | BLACK **BLK** | WALNUT  
**WAL** | WINDSOR CHERRY **WC** | CLASSIC CHERRY **CCY** |

CONTEMPORARY OFFICE

### Three Winning Designs

**Trifecta 1600 Series** presents executive-level style, comfort and value in three distinct arm designs: Fully Upholstered, Wood Arms/Base and Black Textured Resin Arms/Base.

### Design Details

- *Pronounced backrest and lumbar support enhance comfort*
- *Seats feature thick, multi-density foam and seat suspensions that conform to the individual*
- *Waterfall front seat edges provide proper leg support*

### Additional Information

- *Quick Ship available in 60+ upholsteries*
- *Limited Lifetime Warranty on all chairs*



1621 Executive



1627 Management



1641 Executive



1661 Executive

## TRIFECTA

### 1621 Executive Swivel

24" W X 30" D X 44-48" H

St. Yardage: 4



Freight Class: 150  
 Cubic Ft: 24  
 Ship Weight: 56

Grade	1	2	3	4	5	6	7	8	9	10	L	LL
Zone 1	1146	1254	1347	1401	1482	1514	1645	1727	1829	1979	2022	2423
Zone 2	1163	1273	1367	1422	1504	1537	1670	1753	1856	2009	2052	2459
Zone 3	1180	1292	1387	1443	1526	1559	1694	1779	1884	2038	2083	2496

- Wood arms
- 5-prong steel base with hardwood caps
- Pneumatic seat-height adjustment
- Standard swivel tilt
- Dual wheel casters
- Seat: 19"W x 18"D x 18.5-22.5"H

OPTION	PRICE	CODE
Knee Tilt Control	100.00	K
Edge Guard	16.00	E

CASTER	PRICE	CODE
Self-Locking Casters	85.00	S
Braking Casters	30.00	B
Hard-Floor Casters	19.00	H
Glides	N/C	GL

### QS

### 1624 Side Chair

24" W X 27" D X 34" H

St. Yardage: 3.25



Freight Class: 150  
 Cubic Ft: 14  
 Ship Weight: 29

Grade	1	2	3	4	5	6	7	8	9	10	L	LL
Zone 1	962	1012	1069	1130	1183	1253	1281	1395	1465	1554	1678	1822
Zone 2	976	1027	1085	1147	1201	1272	1300	1416	1487	1577	1703	1849
Zone 3	991	1042	1101	1164	1218	1291	1319	1437	1509	1601	1728	1877

- Wood arms/base
- Thick cushioned backrest with built in lumbar support
- Seat: 19"W x 18"D x 18.5"H

### QS

# FINISH SELECTION

ASPEN **AP** | ROUGE MAHOGANY **RM** | MAHOGANY **MAH** | NATURAL **FM** | HONEY  
 CHERRY **HCY** | ESPRESSO **ESP** | PEARWOOD **PW** | MOAB **MOB** | BLACK **BLK** | WALNUT  
 WAL | WINDSOR CHERRY **WC** | CLASSIC CHERRY **CCY** |

SIN 711-18 **TRIFECTA**

CONTEMPORARY OFFICE

## 1627 Management Swivel

24" W X 28" D X 34-38" H

St. Yardage: 4



Freight Class: 150  
 Cubic Ft: 19  
 Ship Weight: 45

Grade	1	2	3	4	5	6	7	8	9	10	L	LL
Zone 1	1055	1146	1230	1276	1346	1374	1428	1488	1558	1647	1815	2162
Zone 2	1071	1163	1248	1295	1366	1395	1449	1510	1581	1672	1842	2194
Zone 3	1087	1180	1267	1314	1386	1415	1471	1533	1605	1696	1869	2227

- Wood arms
- 5-prong steel base with hardwood caps
- Pneumatic seat-height adjustment
- Standard swivel tilt
- Dual wheel casters
- Seat: 19"W x 18"D x 18.5-22.5"H

OPTION	PRICE	CODE
Jury Base	315.00	JB
Knee Tilt Control	100.00	K
Edge Guard	16.00	E

CASTER	PRICE	CODE
Self-Locking Casters	85.00	S
Braking Casters	30.00	B
Hard-Floor Casters	19.00	H
Glides	N/C	GL

**QS**

## 1641 Executive Swivel

26.5" W X 30" D X 44-48" H

St. Yardage: 5



Freight Class: 150  
 Cubic Ft: 24  
 Ship Weight: 65

Grade	1	2	3	4	5	6	7	8	9	10	L	LL
Zone 1	1295	1437	1561	1635	1743	1785	1873	1961	2069	2205	2463	2997
Zone 2	1314	1459	1584	1660	1769	1812	1901	1990	2100	2238	2500	3042
Zone 3	1334	1480	1608	1684	1795	1839	1929	2020	2131	2271	2537	3087

- Upholstered arms
- 5-prong steel base with hardwood caps
- Pneumatic seat-height adjustment
- Standard swivel tilt
- Dual wheel casters
- Seat: 19"W x 18"D x 18.5-22.5"H

OPTION	PRICE	CODE
Knee Tilt Control	100.00	K
Edge Guard	16.00	E

CASTER	PRICE	CODE
Self-Locking Casters	85.00	S
Braking Casters	30.00	B
Hard-Floor Casters	19.00	H
Glides	N/C	GL

**QS**

## 1647 Management Swivel

26.5" W X 28" D X 34-38" H

St. Yardage: 4.5



Freight Class: 150  
 Cubic Ft: 19  
 Ship Weight: 55

Grade	1	2	3	4	5	6	7	8	9	10	L	LL
Zone 1	1211	1338	1452	1517	1566	1615	1652	1810	1908	2030	2263	2738
Zone 2	1229	1358	1474	1540	1589	1639	1677	1837	1937	2060	2297	2779
Zone 3	1247	1378	1496	1563	1613	1663	1702	1864	1965	2091	2331	2820

- Upholstered arms
- 5-prong steel base with hardwood caps
- Pneumatic seat-height adjustment
- Standard swivel tilt
- Dual wheel casters
- Seat: 19"W x 18"D x 18.5-22.5"H

OPTION	PRICE	CODE
Jury Base	315.00	JB
Knee Tilt Control	100.00	K
Edge Guard	16.00	E

CASTER	PRICE	CODE
Self-Locking Casters	85.00	S
Braking Casters	30.00	B
Hard-Floor Casters	19.00	H
Glides	N/C	GL

**QS**

ALL FOAM & FABRICS USED ARE CAL 117 APPROVED

**QS** indicates a Quickship item if ordered in Quickship upholstery. Quick Ship is not available on any item ordered with options.

# TRIFECTA SIN 711-18

## FINISH SELECTION

ASPEN **AP** | ROUGE MAHOGANY **RM** | MAHOGANY **MAH** | NATURAL **FM** | HONEY CHERRY **HCY** | ESPRESSO **ESP** | PEARWOOD **PW** | MOAB **MOB** | BLACK **BLK** | WALNUT **WAL** | WINDSOR CHERRY **WC** | CLASSIC CHERRY **CCY** |

CONTEMPORARY OFFICE

### 1661 Executive Swivel

24" W X 30" D X 44-48" H

St. Yardage: 4



Freight Class: 150  
Cubic Ft: 24  
Ship Weight: 54

Grade	1	2	3	4	5	6	7	8	9	10	L	LL
Zone 1	1146	1254	1347	1401	1482	1514	1579	1645	1727	1829	2122	2423
Zone 2	1163	1273	1367	1422	1504	1537	1603	1670	1753	1856	2154	2459
Zone 3	1180	1292	1387	1443	1526	1559	1626	1694	1779	1884	2186	2496

- Black urethane arms
- Black nylon reinforced 5-prong base
- Pneumatic seat-height adjustment
- Standard swivel tilt
- Dual wheel casters
- Seat: 19"W x 18"D x 18.5-22.5"H

OPTION	PRICE	CODE
Knee Tilt Control	100.00	K
Edge Guard	16.00	E

CASTER	PRICE	CODE
Self-Locking Casters	85.00	S
Braking Casters	30.00	B
Hard-Floor Casters	19.00	H
Glides	N/C	GL

**QS**

### 1667 Management Swivel

24" W X 28" D X 34-38" H

St. Yardage: 4



Freight Class: 150  
Cubic Ft: 19  
Ship Weight: 45

Grade	1	2	3	4	5	6	7	8	9	10	L	LL
Zone 1	1055	1146	1230	1276	1346	1374	1431	1488	1558	1647	1915	2162
Zone 2	1071	1163	1248	1295	1366	1395	1452	1510	1581	1672	1944	2194
Zone 3	1087	1180	1267	1314	1386	1415	1474	1533	1605	1696	1972	2227

- Black urethane arms
- Black nylon reinforced 5-prong base
- Pneumatic seat-height adjustment
- Standard swivel tilt
- Dual wheel casters
- Seat: 19"W x 18"D x 18.5-22.5"H

OPTION	PRICE	CODE
Jury Base	315.00	JB
Knee Tilt Control	100.00	K
Edge Guard	16.00	E

CASTER	PRICE	CODE
Self-Locking Casters	85.00	S
Braking Casters	30.00	B
Hard-Floor Casters	19.00	H
Glides	N/C	GL

**QS**

# FINISH SELECTION

ASPEN **AP** | ROUGE MAHOGANY **RM** | MAHOGANY **MAH** | NATURAL **FM** | HONEY CHERRY **HCY** | ESPRESSO **ESP** | PEARWOOD **PW** | MOAB **MOB** | BLACK **BLK** | WALNUT **WAL** | WINDSOR CHERRY **WC** | CLASSIC CHERRY **CCY** | NATURAL OAK **NOK** | MEDIUM OAK **OAK** |

# SIN 711-18 QUICK SILVER

CONTEMPORARY OFFICE

## Four Designs, One Ergonomic Comfort

**Quick Silver** begins with an ergonomically shaped lumbar design, contoured to promote proper posture for comfort and long-term back support. Waterfall front seat edges provide freedom of movement and reduce stress on legs. All four Quick Silver designs incorporate these features in Executive, Management and Guest chair selections. Guest seating is also available.

## Design Details

- **1270s** – double trapezoid back stitching; upholstered arm caps on wood arms
- **1830s** – horizontal back stitching; all-wood arms
- **3200s** – flared vertical back stitching; upholstered arm caps on wood arms; swivel chairs also available with black base and arms

## Additional Features

- Pneumatic seat-height adjustment standard
- Tilt-tension adjustment standard
- Extensive Standard & Quick Ship Upholsteries
- Limited Lifetime Warranty



1271 Executive



1831 Executive



3271 Executive

## Quick Silver

### 1271 Executive Swivel

24" W X 28" D X 42-46" H

St. Yardage: 3



Freight Class: 150  
Cubic Ft: 23  
Ship Weight: 59

Grade	1	2	3	4	5	6	7	8	9	10	L	LL
Zone 1	986	1081	1156	1207	1277	1305	1362	1419	1489	1578	1946	2091
Zone 2	1001	1097	1173	1225	1296	1325	1382	1440	1511	1602	1975	2122
Zone 3	1016	1113	1191	1243	1315	1344	1403	1462	1534	1625	2004	2154

- Wood arms with upholstered arm caps
- 5-prong steel base with hardwood caps
- Dual wheel casters
- Pneumatic seat-height adjustment
- Standard swivel tilt
- Seat: 19.5"W x 18.75"D x 17-20.5"H

OPTION	PRICE	CODE
Knee Tilt Control	100.00	K
Edge Guard	16.00	E
CASTER	PRICE	CODE
Self-Locking Casters	85.00	S
Braking Casters	30.00	B
Hard-Floor Casters	19.00	H
Glides	N/C	GL

## QS

### 1274 Management Swivel

24" W X 26" D X 33" H St. Yardage: 2.5



Freight Class: 150  
Cubic Ft: 14  
Ship Weight: 29

Grade	1	2	3	4	5	6	7	8	9	10	L	LL
Zone 1	818	856	900	947	988	1042	1063	1151	1205	1273	1368	1558
Zone 2	830	869	914	961	1003	1058	1079	1168	1223	1292	1389	1581
Zone 3	843	882	927	975	1018	1073	1095	1186	1241	1311	1409	1605

- Wood arms/base
- Double trapezoid back stitching
- Seat: 19.5"W x 18"D x 18.5"H

## QS

### 1277 Management Swivel

24" W X 26" D X 34-38" H

St. Yardage: 2.5



Freight Class: 150  
Cubic Ft: 19  
Ship Weight: 51

Grade	1	2	3	4	5	6	7	8	9	10	L	LL
Zone 1	945	1016	1081	1115	1169	1190	1238	1278	1332	1400	1795	1935
Zone 2	959	1031	1097	1132	1187	1208	1257	1297	1352	1421	1822	1964
Zone 3	973	1046	1113	1148	1204	1226	1275	1316	1372	1442	1849	1993

- Wood arms with upholstered arm caps
- 5-prong steel base with wood caps
- Dual wheel casters
- Pneumatic seat-height adjustment
- Standard swivel tilt
- Seat: 19.5"W x 18.75"D x 17-20.5"H

OPTION	PRICE	CODE
Jury Base	315.00	JB
Knee Tilt Control	100.00	K
Edge Guard	16.00	E
CASTER	PRICE	CODE
Self-Locking Casters	85.00	S
Braking Casters	30.00	B
Hard-Floor Casters	19.00	H
Glides	N/C	GL

## QS

ALL FOAM & FABRICS USED ARE CAL 117 APPROVED

**QS** indicates a Quickship item if ordered in Quickship upholstery. Quick Ship is not available on any item ordered with options.

# QUICK SILVER SIN 711-18

## FINISH SELECTION

ASPEN **AP** | ROUGE MAHOGANY **RM** | MAHOGANY **MAH** | NATURAL **FM** | HONEY CHERRY **HCY** | ESPRESSO **ESP** | PEARWOOD **PW** | MOAB **MOB** | BLACK **BLK** | WALNUT **WAL** | WINDSOR CHERRY **WC** | CLASSIC CHERRY **CCY** | NATURAL OAK **NOK** | MEDIUM OAK **OAK** |

CONTEMPORARY OFFICE

### 1831 Executive Swivel

25" W X 28" D X 41-44.5" H

St. Yardage: 3



Freight Class: 150  
Cubic Ft: 23  
Ship Weight: 55

Grade	1	2	3	4	5	6	7	8	9	10	L	LL
Zone 1	986	1081	1156	1207	1277	1305	1362	1419	1489	1578	1946	2091
Zone 2	1001	1097	1173	1225	1296	1325	1382	1440	1511	1602	1975	2122
Zone 3	1016	1113	1191	1243	1315	1344	1403	1462	1534	1625	2004	2154

- Wood arms
- 5-prong steel base with hardwood caps Dual wheel casters
- Pneumatic seat-height adjustment
- Standard swivel tilt
- Available in the finishes listed above except OAK and NOK
- Seat: 19.5"W x 18.75"D x 17.5-21"H

OPTION	PRICE	CODE
Knee Tilt Control	100.00	K
Edge Guard	16.00	E
CASTER	PRICE	CODE
Self-Locking Casters	85.00	S
Braking Casters	30.00	B
Hard-Floor Casters	19.00	H
Glides	N/C	GL

**QS**

### 1834 Side Chair

24" W X 26" D X 33" H

St. Yardage: 2.5



Freight Class: 150  
Cubic Ft: 14  
Ship Weight: 28

Grade	1	2	3	4	5	6	7	8	9	10	L	LL
Zone 1	864	913	971	993	1034	1088	1109	1197	1251	1319	1580	1754
Zone 2	877	927	986	1008	1050	1104	1126	1215	1270	1339	1604	1780
Zone 3	890	940	1000	1023	1065	1121	1142	1233	1289	1359	1627	1807

- Wood arms/legs
- Horizontal back stitching
- Seat: 19.5"W x 18.75"D x 18.5"H

**QS**

### 1837 Management Swivel

25" W X 26" D X 34-38" H

St. Yardage: 2.5



Freight Class: 150  
Cubic Ft: 19  
Ship Weight: 51

Grade	1	2	3	4	5	6	7	8	9	10	L	LL
Zone 1	945	1016	1081	1115	1169	1190	1238	1278	1332	1400	1795	1935
Zone 2	959	1031	1097	1132	1187	1208	1257	1297	1352	1421	1822	1964
Zone 3	973	1046	1113	1148	1204	1226	1275	1316	1372	1442	1849	1993

- Wood arms
- 5-prong steel base with hardwood caps
- Dual wheel casters
- Pneumatic seat-height adjustment
- Standard swivel tilt
- Available in the finishes listed above except OAK and NOK
- Seat: 19.5" W x 18.75" D x 17.5-21" H

OPTION	PRICE	CODE
Jury Base	315.00	JB
Knee Tilt Control	100.00	K
Edge Guard	16.00	E
CASTER	PRICE	CODE
Self-Locking Casters	85.00	S
Braking Casters	30.00	B
Hard-Floor Casters	19.00	H
Glides	N/C	GL

**QS**

### 3271 Executive Swivel

24" W X 28" D X 41-44.5" H

St. Yardage: 3



Freight Class: 150  
Cubic Ft: 23  
Ship Weight: 55

Grade	1	2	3	4	5	6	7	8	9	10	L	LL
Zone 1	1006	1102	1178	1227	1297	1325	1379	1449	1509	1598	1766	2132
Zone 2	1021	1119	1196	1245	1316	1345	1400	1471	1532	1622	1792	2164
Zone 3	1036	1135	1213	1264	1336	1365	1420	1492	1554	1646	1819	2196

- Wood arms with upholstered arm caps
- 5-prong steel base with hardwood caps
- Pneumatic seat-height adjustment
- Standard swivel tilt
- Seat: 19.5"W x 18.75"D x 16-19.75"H

OPTION	PRICE	CODE
Knee Tilt Control	100.00	K
Edge Guard	16.00	E
CASTER	PRICE	CODE
Self-Locking Casters	85.00	S
Braking Casters	30.00	B
Hard-Floor Casters	19.00	H
Glides	N/C	GL

**QS**



# FINISH SELECTION

ASPEN **AP** | ROUGE MAHOGANY **RM** | MAHOGANY **MAH** | NATURAL **FM** | HONEY CHERRY **HCY** | ESPRESSO **ESP** | PEARWOOD **PW** | MOAB **MOB** | BLACK **BLK** | WALNUT **WAL** | WINDSOR CHERRY **WC** | CLASSIC CHERRY **CCY** | NATURAL OAK **NOK** | MEDIUM OAK **OAK** |

# SIN 711-18 QUICK SILVER

CONTEMPORARY OFFICE

## 3274 Side Chair

24" W X 26" D X 33" H St. Yardage: 2.5



Freight Class: 150  
Cubic Ft: 14  
Ship Weight: 29

Grade	1	2	3	4	5	6	7	8	9	10	L	LL
Zone 1	880	930	987	1009	1050	1104	1125	1213	1267	1335	1596	1770
Zone 2	893	944	1002	1024	1066	1121	1142	1231	1286	1355	1620	1797
Zone 3	906	958	1017	1039	1082	1137	1159	1249	1305	1375	1644	1823

- Wood arms/legs
- Flared back stitching
- Seat: 19.5"W x 18.75"D x 18.5"H

**QS**

## 3277 Management Swivel

24" W X 26" D X 32-36" H St. Yardage: 2.5



Freight Class: 150  
Cubic Ft: 19  
Ship Weight: 51

Grade	1	2	3	4	5	6	7	8	9	10	L	LL
Zone 1	965	1035	1102	1145	1189	1210	1254	1298	1352	1420	1649	1831
Zone 2	979	1051	1119	1162	1207	1228	1273	1317	1372	1441	1674	1858
Zone 3	994	1066	1135	1179	1225	1246	1292	1337	1393	1463	1698	1886

- Wood arms with upholstered arm caps
- Pneumatic seat-height adjustment
- 5-prong steel base with hardwood caps
- Standard swivel tilt
- Seat: 19.5"W x 18.75"D x 16-19.75"H

OPTION	PRICE	CODE
Jury Base	315.00	JB
Knee Tilt Control	100.00	K
Edge Guard	16.00	E
CASTER	PRICE	CODE
Self-Locking Casters	85.00	S
Braking Casters	30.00	B
Hard-Floor Casters	19.00	H
Glides	N/C	GL

**QS**

## 3201 Executive Swivel

25" W X 28" D X 41-44.5" H St. Yardage: 3



Freight Class: 150  
Cubic Ft: 23  
Ship Weight: 55

Grade	1	2	3	4	5	6	7	8	9	10	L	LL
Zone 1	1006	1102	1178	1227	1297	1325	1379	1449	1509	1598	1766	2132
Zone 2	1021	1119	1196	1245	1316	1345	1400	1471	1532	1622	1792	2164
Zone 3	1036	1135	1213	1264	1336	1365	1420	1492	1554	1646	1819	2196

- Black urethane arms
- Black nylon reinforced 5-prong base
- Pneumatic seat-height adjustment
- Standard swivel tilt
- Seat: 19.5"W x 18.75"D x 16-19.75"H

OPTION	PRICE	CODE
Knee Tilt Control	100.00	K
Edge Guard	16.00	E
CASTER	PRICE	CODE
Self-Locking Casters	85.00	S
Braking Casters	30.00	B
Hard-Floor Casters	19.00	H
Glides	N/C	GL

**QS**

## 3207 Management Swivel

25" W X 26" D X 32-36" H St. Yardage: 2.5



Freight Class: 150  
Cubic Ft: 19  
Ship Weight: 51

Grade	1	2	3	4	5	6	7	8	9	10	L	LL
Zone 1	965	1035	1102	1145	1189	1210	1254	1298	1352	1420	1649	1831
Zone 2	979	1051	1119	1162	1207	1228	1273	1317	1372	1441	1674	1858
Zone 3	994	1066	1135	1179	1225	1246	1292	1337	1393	1463	1698	1886

- Black urethane arms
- Black nylon reinforced 5-prong base
- Pneumatic seat height adjustment
- Standard swivel tilt
- Seat: 19.5"W x 18.75"D x 16-19.75"H

OPTION	PRICE	CODE
Jury Base	315.00	JB
Knee Tilt Control	100.00	K
Edge Guard	16.00	E
CASTER	PRICE	CODE
Self-Locking Casters	85.00	S
Braking Casters	30.00	B
Hard-Floor Casters	19.00	H
Glides	N/C	GL

**QS**

ALL FOAM & FABRICS USED ARE CAL 117 APPROVED

**QS** indicates a Quickship item if ordered in Quickship upholstery. Quick Ship is not available on any item ordered with options.

# 3900 SERIES SIN 711-18

## FINISH SELECTION

ASPEN **AP** | ROUGE MAHOGANY **RM** | MAHOGANY **MAH** | NATURAL **FM** | HONEY CHERRY **HCY** | ESPRESSO **ESP** | PEARWOOD **PW** | MOAB **MOB** | BLACK **BLK** | WALNUT **WAL** | WINDSOR CHERRY **WC** | CLASSIC CHERRY **CCY** | NATURAL OAK **NOK** | MEDIUM OAK **OAK** |

CONTEMPORARY OFFICE

### Generous Proportions

**3900 Series** full-size contemporary executive seating features extended seat width and seat depth with contoured lumbar support for increased comfort. Generously proportioned, 3900 includes executive and management height models with wood arms and upholstered accent or with pliable, durable black urethane arms.

### Design Details

- Wood arm chairs available in all finishes
- All chairs feature pillow cushioning for soft, plush comfort
- Front seat edges provide proper leg support

### Additional Features

- Pneumatic seat-height adjustment standard
- Tilt-tension adjustment standard
- Optional knee tilt control
- Extensive Standard & Quick Ship upholsteries
- Limited Lifetime Warranty



Management 3907



Executive 3901



Executive 3921

## 3900 Series

### 3901 Executive Swivel

25.25" W X 30" D X 44-48" H

St. Yardage: 4.25



Freight Class: 150  
Cubic Ft: 19  
Ship Weight: 51

Grade	1	2	3	4	5	6	7	8	9	10	L	LL
Zone 1	1139	1251	1363	1445	1543	1580	1738	1836	1958	2191	2491	2654
Zone 2	1156	1270	1383	1467	1566	1604	1764	1864	1987	2224	2528	2694
Zone 3	1173	1289	1404	1488	1589	1627	1790	1891	2017	2257	2566	2734

- Oversized seat and back
- Wood arms with upholstered accent
- 5-prong steel base with hardwood caps
- Standard swivel tilt
- See series overview above
- Seat: 21"W x 20.5"D x 18.25-22.25"H

OPTION	PRICE	CODE
Knee Tilt Control	100.00	K
Edge Guard	16.00	E

CASTER	PRICE	CODE
Self-Locking Casters	85.00	S
Braking Casters	30.00	B
Hard-Floor Casters	19.00	H
Glides	N/C	GL

QS

### 3904 Side Chair

25.25" W X 30" D X 33" H

St. Yardage: 3.75



Freight Class: 150  
Cubic Ft: 15  
Ship Weight: 33

Grade	1	2	3	4	5	6	7	8	9	10	L	LL
Zone 1	1024	1073	1131	1243	1313	1405	1441	1590	1682	1798	2017	2237
Zone 2	1039	1089	1148	1262	1333	1426	1463	1614	1707	1825	2047	2271
Zone 3	1055	1105	1165	1280	1352	1447	1484	1638	1732	1852	2078	2304

- Oversized seat and back
- Pillow cushion comfort
- Wood arms/legs
- Seat: 21"W x 20.5"D x 18.5"H

QS

ALL FOAM & FABRICS USED ARE CAL 117 APPROVED

**QS** indicates a Quickship item if ordered in Quickship upholstery. Quick Ship is not available on any item ordered with options.

# FINISH SELECTION

ASPEN **AP** | ROUGE MAHOGANY **RM** | MAHOGANY **MAH** | NATURAL **FM** | HONEY CHERRY **HCY** | ESPRESSO **ESP** | PEARWOOD **PW** | MOAB **MOB** | BLACK **BLK** | WALNUT **WAL** | WINDSOR CHERRY **WC** | CLASSIC CHERRY **CCY** | NATURAL OAK **NOK** | MEDIUM OAK **OAK** |

# SIN 711-18 3900 SERIES

## 3907 Management Swivel

25.25" W X 30" D X 37.5-41.5" H St. Yardage: 4.25



Freight Class: 150  
Cubic Ft: 19  
Ship Weight: 51

Grade	1	2	3	4	5	6	7	8	9	10	L	LL
Zone 1	1111	1210	1316	1360	1400	1492	1528	1677	1769	1885	2304	2537
Zone 2	1128	1228	1336	1380	1421	1514	1551	1702	1796	1913	2339	2575
Zone 3	1144	1246	1355	1401	1442	1537	1574	1727	1822	1942	2373	2613

- Oversized seat and back
- Wood arms with upholstered accent
- 5-prong steel base with hardwood caps
- Standard swivel tilt
- See series overview above
- Seat: 21"W x 20.5"D x 18.25-22.25"H

OPTION	PRICE	CODE
Jury Base	315.00	JB
Knee Tilt Control	100.00	K
Edge Guard	16.00	E

CASTER	PRICE	CODE
Self-Locking Casters	85.00	S
Braking Casters	30.00	B
Hard-Floor Casters	19.00	H
Glides	N/C	GL

**QS**

## 3921 Executive Swivel

25.25" W X 30" D X 44-48" H St. Yardage: 4.5



Freight Class: 150  
Cubic Ft: 23  
Ship Weight: 55

Grade	1	2	3	4	5	6	7	8	9	10	L	LL
Zone 1	1139	1251	1363	1445	1494	1543	1580	1738	1836	1958	2191	2654
Zone 2	1156	1270	1383	1467	1516	1566	1604	1764	1864	1987	2224	2694
Zone 3	1173	1289	1404	1488	1539	1589	1627	1790	1891	2017	2257	2734

- Black urethane arms
- Black 5-prong nylon reinforced base
- Oversized seat and back
- Standard swivel tilt
- Seat: 21"W x 20.5"D x 18.25-22.25"H

OPTION	PRICE	CODE
Knee Tilt Control	100.00	K
Edge Guard	16.00	E

CASTER	PRICE	CODE
Self-Locking Casters	85.00	S
Braking Casters	30.00	B
Hard-Floor Casters	19.00	H
Glides	N/C	GL

**QS**

## 3927 Management Swivel

25.25" W X 30" D X 37.5-41.5" H St. Yardage: 4.25



Freight Class: 150  
Cubic Ft: 19  
Ship Weight: 50

Grade	1	2	3	4	5	6	7	8	9	10	L	LL
Zone 1	1090	1210	1316	1379	1425	1471	1507	1656	1748	1864	2383	2537
Zone 2	1106	1228	1336	1400	1446	1493	1530	1681	1774	1892	2419	2575
Zone 3	1123	1246	1355	1420	1468	1515	1552	1706	1800	1920	2454	2613

- Black urethane arms
- Black 5-prong nylon reinforced base
- Dual wheel casters
- Oversized seat and back
- Pillow cushion comfort
- Standard swivel tilt
- Seat: 21"W x 20.5"D x 18.25-22.25"H

OPTION	PRICE	CODE
Jury Base	315.00	JB
Knee Tilt Control	100.00	K
Edge Guard	16.00	E

CASTER	PRICE	CODE
Self-Locking Casters	85.00	S
Braking Casters	30.00	B
Hard-Floor Casters	19.00	H
Glides	N/C	GL

**QS**

ALL FOAM & FABRICS USED ARE CAL 117 APPROVED

**QS** indicates a Quickship item if ordered in Quickship upholstery. Quick Ship is not available on any item ordered with options.

CONTEMPORARY OFFICE

# CONTEMPO ARMLESS SIN 711-18

## FINISH SELECTION

ASPEN **AP** | BLACK **BLK** | NATURAL **FM** | HONEY CHERRY **HCY** | ROUGE  
 MAHOGANY **RM** | MAHOGANY **MAH** | MOAB **MOB** | PEARWOOD **PW** | WALNUT  
 WAL | WINDSOR CHERRY **WC** | CLASSIC CHERRY **CCY** | ESPRESSO **ESP** |

GUEST

### Design Flexibility with Armless Seating

Contempo presents elegant wood guest seating with extensive design flexibility. Solid hardwood frames offer the unique characteristics of wood. Select from four precision cut, multiple-layer hardwood plywood back designs known as Hourglass, Fan, Ladder and Puzzle.

### Contempo Features

- *Armless*
- *6 back designs: hourglass, fan, ladder, puzzle, upholstered and partial upholstered backs*
- *Suspended, improved-cushioning seats*
- *Multiple-density foam*



9500 Upholstered Back



9400 Hourglass Back

## CONTEMPO ARMLESS

### 9400 Hourglass Back Chair

20" W X 22" D X 34" H

St. Yardage: 1



FREIGHT CLASS: 250  
 CUBIC FT: 15  
 SHIP WEIGHT: 31

Grade	1	2	3	4	5	6	7	8	9	10	L	LL
Zone 1	737	772	803	822	849	860	881	903	931	965	1029	1162
Zone 2	748	784	815	834	862	873	894	917	945	979	1044	1179
Zone 3	759	795	827	847	874	886	907	930	959	994	1060	1197

- Solid hardwood frame
- Hourglass wood back
- Cross rails for added leg support

• Seat: 18.75"W x 18.75"D x 19"H

OPTION	PRICE	CODE
Casters for Guest Chairs	50.00	C

QS

### 9410 Fan Back Chair

20" W X 22" D X 34" H

St. Yardage: 1



FREIGHT CLASS: 250  
 CUBIC FT: 15  
 SHIP WEIGHT: 31

Grade	1	2	3	4	5	6	7	8	9	10	L	LL
Zone 1	737	772	803	822	849	860	881	903	931	965	1029	1162
Zone 2	748	784	815	834	862	873	894	917	945	979	1044	1179
Zone 3	759	795	827	847	874	886	907	930	959	994	1060	1197

- Solid hardwood frame
- Fan wood back
- Cross rails for added leg support

• Seat: 18.75"W x 18.75"D x 19"H

OPTION	PRICE	CODE
Casters for Guest Chairs	50.00	C

QS

### 9420 Ladder Back Chair

20" W X 22" D X 34" H

St. Yardage: 1



FREIGHT CLASS: 250  
 CUBIC FT: 15  
 SHIP WEIGHT: 31

Grade	1	2	3	4	5	6	7	8	9	10	L	LL
Zone 1	737	772	803	822	849	860	881	903	931	965	1029	1162
Zone 2	748	784	815	834	862	873	894	917	945	979	1044	1179
Zone 3	759	795	827	847	874	886	907	930	959	994	1060	1197

- Solid hardwood frame
- Ladder wood back
- Cross rails for added leg support

• Seat: 18.75"W x 18.75"D x 19"H

OPTION	PRICE	CODE
Casters for Guest Chairs	50.00	C

QS

FINISH SELECTION

ASPEN **AP** | BLACK **BLK** | NATURAL **FM** | HONEY CHERRY **HCY** | ROUGE MAHOGANY **RM** | MAHOGANY **MAH** | MOAB **MOB** | PEARWOOD **PW** | WALNUT **WAL** | WINDSOR CHERRY **WC** | CLASSIC CHERRY **CCY** | ESPRESSO **ESP** |

SIN 711-18 **CONTEMPO ARMLESS**

GUEST

**9430 Puzzle Back Chair**

20" W X 22" D X 34" H

St. Yardage: 1



FREIGHT CLASS: 250  
CUBIC FT: 15  
SHIP WEIGHT: 31

Grade	1	2	3	4	5	6	7	8	9	10	L	LL
<b>Zone 1</b>	737	772	803	822	849	860	881	903	931	965	1029	1162
<b>Zone 2</b>	748	784	815	834	862	873	894	917	945	979	1044	1179
<b>Zone 3</b>	759	795	827	847	874	886	907	930	959	994	1060	1197

- Solid hardwood frame
- Puzzle wood back
- Cross rails for added leg support
- Seat: 18.75"W x 18.75"D x 19"H

OPTION	PRICE	CODE
Casters for Guest Chairs	50.00	C

**QS**

**9500 Upholstered Back Chair**

20" W X 22" D X 34" H

St. Yardage: 1.5



FREIGHT CLASS: 250  
CUBIC FT: 15  
SHIP WEIGHT: 31

Grade	1	2	3	4	5	6	7	8	9	10	L	LL
<b>Zone 1</b>	790	825	857	893	926	969	986	1056	1100	1154	1217	1407
<b>Zone 2</b>	802	837	870	906	940	984	1001	1072	1117	1171	1235	1428
<b>Zone 3</b>	814	850	883	920	954	998	1016	1088	1133	1189	1254	1449

- Solid hardwood frame
- Upholstered back
- Cross rails for added leg support
- Seat: 18.75"W x 18.75"D x 19"H

OPTION	PRICE	CODE
Casters for Guest Chairs	50.00	C

**QS**

**9510 Partial Upholstered Back Chair**

20" W X 22" D X 34" H

St. Yardage: 1.5

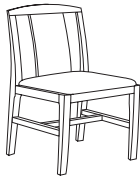

FREIGHT CLASS: 250  
CUBIC FT: 15  
SHIP WEIGHT: 33

Grade	1	2	3	4	5	6	7	8	9	10	L	LL
<b>Zone 1</b>	790	825	857	893	926	969	986	1056	1100	1154	1217	1407
<b>Zone 2</b>	802	837	870	906	940	984	1001	1072	1117	1171	1235	1428
<b>Zone 3</b>	814	850	883	920	954	998	1016	1088	1133	1189	1254	1449

- Solid hardwood frame
- Partially upholstered back
- Cross rails for added leg support
- Seat: 18.75"W x 18.75"D x 19"H

OPTION	PRICE	CODE
Casters for Guest Chairs	50.00	C

**QS**

**94CTC Ganging Kit**

- Chair-to-chair ganging
- Black powder coated 16 gauge steel
- One kit needed for each connection

10" W X 3.5" D X .125" H

Cubic Ft: 0.2

Ship Weight: 0.5

Zone Pricing	1	2	3
--------------	---	---	---

**28      28      29**

**QS**

FREIGHT CLASS: 70

ALL FOAM & FABRICS USED ARE CAL 117 APPROVED

**QS** indicates a Quickship item if ordered in Quickship upholstery. Quick Ship is not available on any item ordered with options.

# CONTEMPO ARM CHAIRS

SIN 711-18

## FINISH SELECTION

ASPEN **AP** | BLACK **BLK** | NATURAL **FM** | HONEY CHERRY **HCY** | ROUGE  
 MAHOGANY **RM** | MAHOGANY **MAH** | MOAB **MOB** | PEARWOOD **PW** | WALNUT  
 WAL | WINDSOR CHERRY **WC** | CLASSIC CHERRY **CCY** | ESPRESSO **ESP** |

GUEST

### Design Flexibility

**Contempo** presents elegant wood guest seating with extensive design flexibility. Solid hardwood frames offer the unique characteristics of wood. Choose from three arm styles. Select from four precision cut, multiple-layer hardwood plywood back designs known as Hourglass, Fan, Ladder and Puzzle.

### Contempo Features

- 3 arm designs: *curvilinear, sloped, and scalloped*
- 6 back designs: *hourglass, fan, ladder, puzzle, upholstered and partial upholstered backs*
- *Suspended, improved-cushioning seats*
- *Multiple-density foam*

Curvilinear Arm



Scalloped Arm



Sloped Arm



9433 Puzzle Back with Curvilinear Arms

## CONTEMPO ARM CHAIRS Hourglass Back

### 9403 Curvilinear Arms

22" W X 22.5" D X 34" H

St. Yardage: 1



FREIGHT CLASS: 250  
 CUBIC FT: 15  
 SHIP WEIGHT: 32

Grade	1	2	3	4	5	6	7	8	9	10	L	LL
Zone 1	790	825	857	893	926	969	986	1056	1100	1154	1217	1407
Zone 2	802	837	870	906	940	984	1001	1072	1117	1171	1235	1428
Zone 3	814	850	883	920	954	998	1016	1088	1133	1189	1254	1449

- Solid hardwood frame with reinforcing stretchers
- Flexible seat suspension

- Generous seat foam
- Seat: 18.75"W x 18.75"D x 19"H

OPTION	PRICE	CODE
Casters for Guest Chairs	50.00	C

QS

### 9404 Sloped Arms

22" W X 22.5" D X 34" H

St. Yardage: 1



FREIGHT CLASS: 250  
 CUBIC FT: 15  
 SHIP WEIGHT: 32

Grade	1	2	3	4	5	6	7	8	9	10	L	LL
Zone 1	790	825	857	893	926	969	986	1056	1100	1154	1217	1407
Zone 2	802	837	870	906	940	984	1001	1072	1117	1171	1235	1428
Zone 3	814	850	883	920	954	998	1016	1088	1133	1189	1254	1449

- Solid hardwood frame with reinforcing stretchers
- Flexible seat suspension

- Generous seat foam
- Seat: 18.75"W x 18.75"D x 19"H

OPTION	PRICE	CODE
Casters for Guest Chairs	50.00	C

QS

### 9405 Scalloped Arms

22" W X 22.5" D X 34" H

St. Yardage: 1

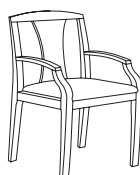

FREIGHT CLASS: 250  
 CUBIC FT: 15  
 SHIP WEIGHT: 32

Grade	1	2	3	4	5	6	7	8	9	10	L	LL
Zone 1	790	825	857	893	926	969	986	1056	1100	1154	1217	1407
Zone 2	802	837	870	906	940	984	1001	1072	1117	1171	1235	1428
Zone 3	814	850	883	920	954	998	1016	1088	1133	1189	1254	1449

- Solid hardwood frame with reinforcing stretchers
- Flexible seat suspension

- Generous seat foam
- Seat: 18.75"W x 18.75"D x 19"H

OPTION	PRICE	CODE
Casters for Guest Chairs	50.00	C

QS



FINISH SELECTION

ASPEN AP | BLACK BLK | NATURAL FM | HONEY CHERRY HCY | ROUGE MAHOGANY RM | MAHOGANY MAH | MOAB MOB | PEARWOOD PW | WALNUT WAL | WINDSOR CHERRY WC | CLASSIC CHERRY CCY | ESPRESSO ESP |

SIN 711-18

# CONTEMPO ARM CHAIRS

GUEST

## CONTEMPO ARM CHAIRS Fan Back

### 9413 Curvilinear Arms

22" W X 22.5" D X 34" H

St. Yardage: 1



FREIGHT CLASS: 250  
CUBIC FT: 15  
SHIP WEIGHT: 32

Grade	1	2	3	4	5	6	7	8	9	10	L	LL
Zone 1	790	825	857	893	926	969	986	1056	1100	1154	1217	1407
Zone 2	802	837	870	906	940	984	1001	1072	1117	1171	1235	1428
Zone 3	814	850	883	920	954	998	1016	1088	1133	1189	1254	1449

	OPTION	PRICE	CODE
• Solid hardwood frame with reinforcing stretchers	• Generous seat foam		
• Flexible seat suspension	• Seat: 18.75"W x 18.75"D x 19"H		
	Casters for Guest Chairs	50.00	C

QS

### 9414 Sloped Arms

22" W X 22.5" D X 34" H

St. Yardage: 1



FREIGHT CLASS: 250  
CUBIC FT: 15  
SHIP WEIGHT: 32

Grade	1	2	3	4	5	6	7	8	9	10	L	LL
Zone 1	790	825	857	893	926	969	986	1056	1100	1154	1217	1407
Zone 2	802	837	870	906	940	984	1001	1072	1117	1171	1235	1428
Zone 3	814	850	883	920	954	998	1016	1088	1133	1189	1254	1449

	OPTION	PRICE	CODE
• Solid hardwood frame with reinforcing stretchers	• Generous seat foam		
• Flexible seat suspension	• Seat: 18.75"W x 18.75"D x 19"H		
	Casters for Guest Chairs	50.00	C

QS

### 9415 Scalloped Arms

22" W X 22.5" D X 34" H

St. Yardage: 1



FREIGHT CLASS: 250  
CUBIC FT: 15  
SHIP WEIGHT: 32

Grade	1	2	3	4	5	6	7	8	9	10	L	LL
Zone 1	790	825	857	893	926	969	986	1056	1100	1154	1217	1407
Zone 2	802	837	870	906	940	984	1001	1072	1117	1171	1235	1428
Zone 3	814	850	883	920	954	998	1016	1088	1133	1189	1254	1449

	OPTION	PRICE	CODE
• Solid hardwood frame with reinforcing stretchers	• Generous seat foam		
• Flexible seat suspension	• Seat: 18.75"W x 18.75"D x 19"H		
	Casters for Guest Chairs	50.00	C

QS

## CONTEMPO ARM CHAIRS Ladder Back

### 9423 Curvilinear Arms

22" W X 22.5" D X 34" H

St. Yardage: 1



FREIGHT CLASS: 250  
CUBIC FT: 15  
SHIP WEIGHT: 32

Grade	1	2	3	4	5	6	7	8	9	10	L	LL
Zone 1	790	825	857	893	926	969	986	1056	1100	1154	1217	1407
Zone 2	802	837	870	906	940	984	1001	1072	1117	1171	1235	1428
Zone 3	814	850	883	920	954	998	1016	1088	1133	1189	1254	1449

	OPTION	PRICE	CODE
• Solid hardwood frame with reinforcing stretchers	• Generous seat foam		
• Flexible seat suspension	• Seat: 18.75"W x 18.75"D x 19"H		
	Casters for Guest Chairs	50.00	C

QS

### 9424 Sloped Arms

22" W X 22.5" D X 34" H

St. Yardage: 1



FREIGHT CLASS: 250  
CUBIC FT: 15  
SHIP WEIGHT: 32

Grade	1	2	3	4	5	6	7	8	9	10	L	LL
Zone 1	790	825	857	893	926	969	986	1056	1100	1154	1217	1407
Zone 2	802	837	870	906	940	984	1001	1072	1117	1171	1235	1428
Zone 3	814	850	883	920	954	998	1016	1088	1133	1189	1254	1449

	OPTION	PRICE	CODE
• Solid hardwood frame with reinforcing stretchers	• Generous seat foam		
• Flexible seat suspension	• Seat: 18.75"W x 18.75"D x 19"H		
	Casters for Guest Chairs	50.00	C

QS

### 9425 Scalloped Arms

22" W X 22.5" D X 34" H

St. Yardage: 1



FREIGHT CLASS: 250  
CUBIC FT: 15  
SHIP WEIGHT: 32

Grade	1	2	3	4	5	6	7	8	9	10	L	LL
Zone 1	790	825	857	893	926	969	986	1056	1100	1154	1217	1407
Zone 2	802	837	870	906	940	984	1001	1072	1117	1171	1235	1428
Zone 3	814	850	883	920	954	998	1016	1088	1133	1189	1254	1449

	OPTION	PRICE	CODE
• Solid hardwood frame with reinforcing stretchers	• Generous seat foam		
• Flexible seat suspension	• Seat: 18.75"W x 18.75"D x 19"H		
	Casters for Guest Chairs	50.00	C

QS

ALL FOAM & FABRICS USED ARE CAL 117 APPROVED

QS indicates a Quickship item if ordered in Quickship upholstery. Quick Ship is not available on any item ordered with options.

# CONTEMPO ARM CHAIRS

SIN 711-18

## FINISH SELECTION

ASPEN **AP** | BLACK **BLK** | NATURAL **FM** | HONEY CHERRY **HCY** | ROUGE MAHOGANY **RM** | MAHOGANY **MAH** | MOAB **MOB** | PEARWOOD **PW** | WALNUT **WAL** | WINDSOR CHERRY **WC** | CLASSIC CHERRY **CCY** | ESPRESSO **ESP** |

GUEST

## CONTEMPO ARM CHAIRS Puzzle Back

### 9433 Curvilinear Arms

22" W X 22.5" D X 34" H

St. Yardage: 1

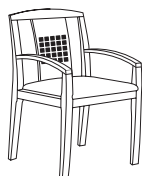

FREIGHT CLASS: 250  
CUBIC FT: 15  
SHIP WEIGHT: 32

Grade	1	2	3	4	5	6	7	8	9	10	L	LL
Zone 1	790	825	857	893	926	969	986	1056	1100	1154	1217	1407
Zone 2	802	837	870	906	940	984	1001	1072	1117	1171	1235	1428
Zone 3	814	850	883	920	954	998	1016	1088	1133	1189	1254	1449

	OPTION	PRICE	CODE
• Solid hardwood frame with reinforcing stretchers	• Generous seat foam		
• Flexible seat suspension	• Seat: 18.75"W x 18.75"D x 19"H		
	Casters for Guest Chairs	50.00	C

QS

### 9434 Sloped Arms

22" W X 22.5" D X 34" H

St. Yardage: 1



FREIGHT CLASS: 250  
CUBIC FT: 15  
SHIP WEIGHT: 32

Grade	1	2	3	4	5	6	7	8	9	10	L	LL
Zone 1	790	825	857	893	926	969	986	1056	1100	1154	1217	1407
Zone 2	802	837	870	906	940	984	1001	1072	1117	1171	1235	1428
Zone 3	814	850	883	920	954	998	1016	1088	1133	1189	1254	1449

	OPTION	PRICE	CODE
• Solid hardwood frame with reinforcing stretchers	• Generous seat foam		
• Flexible seat suspension	• Seat: 18.75"W x 18.75"D x 19"H		
	Casters for Guest Chairs	50.00	C

QS

### 9435 Scalloped Arms

22" W X 22.5" D X 34" H

St. Yardage: 1

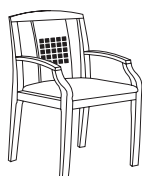

FREIGHT CLASS: 250  
CUBIC FT: 15  
SHIP WEIGHT: 32

Grade	1	2	3	4	5	6	7	8	9	10	L	LL
Zone 1	790	825	857	893	926	969	986	1056	1100	1154	1217	1407
Zone 2	802	837	870	906	940	984	1001	1072	1117	1171	1235	1428
Zone 3	814	850	883	920	954	998	1016	1088	1133	1189	1254	1449

	OPTION	PRICE	CODE
• Solid hardwood frame with reinforcing stretchers	• Generous seat foam		
• Flexible seat suspension	• Seat: 18.75"W x 18.75"D x 19"H		
	Casters for Guest Chairs	50.00	C

QS

## CONTEMPO ARM CHAIRS Fully Upholstered Back

### 9503 Curvilinear Arms

22" W X 22.5" D X 34" H

St. Yardage: 1.5



FREIGHT CLASS: 250  
CUBIC FT: 15  
SHIP WEIGHT: 37

Grade	1	2	3	4	5	6	7	8	9	10	L	LL
Zone 1	857	914	964	993	1036	1053	1088	1123	1167	1221	1324	1538
Zone 2	870	928	978	1008	1052	1069	1104	1140	1185	1239	1344	1561
Zone 3	883	941	993	1023	1067	1085	1121	1157	1202	1258	1364	1584

	OPTION	PRICE	CODE
• Solid hardwood frame with reinforcing stretchers	• Generous seat foam		
• Flexible seat suspension	• Seat: 18.75"W x 18.75"D x 19"H		
	Casters for Guest Chairs	50.00	C

QS

### 9504 Sloped Arms

22" W X 22.5" D X 34" H

St. Yardage: 1.5



FREIGHT CLASS: 250  
CUBIC FT: 15  
SHIP WEIGHT: 32

Grade	1	2	3	4	5	6	7	8	9	10	L	LL
Zone 1	857	914	964	993	1036	1053	1088	1123	1167	1221	1324	1538
Zone 2	870	928	978	1008	1052	1069	1104	1140	1185	1239	1344	1561
Zone 3	883	941	993	1023	1067	1085	1121	1157	1202	1258	1364	1584

	OPTION	PRICE	CODE
• Solid hardwood frame with reinforcing stretchers	• Generous seat foam		
• Flexible seat suspension	• Seat: 18.75"W x 18.75"D x 19"H		
	Casters for Guest Chairs	50.00	C

QS

### 9505 Scalloped Arms

22" W X 22.5" D X 34" H

St. Yardage: 1.5

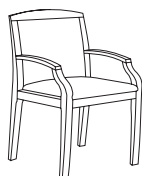

FREIGHT CLASS: 250  
CUBIC FT: 15  
SHIP WEIGHT: 32

Grade	1	2	3	4	5	6	7	8	9	10	L	LL
Zone 1	857	914	964	993	1036	1053	1088	1123	1167	1221	1324	1538
Zone 2	870	928	978	1008	1052	1069	1104	1140	1185	1239	1344	1561
Zone 3	883	941	993	1023	1067	1085	1121	1157	1202	1258	1364	1584

	OPTION	PRICE	CODE
• Solid hardwood frame with reinforcing stretchers	• Generous seat foam		
• Flexible seat suspension	• Seat: 18.75"W x 18.75"D x 19"H		
	Casters for Guest Chairs	50.00	C

QS

FINISH SELECTION

ASPEN **AP** | BLACK **BLK** | NATURAL **FM** | HONEY CHERRY **HCY** | ROUGE MAHOGANY **RM** | MAHOGANY **MAH** | MOAB **MOB** | PEARWOOD **PW** | WALNUT **WAL** | WINDSOR CHERRY **WC** | CLASSIC CHERRY **CCY** | ESPRESSO **ESP** |

SIN 711-18

# CONTEMPO ARM CHAIRS

GUEST

## CONTEMPO ARM CHAIRS Partial Upholstered Back

### 9513 Curvilinear Arms

22" W X 22.5" D X 34" H

St. Yardage: 1.5



FREIGHT CLASS: 250  
CUBIC FT: 15  
SHIP WEIGHT: 37

Grade	1	2	3	4	5	6	7	8	9	10	L	LL
<b>Zone 1</b>	857	914	964	993	1036	1053	1088	1123	1167	1221	1324	1538
<b>Zone 2</b>	870	928	978	1008	1052	1069	1104	1140	1185	1239	1344	1561
<b>Zone 3</b>	883	941	993	1023	1067	1085	1121	1157	1202	1258	1364	1584

- Solid hardwood frame with reinforcing stretchers
- Flexible seat suspension

- Generous seat foam
- Seat: 18.75"W x 18.75"D x 19"H

OPTION	PRICE	CODE
Casters for Guest Chairs	50.00	C

**QS**

### 9514 Sloped Arms

22" W X 22.5" D X 34" H

St. Yardage: 1.5



FREIGHT CLASS: 250  
CUBIC FT: 15  
SHIP WEIGHT: 32

Grade	1	2	3	4	5	6	7	8	9	10	L	LL
<b>Zone 1</b>	857	914	964	993	1036	1053	1088	1123	1167	1221	1324	1538
<b>Zone 2</b>	870	928	978	1008	1052	1069	1104	1140	1185	1239	1344	1561
<b>Zone 3</b>	883	941	993	1023	1067	1085	1121	1157	1202	1258	1364	1584

- Solid hardwood frame with reinforcing stretchers
- Flexible seat suspension

- Generous seat foam
- Seat: 18.75"W x 18.75"D x 19"H

OPTION	PRICE	CODE
Casters for Guest Chairs	50.00	C

**QS**

### 9515 Scalloped Arms

22" W X 22.5" D X 34" H

St. Yardage: 1.5

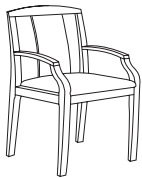

FREIGHT CLASS: 250  
CUBIC FT: 15  
SHIP WEIGHT: 32

Grade	1	2	3	4	5	6	7	8	9	10	L	LL
<b>Zone 1</b>	857	914	964	993	1036	1053	1088	1123	1167	1221	1324	1538
<b>Zone 2</b>	870	928	978	1008	1052	1069	1104	1140	1185	1239	1344	1561
<b>Zone 3</b>	883	941	993	1023	1067	1085	1121	1157	1202	1258	1364	1584

- Solid hardwood frame with reinforcing stretchers
- Flexible seat suspension

- Generous seat foam
- Seat: 18.75"W x 18.75"D x 19"H

OPTION	PRICE	CODE
Casters for Guest Chairs	50.00	C

**QS**

### 94CTC Ganging Kit

- Chair-to-chair ganging
- Black powder coated 16 gauge steel
- One kit needed for each connection

10" W X 3.5" D X .125" H

Cubic Ft: 0.2

Ship Weight: 0.5

Zone Pricing	1	2	3
	28	28	29

FREIGHT CLASS: 70

ALL FOAM & FABRICS USED ARE CAL 117 APPROVED

**QS** indicates a Quickship item if ordered in Quickship upholstery. Quick Ship is not available on any item ordered with options.

GUEST

### Affordable Elegance

Great design translates into all languages, and the **Accent** designs speak volumes. Graceful lines and contours are exercised in extra-thick solid wood frames with multistep finishes. Triple-groove construction of seat frame rails and corner blocks increases rigidity and long-term durability.

### Accent Features

- Four beautiful back designs
- Executive style and scale
- Triple-groove construction
- 3" thick seat cushion

### Accent Back Design Details

- Lattice wood back, available with or without back upholstery
- Open back, available with or without upholstered chair rail
- Half wood back with upholstered inset and clean-out feature
- Full wood back with upholstered inset



683 Accent



693 Accent



694 Accent

## Accent

### 683 Open Back Guest Chair

23.5" W X 23" D X 31" H

St. Yardage: 1

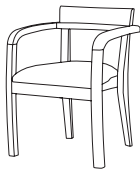

FREIGHT CLASS: 250  
CUBIC FT: 24  
SHIP WEIGHT: 40

Grade	1	2	3	4	5	6	7	8	9	10	L	LL
Zone 1	542	558	577	594	610	632	640	675	697	724	776	898
Zone 2	550	566	586	603	619	641	650	685	707	735	788	911
Zone 3	558	575	594	612	628	651	659	695	718	746	799	925

- Open back
- Solid wood frame
- Triple-step corner block reinforcement
- Comfort-flex seat suspension
- 3" thick seat cushion
- Available in finishes listed above
- Seat: (19.5"F-12.5"B)W x 18.5"D x 18"H

QS

### 683U Open Back Guest Chair

23.5" W X 23" D X 31" H

St. Yardage: 1

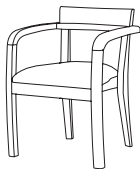

FREIGHT CLASS: 250  
CUBIC FT: 24  
SHIP WEIGHT: 40

Grade	1	2	3	4	5	6	7	8	9	10	L	LL
Zone 1	592	612	636	657	677	704	715	758	786	820	884	1037
Zone 2	601	621	646	667	687	715	726	769	798	832	897	1053
Zone 3	610	630	655	677	697	725	736	781	810	845	911	1068

- Open back with upholstered back rail
- Solid wood frame
- Triple-step corner block reinforcement
- Comfort-flex seat suspension
- 3" thick seat cushion
- Seat: (19.5"F-12.5"B)W x 18.5"D x 18"H

QS

### 693 Wood Back Guest Chair

25" W X 23" D X 35" H

St. Yardage: 1



FREIGHT CLASS: 250  
CUBIC FT: 24  
SHIP WEIGHT: 48

Grade	1	2	3	4	5	6	7	8	9	10	L	LL
Zone 1	645	661	680	697	713	735	743	778	800	827	879	1001
Zone 2	655	671	690	707	724	746	754	790	812	839	892	1016
Zone 3	664	681	700	718	734	757	765	801	824	852	905	1031

- Wood lattice back
- Solid wood frame
- Triple-step corner block reinforcement
- Comfort-flex seat suspension
- 3" thick seat cushion
- Seat: (19.5"F-12.5"B)W x 18.5"D x 18"H

QS

# FINISH SELECTION

ASPEN **AP** | BLACK **BLK** | NATURAL **FM** | HONEY CHERRY **HCY** | ROUGE MAHOGANY **RM** | MAHOGANY **MAH** | MOAB **MOB** | PEARWOOD **PW** | WALNUT **WAL** | WINDSOR CHERRY **WC** | CLASSIC CHERRY **CCY** | ESPRESSO **ESP** | NATURAL **FM** |

SIN 711-18 **ACCENT**

GUEST

## 693U Wood Back Guest Chair

25" W X 23" D X 35" H

St. Yardage: 1.25

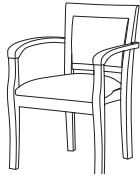

FREIGHT CLASS: 250  
CUBIC FT: 24  
SHIP WEIGHT: 48

Grade	1	2	3	4	5	6	7	8	9	10	L	LL
<b>Zone 1</b>	695	715	739	760	780	807	818	861	889	923	987	1140
<b>Zone 2</b>	705	726	750	771	792	819	830	874	902	937	1002	1157
<b>Zone 3</b>	716	736	761	783	803	831	843	887	916	951	1017	1174

- Wood lattice back with upholstered inner back
- Solid wood frame
- Triple-step corner block reinforcement
- Comfort-flex seat suspension
- 3" thick seat cushion
- Seat: (19.5"F-12.5"B)W x 18.5"D x 18"H

**QS**

## 694 Halfback Guest Chair

26" W X 23" D X 35" H

St. Yardage: 1.75

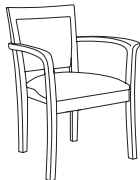

FREIGHT CLASS: 250  
CUBIC FT: 24  
SHIP WEIGHT: 49

Grade	1	2	3	4	5	6	7	8	9	10	L	LL
<b>Zone 1</b>	780	813	851	883	916	959	976	1046	1090	1144	1247	1492
<b>Zone 2</b>	792	825	864	896	930	973	991	1062	1106	1161	1266	1514
<b>Zone 3</b>	803	837	877	909	943	988	1005	1077	1123	1178	1284	1537

- Upholstered halfback for cleanout
- Solid wood frame
- Triple-step corner block reinforcement
- Comfort-flex seat suspension
- 3" thick seat cushion
- Seat: (19.5"F-12.5"B)W x 18.5"D x 18"H

**QS**

## 695 Fullback Guest Chair

26" W X 23" D X 35" H

St. Yardage: 1.75

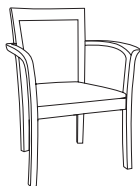

FREIGHT CLASS: 250  
CUBIC FT: 24  
SHIP WEIGHT: 48

Grade	1	2	3	4	5	6	7	8	9	10	L	LL
<b>Zone 1</b>	780	813	851	883	916	959	976	1046	1090	1144	1247	1492
<b>Zone 2</b>	792	825	864	896	930	973	991	1062	1106	1161	1266	1514
<b>Zone 3</b>	803	837	877	909	943	988	1005	1077	1123	1178	1284	1537

- Upholstered fullback
- Solid wood frame
- Triple-step corner block reinforcement
- Comfort-flex seat suspension
- 3" thick seat cushion
- Seat: (19.5"F-12.5"B)W x 18.5"D x 18"H

**QS**

## 683C Open Back Guest Chair, Casters

23.5" W X 23" D X 31" H

St. Yardage: 1

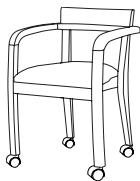

FREIGHT CLASS: 250  
CUBIC FT: 24  
SHIP WEIGHT: 40

Grade	1	2	3	4	5	6	7	8	9	10	L	LL
<b>Zone 1</b>	592	608	627	644	660	682	690	725	747	774	826	948
<b>Zone 2</b>	601	617	636	654	670	692	700	736	758	786	838	962
<b>Zone 3</b>	610	626	646	663	680	702	711	747	769	797	851	976

- Open back
- Solid wood frame
- Triple-step corner block reinforcement
- Casters for mobility
- Comfort-flex seat suspension
- 3" thick seat cushion
- Seat: (12.5"B-19.5"F)W x 18.5"D x 18"H

**QS**

## 683UC Open/Upholstered Back Chair, Casters

23.5" W X 23" D X 31" H

St. Yardage: 1

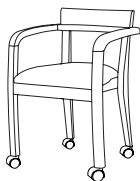

FREIGHT CLASS: 250  
CUBIC FT: 24  
SHIP WEIGHT: 40

Grade	1	2	3	4	5	6	7	8	9	10	L	LL
<b>Zone 1</b>	642	662	686	707	727	754	765	808	836	870	934	1087
<b>Zone 2</b>	652	672	696	718	738	765	776	820	849	883	948	1103
<b>Zone 3</b>	661	682	707	728	749	777	788	832	861	896	962	1120

- Open back with upholstered back rail
- Solid wood frame
- Triple-step corner block reinforcement
- Casters for mobility
- Comfort-flex seat suspension
- 3" thick seat cushion
- Seat: (12.5"B-19.5"F)W x 18.5"D x 18"H

**QS**

ALL FOAM & FABRICS USED ARE CAL 117 APPROVED

**QS** indicates a Quickship item if ordered in Quickship upholstery. Quick Ship is not available on any item ordered with options.

# ACCENT SIN 711-18

## FINISH SELECTION

ASPEN **AP** | BLACK **BLK** | NATURAL **FM** | HONEY CHERRY **HCY** | ROUGE MAHOGANY **RM** | MAHOGANY **MAH** | MOAB **MOB** | PEARWOOD **PW** | WALNUT **WAL** | WINDSOR CHERRY **WC** | CLASSIC CHERRY **CCY** | ESPRESSO **ESP** | NATURAL **FM** |

GUEST

### 693C Wood Back Guest Chair, Casters

25" W X 23" D X 35" H

St. Yardage: 1



FREIGHT CLASS: 250  
CUBIC FT: 24  
SHIP WEIGHT: 48

QS

Grade	1	2	3	4	5	6	7	8	9	10	L	LL
Zone 1	695	711	730	747	763	785	793	828	850	877	929	1051
Zone 2	705	722	741	758	774	797	805	840	863	890	943	1067
Zone 3	716	732	752	769	786	809	817	853	876	903	957	1083

- Wood lattice back
- Solid wood frame
- Triple-step corner block reinforcement
- Casters for mobility
- Comfort-flex seat suspension
- 3" thick seat cushion
- Seat: (12.5"B-19.5"F)W x 18.5"D x 18"H

### 693UC Upholstered Lattice Back Guest Chair, Casters

25" W X 23" D X 35" H

St. Yardage: 1.25

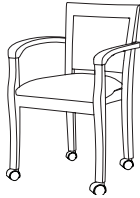

FREIGHT CLASS: 250  
CUBIC FT: 24  
SHIP WEIGHT: 48

QS

Grade	1	2	3	4	5	6	7	8	9	10	L	LL
Zone 1	755	765	789	810	830	857	868	911	939	973	1037	1190
Zone 2	766	776	801	822	842	870	881	925	953	988	1053	1208
Zone 3	778	788	813	834	855	883	894	938	967	1002	1068	1226

- Wood lattice back with upholstered inner back
- Solid wood frame
- Triple-step corner block reinforcement
- Casters for mobility
- Comfort-flex seat suspension
- 3" thick seat cushion
- Seat: (12.5"B-19.5"F)W x 18.5"D x 18"H

### 694C Halfback Guest Chair, Casters

26" W X 23" D X 35" H

St. Yardage: 1.5

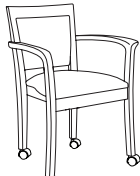

FREIGHT CLASS: 250  
CUBIC FT: 24  
SHIP WEIGHT: 49

QS

Grade	1	2	3	4	5	6	7	8	9	10	L	LL
Zone 1	830	863	901	933	966	1009	1026	1096	1140	1194	1297	1542
Zone 2	842	876	915	947	980	1024	1041	1112	1157	1212	1316	1565
Zone 3	855	889	928	961	995	1039	1057	1129	1174	1230	1336	1588

- Upholstered halfback for cleanout
- Solid wood frame
- Triple-step corner block reinforcement
- Casters for mobility
- Comfort-flex seat suspension
- 3" thick seat cushion
- Seat: (12.5"B-19.5"F)W x 18.5"D x 18"H

### 695C Fullback Guest Chair, Casters

26" W X 23" D X 35" H

St. Yardage: 1.5

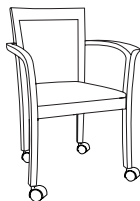

FREIGHT CLASS: 250  
CUBIC FT: 24  
SHIP WEIGHT: 49

QS

Grade	1	2	3	4	5	6	7	8	9	10	L	LL
Zone 1	830	863	901	933	966	1009	1026	1096	1140	1194	1297	1542
Zone 2	842	876	915	947	980	1024	1041	1112	1157	1212	1316	1565
Zone 3	855	889	928	961	995	1039	1057	1129	1174	1230	1336	1588

- Upholstered fullback
- Solid wood frame
- Triple-step corner block reinforcement
- Casters for mobility
- Comfort-flex seat suspension
- 3" thick seat cushion
- Seat: (12.5"B-19.5"F)W x 18.5"D x 18"H



**Guest Seating: A Soft Touch**

No one enjoys waiting, but **High Street** ganged lounge seating might make you look at your watch a little less often.

The fully upholstered design offers visitors a comfortably soft touch on every surface.



**850 Radius Back and Arms**

**High Street Features**

- Four unique arm and back profiles
- All styles available with high back
- Open air design facilitates easy cleaning
- Wall-saver profile to reduce wear and tear
- Bariatric seating available

**Options Available**

- Glider option may be added to any single or multi-seat unit with center legs
- Two color upholstery combinations available



**881 High back**

**PROFILE DETAIL**

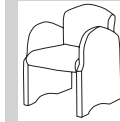

850 Radius Arm/Radius Back

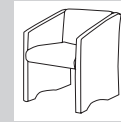

860 Slant Arm/Straight Back

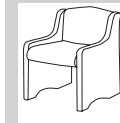

870 Low Arm/Camel Back

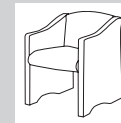

880 Slope Arm/Camel Back

**High Street**

**850 Arm Chair**

24.75" W X 27.5" D X 33.5" H St. Yardage: 5

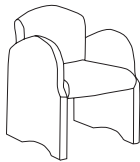

FREIGHT CLASS: 250  
CUBIC FT: 19  
SHIP WEIGHT: 67

**QS**

Grade	1	2	3	4	5	6	7	8	9	10	L	LL
<b>Zone 1</b>	938	1018	1099	1196	1278	1386	1428	1604	1712	1848	2031	2318
<b>Zone 2</b>	952	1033	1115	1214	1297	1407	1449	1628	1738	1876	2061	2353
<b>Zone 3</b>	966	1049	1132	1232	1316	1428	1471	1652	1763	1903	2092	2388

- Radius back/arms
- Fully upholstered
- Add a glider by choosing the motion option
- See ganging section for multi-seat configurations
- Seat: 20.25"W x 20"D x 20"H

OPTION	PRICE	CODE
Softer Seat Foam-Chair	16.00	SF
Motion Seat & Back	268.00	-60

**860 Arm Chair**

24.75" W X 27.5" D X 33.5" H St. Yardage: 5

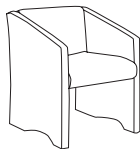

FREIGHT CLASS: 250  
CUBIC FT: 19  
SHIP WEIGHT: 67

**QS**

Grade	1	2	3	4	5	6	7	8	9	10	L	LL
<b>Zone 1</b>	938	1018	1099	1196	1278	1386	1428	1604	1712	1848	2031	2318
<b>Zone 2</b>	952	1033	1115	1214	1297	1407	1449	1628	1738	1876	2061	2353
<b>Zone 3</b>	966	1049	1132	1232	1316	1428	1471	1652	1763	1903	2092	2388

- Slant arms, straight back
- Fully upholstered
- Add a glider by choosing the motion option
- See ganging section for multi-seat configurations
- Seat: 20.25"W x 20"D x 20"H

OPTION	PRICE	CODE
Softer Seat Foam-Chair	16.00	SF
Motion Seat & Back	268.00	-60

**870 Arm Chair**

24.75" W X 27.5" D X 33.5" H St. Yardage: 5

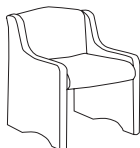

FREIGHT CLASS: 250  
CUBIC FT: 15  
SHIP WEIGHT: 32

**QS**

Grade	1	2	3	4	5	6	7	8	9	10	L	LL
<b>Zone 1</b>	938	1018	1099	1196	1278	1386	1428	1604	1712	1848	2031	2318
<b>Zone 2</b>	952	1033	1115	1214	1297	1407	1449	1628	1738	1876	2061	2353
<b>Zone 3</b>	966	1049	1132	1232	1316	1428	1471	1652	1763	1903	2092	2388

- Low arms, camelback
- Fully upholstered
- Add a glider by choosing the motion option
- See ganging section for multi-seat configurations
- Seat: 20.25"W x 20"D x 20"H

OPTION	PRICE	CODE
Softer Seat Foam-Chair	16.00	SF
Motion Seat & Back	268.00	-60

ALL FOAM & FABRICS USED ARE CAL 117 APPROVED

**QS** indicates a Quickship item if ordered in Quickship upholstery. Quick Ship is not available on any item ordered with options.

# HIGH STREET SIN 711-16

GUEST

## 880 Arm Chair

24.75" W X 27.5" D X 33.5" H St. Yardage: 5

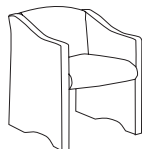

FREIGHT CLASS: 250  
CUBIC FT: 19  
SHIP WEIGHT: 67

Grade	1	2	3	4	5	6	7	8	9	10	L	LL
Zone 1	938	1018	1099	1196	1278	1386	1428	1604	1712	1848	2031	2318
Zone 2	952	1033	1115	1214	1297	1407	1449	1628	1738	1876	2061	2353
Zone 3	966	1049	1132	1232	1316	1428	1471	1652	1763	1903	2092	2388

- Slope arms, camelback
- Fully upholstered
- Add a glider by choosing the motion option
- See ganging section for multi-seat configurations
- Seat: 20.25"W x 20"D x 20"H

OPTION	PRICE	CODE
Softer Seat Foam-Chair	16.00	SF
Motion Seat & Back	268.00	-60

QS

## 8\_0-60 Motion Seat & Back Glider Option

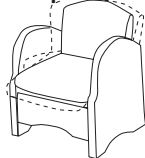

- Add glider motion to any High Street model
- Add -60 to end of model number and price of glider to chair price
- Not available on Bariatric Chair

FREIGHT CLASS: 250

		Zone Pricing		
		1	2	3
Cubic Ft:	Ship Weight: 6	268	268	268

## 8\_0-30 Bariatric Chair Option

35" W X 27.5" D X 33.5" H St. Yardage: 6

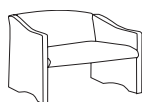

FREIGHT CLASS: 250  
CUBIC FT: 29  
SHIP WEIGHT: 91

Grade	1	2	3	4	5	6	7	8	9	10	L	LL
Zone 1	1313	1401	1488	1606	1699	1823	1946	2070	2193	2347	2509	2841
Zone 2	1333	1422	1510	1630	1724	1850	1975	2101	2226	2382	2547	2884
Zone 3	1352	1443	1533	1654	1750	1878	2004	2132	2259	2417	2584	2926

- Choose any back/arm style above (880-30 shown)
- 30" wide seat
- Reinforced seat frame
- Fully upholstered
- Rated to 500 lbs
- Seat: 30"W x 20"D x 20"H

OPTION	PRICE	CODE
Softer Seat Foam-Loveseat	32.00	SF

QS

## 851 High Back Arm Chair

25.75" W X 29" D X 39" H St. Yardage: 5.75

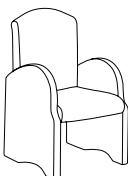

FREIGHT CLASS: 250  
CUBIC FT: 21  
SHIP WEIGHT: 69

Grade	1	2	3	4	5	6	7	8	9	10	L	LL
Zone 1	987	1066	1158	1245	1327	1435	1544	1653	1761	1897	2132	2467
Zone 2	1002	1082	1175	1264	1347	1457	1567	1678	1787	1925	2164	2504
Zone 3	1017	1098	1193	1282	1367	1478	1590	1703	1814	1954	2196	2541

- Extra high back
- Radius back/arms
- Fully upholstered
- Wall saver profile
- Add a glider by choosing the motion option
- See ganging section for multi-seat configurations
- Seat: 20.25"W x 20"D x 20"H

OPTION	PRICE	CODE
Softer Seat Foam-Chair	16.00	SF
Motion Seat & Back	268.00	-60

QS

## 861 High Back Arm Chair

25.75" W X 29" D X 39" H St. Yardage: 5.75

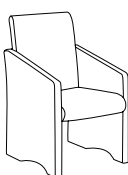

FREIGHT CLASS: 250  
CUBIC FT: 21  
SHIP WEIGHT: 69

Grade	1	2	3	4	5	6	7	8	9	10	L	LL
Zone 1	987	1066	1158	1245	1327	1435	1544	1653	1761	1897	2132	2467
Zone 2	1002	1082	1175	1264	1347	1457	1567	1678	1787	1925	2164	2504
Zone 3	1017	1098	1193	1282	1367	1478	1590	1703	1814	1954	2196	2541

- Extra high back
- Slant arms, straight back
- Fully upholstered
- Wall saver profile
- Add a glider by choosing the motion option
- See ganging section for multi-seat configurations
- Seat: 20.25"W x 20"D x 20"H

OPTION	PRICE	CODE
Softer Seat Foam-Chair	16.00	SF
Motion Seat & Back	268.00	-60

QS

**871 High Back Arm Chair**

25.75" W X 29" D X 39" H

St. Yardage: 5.75



FREIGHT CLASS: 250  
CUBIC FT: 21  
SHIP WEIGHT: 69

Grade	1	2	3	4	5	6	7	8	9	10	L	LL
<b>Zone 1</b>	<b>987</b>	<b>1066</b>	<b>1158</b>	<b>1245</b>	<b>1327</b>	<b>1435</b>	<b>1544</b>	<b>1653</b>	<b>1761</b>	<b>1897</b>	<b>2132</b>	<b>2467</b>
<b>Zone 2</b>	<b>1002</b>	<b>1082</b>	<b>1175</b>	<b>1264</b>	<b>1347</b>	<b>1457</b>	<b>1567</b>	<b>1678</b>	<b>1787</b>	<b>1925</b>	<b>2164</b>	<b>2504</b>
<b>Zone 3</b>	<b>1017</b>	<b>1098</b>	<b>1193</b>	<b>1282</b>	<b>1367</b>	<b>1478</b>	<b>1590</b>	<b>1703</b>	<b>1814</b>	<b>1954</b>	<b>2196</b>	<b>2541</b>

- Extra high back
- Low arms, camelback
- Fully upholstered
- Wall saver profile

- Add a glider by choosing the motion option
- See ganging section for multi-seat configurations
- Seat: 20.25"W x 20"D x 20"H

OPTION	PRICE	CODE
Softer Seat Foam-Chair	16.00	SF
Motion Seat & Back	268.00	-60

**QS**

**881 High Back Arm Chair**

25.75" W X 29" D X 39" H

St. Yardage: 5.75

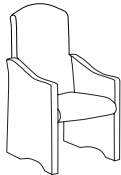

FREIGHT CLASS: 250  
CUBIC FT: 21  
SHIP WEIGHT: 69

Grade	1	2	3	4	5	6	7	8	9	10	L	LL
<b>Zone 1</b>	<b>987</b>	<b>1066</b>	<b>1158</b>	<b>1245</b>	<b>1327</b>	<b>1435</b>	<b>1544</b>	<b>1653</b>	<b>1761</b>	<b>1897</b>	<b>2132</b>	<b>2467</b>
<b>Zone 2</b>	<b>1002</b>	<b>1082</b>	<b>1175</b>	<b>1264</b>	<b>1347</b>	<b>1457</b>	<b>1567</b>	<b>1678</b>	<b>1787</b>	<b>1925</b>	<b>2164</b>	<b>2504</b>
<b>Zone 3</b>	<b>1017</b>	<b>1098</b>	<b>1193</b>	<b>1282</b>	<b>1367</b>	<b>1478</b>	<b>1590</b>	<b>1703</b>	<b>1814</b>	<b>1954</b>	<b>2196</b>	<b>2541</b>

- Extra high back
- Sloped arms, camelback
- Fully upholstered
- Wall saver profile

- Add a glider by choosing the motion option
- See ganging section for multi-seat configurations
- Seat: 20.25"W x 20"D x 20"H

OPTION	PRICE	CODE
Softer Seat Foam-Chair	16.00	SF
Motion Seat & Back	268.00	-60

**QS**

**Motions Seat & Back Glider High Back**

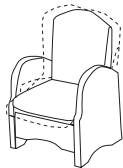

- Add glider motion to any High Street model
- Add -60 to end of model number and price of glider to chair price
- Not available on Bariatric Chair

FREIGHT CLASS: 250

		Zone Pricing		
		1	2	3
<b>8 1-60</b>	Cubic Ft: Ship Weight: 6	<b>268</b>	<b>268</b>	<b>268</b>

ALL FOAM & FABRICS USED ARE CAL 117 APPROVED

**QS** indicates a Quickship item if ordered in Quickship upholstery. Quick Ship is not available on any item ordered with options.

GUEST

### Synthesis of High Comfort + Elegant Design

**HiLeg** is the synthesis of high-comfort reception/lounge seating and wood-leg chair designs. Fully upholstered seats, backs and arms feature scale and materials for generous comfort. Choose from four distinct designs. All rest on a solid hardwood leg base available in any finish, standard or custom.

### HiLeg Conference Details

- Executive lounge
- 4 distinct choices of back and arm profiles
- Solid hardwood base and legs
- Fully upholstered seat and back

### Lounge Options

- All styles available in two-seat settee or three-seat sofa



8501 Radius Arm/Back



8601 Slant Arm Straight Back



8701 Low Arm Camel Back



8801 Sloped Arms Camel Back

## HiLeg

### 8501 Chair

25" W X 25" D X 31.5" H

St. Yardage: 4.25

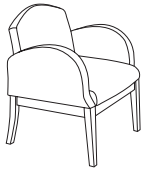

FREIGHT CLASS: 250  
 CUBIC FT: 19  
 SHIP WEIGHT: 47

Grade	1	2	3	4	5	6	7	8	9	10	L	LL
Zone 1	1205	1269	1333	1399	1460	1541	1573	1704	1786	1888	2064	2450
Zone 2	1223	1288	1353	1420	1482	1564	1597	1730	1813	1916	2095	2487
Zone 3	1241	1307	1373	1441	1504	1587	1620	1755	1840	1945	2126	2524

- Radius back/arms
- See features in series overview
- Seat: 20.25"W x 20"D x 20"H

OPTION	PRICE	CODE
Softer Seat Foam-Chair	16.00	SF

### QS

### 8502 Two-Seat Settee

44" W X 25" D X 31.5" H

St. Yardage: 6



FREIGHT CLASS: 250  
 CUBIC FT: 37  
 SHIP WEIGHT: 59

Grade	1	2	3	4	5	6	7	8	9	10	L	LL
Zone 1	1515	1641	1767	1902	2025	2188	2251	2514	2677	2880	3232	3985
Zone 2	1538	1666	1794	1931	2055	2221	2285	2552	2717	2923	3280	4045
Zone 3	1560	1690	1820	1959	2086	2254	2319	2589	2757	2966	3329	4105

- Radius back/arms
- See features in series overview above
- Seat: 40"W x 20"D x 20"H

OPTION	PRICE	CODE
Softer Seat Foam-Loveseat	32.00	SF

### QS

# FINISH SELECTION

ASPEN **AP** | BLACK **BLK** | NATURAL **FM** | HONEY CHERRY **HCY** | ROUGE MAHOGANY **RM** | MAHOGANY **MAH** | MOAB **MOB** | PEARWOOD **PW** | WALNUT **WAL** | WINDSOR CHERRY **WC** | CLASSIC CHERRY **CCY** | ESPRESSO **ESP** |

SIN 711-16 **HILEG**

GUEST

## 8503 Three-Seat Sofa

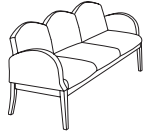

FREIGHT CLASS: 250  
CUBIC FT: 55  
SHIP WEIGHT: 82

63" W X 25" D X 31.5" H

St. Yardage: 7.5

Grade	1	2	3	4	5	6	7	8	9	10	L	LL
Zone 1	1916	2104	2294	2497	2680	2925	3019	3414	3659	3964	4492	5421
Zone 2	1945	2136	2328	2534	2720	2969	3064	3465	3714	4023	4559	5502
Zone 3	1973	2167	2363	2572	2760	3013	3110	3516	3769	4083	4627	5584

- Radius back/arms
- See features in series overview above
- Seat: 60"W x 20"D x 20"H

OPTION	PRICE	CODE
Softer Seat Foam-Sofa	48.00	SF

**QS**

## 8601 Chair

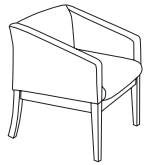

FREIGHT CLASS: 250  
CUBIC FT: 19  
SHIP WEIGHT: 48

25" W X 25" D X 31" H

St. Yardage: 4.25

Grade	1	2	3	4	5	6	7	8	9	10	L	LL
Zone 1	1082	1145	1207	1276	1337	1418	1450	1581	1663	1765	1940	2417
Zone 2	1098	1162	1225	1295	1357	1439	1472	1605	1688	1791	1969	2453
Zone 3	1114	1179	1243	1314	1377	1461	1494	1628	1713	1818	1998	2490

- Slant arm design with straight back
- See features in series overview above
- Seat: 20.25"W x 20"D x 20"H

OPTION	PRICE	CODE
Softer Seat Foam-Chair	16.00	SF

**QS**

## 8602 Two-Seat Settee

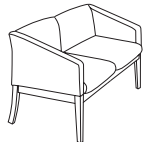

FREIGHT CLASS: 250  
CUBIC FT: 37  
SHIP WEIGHT: 60

44" W X 25" D X 31" H

St. Yardage: 6

Grade	1	2	3	4	5	6	7	8	9	10	L	LL
Zone 1	1353	1480	1606	1740	1863	2026	2089	2352	2515	2718	3070	3923
Zone 2	1373	1502	1630	1766	1891	2056	2120	2387	2553	2759	3116	3982
Zone 3	1394	1524	1654	1792	1919	2087	2152	2423	2590	2800	3162	4041

- Slant arm design with straight back
- See features in series overview above
- Seat: 40"W x 20"D x 20"H

OPTION	PRICE	CODE
Softer Seat Foam-Loveseat	32.00	SF

**QS**

## 8603 Three-Seat Sofa

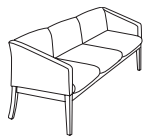

FREIGHT CLASS: 250  
CUBIC FT: 55  
SHIP WEIGHT: 84

63" W X 25" D X 31" H

St. Yardage: 7.5

Grade	1	2	3	4	5	6	7	8	9	10	L	LL
Zone 1	1699	1889	2078	2280	2463	2708	2802	3197	3442	3747	4276	5504
Zone 2	1724	1917	2109	2314	2500	2749	2844	3245	3494	3803	4340	5587
Zone 3	1750	1946	2140	2348	2537	2789	2886	3293	3545	3859	4404	5669

- Slant arm design with straight back
- See features in series overview above
- Seat: 60"W x 20"D x 20"H

OPTION	PRICE	CODE
Softer Seat Foam-Sofa	48.00	SF

**QS**

## 8701 Chair



FREIGHT CLASS: 250  
CUBIC FT: 19  
SHIP WEIGHT: 44

25" W X 25" D X 31.5" H

St. Yardage: 4.25

Grade	1	2	3	4	5	6	7	8	9	10	L	LL
Zone 1	1082	1145	1207	1276	1337	1418	1450	1581	1663	1765	1940	2417
Zone 2	1098	1162	1225	1295	1357	1439	1472	1605	1688	1791	1969	2453
Zone 3	1114	1179	1243	1314	1377	1461	1494	1628	1713	1818	1998	2490

- Low arm design with camel back
- See features in series overview above
- Seat: 20.25"W x 20"D x 20"H

OPTION	PRICE	CODE
Softer Seat Foam-Chair	16.00	SF

**QS**

ALL FOAM & FABRICS USED ARE CAL 117 APPROVED

**QS** indicates a Quickship item if ordered in Quickship upholstery. Quick Ship is not available on any item ordered with options.

## FINISH SELECTION

ASPEN **AP** | BLACK **BLK** | NATURAL **FM** | HONEY CHERRY **HCY** | ROUGE MAHOGANY **RM** | MAHOGANY **MAH** | MOAB **MOB** | PEARWOOD **PW** | WALNUT **WAL** | WINDSOR CHERRY **WC** | CLASSIC CHERRY **CCY** | ESPRESSO **ESP** |

GUEST

### 8702 Two-Seat Settee

44" W X 25" D X 31.5" H

St. Yardage: 6

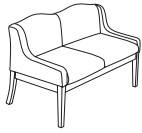

FREIGHT CLASS: 250  
CUBIC FT: 50  
SHIP WEIGHT: 50

**QS**

Grade	1	2	3	4	5	6	7	8	9	10	L	LL
Zone 1	1353	1480	1606	1740	1863	2026	2089	2352	2515	2718	3070	3923
Zone 2	1373	1502	1630	1766	1891	2056	2120	2387	2553	2759	3116	3982
Zone 3	1394	1524	1654	1792	1919	2087	2152	2423	2590	2800	3162	4041

- Low arm design with camel backs
- See features in series overview above
- Seat: 40"W x 20"D x 20"H

OPTION	PRICE	CODE
Softer Seat Foam-Loveseat	32.00	SF

### 8703 Three-Seat Sofa

63" W X 25" D X 31.5" H

St. Yardage: 7.5

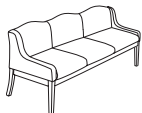

FREIGHT CLASS: 250  
CUBIC FT: 54  
SHIP WEIGHT: 84

**QS**

Grade	1	2	3	4	5	6	7	8	9	10	L	LL
Zone 1	1699	1889	2078	2280	2463	2708	2802	3197	3442	3747	4276	5504
Zone 2	1724	1917	2109	2314	2500	2749	2844	3245	3494	3803	4340	5587
Zone 3	1750	1946	2140	2348	2537	2789	2886	3293	3545	3859	4404	5669

- Low arm design with camel backs
- See features in series overview above
- Seat: 60"W x 20"D x 20"H

OPTION	PRICE	CODE
Softer Seat Foam-Sofa	48.00	SF

### 8801 Chair

25" W X 25" D X 31.5" H

St. Yardage: 4.25

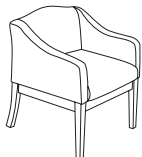

FREIGHT CLASS: 250  
CUBIC FT: 19  
SHIP WEIGHT: 49

**QS**

Grade	1	2	3	4	5	6	7	8	9	10	L	LL
Zone 1	1205	1269	1333	1399	1460	1541	1573	1704	1786	1888	2064	2450
Zone 2	1223	1288	1353	1420	1482	1564	1597	1730	1813	1916	2095	2487
Zone 3	1241	1307	1373	1441	1504	1587	1620	1755	1840	1945	2126	2524

- Sloped arm design with camel back
- See features in series overview above
- Seat: 20.25"W x 20"D x 20"H

OPTION	PRICE	CODE
Softer Seat Foam-Chair	16.00	SF

### 8802 Two-Seat Settee

44" W X 25" D X 31.5" H

St. Yardage: 6

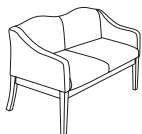

FREIGHT CLASS: 250  
CUBIC FT: 37  
SHIP WEIGHT: 59

**QS**

Grade	1	2	3	4	5	6	7	8	9	10	L	LL
Zone 1	1515	1641	1767	1902	2025	2188	2251	2514	2677	2880	3232	3985
Zone 2	1538	1666	1794	1931	2055	2221	2285	2552	2717	2923	3280	4045
Zone 3	1560	1690	1820	1959	2086	2254	2319	2589	2757	2966	3329	4105

- Sloped arm design with camel backs
- See features in series overview above
- Seat: 40"W x 20"D x 20"H

OPTION	PRICE	CODE
Softer Seat Foam-Loveseat	32.00	SF

### 8803 Three-Seat Sofa

63" W X 25" D X 31.5" H

St. Yardage: 7.5

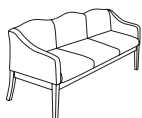

FREIGHT CLASS: 250  
CUBIC FT: 54  
SHIP WEIGHT: 82

**QS**

Grade	1	2	3	4	5	6	7	8	9	10	L	LL
Zone 1	1916	2104	2294	2497	2680	2925	3019	3414	3659	3964	4492	5421
Zone 2	1945	2136	2328	2534	2720	2969	3064	3465	3714	4023	4559	5502
Zone 3	1973	2167	2363	2572	2760	3013	3110	3516	3769	4083	4627	5584

- Sloped arm design with camel backs
- See features in series overview above
- Seat: 60"W x 20"D x 20"H

OPTION	PRICE	CODE
Softer Seat Foam-Sofa	48.00	SF



## FINISH SELECTION

ASPEN **AP** | BLACK **BLK** | NATURAL **FM** | HONEY CHERRY **HCY** | ROUGE MAHOGANY **RM** | MAHOGANY **MAH** | MOAB **MOB** | PEARWOOD **PW** | WALNUT **WAL** | WINDSOR CHERRY **WC** | SIN 711-16 CLASSIC CHERRY **CCY** | ESPRESSO **ESP** |

# HILEG CONFERENCE

GUEST

### Synthesis of High Comfort + Elegant Design

**HiLeg Conference** is the synthesis of high-comfort reception/lounge seating and wood leg chair designs. Fully upholstered seats, backs and arms feature scale and materials for generous comfort. Choose from four distinct designs. All rest on a solid hardwood leg base available in any finish, standard or custom.

### HiLeg Conference Details

- 4 distinct choices of back and arm profiles
- Solid hardwood base and legs
- Fully upholstered seat and back
- All chairs feature Black dual-wheel carpet casters. Other caster options available.



**8504 Chair**  
Radius Back and Arm Profile

## HiLeg Conference

### 8504 Conference Chair

25" W X 25" D X 31.5" H

St. Yardage: 4.25

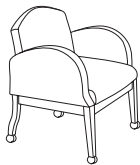

FREIGHT CLASS: 250  
CUBIC FT: 19  
SHIP WEIGHT: 47

**QS**

Grade	1	2	3	4	5	6	7	8	9	10	L	LL
Zone 1	1276	1339	1402	1470	1531	1612	1644	1775	1857	1959	2134	2611
Zone 2	1295	1359	1423	1492	1554	1636	1669	1802	1885	1988	2166	2650
Zone 3	1314	1379	1444	1514	1577	1660	1693	1828	1913	2018	2198	2689

- Radius back/arms
- Casters for mobility
- See features in series overview above
- Seat: 20.25"W x 20"D x 20"H

OPTION	PRICE	CODE
Softer Seat Foam-Chair	16.00	SF
CASTER OPTION	PRICE	CODE
Self-Locking Casters	85.00	S
Braking Casters	30.00	B
Hard-Floor Casters	19.00	H
Glides	N/C	GL

### 8604 Conference Chair

25" W X 25" D X 31" H

St. Yardage: 4.25

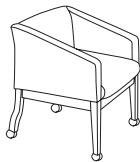

FREIGHT CLASS: 250  
CUBIC FT: 19  
SHIP WEIGHT: 48

**QS**

Grade	1	2	3	4	5	6	7	8	9	10	L	LL
Zone 1	1153	1216	1278	1347	1408	1489	1521	1652	1734	1836	2010	2488
Zone 2	1170	1234	1297	1367	1429	1511	1544	1677	1760	1864	2040	2525
Zone 3	1188	1252	1316	1387	1450	1534	1567	1702	1786	1891	2070	2563

- Slant arm design with straight back
- Casters for mobility
- See features in series overview above
- Seat: 20.25"W x 20"D x 20"H

OPTION	PRICE	CODE
Softer Seat Foam-Chair	16.00	SF
CASTER OPTION	PRICE	CODE
Self-Locking Casters	85.00	S
Braking Casters	30.00	B
Hard-Floor Casters	19.00	H
Glides	N/C	GL

ALL FOAM & FABRICS USED ARE CAL 117 APPROVED

**QS** indicates a Quickship item if ordered in Quickship upholstery. Quick Ship is not available on any item ordered with options.

# HILEG CONFERENCE

SIN 711-16

## FINISH SELECTION

ASPEN **AP** | BLACK **BLK** | NATURAL **FM** | HONEY CHERRY **HCY** | ROUGE MAHOGANY **RM** | MAHOGANY **MAH** | MOAB **MOB** | PEARWOOD **PW** | WALNUT **WAL** | WINDSOR CHERRY **WC** | CLASSIC CHERRY **CCY** | ESPRESSO **ESP** |

GUEST

### 8704 Conference Chair

25" W X 25" D X 31.5" H

St. Yardage: 4.25

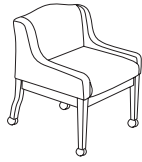

FREIGHT CLASS: 250  
CUBIC FT: 19  
SHIP WEIGHT: 44

**QS**

Grade	1	2	3	4	5	6	7	8	9	10	L	LL
Zone 1	1153	1216	1278	1347	1408	1489	1521	1652	1734	1836	2010	2488
Zone 2	1170	1234	1297	1367	1429	1511	1544	1677	1760	1864	2040	2525
Zone 3	1188	1252	1316	1387	1450	1534	1567	1702	1786	1891	2070	2563

- Low arm design with camel back
- Casters for mobility
- See features in series overview above
- Seat: 20.25"W x 20"D x 20"H

OPTION	PRICE	CODE
Softer Seat Foam-Chair	16.00	SF
CASTER OPTION	PRICE	CODE
Self-Locking Casters	85.00	S
Braking Casters	30.00	B
Hard-Floor Casters	19.00	H
Glides	N/C	GL

### 8804 Conference Chair

25" W X 25" D X 31.5" H

St. Yardage: 4.25

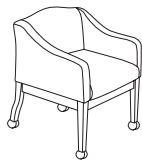

FREIGHT CLASS: 250  
CUBIC FT: 19  
SHIP WEIGHT: 49

**QS**

Grade	1	2	3	4	5	6	7	8	9	10	L	LL
Zone 1	1276	1339	1402	1470	1531	1612	1644	1775	1857	1959	2134	2611
Zone 2	1295	1359	1423	1492	1554	1636	1669	1802	1885	1988	2166	2650
Zone 3	1314	1379	1444	1514	1577	1660	1693	1828	1913	2018	2198	2689

- Sloped arm design with camel back
- Casters for mobility
- See features in series overview above
- Seat: 20.25"W x 20"D x 20"H

OPTION	PRICE	CODE
Softer Seat Foam-Chair	16.00	SF
CASTER OPTION	PRICE	CODE
Self-Locking Casters	85.00	S
Braking Casters	30.00	B
Hard-Floor Casters	19.00	H
Glides	N/C	GL

## FINISH SELECTION

ASPEN **AP** | BLACK **BLK** | NATURAL **FM** | HONEY CHERRY **HCY** | ROUGE MAHOGANY **RM** | MAHOGANY **MAH** | MOAB **MOB** | PEARWOOD **PW** | WALNUT **WAL** | WINDSOR CHERRY **WC** | CLASSIC CHERRY **CCY** | ESPRESSO **ESP** | MEDIUM OAK **OAK** | NATURAL OAK **NOK** |

# SIN VARIOUS GUEST CHAIRS

GUEST

### Stacking and Armchair Selections

These stacking and armchair collections provide sturdy construction at great value. Select from metal tubular frame chairs or wood framed chairs and armchairs.

### Guest & Stacking Features

- **700s**— Metal stack chairs with upholstered seat and back. Stacking cart available
- **990s**— Hardwood frame. Includes stacking, ganging and armchair models
- **9100s**— Non-stacking hardwood frame armchairs. Choose from open armed and closed arm design



712 Stacking Chair



993 Stacking Arm Chair



9128 and 9118 Arm Chairs

## Guest Chairs

### 712 Armless Metal Stacking Guest Chair

20" W X 23.25" D X 32" H

St. Yardage: 1.5



FREIGHT CLASS: 250  
CUBIC FT: 14  
SHIP WEIGHT: 38

Grade	1	2	3	4	5	6	7	8	9	10	L	LL
Zone 1	514	566	621	650	693	710	780	824	878	981	1195	1326
Zone 2	522	574	630	660	703	721	792	836	891	996	1213	1346
Zone 3	529	583	640	670	714	731	803	849	904	1010	1231	1366

- Powder coated black frame
- 1" tubular frame (16 gauge steel)
- Stacks 8 high

- Ships 2 per carton; list price is for single chair
- Seat: 18.5"W x 19"D x 18"H

Single Pack Specifications: Freight Class: 300 Cubes: 12 Ship Wt: 22

QS

SIN #711-19

### 713 Metal Stacking Guest Chair

24" W X 23.25" D X 32" H

St. Yardage: 1.5



FREIGHT CLASS: 250  
CUBIC FT: 14  
SHIP WEIGHT: 44

Grade	1	2	3	4	5	6	7	8	9	10	L	LL
Zone 1	556	610	664	692	735	752	783	822	866	920	1239	1368
Zone 2	564	619	674	702	746	763	795	834	879	934	1258	1389
Zone 3	573	628	684	713	757	775	806	847	892	948	1276	1409

- Black urethane arms
- Powder coated black frame
- 1" tubular frame (16 gauge steel)

- Stacks 8 high
- Ships 2 per carton; list price is for single chair
- Seat: 18.5"W x 19"D x 18"H

Single Pack Specifications: Freight Class: 300 Cubes: 12 Ship Wt: 23

QS

SIN #711-19

### 714 Metal Sled Base Guest Chair

24" W X 23.25" D X 32" H

St. Yardage: 1.5



FREIGHT CLASS: 250  
CUBIC FT: 14  
SHIP WEIGHT: 29

Grade	1	2	3	4	5	6	7	8	9	10	L	LL
Zone 1	577	633	683	713	740	756	773	843	887	941	1260	1389
Zone 2	586	642	693	724	751	767	785	856	900	955	1279	1410
Zone 3	594	652	703	734	762	779	796	868	914	969	1298	1431

- Sled base frame does NOT stack
- 1" tubular steel (16 gauge)
- Black powdercoat finish
- Flexible seat suspension

- Black urethane arms
- Ships 1 per carton
- Seat: 18.5"W x 19"D x 18"H

QS

SIN #711-18

ALL FOAM & FABRICS USED ARE CAL 117 APPROVED

QS indicates a Quickship item if ordered in Quickship upholstery. Quick Ship is not available on any item ordered with options.

# GUEST CHAIRS SIN VARIOUS

## FINISH SELECTION

ASPEN **AP** | BLACK **BLK** | NATURAL **FM** | HONEY CHERRY **HCY** | ROUGE MAHOGANY **RM** | MAHOGANY **MAH** | MOAB **MOB** | PEARWOOD **PW** | WALNUT **WAL** | WINDSOR CHERRY **WC** | CLASSIC CHERRY **CCY** | ESPRESSO **ESP** |

GUEST

### 715-CART Metal Cart



- Holds up to eight 712 & 713 stacking chairs
- Holds up to five 992 & 993 stacking chairs
- Powder coated black steel frame
- Dual wheel casters

FREIGHT CLASS: 85

		Zone Pricing	1	2	3
26" W X 24" D X 6" H	Cubic Ft: 4 Ship Weight: 19		<b>301</b>	<b>306</b>	<b>310</b>
		<b>SIN #711-19</b>			

**QS**

### 992 Armless Stacking/Ganging Side Chair



FREIGHT CLASS: 250  
CUBIC FT: 15  
SHIP WEIGHT: 48

22" W X 25" D X 34" H St. Yardage: 1

Grade	1	2	3	4	5	6	7	8	9	10	L	LL
<b>Zone 1</b>	<b>577</b>	<b>610</b>	<b>645</b>	<b>662</b>	<b>689</b>	<b>700</b>	<b>721</b>	<b>743</b>	<b>771</b>	<b>805</b>	<b>1007</b>	<b>1122</b>
<b>Zone 2</b>	<b>586</b>	<b>619</b>	<b>655</b>	<b>672</b>	<b>699</b>	<b>711</b>	<b>732</b>	<b>754</b>	<b>783</b>	<b>817</b>	<b>1022</b>	<b>1139</b>
<b>Zone 3</b>	<b>594</b>	<b>628</b>	<b>664</b>	<b>682</b>	<b>710</b>	<b>721</b>	<b>743</b>	<b>765</b>	<b>794</b>	<b>829</b>	<b>1037</b>	<b>1156</b>

- Hardwood frame
- Stacks 5 high
- Ships 2 per carton; list price is for single chair
- Each chair adds 5.5" when stacking
- Seat: 19"W x 20"D x 19"H

**SIN #711-19**

**QS**

### 993 Stacking/Ganging Guest Chair



FREIGHT CLASS: 250  
CUBIC FT: 15  
SHIP WEIGHT: 48

22" W X 25" D X 34" H St. Yardage: 1

Grade	1	2	3	4	5	6	7	8	9	10	L	LL
<b>Zone 1</b>	<b>577</b>	<b>610</b>	<b>645</b>	<b>662</b>	<b>689</b>	<b>700</b>	<b>721</b>	<b>743</b>	<b>771</b>	<b>805</b>	<b>1007</b>	<b>1122</b>
<b>Zone 2</b>	<b>586</b>	<b>619</b>	<b>655</b>	<b>672</b>	<b>699</b>	<b>711</b>	<b>732</b>	<b>754</b>	<b>783</b>	<b>817</b>	<b>1022</b>	<b>1139</b>
<b>Zone 3</b>	<b>594</b>	<b>628</b>	<b>664</b>	<b>682</b>	<b>710</b>	<b>721</b>	<b>743</b>	<b>765</b>	<b>794</b>	<b>829</b>	<b>1037</b>	<b>1156</b>

- Hardwood frame
- Stacks 5 high
- Ships 2 per carton; list price is for single chair
- Each chair adds 5.5" when stacking
- Seat: 19"W x 20"D x 19"H

**SIN #711-19**

**QS**

### 935 Arm Chair



FREIGHT CLASS: 250  
CUBIC FT: 15  
SHIP WEIGHT: 26

22.5" W X 26.5" D X 34" H St. Yardage: 2.5

Grade	1	2	3	4	5	6	7	8	9	10	L	LL
<b>Zone 1</b>	<b>863</b>	<b>931</b>	<b>996</b>	<b>1033</b>	<b>1087</b>	<b>1108</b>	<b>1196</b>	<b>1250</b>	<b>1318</b>	<b>1447</b>	<b>1717</b>	<b>1953</b>
<b>Zone 2</b>	<b>876</b>	<b>945</b>	<b>1011</b>	<b>1048</b>	<b>1103</b>	<b>1125</b>	<b>1214</b>	<b>1269</b>	<b>1338</b>	<b>1469</b>	<b>1743</b>	<b>1982</b>
<b>Zone 3</b>	<b>889</b>	<b>959</b>	<b>1026</b>	<b>1064</b>	<b>1120</b>	<b>1141</b>	<b>1232</b>	<b>1288</b>	<b>1358</b>	<b>1490</b>	<b>1769</b>	<b>2012</b>

- Hardwood frames
- Available in the finishes above except Medium Oak (OAK) and Natural Oak (NOK)
- Seat: 20.5"W x 18"D x 20"H

**SIN #711-18**

**QS**

### 9118 Arm Chair



FREIGHT CLASS: 250  
CUBIC FT: 15  
SHIP WEIGHT: 26

23" W X 25.5" D X 33" H St. Yardage: 2

Grade	1	2	3	4	5	6	7	8	9	10	L	LL
<b>Zone 1</b>	<b>608</b>	<b>666</b>	<b>718</b>	<b>737</b>	<b>778</b>	<b>832</b>	<b>853</b>	<b>941</b>	<b>995</b>	<b>1063</b>	<b>1287</b>	<b>1498</b>
<b>Zone 2</b>	<b>617</b>	<b>676</b>	<b>729</b>	<b>748</b>	<b>790</b>	<b>844</b>	<b>866</b>	<b>955</b>	<b>1010</b>	<b>1079</b>	<b>1306</b>	<b>1520</b>
<b>Zone 3</b>	<b>626</b>	<b>686</b>	<b>740</b>	<b>759</b>	<b>801</b>	<b>857</b>	<b>879</b>	<b>969</b>	<b>1025</b>	<b>1095</b>	<b>1326</b>	<b>1543</b>

- Hardwood frame
- Upholstered seat/back
- Available in all seating finishes
- Seat: 20.5"W x 17.25"D x 19"H

**SIN #711-18**

**QS**

### 9128 Arm Chair

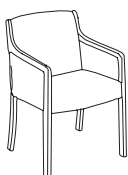

FREIGHT CLASS: 250  
CUBIC FT: 15  
SHIP WEIGHT: 29

23" W X 25.5" D X 33" H St. Yardage: 2.5

Grade	1	2	3	4	5	6	7	8	9	10	L	LL
<b>Zone 1</b>	<b>709</b>	<b>780</b>	<b>844</b>	<b>879</b>	<b>933</b>	<b>954</b>	<b>1042</b>	<b>1096</b>	<b>1164</b>	<b>1293</b>	<b>1560</b>	<b>1699</b>
<b>Zone 2</b>	<b>720</b>	<b>792</b>	<b>857</b>	<b>892</b>	<b>947</b>	<b>968</b>	<b>1058</b>	<b>1112</b>	<b>1181</b>	<b>1312</b>	<b>1583</b>	<b>1724</b>
<b>Zone 3</b>	<b>730</b>	<b>803</b>	<b>869</b>	<b>905</b>	<b>961</b>	<b>983</b>	<b>1073</b>	<b>1129</b>	<b>1199</b>	<b>1332</b>	<b>1607</b>	<b>1750</b>

- Hardwood frame
- Upholstered seat/back
- Upholstered side panels
- Available in all seating finishes
- Seat: 20.5"W x 17.25"D x 19"H

**SIN #711-18**

**QS**

# FINISH SELECTION

ASPEN **AP** | BLACK **BLK** | NATURAL **FM** | HONEY CHERRY **HCY** | ROUGE MAHOGANY **RM** | MAHOGANY **MAH** | MOAB **MOB** | PEARWOOD **PW** | WALNUT **WAL** | WINDSOR CHERRY **WC** | CLASSIC CHERRY **CCY** | ESPRESSO **ESP** | MEDIUM OAK **OAK** | NATURAL OAK **NOK** |

SIN VARIOUS **UNOS**

GUEST

## Solid Comfort

The **Unos** collection is constructed with extremely sturdy frames in a transitional design. Steel cross braces provide solid construction with a weight capacity of 350 lb. per unity. Bariatric width chairs also include steel cross braces in the back and offer standard weight capacity of 500 lb. with a 750 lb. and 1,000 lb. option.

## Design Details

- Extra wide arms with scalloped design
- Separated seats and backs for easy clean out
- Steel Reinforced seat frame
- Backs have hook and loop fasteners for easy field replacements
- Seats are field replaceable
- Wall saver leg design
- Adjustable glides



Unos Arm Chair 904



905 High Back

## Unos

### 904 Armchair

24.75" W X 25.5" D X 35" H

St. Yardage: 2.5



FREIGHT CLASS: 250  
CUBIC FT: 15  
SHIP WEIGHT: 38

Grade	1	2	3	4	5	6	7	8	9	10	L	LL
Zone 1	843	884	931	977	1019	1075	1131	1187	1244	1314	1434	1764
Zone 2	856	897	945	992	1034	1091	1148	1205	1263	1334	1456	1790
Zone 3	868	910	959	1006	1050	1107	1165	1223	1281	1353	1477	1817

- Extra sturdy solid hardwood frame
- Transitional style 2" wide scalloped arms/legs

- Separated upholstered seat and back for easy cleanout
- Steel reinforced seat frame
- Weight capacity of 350 lbs
- Seat: 20"W x 19"D x 18"H

OPTION	PRICE	CODE
Black Polyurethane Arm Caps	86.00	PC

QS

SIN #711-16

### 906 Two-Seat Settee

50" W X 25.5" D X 35" H

St. Yardage: 3.5

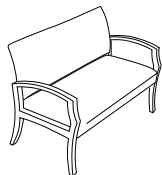

FREIGHT CLASS: 175  
CUBIC FT: 36  
SHIP WEIGHT: 69

Grade	1	2	3	4	5	6	7	8	9	10	L	LL
Zone 1	1191	1249	1316	1380	1440	1520	1599	1679	1758	1858	2028	2495
Zone 2	1209	1267	1336	1401	1462	1543	1623	1704	1784	1886	2059	2532
Zone 3	1227	1286	1356	1421	1483	1566	1647	1729	1811	1914	2089	2570

- Extra sturdy solid hardwood frame
- Transitional style 2" wide scalloped arms/legs

- Separated upholstered seat and back for easy cleanout
- Steel reinforced seat frame
- Weight capacity of 350 lbs
- Seat: 45"W x 19"D x 18"H

OPTION	PRICE	CODE
Black Polyurethane Arm Caps	86.00	PC

QS

SIN #711-16

### 908 Bench

50" W X 25.5" D X 25.5" H

St. Yardage: 2

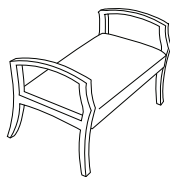

FREIGHT CLASS: 175  
CUBIC FT: 36  
SHIP WEIGHT: 69

Grade	1	2	3	4	5	6	7	8	9	10	L	LL
Zone 1	953	994	1041	1087	1129	1185	1241	1297	1354	1424	1544	1874
Zone 2	967	1009	1057	1103	1146	1203	1260	1316	1374	1445	1567	1902
Zone 3	982	1024	1073	1120	1163	1221	1278	1336	1395	1467	1590	1930

- 48" bench with extra sturdy solid hardwood frame
- Transitional style 2" wide scalloped arms/legs

- Reinforced seat frame with steel cross braces
- Weight capacity of 350 lbs
- Seat: 45"W x 19"D x 18"H

OPTION	PRICE	CODE
Black Polyurethane Arm Caps	86.00	PC

QS

SIN #711-16

ALL FOAM & FABRICS USED ARE CAL 117 APPROVED

**QS** indicates a Quickship item if ordered in Quickship upholstery. Quick Ship is not available on any item ordered with options.

## FINISH SELECTION

ASPEN **AP** | BLACK **BLK** | NATURAL **FM** | HONEY CHERRY **HCY** | ROUGE MAHOGANY **RM** | MAHOGANY **MAH** | MOAB **MOB** | PEARWOOD **PW** | WALNUT **WAL** | WINDSOR CHERRY **WC** | CLASSIC CHERRY **CCY** | ESPRESSO **ESP** |

GUEST

### 902 Bariatric Chair, 30" Wide Seat

35" W X 25.5" D X 35" H

St. Yardage: 3

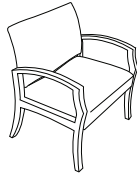

FREIGHT CLASS: 175  
CUBIC FT: 36  
SHIP WEIGHT: 65

Grade	1	2	3	4	5	6	7	8	9	10	L	LL
<b>Zone 1</b>	1305	1356	1415	1472	1525	1595	1665	1735	1806	1894	2044	2456
<b>Zone 2</b>	1325	1376	1437	1494	1548	1619	1690	1761	1833	1922	2074	2493
<b>Zone 3</b>	1344	1397	1458	1516	1571	1643	1715	1787	1860	1951	2105	2530

- Bariatric chair with 30" wide seat
- Extra sturdy solid hardwood frame
- Transitional style 2" wide scalloped arms/legs
- Separated upholstered seat and back for easy cleanout
- Reinforced seat frame with steel cross braces
- Weight capacity of 500 lbs
- Seat: 30" W x 19" D x 18" H

OPTION	PRICE	CODE
750 lb. Bariatric Rating	130.00	HB
1000 lb. Bariatric Rating	250.00	XB
Black Polyurethane Arm Caps	86.00	PC

**QS**

SIN #71-316

### 903 Bariatric Chair, 40" Wide Seat

45" W X 25.5" D X 35" H

St. Yardage: 3.25

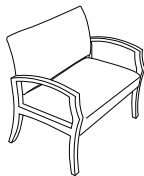

FREIGHT CLASS: 175  
CUBIC FT: 36  
SHIP WEIGHT: 86

Grade	1	2	3	4	5	6	7	8	9	10	L	LL
<b>Zone 1</b>	1441	1495	1559	1619	1675	1750	1825	1900	1975	2069	2229	2669
<b>Zone 2</b>	1463	1518	1582	1643	1700	1776	1852	1929	2005	2100	2262	2709
<b>Zone 3</b>	1484	1540	1606	1668	1725	1803	1880	1957	2034	2131	2296	2749

- Bariatric chair with 40" wide seat
- Extra sturdy solid hardwood frame
- Transitional style 2" wide scalloped arms/legs
- Separated upholstered seat and back for easy cleanout
- Reinforced seat frame with steel cross braces
- Weight capacity of 500 lbs
- Seat: 40" W x 19" D x 18" H

OPTION	PRICE	CODE
750 lb. Bariatric Rating	130.00	HB
1000 lb. Bariatric Rating	250.00	XB
Black Polyurethane Arm Caps	86.00	PC

**QS**

SIN #71-316

### 905 High Back Patient's Chair

24.75" W X 25.5" D X 46" H

St. Yardage: 3



FREIGHT CLASS: 300  
CUBIC FT: 23  
SHIP WEIGHT: 45

Grade	1	2	3	4	5	6	7	8	9	10	L	LL
<b>Zone 1</b>	911	962	1021	1078	1131	1201	1271	1341	1412	1500	1650	2062
<b>Zone 2</b>	925	976	1036	1094	1148	1219	1290	1361	1433	1523	1675	2093
<b>Zone 3</b>	938	991	1052	1110	1165	1237	1309	1381	1454	1545	1699	2124

- Extra sturdy solid hardwood frame
- Transitional style 2" wide scalloped arms/legs
- Upholstered seat and back
- Reinforced seat frame with steel cross braces
- Weight capacity of 350 lbs
- Add rocking motion with flex back or flex seat/back by choosing motion options (adds 15 lb. to weight)
- Seat: 20" W x 19" D x 18" H

OPTION	PRICE	CODE
Motion Seat & Back	268.00	-60
Motion Back Only	259.00	-65
Black Polyurethane Arm Caps	86.00	PC

**QS**

SIN #71-317

### 910 Sloped Ottoman

18.5" W X 19" D X 11.5" H

St. Yardage: 1

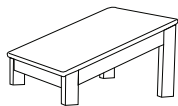

FREIGHT CLASS:  
CUBIC FT: 6  
SHIP WEIGHT: 17

Grade	1	2	3	4	5	6	7	8	9	10	L	LL
<b>Zone 1</b>	642	656	671	687	701	719	738	757	776	799	839	949
<b>Zone 2</b>	652	666	681	697	712	730	749	768	788	811	852	963
<b>Zone 3</b>	661	676	691	708	722	741	760	780	799	823	864	977

- Extra sturdy hardwood frame
- Upholstered padded top
- Can be turned with angle toward seat or away from seat

**QS**

SIN #71-317



# FINISH SELECTION

ASPEN AP | BLACK BLK | HONEY CHERRY HCY | ROUGE MAHOGANY RM | MAHOGANY MAH | MOAB MOB | PEARWOOD PW | WALNUT WAL | WINDSOR CHERRY WC | CLASSIC CHERRY CCY | ESPRESSO ESP |

SIN VARIOUS **TRADOS**

GUEST

## Solid Comfort

The **Trados** collection features a striking triarc arm design and a solid frame. Steel cross brace construction provides 350 lb. capacity. Bariatric width chairs also include steel cross braces in the back and offer standard weight capacity of 500 lb. with a 750 lb. and 1,000 lb. option.

## Design Details

- *Triarc arm design*
- *Bariatric seating is rated to 500 lb. standard*
- *Clean out feature*
- *Reinforced seat frame*
- *Backs have hook and loop fasteners for easy field replacements*
- *Field replaceable seats*



914 Arm Chair



916 Two Seat Settee



918 Bench

## Trados

### 914 Armchair

22.75" W X 25" D X 35" H

St. Yardage: 2.5

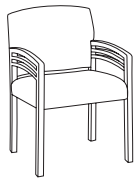

FREIGHT CLASS: 300  
CUBIC FT: 15  
SHIP WEIGHT: 35

Grade	1	2	3	4	5	6	7	8	9	10	L	LL
Zone 1	728	792	855	869	913	973	1032	1091	1150	1225	1544	1699
Zone 2	739	804	868	882	927	988	1047	1107	1167	1243	1567	1724
Zone 3	750	816	881	895	940	1002	1063	1124	1185	1262	1590	1750

- Solid wood frame
- Triarc arm design
- Separated upholstered seat and back for easy cleanout
- Steel reinforced seat frame
- Weight capacity of 350 lbs
- Seat: 20"W x 19"D x 18"H

OPTION	PRICE	CODE
Black Polyurethane Arm Caps	80.00	PC
Casters for Guest Chairs	50.00	C

Single Pack Specifications: Freight Class: 300 Cubes: 12 Ship Wt: 22

**QS**

SIN #711-16

### 916 Two-Seat Settee

48" W X 25" D X 35" H

St. Yardage: 3.75

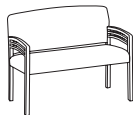

FREIGHT CLASS: 175  
CUBIC FT: 37  
SHIP WEIGHT: 64

Grade	1	2	3	4	5	6	7	8	9	10	L	LL
Zone 1	1167	1248	1333	1366	1429	1513	1597	1681	1765	1870	2212	2542
Zone 2	1185	1267	1353	1386	1450	1536	1621	1706	1791	1898	2245	2580
Zone 3	1202	1285	1373	1407	1472	1558	1645	1731	1818	1926	2278	2618

- Solid wood frame
- Triarc arm design
- Separated upholstered seat and back for easy cleanout
- Steel reinforced seat frame
- Weight capacity of 350 lbs
- Seat: 45"W x 19"D x 18"H

OPTION	PRICE	CODE
Black Polyurethane Arm Caps	80.00	PC

**QS**

SIN #711-16

### 918 Bench

48" W X 22" D X 25.5" H

St. Yardage: 2

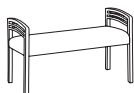

FREIGHT CLASS: 175  
CUBIC FT: 36  
SHIP WEIGHT: 69

Grade	1	2	3	4	5	6	7	8	9	10	L	LL
Zone 1	903	920	937	966	1031	1135	1191	1247	1304	1347	1164	1507
Zone 2	917	934	951	980	1046	1152	1209	1266	1324	1367	1181	1530
Zone 3	930	948	965	995	1062	1169	1227	1284	1343	1387	1199	1552

- Solid wood frame
- Triarc arm design
- Separated upholstered seat and back for easy cleanout
- Steel reinforced seat frame
- Weight capacity of 350 lbs
- Seat: 45"W x 19"D x 18"H

OPTION	PRICE	CODE
Black Polyurethane Arm Caps	80.00	PC

**QS**

SIN #711-16

ALL FOAM & FABRICS USED ARE CAL 117 APPROVED

**QS** indicates a Quickship item if ordered in Quickship upholstery. Quick Ship is not available on any item ordered with options.

## FINISH SELECTION

ASPEN AP | BLACK BLK | HONEY CHERRY HCY | ROUGE MAHOGANY RM |  
 MAHOGANY MAH | MOAB MOB | PEARWOOD PW | WALNUT WAL | WINDSOR CHERRY WC |  
 CLASSIC CHERRY CCY | ESPRESSO ESP |

GUEST

### 912 30" Bariatric Chair

33" W X 25" D X 35" H

St. Yardage: 3

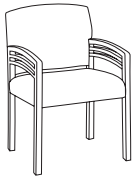

FREIGHT CLASS: 175  
 CUBIC FT: 36  
 SHIP WEIGHT: 65

Grade	1	2	3	4	5	6	7	8	9	10	L	LL
Zone 1	932	969	1001	1074	1152	1222	1292	1362	1433	1521	1418	2083
Zone 2	946	984	1016	1090	1169	1240	1311	1382	1454	1544	1439	2114
Zone 3	960	998	1031	1106	1187	1259	1331	1403	1476	1567	1461	2145

- Wood frame
- Triarc arm design
- Separated upholstered seat and back for easy cleanout
- Steel reinforced seat and back frame
- Weight capacity of 500 lbs
- Seat: 30"W x 19"D x 18"H

OPTION	PRICE	CODE
Black Polyurethane Arm Caps	80.00	PC
750 lb. Bariatric Rating	130.00	HB
1000 lb. Bariatric Rating	250.00	XB

QS

SIN #71-316

### 913 40" Bariatric Chair

43" W X 25" D X 35" H

St. Yardage: 3.5

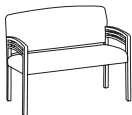

FREIGHT CLASS: 175  
 CUBIC FT: 36  
 SHIP WEIGHT: 81

Grade	1	2	3	4	5	6	7	8	9	10	L	LL
Zone 1	1049	1091	1136	1223	1283	1358	1433	1508	1583	1677	1642	2227
Zone 2	1065	1107	1153	1241	1302	1378	1454	1531	1607	1702	1667	2260
Zone 3	1080	1124	1170	1260	1321	1399	1476	1553	1630	1727	1691	2294

- Wood frame
- Triarc arm design
- Separated upholstered seat and back for easy cleanout
- Steel reinforced seat and back frame
- Weight capacity of 500 lbs
- Seat: 40"W x 19"D x 18"H

OPTION	PRICE	CODE
Black Polyurethane Arm Caps	80.00	PC
750 lb. Bariatric Rating	130.00	HB
1000 lb. Bariatric Rating	250.00	XB

QS

SIN #71-316

### 915 High Back Patient's Chair

22.75" W X 25" D X 46" H

St. Yardage: 3



FREIGHT CLASS: 300  
 CUBIC FT: 24  
 SHIP WEIGHT: 43

Grade	1	2	3	4	5	6	7	8	9	10	L	LL
Zone 1	815	857	903	982	1035	1105	1175	1245	1316	1404	1408	1966
Zone 2	827	870	917	997	1051	1122	1193	1264	1336	1425	1429	1995
Zone 3	839	883	930	1011	1066	1138	1210	1282	1355	1446	1450	2025

- Wood frame
- Triarc arm design
- Upholstered seat and back
- Steel reinforced seat frame
- Weight capacity of 350 lbs
- Add rocking motion with flex back or flex back/seat by choosing motion options (adds 15 lb. to weight)
- Seat: 20"W x 19"D x 18"H

OPTION	PRICE	CODE
Black Polyurethane Arm Caps	80.00	PC
Casters for Guest Chairs	50.00	C
Motion Seat & Back	368.00	-60
Motion Back Only	259.00	-65

QS

SIN #71-317

### 920 Hip Chair

23" W X 24.5" D X 43" H

St. Yardage: 2.25

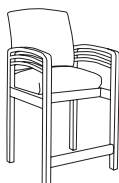

FREIGHT CLASS: 300  
 CUBIC FT: 24  
 SHIP WEIGHT: 45

Grade	1	2	3	4	5	6	7	8	9	10	L	LL
Zone 1	1739	1771	1803	1867	1915	1971	2025	2083	2140	2210	2171	2660
Zone 2	1765	1798	1830	1895	1944	2001	2055	2114	2172	2243	2204	2700
Zone 3	1791	1824	1857	1923	1972	2030	2086	2145	2204	2276	2236	2740

- Wood frame
- Upholstered seat/back
- Clean out feature
- Seat height at 25.5"
- Step at 6.5" from floor.
- 14" deep seat is recessed 5.5" from front of chair to prevent occupants full weight from resting on the hips
- Seat: 20"W x 14"D x 25.5"H

OPTION	PRICE	CODE
Black Polyurethane Arm Caps	80.00	PC

QS

SIN #71-317

QS

ALL FOAM & FABRICS USED ARE CAL 117 APPROVED  
 indicates a Quickship item if ordered in Quickship upholstery.  
 Quick Ship is not available on any item ordered with options.

**Solid Comfort, Modern Metal**

The **Trados Metal** guest seating collection features a triarc arm design enhanced by a smooth silver finish frame. Other finishes available at a 15% upcharge. Minimum 50 seat order. Contact customer service for a list of finishes available. This elegant yet sturdy chair can be further enhanced by the addition of the optional wood or urethane arm caps.

Steel cross brace construction and a heavy gauge steel frame provide 350 lb. capacity. Bariatric seating also includes steel cross brace in back and is rated to 500 lb. with a 750 lb. and 1,000 lb. option.

**Trados Metal Design Details**

- *Triarc arm design*
- *Bariatric seating is rated to 500 lb. standard*
- *Collection includes patient seating and ganging waiting area seating*
- *Clean-out feature*
- *Reinforced seat frame*

**Additional options**

- *Wood or Black Polyurethane arm caps*
- *Twelve finish selections available with wood arm cap*



914MET

STANDARD ORDER: SPECIFICATION DETAIL

**914MET**

**AP**

Base Model

OPTIONAL  
wood arm cap

**Please Note:** If optional Wood arm cap is selected, add the finish code of your choice to the end of the model number. Polyurethane arm is only available in black; no color code is required.

**Trados Metal**

**914MET Armchair**

22.75" W X 25" D X 35" H

St. Yardage: 2.5

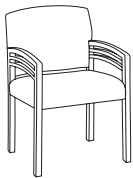

FREIGHT CLASS: 250  
CUBIC FT: 15  
SHIP WEIGHT: 45

Grade	1	2	3	4	5	6	7	8	9	10	L	LL
<b>Zone 1</b>	833	878	932	967	1009	1065	1121	1177	1234	1304	1494	1754
<b>Zone 2</b>	845	891	946	982	1024	1081	1138	1195	1253	1324	1516	1780
<b>Zone 3</b>	858	904	960	996	1039	1097	1155	1212	1271	1343	1539	1807

	OPTION	PRICE	CODE
• Metal Triarc arms/legs			
• Separated upholstered seat and back for easy cleanout			
• Steel reinforced seat frame			
• Weight capacity of 350 lbs			
• Optional wood arm caps available in all seating finishes except OAK and NOK			
• Seat: 20"W x 19"D x 18"H			
	Black Polyurethane Arm Caps	80.00	PC
	Wood Arm Caps, Specify Finish	80.00	WA

**QS**

SIN #711-16

**916MET Two-Seat Settee**

48" W X 25" D X 35" H

St. Yardage: 3.75

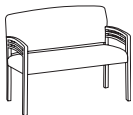

FREIGHT CLASS: 175  
CUBIC FT: 37  
SHIP WEIGHT: 82

Grade	1	2	3	4	5	6	7	8	9	10	L	LL
<b>Zone 1</b>	1338	1402	1478	1527	1587	1667	1746	1826	1905	2005	2273	2642
<b>Zone 2</b>	1358	1423	1500	1550	1611	1692	1772	1853	1934	2035	2307	2682
<b>Zone 3</b>	1378	1444	1522	1573	1635	1717	1798	1881	1962	2065	2341	2721

	OPTION	PRICE	CODE
• Metal Triarc arms/legs			
• Separated upholstered seat and back for easy cleanout			
• Steel reinforced seat frame			
• Weight capacity of 350 lbs			
• Optional wood arm caps available in all seating finishes except OAK and NOK			
• Seat: 45"W x 19"D x 18"H			
	Black Polyurethane Arm Caps	80.00	PC
	Wood Arm Caps, Specify Finish	80.00	WA

**QS**

SIN #711-16

**918MET Bench**

48" W X 22" D X 25.5" H

St. Yardage: 2

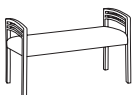

FREIGHT CLASS: 175  
CUBIC FT: 37  
SHIP WEIGHT: 74

Grade	1	2	3	4	5	6	7	8	9	10	L	LL
<b>Zone 1</b>	1034	1079	1133	1168	1210	1266	1322	1378	1435	1505	1695	1955
<b>Zone 2</b>	1050	1095	1150	1186	1228	1285	1342	1399	1457	1528	1720	1984
<b>Zone 3</b>	1065	1111	1167	1203	1246	1304	1362	1419	1478	1550	1746	2014

	OPTION	PRICE	CODE
• Metal Triarc arms/legs			
• Upholstered seat			
• Steel reinforced seat frame			
• Weight capacity of 350 lbs			
• Optional wood arm caps available in all seating finishes except OAK and NOK			
• Seat: 45"W x 21"D x 18"H			
	Black Polyurethane Arm Caps	80.00	PC
	Wood Arm Caps, Specify Finish	80.00	WA

**QS**

SIN #711-16

ALL FOAM & FABRICS USED ARE CAL 117 APPROVED

**QS** indicates a Quickship item if ordered in Quickship upholstery. Quick Ship is not available on any item ordered with options.

# TRADOS METAL SIN VARIOUS

GUEST

## 912MET 30" Bariatric Chair

33" W X 25" D X 35" H

St. Yardage: 3

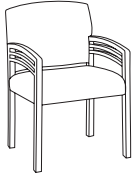

FREIGHT CLASS: 175  
CUBIC FT: 36  
SHIP WEIGHT: 68

Grade	1	2	3	4	5	6	7	8	9	10	L	LL
<b>Zone 1</b>	1068	1125	1191	1235	1288	1358	1428	1498	1569	1657	1894	2219
<b>Zone 2</b>	1084	1142	1209	1254	1307	1378	1449	1520	1593	1682	1922	2252
<b>Zone 3</b>	1100	1159	1227	1272	1327	1399	1471	1543	1616	1707	1951	2286

- Metal Triarc arms/legs
- Separated upholstered seat and back for easy cleanout
- Steel reinforced seat and back frame
- Weight capacity of 500 lbs
- Optional wood arm caps available in all seating finishes except OAK and NOK
- Seat: 30"W x 19"D x 18"H

OPTION	PRICE	CODE
Black Polyurethane Arm Caps	80.00	PC
Wood Arm Caps, Specify Finish	80.00	WA

OPTION	PRICE	CODE
750 lb. Bariatric Rating	130.00	HB
1000 lb. Bariatric Rating	250.00	XB

QS

SIN #71-316

## 913MET 40" Bariatric Chair

43" W X 25" D X 35" H

St. Yardage: 3.5

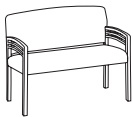

FREIGHT CLASS: 175  
CUBIC FT: 36  
SHIP WEIGHT: 89

Grade	1	2	3	4	5	6	7	8	9	10	L	LL
<b>Zone 1</b>	1201	1262	1333	1379	1435	1510	1585	1660	1735	1829	2082	2429
<b>Zone 2</b>	1219	1281	1353	1400	1457	1533	1609	1685	1761	1856	2113	2465
<b>Zone 3</b>	1237	1300	1373	1420	1478	1555	1633	1710	1787	1884	2144	2502

- Metal Triarc arms/legs
- Separated upholstered seat and back for easy cleanout
- Steel reinforced seat and back frame
- Weight capacity of 500 lbs
- Optional wood arm caps available in all seating finishes except OAK and NOK
- Seat: 40"W x 19"D x 18"H

OPTION	PRICE	CODE
Black Polyurethane Arm Caps	80.00	PC
Wood Arm Caps, Specify Finish	80.00	WA

OPTION	PRICE	CODE
750 lb. Bariatric Rating	130.00	HB
1000 lb. Bariatric Rating	250.00	XB

QS

SIN #71-316

## 915MET High-Back Patient's Chair

22.75" W X 25" D X 46" H

St. Yardage: 3



FREIGHT CLASS: 250  
CUBIC FT: 24  
SHIP WEIGHT: 52

Grade	1	2	3	4	5	6	7	8	9	10	L	LL
<b>Zone 1</b>	934	991	1057	1101	1154	1224	1294	1364	1435	1523	1760	2085
<b>Zone 2</b>	948	1006	1073	1118	1171	1242	1313	1384	1457	1546	1786	2116
<b>Zone 3</b>	962	1021	1089	1134	1189	1261	1333	1405	1478	1569	1813	2148

- Metal Triarc arms/legs
- Upholstered seat and back
- Steel reinforced seat frame
- Weight capacity of 350 lbs
- Optional wood arm caps available in all seating finishes except OAK and NOK
- Add rocking motion with flex back or flex back/seat by choosing motion options (adds 15 lb. to weight)
- Seat: 20"W x 19"D x 18"H

OPTION	PRICE	CODE
Black Polyurethane Arm Caps	80.00	PC
Wood Arm Caps, Specify Finish	80.00	WA

Motion Seat & Back	268.00	-60
Motion Back Only	259.00	-65

QS

SIN #71-317

**FINISH SELECTION**

ROUGE MAHOGANY **RM** | WINDSOR CHERRY **WC** | BLACK **BLK** | MOAB **MOB** |  
 HONEY CHERRY **HCY** | PEARWOOD **PW** | MAHOGANY **MAH** | ASPEN **AP** | SIN VARIOUS  
 ESPRESSO **ESP** | CLASSIC CHERRY **CCY** | WALNUT **WAL** |

# TRADITIONAL SERIES

TRADITIONAL OFFICE

**Traditional Style, Modern Value**

**Traditional Seating Series** features period influences to create Wing Back, Gooseneck and other classic styles. Traditional tufting, individually-placed brass nail trim and shaped wood basecaps enhance the design.

**Chair Details**

- Brass nail trim
- Traditional tufting is standard on most models
- Black, dual-wheel carpet casters

**Additional Options**

- Knee tilt control option
- Edge Guard option
- Non-Tufted option
- No Brass Trim option



4072 Loveseat



4075 Arm Chair



4053 Goose Neck Arm Chair



4074 Wing Back Arm Chair

**Traditional Series**

**4013 Captain's Arm Chair**



Freight Class: 250  
 Cubic Ft: 14  
 Ship Weight: 30

27" W X 25" D X 30" H

St. Yardage: 2

Grade	1	2	3	4	5	6	7	8	9	10	L	LL
Zone 1	813	867	918	949	992	1029	1079	1123	1177	1280	1494	1625
Zone 2	825	880	932	963	1007	1044	1095	1140	1195	1299	1516	1649
Zone 3	837	893	946	977	1022	1060	1111	1157	1212	1318	1539	1674

OPTION	PRICE	CODE
No Brass Trim Option	N/C	NB

- Brass nail head trim on back, arms and seat
- Padded platform arms
- Seat: 22"W x 20.5"D x 19"H

**QS**

**4016 Conference Chair**



Freight Class: 250  
 Cubic Ft: 14  
 Ship Weight: 30

27" W X 25" D X 29.5" H

St. Yardage: 2

Grade	1	2	3	4	5	6	7	8	9	10	L	LL
Zone 1	889	944	995	1025	1068	1085	1155	1199	1253	1356	1567	1701
Zone 2	902	958	1010	1040	1084	1101	1172	1217	1272	1376	1591	1727
Zone 3	916	972	1025	1056	1100	1118	1190	1235	1291	1397	1614	1752

OPTION	PRICE	CODE
No Brass Trim Option	N/C	NB
Hard-Floor Casters	19.00	H

- Brass nail head trim on back, arms and seat
- Padded platform arms
- Casters for mobility
- Seat: 22"W x 20.5"D x 19"H

**QS**

**4017 Management Swivel**



Freight Class: 150  
 Cubic Ft: 19  
 Ship Weight: 52

27" W X 25" D X 32-36" H

St. Yardage: 2

Grade	1	2	3	4	5	6	7	8	9	10	L	LL
Zone 1	1069	1130	1181	1205	1248	1265	1335	1379	1433	1536	1750	1881
Zone 2	1085	1147	1199	1223	1267	1284	1355	1400	1454	1559	1776	1909
Zone 3	1101	1164	1216	1241	1285	1303	1375	1420	1476	1582	1803	1937

OPTION	PRICE	CODE
Jury Base	315.00	JB
Knee Tilt Control	100.00	K
No Brass Trim Option	N/C	NB
CASTER OPTION	PRICE	CODE
Self-Locking Casters	85.00	S
Braking Casters	30.00	B
Hard-Floor Casters	19.00	H
Glides	N/C	GL

- Brass nail head trim on back, arms and seat
- Padded platform arms
- 5-prong steel base with hardwood caps
- Pneumatic seat-height adjustment
- Standard swivel tilt
- Seat: 22"W x 20.5"D x 21.5-25.5"H

**QS**

# TRADITIONAL SERIES

## FINISH SELECTION

ROUGE MAHOGANY **RM** | WINDSOR CHERRY **WC** | BLACK **BLK** | MOAB **MOB** |  
 HONEY CHERRY **HCY** | PEARWOOD **PW** | MAHOGANY **MAH** | ASPEN **AP** |  
 ESPRESSO **ESP** | CLASSIC CHERRY **CCY** | WALNUT **WAL** |

TRADITIONAL OFFICE

### 4053 Goose Neck Arm Chair

25" W X 29" D X 43" H

St. Yardage: 3.5



Freight Class: 250  
 Cubic Ft: 29  
 Ship Weight: 48

Grade	1	2	3	4	5	6	7	8	9	10	L	LL
Zone 1	1588	1685	1775	1826	1902	1931	2054	2130	2225	2406	2780	2934
Zone 2	1612	1710	1802	1853	1931	1960	2085	2162	2258	2442	2822	2978
Zone 3	1636	1736	1828	1881	1959	1989	2116	2194	2292	2478	2863	3022

- Tufted seat and back
- Goose neck arms
- Queen Anne style legs
- Seat: 18"W x 17.75"D x 19.5"H

OPTION	PRICE	CODE
Non-Tufted Option	N/C	NT
Upholstered Arm Caps	114.00	UA

QS

### 4054 Armeless Side Chair

25" W X 29" D X 43" H

St. Yardage: 3.5

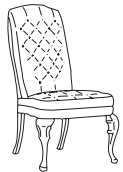

Freight Class: 250  
 Cubic Ft: 29  
 Ship Weight: 45

Grade	1	2	3	4	5	6	7	8	9	10	L	LL
Zone 1	1139	1189	1246	1320	1377	1453	1482	1605	1681	1776	1855	2285
Zone 2	1156	1207	1265	1340	1398	1475	1504	1629	1706	1803	1883	2319
Zone 3	1173	1225	1283	1360	1418	1497	1526	1653	1731	1829	1911	2354

- Tufted seat and back
- Queen Anne style legs
- Seat: 18"W x 17.75"D x 19.5"H

OPTION	PRICE	CODE
Non-Tufted Option	N/C	NT

QS

### 4057 Goose Neck Swivel

25" W X 29" D X 42-46" H

St. Yardage: 3.5



Freight Class: 250  
 Cubic Ft: 26  
 Ship Weight: 58

Grade	1	2	3	4	5	6	7	8	9	10	L	LL
Zone 1	1739	1836	1927	1977	2053	2082	2145	2205	2281	2376	2928	3185
Zone 2	1765	1864	1956	2007	2084	2113	2177	2238	2315	2412	2972	3233
Zone 3	1791	1891	1985	2036	2115	2144	2209	2271	2349	2447	3016	3281

- Tufted seat and back
- Goose neck arms
- 5-prong steel base with hardwood caps
- Pneumatic seat-height adjustment
- Standard swivel tilt
- Seat: 18"W x 17.75"D x 19-23"H

OPTION	PRICE	CODE
Knee Tilt Control	100.00	K
Non-Tufted Option		NT
Edge Guard	16.00	E
Upholstered Arm Caps	114.00	UA

CASTER OPTION	PRICE	CODE
Self-Locking Casters	85.00	S
Braking Casters	30.00	B
Hard-Floor Casters	19.00	H
Glides	N/C	GL

QS

### 4075 Arm Chair

28" W X 26" D X 32" H

St. Yardage: 3.5

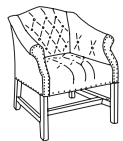

Freight Class: 250  
 Cubic Ft: 14  
 Ship Weight: 46

Grade	1	2	3	4	5	6	7	8	9	10	L	LL
Zone 1	1197	1305	1389	1435	1473	1511	1540	1663	1739	1834	2329	2543
Zone 2	1215	1325	1410	1457	1495	1534	1563	1688	1765	1862	2364	2581
Zone 3	1233	1344	1431	1478	1517	1556	1586	1713	1791	1889	2399	2619

- Tufted seat and back
- Brass nail head trim on arms and seat
- Chippendale style legs
- Cross rails for additional leg support
- Seat: 17"W x 18"D x 19.5"H

OPTION	PRICE	CODE
No Brass Trim Option	N/C	NB
Non-Tufted Option	N/C	NT

QS



# FINISH SELECTION

ROUGE MAHOGANY **RM** | WINDSOR CHERRY **WC** | BLACK **BLK** | MOAB **MOB** |  
 HONEY CHERRY **HCY** | PEARWOOD **PW** | MAHOGANY **MAH** | ASPEN **AP** | SIN VARIOUS  
 ESPRESSO **ESP** | CLASSIC CHERRY **CCY** | WALNUT **WAL** |

# TRADITIONAL SERIES

TRADITIONAL OFFICE

## 4076 Conference Chair with Casters

28" W X 26" D X 32" H

St. Yardage: 3.5



Freight Class: 250  
 Cubic Ft: 14  
 Ship Weight: 45

Grade	1	2	3	4	5	6	7	8	9	10	L	LL
Zone 1	1229	1328	1420	1467	1543	1572	1695	1771	1866	2047	2437	2675
Zone 2	1247	1348	1441	1489	1566	1596	1720	1798	1894	2078	2474	2715
Zone 3	1266	1368	1463	1511	1589	1619	1746	1824	1922	2108	2510	2755

- Tufted seat and back
- Brass nail head trim on arms and seat
- Chippendale style base
- Dual wheel casters
- Available in the finishes listed
- Seat: 17"W x 18"D x 19.5"H

OPTION	PRICE	CODE
No Brass Trim Option	N/C	NB
Non-Tufted Option	N/C	NT

**QS**

## 4072 Loveseat

57" W X 27.5" D X 34" H

St. Yardage: 6



Freight Class: 175  
 Cubic Ft: 36  
 Ship Weight: 78

Grade	1	2	3	4	5	6	7	8	9	10	L	LL
Zone 1	1756	1954	2122	2215	2361	2418	2655	2802	2985	3333	4049	4259
Zone 2	1782	1983	2154	2248	2396	2454	2695	2844	3030	3383	4110	4323
Zone 3	1809	2013	2186	2281	2432	2491	2735	2886	3075	3433	4170	4387

- Tufted seat, back and inside arm
- Brass nail head trim on arms and seat
- Chippendale style legs
- Traditional scroll arm and camelback
- Cross rail adds leg support
- Seat: 47.5"W x 17.5"D x 19"H

OPTION	PRICE	CODE
No Brass Trim Option	N/C	NB
Non-Tufted Option	N/C	NT

**QS**

## 4083 Sofa

78" W X 28" D X 35" H

St. Yardage: 8



Freight Class: 175  
 Cubic Ft: 54  
 Ship Weight: 113

Grade	1	2	3	4	5	6	7	8	9	10	L	LL
Zone 1	2173	2420	2632	2750	2935	3007	3305	3490	3721	4159	4969	5199
Zone 2	2206	2456	2671	2791	2979	3052	3355	3542	3777	4221	5044	5277
Zone 3	2238	2493	2711	2833	3023	3097	3404	3595	3833	4284	5118	5355

- Tufted seat, back and inside arm
- Brass nail head trim on arms and seat
- Chippendale style legs
- Traditional scroll arm and camelback
- Cross rail adds leg support
- Seat: 66"W x 18"D x 19"H

OPTION	PRICE	CODE
No Brass Trim Option	N/C	NB
Non-Tufted Option	N/C	NT

**QS**

## TR\_4020 Traditional Cocktail Table



Freight Class: 100

- High-gloss, high pressure laminate top in Mahogany and Windsor Cherry
- Shaped edges
- Ships unassembled, easy assembly

		Zone Pricing		
		1	2	3
54" X 24" X 16"	Cubic Ft: 5.5 Ship Weight: 69.5	<b>748</b>	<b>759</b>	<b>770</b>

Finish Options: Mahogany (M), Windsor Cherry (WC) and Oak (O)  
 Note: Oak finish has a satin laminate top

SIN 711-11

**QS**

## TR\_4023 Traditional End Table

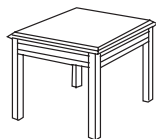

Freight Class: 92.5

- High-gloss, high pressure laminate top in Mahogany and Windsor Cherry
- Shaped edges
- Ships unassembled, easy assembly

22" X 27" X 18"	Cubic Ft: 2.5 Ship Weight: 38	<b>618</b>	<b>627</b>	<b>637</b>
-----------------	-------------------------------	------------	------------	------------

Finish Options: Mahogany (M), Windsor Cherry (WC) and Oak (O)  
 Note: Oak finish has a satin laminate top

SIN 711-11

**QS**

# TRADITIONAL SERIES

## FINISH SELECTION

ROUGE MAHOGANY **RM** | WINDSOR CHERRY **WC** | BLACK **BLK** | MOAB **MOB** |  
 HONEY CHERRY **HCY** | PEARWOOD **PW** | MAHOGANY **MAH** | ASPEN **AP** |  
 ESPRESSO **ESP** | CLASSIC CHERRY **CCY** | WALNUT **WAL** |

TRADITIONAL OFFICE

### 4073 Wing Back Arm Chair

27" W X 29" D X 39" H

St. Yardage: 4



Freight Class: 250  
 Cubic Ft: 20  
 Ship Weight: 48

QS

Grade	1	2	3	4	5	6	7	8	9	10	L	LL
Zone 1	1242	1370	1485	1539	1633	1758	1806	2008	2133	2289	2506	3089
Zone 2	1261	1391	1507	1562	1657	1784	1833	2038	2165	2323	2544	3135
Zone 3	1279	1411	1530	1585	1682	1811	1860	2068	2197	2358	2581	3182

- Tufted seat and back
- Brass nail head trim on arms and seat
- Queen Anne style legs on front
- Seat: 19.5"F-16"B W x 18.25"D x 18.5"H

OPTION	PRICE	CODE
No Brass Trim Option	N/C	NB
Non-Tufted Option	N/C	NT

### 4074 Wing Back Arm Chair

29" W X 31" D X 40.5" H

St. Yardage: 4.5



Freight Class: 250  
 Cubic Ft: 26  
 Ship Weight: 51

QS

Grade	1	2	3	4	5	6	7	8	9	10	L	LL
Zone 1	1316	1412	1512	1665	1775	1911	1978	2215	2362	2545	2659	3319
Zone 2	1336	1433	1535	1690	1802	1940	2008	2248	2397	2583	2699	3369
Zone 3	1355	1454	1557	1715	1828	1968	2037	2281	2433	2621	2739	3419

- Queen Anne style legs on front
- Tufted seat and back
- Brass nail head trim on arms
- Full-size seat and back
- Seat: 18"B-22.5"F W x 19"D x 18.5"H

OPTION	PRICE	CODE
No Brass Trim Option	N/C	NB
Non-Tufted Option	N/C	NT

### 4077 Wing Back Swivel

25" W X 29" D X 42-46" H

St. Yardage: 4



Freight Class: 150  
 Cubic Ft: 26  
 Ship Weight: 71

QS

Grade	1	2	3	4	5	6	7	8	9	10	L	LL
Zone 1	1309	1437	1548	1615	1713	1750	1826	1908	2006	2128	2839	3011
Zone 2	1329	1459	1571	1639	1739	1776	1853	1937	2036	2160	2882	3056
Zone 3	1348	1480	1594	1663	1764	1803	1881	1965	2066	2192	2924	3101

- Tufted seat and back
- Brass nail head trim on arms and seat
- 5-prong steel base with hardwood caps
- Standard swivel tilt
- Pneumatic seat-height adjustment
- Dual wheel casters
- Seat: 19.5"F-16"B W x 18.25"D x 18-21"H

OPTION	PRICE	CODE
Knee Tilt Control	100.00	K
No Brass Trim Option	N/C	NB
Non-Tufted Option	N/C	NT
Edge Guard	16.00	E
CASTER OPTION	PRICE	CODE
Self-Locking Casters	85.00	S
Braking Casters	30.00	B
Hard-Floor Casters	19.00	H
Glides	N/C	GL

### 4078 Wing Back Executive Swivel

29" W X 30" D X 41-45" H

St. Yardage: 4.5



Freight Class: 150  
 Cubic Ft: 26  
 Ship Weight: 77

QS

Grade	1	2	3	4	5	6	7	8	9	10	L	LL
Zone 1	1582	1743	1888	1973	2098	2146	2348	2473	2629	2926	3329	3532
Zone 2	1606	1769	1916	2003	2129	2178	2383	2510	2668	2970	3379	3585
Zone 3	1629	1795	1945	2032	2161	2210	2418	2547	2708	3014	3429	3638

- Tufted seat and back
- Brass nail head trim on arms and seat
- 5-prong steel base with hardwood caps
- Standard swivel tilt
- Pneumatic seat-height adjustment
- Black dual-wheel carpet casters
- Seat: 18"B-22.5"F W x 19"D x 19-22.5"H

OPTION	PRICE	CODE
Knee Tilt Control	100.00	K
No Brass Trim Option	N/C	NB
Non-Tufted Option	N/C	NT
Edge Guard	16.00	E
CASTER OPTION	PRICE	CODE
Self-Locking Casters	85.00	S
Braking Casters	30.00	B
Hard-Floor Casters	19.00	H
Glides	N/C	GL

**FINISH SELECTION**

ROUGE MAHOGANY **RM** | WINDSOR CHERRY **WC** | BLACK **BLK** | MOAB **MOB** |  
 HONEY CHERRY **HCY** | PEARWOOD **PW** | MAHOGANY **MAH** | ASPEN **AP** | SIN VARIOUS  
 ESPRESSO **ESP** | CLASSIC CHERRY **CCY** | WALNUT **WAL** |

**TRADITIONAL SERIES**

TRADITIONAL OFFICE

**4178 Judge's Executive Swivel**

29" W X 32" D X 42-46" H

St. Yardage: 4.75



Grade	1	2	3	4	5	6	7	8	9	10	L	LL
<b>Zone 1</b>	1678	1848	2000	2069	2194	2242	2444	2569	2725	3022	3422	3721
<b>Zone 2</b>	1703	1876	2030	2100	2227	2276	2481	2608	2766	3067	3473	3777
<b>Zone 3</b>	1728	1903	2060	2131	2260	2309	2517	2646	2807	3113	3525	3833

- 5-prong steel base with hardwood caps
- Pneumatic seat-height adjustment
- Standard swivel tilt

- Brass nail trim on arms and seat
- Black dual-wheel carpet casters
- Seat: 18.5"B-23"F W x 19.75"D x 19-23"H

OPTION	PRICE	CODE
Knee Tilt Control	100.00	K
No Brass Trim Option	N/C	NB
Edge Guard	16.00	E

CASTER OPTION	PRICE	CODE
Self-Locking Casters	85.00	S
Braking Casters	30.00	B
Hard-Floor Casters	19.00	H
Glides	N/C	GL

Freight Class: 150

Cubic Ft: 28

Ship Weight: 79

**QS**

**4277 Extra-High Back Executive Swivel**

28" W X 31" D X 48-52" H

St. Yardage: 4.5



Grade	1	2	3	4	5	6	7	8	9	10	L	LL
<b>Zone 1</b>	1614	1762	1894	1954	2062	2104	2280	2388	2524	2782	2994	3380
<b>Zone 2</b>	1638	1788	1922	1983	2093	2136	2314	2424	2562	2824	3039	3431
<b>Zone 3</b>	1662	1815	1951	2013	2124	2167	2348	2460	2600	2865	3084	3481

- Tufted seat and back
- Thickly padded foam seat
- Brass nail head trim on arms and seat
- 5-prong steel base with hardwood caps
- Pneumatic seat-height adjustment
- Black dual-wheel carpet casters
- Seat: 18"W x 18"D x 19.5-23.5"H

OPTION	PRICE	CODE
Knee Tilt Control	100.00	K
No Brass Trim Option	N/C	NB
Non-Tufted Option	N/C	NT
Edge Guard	16.00	E

CASTER OPTION	PRICE	CODE
Self-Locking Casters	85.00	S
Braking Casters	30.00	B
Hard-Floor Casters	19.00	H
Glides	N/C	GL

Freight Class: 150

Cubic Ft: 27

Ship Weight: 83

**QS**

# SCOOP TRADITIONAL SIN 711-18

## FINISH SELECTION

ROUGE MAHOGANY **RM** | WINDSOR CHERRY **WC** | BLACK **BLK** | MOAB **MOB** |  
 HONEY CHERRY **HCY** | PEARWOOD **PW** | MAHOGANY **MAH** | ASPEN **AP** |  
 ESPRESSO **ESP** | CLASSIC CHERRY **CCY** | WALNUT **WAL** |

TRADITIONAL OFFICE

### Period Influence, Timeless Appeal

**Scoop Traditional Seating** features period influences in a variety of swivel and guest seating. Traditional tufting, individually placed brass nail trim and shaped wood base caps enhance the design.

### Scoop Traditional Details

- Pneumatic lifts on all swivel chairs
- Standard swivel tilt on all swivel chairs
- Brass nail trim
- 3 arm styles: open wood arms, platform arms with padded cap, and rolled style upholstered arm
- Dual-wheel casters

### Additional Options

- Knee tilt control option
- Edge Guard option
- Non-Tufted seat and back option
- No Brass Trim option



Executive 4161



Executive 4141



4121 Executive



4127 Management



4122 Guest



4123 Guest

## Scoop Traditional

### 4121 Executive Swivel

24" W X 31" D X 38-41.5" H

St. Yardage: 3.5



QS

Freight Class: 150

Cubic Ft: 21

Ship Weight: 51

Grade	1	2	3	4	5	6	7	8	9	10	L	LL
Zone 1	1082	1189	1280	1337	1418	1450	1581	1663	1765	1958	2363	2517
Zone 2	1098	1207	1299	1357	1439	1472	1605	1688	1791	1987	2398	2555
Zone 3	1114	1225	1318	1377	1461	1494	1628	1713	1818	2017	2434	2593

- Tufted seat and back
- Padded arms
- 5-prong steel base with hardwood caps
- Standard swivel tilt
- Pneumatic seat-height adjustment
- Dual wheel casters
- Seat: 19.75"W x 19"D x 18-21.5"H

OPTION	PRICE	CODE
Knee Tilt Control	100.00	K
Non-Tufted Option	N/C	NT
Edge Guard	16.00	E

CASTER OPTION	PRICE	CODE
Self-Locking Casters	85.00	S
Braking Casters	30.00	B
Hard-Floor Casters	19.00	H
Glides	N/C	GL

### 4122 Arm Chair

23" W X 27" D X 33" H

St. Yardage: 3.25



Freight Class: 250

Cubic Ft: 15

Ship Weight: 30

QS

Grade	1	2	3	4	5	6	7	8	9	10	L	LL
Zone 1	709	813	911	964	1045	1077	1208	1290	1392	1585	1982	2144
Zone 2	720	825	925	978	1061	1093	1226	1309	1413	1609	2012	2176
Zone 3	730	837	938	993	1076	1109	1244	1329	1434	1633	2041	2208

- Wood arms
- Tufted seat and back
- Built-in lumbar support
- Seat: 19.75"W x 19"D x 19.25"H

OPTION	PRICE	CODE
Non-Tufted Option	N/C	NT

**FINISH SELECTION**

ROUGE MAHOGANY **RM** | WINDSOR CHERRY **WC** | BLACK **BLK** | MOAB **MOB** |  
 HONEY CHERRY **HCY** | PEARWOOD **PW** | MAHOGANY **MAH** | ASPEN **AP** | SIN 711-18  
 ESPRESSO **ESP** | CLASSIC CHERRY **CCY** | WALNUT **WAL** |

# SCOOP TRADITIONAL

TRADITIONAL OFFICE

**4123 Arm Chair**

24" W X 32.7" D X 33" H

St. Yardage: 3.25



Freight Class: 250  
 Cubic Ft: 15  
 Ship Weight: 30

Grade	1	2	3	4	5	6	7	8	9	10	L	LL
<b>Zone 1</b>	<b>739</b>	<b>849</b>	<b>942</b>	<b>994</b>	<b>1075</b>	<b>1107</b>	<b>1238</b>	<b>1320</b>	<b>1422</b>	<b>1615</b>	<b>2011</b>	<b>2274</b>
<b>Zone 2</b>	<b>750</b>	<b>862</b>	<b>956</b>	<b>1009</b>	<b>1091</b>	<b>1124</b>	<b>1257</b>	<b>1340</b>	<b>1443</b>	<b>1639</b>	<b>2041</b>	<b>2308</b>
<b>Zone 3</b>	<b>761</b>	<b>874</b>	<b>970</b>	<b>1024</b>	<b>1107</b>	<b>1140</b>	<b>1275</b>	<b>1360</b>	<b>1465</b>	<b>1663</b>	<b>2071</b>	<b>2342</b>

	OPTION	PRICE	CODE
• Padded arms			
• Tufted seat and back	Non-Tufted Option	N/C	NT
• Built-in lumbar support			
• Seat: 19.75"W x 19"D x 19.25"H			

**QS**

**4127 Management Swivel**

24" W X 27.5" D X 32-35" H

St. Yardage: 3.25



Freight Class: 150  
 Cubic Ft: 19  
 Ship Weight: 48

Grade	1	2	3	4	5	6	7	8	9	10	L	LL
<b>Zone 1</b>	<b>1013</b>	<b>1118</b>	<b>1213</b>	<b>1268</b>	<b>1349</b>	<b>1381</b>	<b>1512</b>	<b>1594</b>	<b>1696</b>	<b>1889</b>	<b>2289</b>	<b>2448</b>
<b>Zone 2</b>	<b>1028</b>	<b>1135</b>	<b>1231</b>	<b>1287</b>	<b>1369</b>	<b>1402</b>	<b>1535</b>	<b>1618</b>	<b>1721</b>	<b>1917</b>	<b>2323</b>	<b>2485</b>
<b>Zone 3</b>	<b>1043</b>	<b>1152</b>	<b>1249</b>	<b>1306</b>	<b>1389</b>	<b>1422</b>	<b>1557</b>	<b>1642</b>	<b>1747</b>	<b>1946</b>	<b>2358</b>	<b>2521</b>

	OPTION	PRICE	CODE
• Tufted seat and back			
• Padded arms			
• 5-prong steel base with hardwood caps			
• Standard swivel tilt			
• Pneumatic seat-height adjustment	Knee Tilt Control	100.00	K
• Dual wheel casters	Jury Base	315.00	JB
• Seat: 19.75"W x 19"D x 18-21.5"H	Non-Tufted Option	N/C	NT
	Edge Guard	16.00	E
	CASTER OPTION	PRICE	CODE
	Self-Locking Casters	85.00	S
	Braking Casters	30.00	B
	Hard-Floor Casters	19.00	H
	Glides	N/C	GL

**QS**

**4141 Executive Swivel**

27" W X 31" D X 38-41.5" H

St. Yardage: 4.25



Freight Class: 150  
 Cubic Ft: 21  
 Ship Weight: 62

Grade	1	2	3	4	5	6	7	8	9	10	L	LL
<b>Zone 1</b>	<b>1210</b>	<b>1361</b>	<b>1488</b>	<b>1550</b>	<b>1658</b>	<b>1700</b>	<b>1788</b>	<b>1876</b>	<b>1984</b>	<b>2120</b>	<b>2578</b>	<b>2985</b>
<b>Zone 2</b>	<b>1228</b>	<b>1381</b>	<b>1510</b>	<b>1573</b>	<b>1683</b>	<b>1726</b>	<b>1815</b>	<b>1904</b>	<b>2014</b>	<b>2152</b>	<b>2617</b>	<b>3030</b>
<b>Zone 3</b>	<b>1246</b>	<b>1402</b>	<b>1533</b>	<b>1597</b>	<b>1708</b>	<b>1751</b>	<b>1842</b>	<b>1932</b>	<b>2044</b>	<b>2184</b>	<b>2655</b>	<b>3075</b>

	OPTION	PRICE	CODE
• Tufted seat and back			
• Fully upholstered, flared arms			
• 5-prong steel base with hardwood caps			
• Standard swivel tilt			
• Pneumatic seat-height adjustment	Knee Tilt Control	100.00	K
• Dual wheel casters	Non-Tufted Option	N/C	NT
• Seat: 19.5 "W x 19"D x 18-21.5"H	Edge Guard	16.00	E
	CASTER OPTION	PRICE	CODE
	Self-Locking Casters	85.00	S
	Braking Casters	30.00	B
	Hard-Floor Casters	19.00	H
	Glides	N/C	GL

**QS**

# SCOOP TRADITIONAL SIN 711-18

## FINISH SELECTION

ROUGE MAHOGANY **RM** | WINDSOR CHERRY **WC** | BLACK **BLK** | MOAB **MOB** |  
 HONEY CHERRY **HCY** | PEARWOOD **PW** | MAHOGANY **MAH** | ASPEN **AP** |  
 ESPRESSO **ESP** | CLASSIC CHERRY **CCY** | WALNUT **WAL** |

TRADITIONAL OFFICE

### 4147 Management Swivel

26" W X 27.5" D X 32-35" H

St. Yardage: 4



Grade	1	2	3	4	5	6	7	8	9	10	L	LL
Zone 1	1096	1245	1376	1436	1544	1586	1762	1870	2006	2264	2867	3076
Zone 2	1112	1264	1397	1458	1567	1610	1788	1898	2036	2298	2910	3122
Zone 3	1129	1282	1417	1479	1590	1634	1815	1926	2066	2332	2953	3168

Freight Class: 150

Cubic Ft: 19

Ship Weight: 50

**QS**

	OPTION	PRICE	CODE
<ul style="list-style-type: none"> <li>Tufted seat and back</li> <li>Fully upholstered, flared arms</li> <li>5-prong steel base with hardwood caps</li> <li>Standard swivel tilt</li> </ul>	Pneumatic seat-height adjustment		
	Dual wheel casters		
	Seat: 19.5 "W x 19"D x 18-21.5"H		
	Knee Tilt Control	100.00	K
	Jury Base	315.00	JB
	Non-Tufted Option	N/C	NT
	Edge Guard	16.00	E
CASTER OPTION		PRICE	CODE
	Self-Locking Casters	85.00	S
	Braking Casters	30.00	B
	Hard-Floor Casters	19.00	H
	Glides	N/C	GL

### 4161 Executive Swivel

25.5" W X 31" D X 38.5-42" H

St. Yardage: 3.5

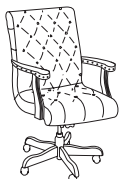

Grade	1	2	3	4	5	6	7	8	9	10	L	LL
Zone 1	1089	1199	1288	1344	1425	1457	1588	1670	1772	1965	2370	2524
Zone 2	1105	1217	1307	1364	1446	1479	1612	1695	1799	1994	2406	2562
Zone 3	1122	1235	1327	1384	1468	1501	1636	1720	1825	2024	2441	2600

Freight Class: 150

Cubic Ft: 21

Ship Weight: 53

**QS**

	OPTION	PRICE	CODE
<ul style="list-style-type: none"> <li>Tufted seat and back</li> <li>Padded platform arms</li> <li>5-prong steel base with hardwood caps</li> <li>Standard swivel tilt</li> </ul>	Pneumatic seat-height adjustment		
	Dual wheel casters		
	Seat: 19.5 "W x 19"D x 18-21.5"H		
	Knee Tilt Control	100.00	K
	No Brass Trim Option	N/C	NB
	Non-Tufted Option	N/C	NT
	Edge Guard	16.00	E
CASTER OPTION		PRICE	CODE
	Self-Locking Casters	85.00	S
	Braking Casters	30.00	B
	Hard-Floor Casters	19.00	H
	Glides	N/C	GL

### 4167 Management Swivel

25.5" W X 27.5" D X 32-35" H

St. Yardage: 3.25



Grade	1	2	3	4	5	6	7	8	9	10	L	LL
Zone 1	1034	1140	1233	1289	1370	1402	1533	1615	1717	1910	2313	2469
Zone 2	1050	1157	1251	1308	1391	1423	1556	1639	1743	1939	2348	2506
Zone 3	1065	1174	1270	1328	1411	1444	1579	1663	1769	1967	2382	2543

Freight Class: 150

Cubic Ft: 19

Ship Weight: 48

**QS**

	OPTION	PRICE	CODE
<ul style="list-style-type: none"> <li>Tufted seat and back</li> <li>Padded platform arms</li> <li>5-prong steel base with hardwood caps</li> <li>Standard swivel tilt</li> </ul>	Pneumatic seat-height adjustment		
	Dual wheel casters		
	Seat: 19.5 "W x 19"D x 18-21.5"H		
	Knee Tilt Control	100.00	K
	Jury Base	315.00	JB
	No Brass Trim Option	N/C	NB
	Non-Tufted Option	N/C	NT
	Edge Guard	16.00	E
CASTER OPTION		PRICE	CODE
	Self-Locking Casters	85.00	S
	Braking Casters	30.00	B
	Hard-Floor Casters	19.00	H
	Glides	N/C	GL



**FINISH SELECTION**

ROUGE MAHOGANY **RM** | WALNUT **WAL** |  
 WINDSOR CHERRY **WC** | BLACK **BLK** | ESPRESSO **ESP** |  
 HONEY CHERRY **HCY** | PEARWOOD **PW** | ASPEN **AP** |  
 MAHOGANY **MAH** | CLASSIC CHERRY **CCY** | MOAB **MOB**

SIN 711-18

# QUICK SILVER TRADITIONAL

TRADITIONAL OFFICE

## Quick Silver Traditional

### 4831 Executive Swivel

25" W X 28" D X 40-44" H

St. Yardage: 3



Freight Class: 150

Cubic Ft: 23

Ship Weight: 55

**QS**

Grade	1	2	3	4	5	6	7	8	9	10	L	LL
<b>Zone 1</b>	1070	1164	1247	1291	1361	1389	1503	1573	1662	1830	2214	2427
<b>Zone 2</b>	1086	1181	1266	1310	1381	1410	1526	1597	1687	1857	2247	2463
<b>Zone 3</b>	1102	1199	1284	1330	1402	1431	1548	1620	1712	1885	2280	2500

- Brass nail head trim on arms
- 5-prong steel base with hardwood caps
- Standard swivel tilt, tufted back
- Pneumatic seat-height adjustment
- Seat: 19.25"W x 18"D x 17.5 -21.5"H

OPTION	PRICE	CODE
Knee Tilt Control	100.00	K
No Brass Trim Option	N/C	NB
Non-Tufted Option	N/C	NT
Edge Guard	16.00	E
CASTER OPTION	PRICE	CODE
Self-Locking Casters	85.00	S
Braking Casters	30.00	B
Hard-Floor Casters	19.00	H
Glides	N/C	GL

### 4837 Management Swivel

25" W X 26" D X 32-36" H

St. Yardage: 2.5



Freight Class: 150

Cubic Ft: 19

Ship Weight: 51

**QS**

Grade	1	2	3	4	5	6	7	8	9	10	L	LL
<b>Zone 1</b>	1025	1100	1162	1195	1249	1270	1358	1412	1480	1609	1903	2115
<b>Zone 2</b>	1040	1117	1179	1213	1268	1289	1378	1433	1502	1633	1932	2147
<b>Zone 3</b>	1056	1133	1197	1231	1286	1308	1399	1454	1524	1657	1960	2178

- Brass nail head trim on arms
- 5-prong steel base with hardwood caps
- Standard swivel tilt, tufted back
- Pneumatic seat-height adjustment
- Dual wheel casters
- Seat: 19.25"W x 18"D x 17.5 -21.5"H

OPTION	PRICE	CODE
Knee Tilt Control	100.00	K
Jury Base	315.00	JB
No Brass Trim Option	N/C	NB
Non-Tufted Option	N/C	NT
Edge Guard	16.00	E
CASTER OPTION	PRICE	CODE
Self-Locking Casters	85.00	S
Braking Casters	30.00	B
Hard-Floor Casters	19.00	H
Glides	N/C	GL

### 4833 Side Chair

24" W X 26" D X 33" H

St. Yardage: 2.5



Freight Class: 150

Cubic Ft: 15

Ship Weight: 29

**QS**

Grade	1	2	3	4	5	6	7	8	9	10	L	LL
<b>Zone 1</b>	938	1014	1076	1118	1162	1183	1271	1325	1393	1522	1822	2028
<b>Zone 2</b>	952	1029	1092	1135	1179	1201	1290	1345	1414	1545	1849	2058
<b>Zone 3</b>	966	1044	1108	1152	1197	1218	1309	1365	1435	1568	1877	2089

- Wood arms
- Tufted back
- Seat: 19.25"W x 18"D x 18.5"H

OPTION	PRICE	CODE
Non-Tufted Option	N/C	NT

# VALUE TRADITIONAL SIN 711-18

## FINISH SELECTION

ROUGE MAHOGANY **RM** | WINDSOR CHERRY **WC** | BLACK **BLK** | MOAB **MOB** |  
 HONEY CHERRY **HCY** | PEARWOOD **PW** | MAHOGANY **MAH** | ASPEN **AP** |  
 ESPRESSO **ESP** | CLASSIC CHERRY **CCY** | WALNUT **WAL** |

TRADITIONAL OFFICE

### Traditional Values

**Value Traditional Seating** features period influences in a variety of swivel and guest seating. Traditional tufting, individually placed brass nail trim and shaped wood base caps enhance the design.



2277 Executive



2177 Executive



2016 Conference Chair



2013 Captain's Chair



3473 Guest

### Design Details

- Pneumatic seat/height adjustment on all swivel chairs
- Standard swivel tilt on all swivel chairs
- Brass nail trim
- Dual-wheel casters

### Additional Options

- Non-Tufted seat and back option
- No Brass Trim option

## Value Traditional

### 2013 Arm Chair

25" W X 23" D X 30.5" H

St. Yardage: 2



Grade	1	2	3	4	5	6	7	8	9	10	L	LL
Zone 1	601	656	705	737	780	797	867	911	965	1068	1265	1413
Zone 2	610	666	716	748	792	809	880	925	979	1084	1284	1434
Zone 3	619	676	726	759	803	821	893	938	994	1100	1303	1455

Freight Class: 250  
 Cubic Ft: 11  
 Ship Weight: 31

- Thickly padded foam seat
- Brass nail head trim on arms and seat
- Padded platform arms
- Seat: 20"W x 19"D x 19"H

OPTION	PRICE	CODE
No Brass Trim Option	N/C	NB

### QS

### 2016 Conference Chair

25.5" W X 23" D X 30.5" H

St. Yardage: 2

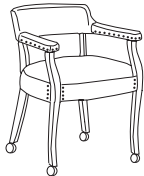

Grade	1	2	3	4	5	6	7	8	9	10	L	LL
Zone 1	659	718	768	795	838	855	925	969	1023	1126	1341	1471
Zone 2	669	729	780	807	851	868	939	984	1038	1143	1361	1493
Zone 3	679	740	791	819	863	881	953	998	1054	1160	1381	1515

Freight Class: 250  
 Cubic Ft: 11  
 Ship Weight: 31

- Thickly padded foam seat
- Brass nail head trim on arms and seat
- Padded platform arms
- 4 dual wheel carpet casters
- Seat: 20"W x 19"D x 18.5"H

OPTION	PRICE	CODE
No Brass Trim Option	N/C	NB

### QS

### 2177 Executive Swivel

27" W X 28.5" D X 40-43" H

St. Yardage: 3.5



Grade	1	2	3	4	5	6	7	8	9	10	L	LL
Zone 1	1077	1177	1267	1315	1391	1420	1543	1619	1714	1895	2311	2423
Zone 2	1093	1195	1286	1335	1412	1441	1566	1643	1740	1923	2346	2459
Zone 3	1109	1212	1305	1354	1433	1463	1589	1668	1765	1952	2380	2496

Freight Class: 150  
 Cubic Ft: 23  
 Ship Weight: 64

- Thickly padded foam seat
- Brass nail head trim on seat
- 5-prong steel base with hardwood caps
- Standard swivel tilt
- Pneumatic seat height adjustment
- Dual wheel casters
- Seat: 18.25"W x 19"D x 20-23"H

OPTION	PRICE	CODE
Knee Tilt Control	100.00	K
No Brass Trim Option	N/C	NB
Edge Guard	16.00	E

CASTER OPTION	PRICE	CODE
Self-Locking Casters	85.00	S
Braking Casters	30.00	B
Hard-Floor Casters	19.00	H
Glides	N/C	GL

### QS

# FINISH SELECTION

ROUGE MAHOGANY **RM** | WINDSOR CHERRY **WC** | BLACK **BLK** |  
 HONEY CHERRY **HCY** | PEARWOOD **PW** | MAHOGANY **MAH** | ASPEN **AP** |  
 ESPRESSO **ESP** | CLASSIC CHERRY **CCY** | WALNUT **WAL** | MOAB **MOB** |

SIN 711-18

# VALUE TRADITIONAL

TRADITIONAL OFFICE

## 2277 Executive Swivel

27" W X 28.5" D X 40-43" H

St. Yardage: 3.5



Grade	1	2	3	4	5	6	7	8	9	10	L	LL
Zone 1	1170	1269	1361	1408	1484	1513	1636	1712	1807	1988	2410	2616
Zone 2	1188	1288	1381	1429	1506	1536	1661	1738	1834	2018	2446	2655
Zone 3	1205	1307	1402	1450	1529	1558	1685	1763	1861	2048	2482	2694

- Thickly padded foam seat
- Tufted back
- Brass nail head trim on seat
- 5-prong steel base with hardwood caps
- Standard swivel tilt
- Pneumatic seat height adjustment
- Dual wheel casters
- Seat: 18.25"W x 19"D x 20-23"H

OPTION	PRICE	CODE
Knee Tilt Control	100.00	K
No Brass Trim Option	N/C	NB
Non-Tufted Option	N/C	NT
Edge Guard	16.00	E

CASTER OPTION	PRICE	CODE
Self-Locking Casters	85.00	S
Braking Casters	30.00	B
Hard-Floor Casters	19.00	H
Glides	N/C	GL

Freight Class: 150

Cubic Ft: 23

Ship Weight: 64

**QS**

## 3473 Martha Washington Chair

24" W X 27" D X 40" H

St. Yardage: 3



Grade	1	2	3	4	5	6	7	8	9	10	L	LL
Zone 1	950	1041	1121	1171	1241	1269	1383	1453	1542	1710	2049	2207
Zone 2	964	1057	1138	1189	1260	1288	1404	1475	1565	1736	2080	2240
Zone 3	979	1072	1155	1206	1278	1307	1424	1497	1588	1761	2110	2273

- Thickly padded foam seat
- Upholstered arms
- Seat: 18.75"W x 18.75"D x 20"H

OPTION	PRICE	CODE
Tufted Seat for Chair	50.00	TS
Tufted Back for Chair	50.00	TB
Tufted Seat/Back for Chair	100.00	TSB

Freight Class: 150

Cubic Ft: 20

Ship Weight: 38

**QS**

## 3477 Martha Washington Swivel

24" W X 27" D X 40-44" H

St. Yardage: 3



Grade	1	2	3	4	5	6	7	8	9	10	L	LL
Zone 1	1092	1186	1266	1313	1383	1411	1525	1595	1684	1852	2198	2349
Zone 2	1108	1204	1285	1333	1404	1432	1548	1619	1709	1880	2231	2384
Zone 3	1125	1222	1304	1352	1424	1453	1571	1643	1735	1908	2264	2419

- Thickly padded foam seat
- 5-prong steel base with hardwood caps
- Standard swivel tilt
- Upholstered arms
- Pneumatic seat-height adjustment
- Dual wheel casters
- Seat: 18.75"W x 18.75"D x 19.75-23"H

OPTION	PRICE	CODE
Knee Tilt Control	100.00	K
Edge Guard	16.00	E
Tufted Seat for Chair	50.00	TS
Tufted Back for Chair	50.00	TB
Tufted Seat/Back for Chair	100.00	TSB

CASTER OPTION	PRICE	CODE
Self-Locking Casters	85.00	S
Braking Casters	30.00	B
Hard-Floor Casters	19.00	H
Glides	N/C	GL

Freight Class: 150

Cubic Ft: 23

Ship Weight: 59

**QS**

CONTEMPORARY

### A Metropolitan Style

**Himalaya** reception, executive and guest seating present unique, contemporary solutions for every area of a commercial environment. From lobbies and lounges to conference rooms and private offices, Himalaya offers a consistent, metropolitan style in a design based on modern classics. All models available in full-relief, back-relief and solid (no-relief) versions.



**152 Loveseat showing standard style stitching (Full Relief) on seat and back**

### Himalaya Details

- Relief-upholstered seat/back
- Square pattern stitch design
- Double-needle tailoring
- Extra-thick, ultracell seat foam
- Wood finish legs

### Relief Stitching Order Information

- **Full Relief:** standard
- **Back Relief:** add **SB** to model number
- **Solid:** add **SN** to model number



### STANDARD ORDER: SPECIFICATION DETAIL

<b>151</b>	<b>SB</b>	<b>WC</b>	<b>100</b>	<b>SF</b>	<b>Please Note:</b> If a softer, high-density seat foam is desired, specify <b>SF</b> and add \$16 list per seat.
Base Model	OPTIONAL Stitching Relief	Leg Finish Selection	Fabric/Leather Selection	OPTIONAL High-Density Seat Foam	

**Please Note:** Full Relief stitching on seat and back is standard. If no stitching (Solid **SN**) or back-only stitching (Back Relief **SB**) is desired, please enter the appropriate model number.

## Himalaya

### 151 Club Chair

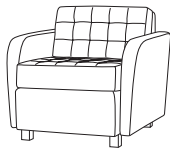

FREIGHT CLASS: 175  
 CUBIC FT: 29  
 SHIP WEIGHT: 81

**QS**

32" W X 31" D X 30" H      St. Yardage: 6.25      Seat & Back Ydg: 3.5      Arms Ydg: 3

Grade	1	2	3	4	5	6	7	8	9	10	L	LL
<b>Zone 1</b>	1748	1937	2110	2224	2376	2435	2680	2832	3022	3384	3916	4240
<b>Zone 2</b>	1774	1966	2142	2257	2412	2472	2720	2874	3067	3435	3975	4304
<b>Zone 3</b>	1800	1995	2173	2291	2447	2508	2760	2917	3113	3486	4033	4367

	OPTION	PRICE	CODE
• Relief-upholstered seat/back			
• Square pattern stitch design			
• Double-needle tailoring			
• Extra-thick, ultracell seat foam			
• Loose-appearance, fixed cushions			
• Wood finish legs			
• Seat: 24"W x 21.5"D x 18.5"H			
	Softer Seat Foam-Chair	16.00	SF

### 152 Loveseat

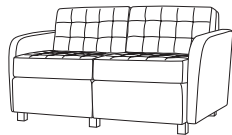

FREIGHT CLASS: 175  
 CUBIC FT: 42  
 SHIP WEIGHT: 117

**QS**

56.5" W X 31" D X 30" H      St. Yardage: 9.5      Seat & Back Ydg: 6.75      Arms Ydg: 3

Grade	1	2	3	4	5	6	7	8	9	10	L	LL
<b>Zone 1</b>	2533	2911	3254	3450	3744	3857	4331	4624	4991	5688	6860	7239
<b>Zone 2</b>	2571	2955	3303	3502	3800	3915	4396	4693	5066	5773	6963	7348
<b>Zone 3</b>	2609	2998	3352	3554	3856	3973	4461	4763	5141	5859	7066	7456

	OPTION	PRICE	CODE
• Relief-upholstered seat/back			
• Square pattern stitch design			
• Double-needle tailoring			
• Extra-thick, ultracell seat foam			
• Loose-appearance, fixed cushions			
• Wood finish legs			
• Seat: 49"W x 21.5"D x 18.5"H			
	Softer Seat Foam-Loveseat	32.00	SF

### 153 Sofa

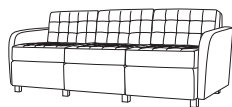

FREIGHT CLASS: 175  
 CUBIC FT: 55  
 SHIP WEIGHT: 157

**QS**

81" W X 31" D X 30" H      St. Yardage: 13      Seat & Back Ydg: 10.5      Arms Ydg: 3

Grade	1	2	3	4	5	6	7	8	9	10	L	LL
<b>Zone 1</b>	3224	3744	4219	4464	4861	5014	5654	6051	6547	7489	9185	9621
<b>Zone 2</b>	3272	3800	4282	4531	4934	5089	5739	6142	6645	7601	9323	9765
<b>Zone 3</b>	3321	3856	4346	4598	5007	5164	5824	6233	6743	7714	9461	9910

	OPTION	PRICE	CODE
• Relief-upholstered seat/back			
• Square pattern stitch design			
• Double-needle tailoring			
• Extra-thick, ultracell seat foam			
• Loose-appearance, fixed cushions			
• Wood finish legs			
• Seat: 73"W x 21.5"D x 18.5"H			
	Softer Seat Foam-Sofa	48.00	SF

## FINISH SELECTION

ASPEN **AP** | BLACK **BLK** | NATURAL **FM** | HONEY CHERRY **HCY** | ROUGE  
 MAHOGANY **RM** | MAHOGANY **MAH** | MOAB **MOB** | PEARWOOD **PW** | WALNUT  
 WAL | WINDSOR CHERRY **WC** | CLASSIC CHERRY **CCY** | ESPRESSO **ESP** |

SIN 711-17 **HIMALAYA**

CONTEMPORARY

### 154 Lounge Chair, Armless



FREIGHT CLASS: 175  
 CUBIC FT: 29  
 SHIP WEIGHT: 51

QS

25" W X 31" D X 30" H

St. Yardage: 4

Grade	1	2	3	4	5	6	7	8	9	10	L	LL
Zone 1	1533	1653	1761	1822	1914	1950	2099	2191	2307	2526	2880	3046
Zone 2	1556	1678	1787	1849	1943	1979	2130	2224	2342	2564	2923	3092
Zone 3	1579	1703	1814	1877	1971	2009	2162	2257	2376	2602	2966	3137

- Relief-upholstered seat/back
- Square pattern stitch design
- Double-needle tailoring
- Extra-thick, ultracell seat foam
- Loose-appearance, fixed cushions
- Wood finish legs
- Seat: 24.5"W x 21.5"D x 18.5"H

OPTION	PRICE	CODE
Softer Seat Foam-Chair	16.00	SF

### 155 Two-Seat Lounge, Armless

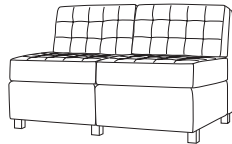

FREIGHT CLASS: 175  
 CUBIC FT: 42  
 SHIP WEIGHT: 90

QS

50" W X 31" D X 30" H

St. Yardage: 7

Grade	1	2	3	4	5	6	7	8	9	10	L	LL
Zone 1	2244	2502	2724	2821	3006	3078	3376	3561	3792	4230	5047	5270
Zone 2	2278	2540	2765	2863	3051	3124	3427	3614	3849	4293	5123	5349
Zone 3	2311	2577	2806	2906	3096	3170	3477	3668	3906	4357	5198	5428

- Relief-upholstered seat/back
- Square pattern stitch design
- Double-needle tailoring
- Extra-thick, ultracell seat foam
- Loose-appearance, fixed cushions
- Wood finish legs
- Seat: 49"W x 21.5"D x 18.5"H

OPTION	PRICE	CODE
Softer Seat Foam-Loveseat	32.00	SF

### 156 Three-Seat Lounge, Armless

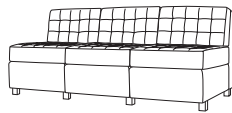

FREIGHT CLASS: 175  
 CUBIC FT: 54  
 SHIP WEIGHT: 128

QS

74" W X 31" D X 30" H

St. Yardage: 10.5

Grade	1	2	3	4	5	6	7	8	9	10	L	LL
Zone 1	2855	3242	3578	3721	3998	4105	4553	4830	5176	5835	7135	7394
Zone 2	2898	3291	3632	3777	4058	4167	4621	4902	5254	5923	7242	7505
Zone 3	2941	3339	3685	3833	4118	4228	4690	4975	5331	6010	7349	7616

- Relief-upholstered seat/back
- Square pattern stitch design
- Double-needle tailoring
- Extra-thick, ultracell seat foam
- Loose-appearance, fixed cushions
- Wood finish legs
- Seat: 73"W x 21.5"D x 18.5"H

OPTION	PRICE	CODE
Softer Seat Foam-Sofa	48.00	SF

### 157 4' Bench

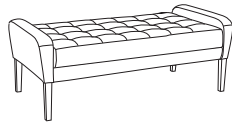

FREIGHT CLASS: 150  
 CUBIC FT: 13  
 SHIP WEIGHT: 43

QS

48" W X 18" D X 19.25" H

St. Yardage: 3

Grade	1	2	3	4	5	6	7	8	9	10	L	LL
Zone 1	1335	1377	1440	1516	1573	1639	1678	1801	1877	1972	2321	2581
Zone 2	1355	1398	1462	1539	1597	1664	1703	1828	1905	2002	2356	2620
Zone 3	1375	1418	1483	1561	1620	1688	1728	1855	1933	2031	2391	2658

- Relief-upholstered seat
- Square pattern stitch design
- Double-needle tailoring
- Extra-thick, high-density foam
- Solid wood legs
- Seat: 43"W x 17.5"D x 18"H

OPTION	PRICE	CODE
Softer Seat Foam-Loveseat	32.00	SF

### 158 6' Bench

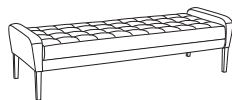

FREIGHT CLASS: 150  
 CUBIC FT: 25  
 SHIP WEIGHT: 75

QS

72" W X 24" D X 19.25" H

St. Yardage: 4

Grade	1	2	3	4	5	6	7	8	9	10	L	LL
Zone 1	1702	1757	1841	1937	2025	2118	2168	2334	2438	2567	3000	3393
Zone 2	1728	1783	1869	1966	2055	2150	2201	2369	2475	2606	3045	3444
Zone 3	1753	1810	1896	1995	2086	2182	2233	2404	2511	2644	3090	3495

- Relief-upholstered seat
- Square pattern stitch design
- Double-needle tailoring
- Extra-thick, high-density foam
- Solid wood legs
- Seat: 64"W x 23.5"D x 18"H

OPTION	PRICE	CODE
Softer Seat Foam-Sofa	48.00	SF

ALL FOAM & FABRICS USED ARE CAL 117 APPROVED

QS indicates a Quickship item if ordered in Quickship upholstery.  
 Quick Ship is not available on any item ordered with options.

# HIMALAYA SIN 711-17

## FINISH SELECTION

ASPEN **AP** | BLACK **BLK** | NATURAL **FM** | HONEY CHERRY **HCY** | ROUGE  
 MAHOGANY **RM** | MAHOGANY **MAH** | MOAB **MOB** | PEARWOOD **PW** | WALNUT  
**WAL** | WINDSOR CHERRY **WC** | CLASSIC CHERRY **CCY** | ESPRESSO **ESP** |

CONTEMPORARY

### 143 Arm Chair



FREIGHT CLASS: 300  
 CUBIC FT: 15  
 SHIP WEIGHT: 27

**QS**

22.75" W X 26" D X 33.5" H

St. Yardage: 1.75

Grade	1	2	3	4	5	6	7	8	9	10	L	LL
<b>Zone 1</b>	<b>951</b>	<b>1028</b>	<b>1095</b>	<b>1121</b>	<b>1175</b>	<b>1196</b>	<b>1284</b>	<b>1338</b>	<b>1406</b>	<b>1535</b>	<b>1779</b>	<b>1841</b>
<b>Zone 2</b>	<b>965</b>	<b>1043</b>	<b>1111</b>	<b>1138</b>	<b>1193</b>	<b>1214</b>	<b>1303</b>	<b>1358</b>	<b>1427</b>	<b>1558</b>	<b>1806</b>	<b>1869</b>
<b>Zone 3</b>	<b>980</b>	<b>1059</b>	<b>1128</b>	<b>1155</b>	<b>1210</b>	<b>1232</b>	<b>1323</b>	<b>1378</b>	<b>1448</b>	<b>1581</b>	<b>1832</b>	<b>1896</b>

- Exposed legs and arms are solid hardwood
- Square pattern stitching with hand pulled reliefs

- Specify wood finish
- Seat: 19"W x 18"D x 19"H

OPTION	PRICE	CODE
Softer Seat Foam-Chair	16.00	SF

### 144 Armless Side Chair



FREIGHT CLASS: 300  
 CUBIC FT: 15  
 SHIP WEIGHT: 25

**QS**

19.5" W X 26" D X 33.5" H

St. Yardage: 1.75

Grade	1	2	3	4	5	6	7	8	9	10	L	LL
<b>Zone 1</b>	<b>915</b>	<b>955</b>	<b>1055</b>	<b>1085</b>	<b>1139</b>	<b>1160</b>	<b>1248</b>	<b>1302</b>	<b>1370</b>	<b>1499</b>	<b>1721</b>	<b>1805</b>
<b>Zone 2</b>	<b>929</b>	<b>969</b>	<b>1071</b>	<b>1101</b>	<b>1156</b>	<b>1177</b>	<b>1267</b>	<b>1322</b>	<b>1391</b>	<b>1521</b>	<b>1747</b>	<b>1832</b>
<b>Zone 3</b>	<b>942</b>	<b>984</b>	<b>1087</b>	<b>1118</b>	<b>1173</b>	<b>1195</b>	<b>1285</b>	<b>1341</b>	<b>1411</b>	<b>1544</b>	<b>1773</b>	<b>1859</b>

- Exposed legs and arms are solid hardwood
- Square pattern stitching with hand pulled reliefs

- Specify wood finish
- Seat: 19"W x 18"D x 19"H

OPTION	PRICE	CODE
Softer Seat Foam-Chair	16.00	SF

**QS**

ALL FOAM & FABRICS USED ARE CAL 117 APPROVED  
 indicates a Quickship item if ordered in Quickship upholstery.  
 Quick Ship is not available on any item ordered with options.



## FINISH SELECTION

ASPEN **AP** | BLACK **BLK** | NATURAL **FM** | HONEY CHERRY **HCY** | ROUGE  
 MAHOGANY **RM** | MAHOGANY **MAH** | MOAB **MOB** | PEARWOOD **PW** | WALNUT  
 WAL | WINDSOR CHERRY **WC** | CLASSIC CHERRY **CCY** | ESPRESSO **ESP** |

SIN 711-17

# HIMALAYA METAL

CONTEMPORARY

### A Metropolitan Style with Metal Accents

**Himalaya Metal** reception, executive and guest seating present contemporary solutions for every area of an environment. From lobbies and lounges to conference rooms and private offices, Himalaya Metal offers a consistent, metropolitan style in a design based on modern classics. All models available in full-relief, back-relief and solid (no-relief) versions.



**154MET-SB Lounge Chair with Back Relief stitching**

### Himalaya Details

- Relief-upholstered seat/back
- Square pattern stitch design with double-stitch tailoring
- Extra-thick, ultracell seat foam
- Brushed aluminum finish legs

### Relief Stitching Order Information

- **Full Relief:** standard
- **Back Relief:** add **SB** to model number
- **Solid:** add **SN** to model number



### STANDARD ORDER: SPECIFICATION DETAIL

**154MET** **SB** **100** **SF**

Base Model      OPTIONAL      Fabric/Leather      OPTIONAL  
 Stitching Relief      Selection      High-Density Seat Foam

**Please Note:** If a softer, high-density seat foam is desired, specify **SF** and add \$16 list per seat.

**Please Note:** Full Relief stitching on seat and back is standard. If no stitching (Solid **SN**) or back-only stitching (Back Relief **SB**) is desired, please enter the appropriate model number.

## Himalaya Metal

### 151MET Club Chair

32" W X 31" D X 30" H      St. Yardage: 6.25

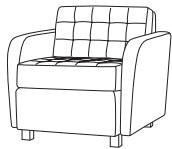

FREIGHT CLASS: 175  
 CUBIC FT: 29  
 SHIP WEIGHT: 87

**QS**

Grade	1	2	3	4	5	6	7	8	9	10	L	LL
Zone 1	1830	2020	2192	2306	2458	2517	2762	2914	3104	3466	3999	4322
Zone 2	1857	2050	2225	2341	2495	2555	2803	2958	3151	3518	4059	4387
Zone 3	1885	2081	2258	2375	2532	2593	2845	3001	3197	3570	4119	4452

- Relief-upholstered seat/back
- Square pattern stitch design
- Double-needle tailoring
- Extra-thick, ultracell seat foam
- Loose-appearance, fixed cushions
- Brushed aluminum finish legs with adjustable levelers
- Seat: 24"W x 21.5"D x 19.5"H

OPTION	PRICE	CODE
Softer Seat Foam-Chair	16.00	SF

### 152MET Loveseat

56.5" W X 31" D X 30" H      St. Yardage: 9.5

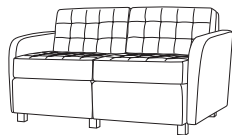

FREIGHT CLASS: 175  
 CUBIC FT: 42  
 SHIP WEIGHT: 128

**QS**

Grade	1	2	3	4	5	6	7	8	9	10	L	LL
Zone 1	2634	3012	3356	3551	3845	3958	4432	4725	5092	5789	6963	7440
Zone 2	2674	3057	3406	3604	3903	4017	4498	4796	5168	5876	7067	7552
Zone 3	2713	3102	3457	3658	3960	4077	4565	4867	5245	5963	7172	7663

- Relief-upholstered seat/back
- Square pattern stitch design
- Double-needle tailoring
- Extra-thick, ultracell seat foam
- Loose-appearance, fixed cushions
- Brushed aluminum finish legs with adjustable levelers
- Seat: 49"W x 21.5"D x 19.5"H

OPTION	PRICE	CODE
Softer Seat Foam-Loveseat	32.00	SF

### 153MET Sofa

81" W X 31" D X 30" H      St. Yardage: 13

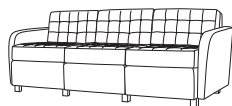

FREIGHT CLASS: 175  
 CUBIC FT: 54  
 SHIP WEIGHT: 161

**QS**

Grade	1	2	3	4	5	6	7	8	9	10	L	LL
Zone 1	3298	3811	4276	4538	4935	5188	5728	6125	6621	7563	9148	9795
Zone 2	3347	3868	4340	4606	5009	5266	5814	6217	6720	7676	9285	9942
Zone 3	3397	3925	4404	4674	5083	5344	5900	6309	6820	7790	9422	10089

- Relief-upholstered seat/back
- Square pattern stitch design
- Double-needle tailoring
- Extra-thick, ultracell seat foam
- Loose-appearance, fixed cushions
- Brushed aluminum finish legs with adjustable levelers
- Seat: 73"W x 21.5"D x 19.5"H

OPTION	PRICE	CODE
Softer Seat Foam-Sofa	48.00	SF

ALL FOAM & FABRICS USED ARE CAL 117 APPROVED

**QS** indicates a Quickship item if ordered in Quickship upholstery. Quick Ship is not available on any item ordered with options.

# HIMALAYA METAL

SIN 711-17

## FINISH SELECTION

ASPEN **AP** | BLACK **BLK** | NATURAL **FM** | HONEY CHERRY **HCY** | ROUGE  
 MAHOGANY **RM** | MAHOGANY **MAH** | MOAB **MOB** | PEARWOOD **PW** | WALNUT  
**WAL** | WINDSOR CHERRY **WC** | CLASSIC CHERRY **CCY** | ESPRESSO **ESP** |

CONTEMPORARY

### 154MET Lounge Chair, Armless

25" W X 31" D X 30" H

St. Yardage: 4

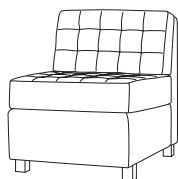

FREIGHT CLASS: 175  
 CUBIC FT: 29  
 SHIP WEIGHT: 55

QS

Grade	1	2	3	4	5	6	7	8	9	10	L	LL
Zone 1	1614	1736	1844	1903	1995	2031	2180	2272	2388	2607	2963	3127
Zone 2	1638	1762	1872	1932	2025	2061	2213	2306	2424	2646	3007	3174
Zone 3	1662	1788	1899	1960	2055	2092	2245	2340	2460	2685	3052	3221

	OPTION	PRICE	CODE
• Relief-upholstered seat/back	• Loose-appearance, fixed cushions		
• Square pattern stitch design	• Brushed aluminum finish legs with adjustable levelers	Softer Seat Foam-Chair	16.00 SF
• Double-needle tailoring	• Seat: 24"W x 21.5"D x 19.5"H		
• Extra-thick, ultracell seat foam			

### 155MET Two-Seat Lounge, Armless

50" W X 31" D X 30" H

St. Yardage: 7

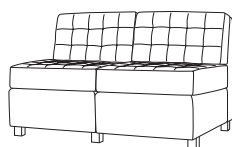

FREIGHT CLASS: 175  
 CUBIC FT: 42  
 SHIP WEIGHT: 97

QS

Grade	1	2	3	4	5	6	7	8	9	10	L	LL
Zone 1	2345	2604	2826	2905	3085	3154	3444	3623	3847	4273	5150	5382
Zone 2	2380	2643	2868	2949	3131	3201	3496	3677	3905	4337	5227	5463
Zone 3	2415	2682	2911	2992	3178	3249	3547	3732	3962	4401	5305	5543

	OPTION	PRICE	CODE
• Relief-upholstered seat/back	• Loose-appearance, fixed cushions		
• Square pattern stitch design	• Brushed aluminum finish legs with adjustable levelers	Softer Seat Foam-Loveseat	32.00 SF
• Double-needle tailoring	• Seat: 49"W x 21.5"D x 19.5"H		
• Extra-thick, ultracell seat foam			

### 156MET Three-Seat Lounge, Armless

74" W X 31" D X 30" H

St. Yardage: 10.5



FREIGHT CLASS: 175  
 CUBIC FT: 55  
 SHIP WEIGHT: 130

QS

Grade	1	2	3	4	5	6	7	8	9	10	L	LL
Zone 1	2937	3317	3647	3803	4080	4187	4635	4912	5258	5917	7137	7476
Zone 2	2981	3367	3702	3860	4141	4250	4705	4986	5337	6006	7244	7588
Zone 3	3025	3417	3756	3917	4202	4313	4774	5059	5416	6095	7351	7700

	OPTION	PRICE	CODE
• Relief-upholstered seat/back	• Loose-appearance, fixed cushions		
• Square pattern stitch design	• Brushed aluminum finish legs with adjustable levelers	Softer Seat Foam-Sofa	48.00 SF
• Double-needle tailoring	• Seat: 73"W x 21.5"D x 19.5"H		
• Extra-thick, ultracell seat foam			

**Sleek Lines, Comfortable Design**

The sleek lines of the **Eve Collection** take shape from the desire to provide a contemporary solution to reception areas, waiting rooms, open plan team areas, lobbies and training rooms. This extensive collection includes teaming, linear, curved seating and ganging brackets.



Eve configuration showing curved seating, bench and table models

**Eve Details**

- 5800s**– Armed and armless club chairs, loveseats and sofas
- 5830s & 5860s**– Linear and curved benches, loveseats and chairs. Create a unique configuration using the Eve ganging accessories.
- 5823**– Rectangular table, can be freestanding or connecting
- 5827s**– Teaming chairs with rotating tablet arm on left side facing standard.

**Additional Information**

- Eve includes 60° loveseats and benches plus 30° chairs, benches and wedge tables. Both 60° loveseats and 30° chairs are available with an inside or outside facing back.
- Eve's taut upholstery highlights this collection's contemporary look
- Brushed aluminum cylinder legs with adjustable glides



5801 Club Chair



5853 Armless Lounge

**Eve**

**5801 Club Chair with Arms**

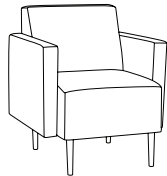

FREIGHT CLASS: 175  
CUBIC FT: 31  
SHIP WEIGHT: 79

**QS**

30" W X 31" D X 34" H

St. Yardage: 4.25

Grade	1	2	3	4	5	6	7	8	9	10	L	LL
Zone 1	1581	1624	1641	1710	1770	1830	1910	1989	2069	2148	2198	2248
Zone 2	1605	1648	1666	1736	1797	1857	1939	2019	2100	2180	2231	2282
Zone 3	1628	1673	1690	1761	1823	1885	1967	2049	2131	2212	2264	2315

- Sytex sheet webbing for long term support
- Fully upholstered seat/back/arms
- See other features above
- Seat: 25"W x 20"D x 19.5"H

**5802 Loveseat with Arms**



FREIGHT CLASS: 175  
CUBIC FT: 44  
SHIP WEIGHT: 92

**QS**

53" W X 31" D X 34" H

St. Yardage: 6.25

Grade	1	2	3	4	5	6	7	8	9	10	L	LL
Zone 1	2019	2106	2139	2209	2297	2385	2502	2619	2736	2854	2893	3000
Zone 2	2049	2138	2171	2242	2331	2421	2540	2658	2777	2897	2936	3045
Zone 3	2080	2169	2203	2275	2366	2457	2577	2698	2818	2940	2980	3090

- Sytex sheet webbing for long term support
- Fully upholstered seat/back/arms
- See other features above
- Seat: 45"W x 20"D x 19.5"H

**5803 Sofa with Arms**

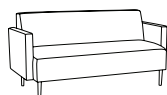

FREIGHT CLASS: 175  
CUBIC FT: 68  
SHIP WEIGHT: 112

**QS**

76" W X 31" D X 34" H

St. Yardage: 8

Grade	1	2	3	4	5	6	7	8	9	10	L	LL
Zone 1	2438	2568	2618	2682	2794	2907	3056	3356	3506	3694	3749	4050
Zone 2	2475	2607	2657	2722	2836	2951	3102	3406	3559	3749	3805	4111
Zone 3	2511	2645	2697	2762	2878	2994	3148	3457	3611	3805	3861	4172

- Sytex sheet webbing for long term support
- Fully upholstered seat/back/arms
- See other features above
- Seat: 68"W x 20"D x 19.5"H

**ALL FOAM & FABRICS USED ARE CAL 117 APPROVED**

**QS** indicates a Quickship item if ordered in Quickship upholstery. Quick Ship is not available on any item ordered with options.

### 5804 Armless Chair



FREIGHT CLASS: 175  
CUBIC FT: 28  
SHIP WEIGHT: 53

QS

25.5" W X 31" D X 34" H St. Yardage: 3

Grade	1	2	3	4	5	6	7	8	9	10	L	LL
Zone 1	1396	1439	1456	1487	1530	1572	1628	1684	1740	1797	1632	2000
Zone 2	1417	1461	1478	1509	1553	1596	1652	1709	1766	1824	1656	2030
Zone 3	1438	1482	1500	1532	1576	1619	1677	1735	1792	1851	1681	2060

- Sytex sheet webbing for long term support
- Fully upholstered seat/back
- See other features in series overview
- Seat: 25.5"W x 20"D x 19.5"H

### 5805 Armless Loveseat



FREIGHT CLASS: 175  
CUBIC FT: 67  
SHIP WEIGHT: 82

QS

45.5" W X 31" D X 34" H St. Yardage: 4.75

Grade	1	2	3	4	5	6	7	8	9	10	L	LL
Zone 1	1835	1922	1955	1980	2046	2113	2202	2291	2380	2469	2508	2581
Zone 2	1863	1951	1984	2010	2077	2145	2235	2325	2416	2506	2546	2620
Zone 3	1890	1980	2014	2039	2107	2176	2268	2360	2451	2543	2583	2658

- Sytex sheet webbing for long term support
- Fully upholstered seat/back
- See other features in series overview
- Seat: 45.5"W x 20"D x 19.5"H

### 5806 Armless Sofa



FREIGHT CLASS: 175  
CUBIC FT: 74  
SHIP WEIGHT: 102

QS

68" W X 31" D X 34" H St. Yardage: 7.25

Grade	1	2	3	4	5	6	7	8	9	10	L	LL
Zone 1	2254	2383	2433	2475	2577	2679	2814	2950	3086	3222	3264	3392
Zone 2	2288	2419	2469	2512	2616	2719	2856	2994	3132	3270	3313	3443
Zone 3	2322	2454	2506	2549	2654	2759	2898	3039	3179	3319	3362	3494

- Sytex sheet webbing for long term support
- Fully upholstered seat/back
- See other features in series overview
- Seat: 67.5"W x 20"D x 19.5"H

### 5830 30° Bench

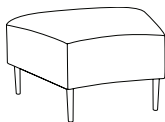

FREIGHT CLASS: 175  
CUBIC FT: 16  
SHIP WEIGHT: 40

QS

37.5" W X 29.5" D X 19.5" H St. Yardage: 2.75

Grade	1	2	3	4	5	6	7	8	9	10	L	LL
Zone 1	1370	1457	1489	1512	1531	1583	1634	1686	1737	1802	1843	2024
Zone 2	1391	1479	1511	1535	1554	1607	1659	1711	1763	1829	1871	2054
Zone 3	1411	1501	1534	1557	1577	1630	1683	1737	1789	1856	1898	2085

- Sytex sheet webbing for long term support
- Fully upholstered seat
- See other features in series overview
- Seat: 22.5-36.5"W x 27.5"D x 19.5"H

### 5860 60° Bench

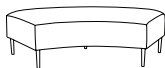

FREIGHT CLASS: 175  
CUBIC FT: 42  
SHIP WEIGHT: 71

QS

71" W X 33" D X 19.5" H St. Yardage: 3.75

Grade	1	2	3	4	5	6	7	8	9	10	L	LL
Zone 1	1894	2022	2074	2094	2145	2206	2267	2328	2404	2549	2605	2891
Zone 2	1922	2052	2105	2125	2177	2239	2301	2363	2440	2587	2644	2934
Zone 3	1951	2083	2136	2157	2209	2272	2335	2398	2476	2625	2683	2978

- Sytex sheet webbing for long term support
- Fully upholstered seat
- Use with other curved units to form curves, circles or serpentine shapes
- See other features in series overview
- Seat: 44-70"W x 27.5"D x 19.5"H

### 5831 One-Seat Bench

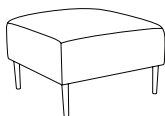

FREIGHT CLASS: 175  
CUBIC FT: 16  
SHIP WEIGHT: 30

QS

22.5" W X 28.5" D X 19.5" H St. Yardage: 1.75

Grade	1	2	3	4	5	6	7	8	9	10	L	LL
Zone 1	1265	1308	1325	1343	1367	1400	1433	1466	1499	1540	1502	1668
Zone 2	1284	1328	1345	1363	1388	1421	1454	1488	1521	1563	1525	1693
Zone 3	1303	1347	1365	1383	1408	1442	1476	1510	1544	1586	1547	1718

- Sytex sheet webbing for long term support
- Fully upholstered seat
- See other features in series overview
- Seat: 22"W x 28"D x 19.5"H

**5832 Two-Seat Bench**

45.5" W X 28.5" D X 19.5" H St. Yardage: 2.75

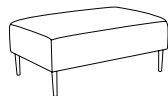

FREIGHT CLASS: 175  
CUBIC FT: 44  
SHIP WEIGHT: 50

**QS**

Grade	1	2	3	4	5	6	7	8	9	10	L	LL
Zone 1	1670	1757	1790	1831	1883	1934	1986	2037	2102	2224	2343	2514
Zone 2	1695	1783	1817	1858	1911	1963	2016	2068	2134	2257	2378	2552
Zone 3	1720	1810	1844	1886	1939	1992	2046	2098	2165	2291	2413	2589

- Sytex sheet webbing for long term support
- Fully upholstered seat
- See other features in series overview
- Seat: 45"W x 28"D x 19.5"H

**5833 Three-Seat Bench**

68" W X 28.5" D X 19.5" H St. Yardage: 4

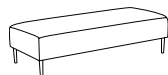

FREIGHT CLASS: 175  
CUBIC FT: 42  
SHIP WEIGHT: 70

**QS**

Grade	1	2	3	4	5	6	7	8	9	10	L	LL
Zone 1	2056	2185	2237	2256	2307	2368	2429	2490	2566	2711	2768	3053
Zone 2	2087	2218	2271	2290	2342	2404	2465	2527	2604	2752	2810	3099
Zone 3	2118	2251	2304	2324	2376	2439	2502	2565	2643	2792	2851	3145

- Sytex sheet webbing for long term support
- Fully upholstered seat
- See other features in series overview
- Seat: 67.5"W x 28"D x 19.5"H

**5865-OF 60° Loveseat (Outside Facing)**

71" W X 36.5" D X 34" H St. Yardage: 7



FREIGHT CLASS: 175  
CUBIC FT: 76  
SHIP WEIGHT: 122

**QS**

Grade	1	2	3	4	5	6	7	8	9	10	L	LL
Zone 1	2303	2390	2423	2475	2539	2648	2757	2902	3047	3193	3338	3519
Zone 2	2338	2426	2459	2512	2577	2688	2798	2946	3093	3241	3388	3572
Zone 3	2372	2462	2496	2549	2615	2727	2840	2989	3138	3289	3438	3625

- Sytex sheet webbing for long term support
- Fully upholstered seat/back
- See other features in series overview
- Seat: 53-70"W x 20"D x 19.5"H

**5865-IF 60° Loveseat (Inside Facing)**

74.5" W X 36.5" D X 34" H St. Yardage: 7.75

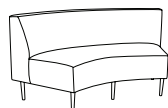

FREIGHT CLASS: 175  
CUBIC FT: 76  
SHIP WEIGHT: 135

**QS**

Grade	1	2	3	4	5	6	7	8	9	10	L	LL
Zone 1	2303	2390	2423	2475	2539	2648	2757	2902	3047	3193	3338	3519
Zone 2	2338	2426	2459	2512	2577	2688	2798	2946	3093	3241	3388	3572
Zone 3	2372	2462	2496	2549	2615	2727	2840	2989	3138	3289	3438	3625

- Sytex sheet webbing for long term support
- Fully upholstered seat/back
- Use with other curved units to form curves, circles or serpentine shapes
- See other features in series overview
- Seat: 44-63.5"W x 20"D x 19.5"H

**5835-OF 30° Chair (Outside Facing)**

37.5" W X 33" D X 34" H St. Yardage: 4

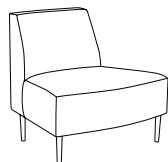

FREIGHT CLASS: 175  
CUBIC FT: 31  
SHIP WEIGHT: 61

**QS**

Grade	1	2	3	4	5	6	7	8	9	10	L	LL
Zone 1	1511	1554	1571	1597	1649	1700	1760	1800	1840	1919	2078	2178
Zone 2	1534	1577	1595	1621	1674	1726	1786	1827	1868	1948	2109	2211
Zone 3	1556	1601	1618	1645	1698	1751	1813	1854	1895	1977	2140	2243

- Sytex sheet webbing for long term support
- Fully upholstered seat/back
- See other features in series overview
- Seat: 23-32.5"W x 20"D x 19.5"H

**5835-IF 30° Chair (Inside Facing)**

39" W X 33" D X 34" H St. Yardage: 4.25



FREIGHT CLASS: 175  
CUBIC FT: 40  
SHIP WEIGHT: 66

**QS**

Grade	1	2	3	4	5	6	7	8	9	10	L	LL
Zone 1	1511	1554	1571	1597	1649	1700	1760	1800	1840	1919	2078	2178
Zone 2	1534	1577	1595	1621	1674	1726	1786	1827	1868	1948	2109	2211
Zone 3	1556	1601	1618	1645	1698	1751	1813	1854	1895	1977	2140	2243

- Sytex sheet webbing for long term support
- Fully upholstered seat/back
- See other features in series overview
- Seat: 23-32.5"W x 20"D x 19.5"H

**ALL FOAM & FABRICS USED ARE CAL 117 APPROVED**

**QS** indicates a Quickship item if ordered in Quickship upholstery. Quick Ship is not available on any item ordered with options.

### 5843 Armless Sofa/Bench with 2/3 Back-Right

68" W X 31" D X 34" H

St. Yardage: 6.5

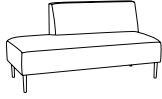

FREIGHT CLASS: 175  
CUBIC FT: 74  
SHIP WEIGHT: 98

**QS**

Grade	1	2	3	4	5	6	7	8	9	10	L	LL
Zone 1	2212	2312	2429	2524	2622	2753	2884	3016	3147	3311	3667	3960
Zone 2	2245	2347	2465	2562	2661	2794	2927	3061	3194	3361	3722	4019
Zone 3	2278	2381	2502	2600	2701	2836	2971	3106	3241	3410	3777	4079

- Stylish 2/3 back on right adds dimension
- Sytex sheet webbing for long term support
- Fully upholstered seat/back
- 3 optional arm styles available, must be factory installed
- Seat: 67.5" W x 20-28" D X 19.5" H

### 5844 Armless Sofa/Bench with 2/3 Back-Left

68" W X 31" D X 34" H

St. Yardage: 6.5

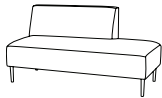

FREIGHT CLASS: 175  
CUBIC FT: 74  
SHIP WEIGHT: 98

**QS**

Grade	1	2	3	4	5	6	7	8	9	10	L	LL
Zone 1	2212	2312	2429	2524	2622	2753	2884	3016	3147	3311	3667	3960
Zone 2	2245	2347	2465	2562	2661	2794	2927	3061	3194	3361	3722	4019
Zone 3	2278	2381	2502	2600	2701	2836	2971	3106	3241	3410	3777	4079

- Stylish 2/3 back on left adds dimension
- Sytex sheet webbing for long term support
- Fully upholstered seat/back
- 3 optional arm styles available, must be factory installed
- Seat: 67.5" W x 20-28" D X 19.5" H

### 5853 Armless Lounge with Opposing Backs

68" W X 31" D X 34" H

St. Yardage: 7.25

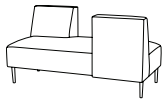

FREIGHT CLASS: 175  
CUBIC FT: 74  
SHIP WEIGHT: 100

**QS**

Grade	1	2	3	4	5	6	7	8	9	10	L	LL
Zone 1	2318	2425	2550	2652	2757	2898	3038	3179	3319	3495	3878	4220
Zone 2	2353	2461	2588	2692	2798	2941	3084	3227	3369	3547	3936	4283
Zone 3	2388	2498	2627	2732	2840	2985	3129	3274	3419	3600	3994	4347

- Opposing backs encourage face-to-face conversation
- Sytex sheet webbing for long term support
- Fully upholstered seat/back
- 3 optional arm styles available, must be factory installed
- Seat: 67.5" W x 20-28" D X 19.5" H

### 5836\_ 30° Connecting/Freestanding Wedge Table

37.5" W X 29.5" D X 16" H

St. Yardage: 1.5

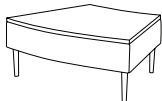

FREIGHT CLASS: 175  
CUBIC FT: 18  
SHIP WEIGHT: 72

**QS**

Grade	1	2	3	4	5	6	7	8	9	10	L	LL
Zone 1	1081	1124	1141	1153	1167	1197	1225	1253	1281	1316	1383	1541
Zone 2	1097	1141	1158	1170	1185	1215	1243	1272	1300	1336	1404	1564
Zone 3	1113	1158	1175	1188	1202	1233	1262	1291	1319	1355	1424	1587

- Thermally fused laminate top available in the finishes listed
- Taut-upholstered sides for a contemporary appearance
- See other features in series overview
- Quick Ship Finishes: Windsor Cherry, Natural Maple, Aspen, & Black

Finish Options: Natural Maple (FM), Windsor Cherry (WC), Mahogany (M), Graphite (GP), Medium Oak (O), Aspen (AP), Pearwood (PW), Black (E), Espresso (X), Grey (G), Classic Cherry (CC)

**Quick Ship Finishes:** Natural Maple (FM), Windsor Cherry (WC), Aspen (AP), & Black (E)

### 5823\_ Connecting/Freestanding Table

23" W X 27" D X 16" H

St. Yardage: 1

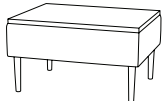

FREIGHT CLASS: 175  
CUBIC FT: 9  
SHIP WEIGHT: 49

**QS**

Grade	1	2	3	4	5	6	7	8	9	10	L	LL
Zone 1	1051	1094	1111	1120	1137	1167	1195	1223	1251	1286	1353	1511
Zone 2	1067	1110	1128	1137	1154	1185	1213	1241	1270	1305	1373	1534
Zone 3	1083	1127	1144	1154	1171	1202	1231	1260	1289	1325	1394	1556

- Thermally fused laminate top available in finishes listed
- Taut-upholstered sides for a contemporary appearance
- See other features in series overview

Finish Options: Natural Maple (FM), Windsor Cherry (WC), Mahogany (M), Graphite (GP), Medium Oak (O), Aspen (AP), Pearwood (PW), Black (E), Espresso (X), Grey (G), Classic Cherry (CC)

**Quick Ship Finishes:** Natural Maple (FM), Windsor Cherry (WC), Aspen (AP), & Black (E)



**5827 Club/Teaming Chair**

24.5" W X 31" D X 34" H

St. Yardage: 3.25

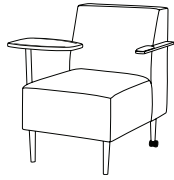

FREIGHT CLASS: 175  
CUBIC FT: 28  
SHIP WEIGHT: 58

**QS**

Grade	1	2	3	4	5	6	7	8	9	10	L	LL
<b>Zone 1</b>	1894	1937	1955	1980	2008	2061	2114	2184	2254	2304	2483	2649
<b>Zone 2</b>	1922	1966	1984	2010	2038	2092	2146	2217	2288	2339	2520	2689
<b>Zone 3</b>	1951	1995	2014	2039	2068	2123	2177	2250	2322	2373	2557	2738

- Sytex sheet webbing
- Solid aluminum handle on back for easy relocation
- Adjustable glides on front and 2.5" casters on back
- Aluminum arm right side facing standard
- Aluminum pole with black or wood finish tablet which rotates 360° on left side facing standard
- Wood finish tablet available in the finishes listed
- See other features in series overview
- Seat: 21.5"W x 20"D x 19.5"H

Finish Options for Tablet: Mahogany (MAH), Windsor Cherry (WC), Classic Cherry (CCY), Walnut (WAL), Honey Cherry (HCY), Natural (FM), Aspen (AP), Moab (MOB), Pearwood (PW) and Rouge Mahogany (RM)

**5827UA Club/Teaming Chair with Upholstered Arms**

30" W X 31" D X 34" H

St. Yardage: 5

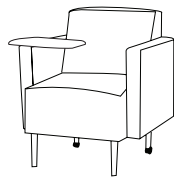

FREIGHT CLASS: 175  
CUBIC FT: 28  
SHIP WEIGHT: 70

**QS**

Grade	1	2	3	4	5	6	7	8	9	10	L	LL
<b>Zone 1</b>	1894	1937	1955	1980	2008	2061	2114	2184	2254	2304	2483	2649
<b>Zone 2</b>	1922	1966	1984	2010	2038	2092	2146	2217	2288	2339	2520	2689
<b>Zone 3</b>	1951	1995	2014	2039	2068	2123	2177	2250	2322	2373	2557	2728

- Sytex sheet webbing
- Fully upholstered seat/back/arms
- Anodized brushed aluminum cylinder legs, adjustable glides on front and 2.5" casters on back
- Black or wood finish tablet rotates 360°
- Tablet easily relocates on left or right
- Wood finish tablet available in the finishes listed
- See other features in series overview
- Seat: 21.5"W x 20"D x 19.5"H

Finish Options for Tablet: Mahogany (MAH), Windsor Cherry (WC), Classic Cherry (CCY), Walnut (WAL), Honey Cherry (HCY), Natural (FM), Aspen (AP), Moab (MOB), Pearwood (PW) and Rouge Mahogany (RM)

**UA Upholstered Arms**

3.75" W X 22" D X 19.5" H

St. Yardage: 3

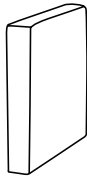

FREIGHT CLASS: 70  
CUBIC FT:  
SHIP WEIGHT: 18

**QS**

Grade	1	2	3	4	5	6	7	8	9	10	L	LL
<b>Zone 1</b>	209	295	329	343	385	441	497	553	610	660	682	810
<b>Zone 2</b>	212	299	334	348	391	448	504	561	619	670	692	822
<b>Zone 3</b>	215	304	339	353	397	454	512	570	628	680	702	834

- UA = 2 upholstered arms
- Add UA to end of item number and price of arms to unit price
- Must be ordered as factory installed

**UAL/UAR Left or Right Upholstered Arm**

3.75" W X 22" D X 19.5" H

St. Yardage: 1.5

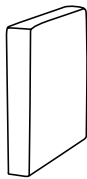

FREIGHT CLASS: 70  
CUBIC FT:  
SHIP WEIGHT: 9

**QS**

Grade	1	2	3	4	5	6	7	8	9	10	L	LL
<b>Zone 1</b>	105	148	165	172	193	221	249	277	305	330	341	405
<b>Zone 2</b>	107	150	167	175	196	224	253	281	310	335	346	411
<b>Zone 3</b>	108	152	170	177	199	228	256	285	314	340	351	417

- UAL = Left arm facing
- UAR = Right arm facing
- Add UAL or UAR to end of item number and add arm price to unit price
- Price is per arm
- Must be ordered as factory installed

**MA Aluminum Arms**

2.25" W X 17" D X 1" H

St. Yardage: n/a

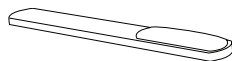

FREIGHT CLASS: 70  
CUBIC FT:  
SHIP WEIGHT: 6

**QS**

Grade	1	2	3	4	5	6	7	8	9	10	L	LL
<b>Zone 1</b>	311	318	326	333	340	350	359	368	378	389	412	464
<b>Zone 2</b>	316	323	331	338	345	355	364	374	384	395	418	471
<b>Zone 3</b>	320	328	336	343	350	361	370	379	389	401	424	478

- MA = 2 aluminum arms
- Add MA to end of item number and add price for arms to unit price
- Must be ordered as factory installed

ALL FOAM & FABRICS USED ARE CAL 117 APPROVED

**QS** indicates a Quickship item if ordered in Quickship upholstery. Quick Ship is not available on any item ordered with options.

**MAL/MAR Left or Right Aluminum Arm**

2.25" W X 17" D X 1" H

St. Yardage: 0.25

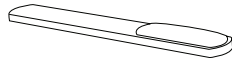

FREIGHT CLASS: 70  
CUBIC FT:  
SHIP WEIGHT: 3

**QS**

Grade	1	2	3	4	5	6	7	8	9	10	L	LL
<b>Zone 1</b>	155	159	163	166	170	174	179	184	188	194	205	232
<b>Zone 2</b>	157	161	165	168	173	177	182	187	191	197	208	235
<b>Zone 3</b>	160	164	168	171	175	179	184	190	194	200	211	239

- MAL = Left arm facing
- MAR = Right arm facing
- Price is per arm

- Add MAL or MAR to end of item number and add arm price to unit price
- Must be ordered as factory installed

**TAL/TAR Tablet Arm on Aluminum Pole**



- TAL = Mounted on left side facing
- TAR = Mounted on right side facing
- Solid aluminum pole attaches to side of seat
- Black or wood finish tablet rotates 360°
- Add TAL or TAR to end of item number and tablet arm price to unit price
- Must be ordered as factory installed

FREIGHT CLASS: 70

**QS**

	Zone Pricing	1	2	3	
17" W X 10.75" D X 19" H	Cubic Ft:	Ship Weight: 8	<b>488</b>	<b>495</b>	<b>503</b>

Finish Options for Tablet: Mahogany (MAH), Windsor Cherry (WC), Classic Cherry (CCY), Walnut (WAL), Honey Cherry (HCY), Natural (FM), Aspen (AP), Moab (MOB), Pearwood (PW) and Rouge Mahogany (RM)

**58B Ganging Bracket Kit**



- 11 gauge steel
- Black powdercoat
- Need one ganging bracket kit for each connection

FREIGHT CLASS: 70

**QS**

8" W X 3" D	Cubic Ft:	Ship Weight: 2	<b>32</b>	<b>32</b>	<b>33</b>
-------------	-----------	----------------	-----------	-----------	-----------

## FINISH SELECTION

ASPEN **AP** | BLACK **BLK** | NATURAL **FM** | HONEY CHERRY **HCY** | ROUGE  
 MAHOGANY **RM** | MAHOGANY **MAH** | MOAB **MOB** | PEARWOOD **PW** | WALNUT  
**WAL** | WINDSOR CHERRY **WC** | CLASSIC CHERRY **CCY** | ESPRESSO **ESP** |

# SIN 711-17 ACCOMPANY

CONTEMPORARY

### Sit Side-By-Side in Comfort

Generous armrests separate and create private space for each individual. Especially suited for public areas and waiting rooms, the gentle curves and substantial visual scale of **Accompany** creates an impression of comfort, encouraging users to relax.

### Accompany Details

- Firm, ergonomically correct cushioning ensures comfort.
- Taut-upholstered for smooth, contemporary appearance
- Solid wood legs



5903 Three Seat Lounge and 5901 Chair

### STANDARD ORDER: SPECIFICATION DETAIL

**5901**      **WC**      **463**      **952**

Base Model      Finish Code      Seat/Back Fabric      Arm Fabric, (if different from Seat/Back fabric)

**Please Note:** If a Two-Color Fabric Combination is desired, additional cost will be incurred. See below.

**Two-Color Combinations:** Add upcharge to the highest fabric price grade featured on unit.

CLUB CHAIR ..... \$53 List      LOVESEAT ..... \$74 List      SOFA..... \$96 List

## Accompany

### 5901 Lounge Chair

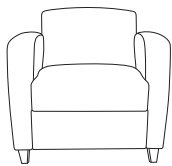

FREIGHT CLASS: 175  
 CUBIC FT: 29  
 SHIP WEIGHT: 73

32.5" W X 29" D X 31" H      St. Yardage: 5      Seat & Back Ydg: 3      Arms Ydg: 3

Grade	1	2	3	4	5	6	7	8	9	10	L	LL
<b>Zone 1</b>	1254	1433	1591	1679	1814	1867	2086	2222	2392	2615	3380	3479
<b>Zone 2</b>	1273	1454	1615	1704	1841	1895	2117	2255	2428	2654	3431	3531
<b>Zone 3</b>	1292	1476	1639	1729	1868	1923	2149	2289	2464	2693	3481	3583

- Tapered arm design
- Adjustable leveling glides
- Extra-thick seat foam
- No-sag spring seat/back suspensions
- Hardwood frame
- Optional tablets are located on outside of arm, specify left or right facing and indicate finish
- Seat: 21" W x 19" D x 19" H

OPTION	PRICE	CODE
Softer Seat Foam-Chair	16.00	SF
Genesis Tablet	514.00	GT
Pivoting Tablet	514.00	LT
Double Pivot Tablet	689.00	DT

CASTER OPTION	PRICE	CODE
4 Accompany Locking Casters	85.00	AC

**QS**

### 5902 Two Seat Lounge



FREIGHT CLASS: 175  
 CUBIC FT: 42  
 SHIP WEIGHT: 146

59.75" W X 29" D X 31" H      St. Yardage: 9      Seat & Back Ydg: 6      Arms Ydg: 4.5

Grade	1	2	3	4	5	6	7	8	9	10	L	LL
<b>Zone 1</b>	2121	2424	2683	2776	2851	3015	3175	3296	3552	3786	5764	5948
<b>Zone 2</b>	2153	2460	2723	2818	2894	3060	3223	3345	3605	3843	5850	6037
<b>Zone 3</b>	2185	2497	2763	2859	2937	3105	3270	3395	3659	3900	5937	6126

- Tapered arm design
- Adjustable levelling glides
- Extra-thick seat foam
- No-sag spring seat/back suspensions
- Hardwood frame
- Optional tablets are located on outside of end arms only, specify left or right facing and indicate finish
- Each seat: 21" W x 19" D x 19" H

OPTION	PRICE	CODE
Softer Seat Foam-Loveseat	32.00	SF
Genesis Tablet	514.00	GT
Pivoting Tablet	514.00	LT
Double Pivot Tablet	689.00	DT

**QS**

ALL FOAM & FABRICS USED ARE CAL 117 APPROVED

**QS** indicates a Quickship item if ordered in Quickship upholstery. Quick Ship is not available on any item ordered with options.

# ACCOMPANY

SIN 711-17

## FINISH SELECTION

ASPEN AP | BLACK BLK | NATURAL FM | HONEY CHERRY HCY | ROUGE MAHOGANY RM | MAHOGANY MAH | MOAB MOB | PEARWOOD PW | WALNUT WAL | WINDSOR CHERRY WC | CLASSIC CHERRY CCY | ESPRESSO ESP |

CONTEMPORARY

### 5903 Three Seat Lounge

86.5" W X 29" D X 31" H

St. Yardage: 12.5

Seat & Back Ydg: 8

Arms Ydg: 5.5

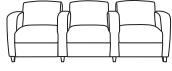

FREIGHT CLASS: 175  
CUBIC FT: 66  
SHIP WEIGHT: 178

Grade	1	2	3	4	5	6	7	8	9	10	L	LL
Zone 1	2965	3404	3800	3984	4139	4310	4436	4962	5288	5696	8244	8405
Zone 2	3009	3455	3857	4044	4201	4375	4503	5036	5367	5781	8368	8531
Zone 3	3054	3506	3914	4104	4263	4439	4569	5111	5447	5867	8491	8657

- Tapered arm design
- Adjustable levelling glides
- Extra-thick seat foam
- No-sag spring seat/back suspensions
- Hardwood frame
- Optional tablets are located on outside of end arms only, specify left or right facing and indicate finish
- Each seat: 21"W x 19"D x 19"H

OPTION	PRICE	CODE
Softer Seat Foam-Sofa	48.00	SF
Genesis Tablet	514.00	GT
Pivoting Tablet	514.00	LT
Double Pivot Tablet	689.00	DT

**QS**

### 5965-OF 60° Outside Facing Loveseat

70" W X 32.5" D X 32.5" H

St. Yardage: 7

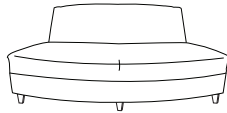

FREIGHT CLASS: 175  
CUBIC FT: 74  
SHIP WEIGHT: 121

Grade	1	2	3	4	5	6	7	8	9	10	L	LL
Zone 1	2056	2061	2284	2456	2582	2751	2866	3018	3256	3467	3583	3967
Zone 2	2087	2194	2318	2493	2621	2792	2909	3063	3305	3519	3637	4027
Zone 3	2118	2226	2353	2530	2659	2834	2952	3109	3354	3571	3690	4086

- Extra-thick high density foam
- No-sag sinuous wire spring suspension
- Use with other 60° or 30° curved units to form curves in reception layout
- Can also be used with Accompany armless chair
- Seat: 52.5-70"W x 19"D x 19"H

OPTION	PRICE	CODE
Softer Seat Foam-Loveseat	32.00	SF

**QS**

### 5965-IF 60° Inside Facing Loveseat

70" W X 32.5" D X 32.5" H

St. Yardage: 7.75

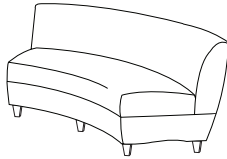

FREIGHT CLASS: 175  
CUBIC FT: 74  
SHIP WEIGHT: 121

Grade	1	2	3	4	5	6	7	8	9	10	L	LL
Zone 1	2056	2061	2284	2456	2582	2751	2866	3018	3256	3467	3583	3967
Zone 2	2087	2194	2318	2493	2621	2792	2909	3063	3305	3519	3637	4027
Zone 3	2118	2226	2353	2530	2659	2834	2952	3109	3354	3571	3690	4086

- Extra-thick high density foam
- No-sag sinuous wire spring suspension
- Use with other 60° or 30° curved units to form curves in reception layout
- Can also be used with Accompany armless chair
- Seat: 43-63"W x 19"D x 19"H

OPTION	PRICE	CODE
Softer Seat Foam-Loveseat	32.00	SF

**QS**

### 5935-OF 30° Outside Facing Chair

38" W X 31" D X 32.5" H

St. Yardage: 4

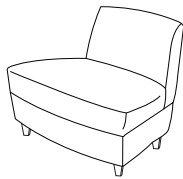

FREIGHT CLASS: 175  
CUBIC FT: 31  
SHIP WEIGHT: 65

Grade	1	2	3	4	5	6	7	8	9	10	L	LL
Zone 1	1349	1403	1467	1556	1621	1708	1791	1882	1969	2077	2137	2473
Zone 2	1369	1424	1489	1579	1645	1734	1818	1910	1999	2108	2169	2510
Zone 3	1389	1445	1511	1603	1670	1759	1845	1938	2028	2139	2201	2547

- Extra-thick high density foam
- No-sag sinuous wire spring suspension
- Use with other 60° or 30° curved units to form curves in reception layout
- Can also be used with Accompany armless chair
- Seat: 27.5-34.5"W x 19"D x 19"H

OPTION	PRICE	CODE
Softer Seat Foam-Chair	16.00	SF

**QS**

### 5935-IF 30° Inside Facing Chair

38" W X 31" D X 32.5" H

St. Yardage: 4.75

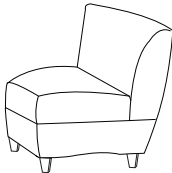

FREIGHT CLASS: 175  
CUBIC FT: 31  
SHIP WEIGHT: 60

Grade	1	2	3	4	5	6	7	8	9	10	L	LL
Zone 1	1349	1403	1467	1556	1621	1708	1791	1882	1969	2077	2137	2473
Zone 2	1369	1424	1489	1579	1645	1734	1818	1910	1999	2108	2169	2510
Zone 3	1389	1445	1511	1603	1670	1759	1845	1938	2028	2139	2201	2547

- Extra-thick high density foam
- No-sag sinuous wire spring suspension
- Use with other 60° or 30° curved units to form curves in reception layout
- Can also be used with Accompany armless chair
- Seat: 21.25-30.75"W x 19"D x 19"H

OPTION	PRICE	CODE
Softer Seat Foam-Chair	16.00	SF

**QS**

350 - ACCOMPANY

**QS** ALL FOAM & FABRICS USED ARE CAL 117 APPROVED  
indicates a Quickship item if ordered in Quickship upholstery.  
Quick Ship is not available on any item ordered with options.

# FINISH SELECTION

ASPEN **AP** | BLACK **BLK** | NATURAL **FM** | HONEY CHERRY **HCY** | ROUGE  
 MAHOGANY **RM** | MAHOGANY **MAH** | MOAB **MOB** | PEARWOOD **PW** | WALNUT  
**WAL** | WINDSOR CHERRY **WC** | CLASSIC CHERRY **CCY** | ESPRESSO **ESP** |

# SIN 711-17 ACCOMPANY MODULAR

CONTEMPORARY

CONTEMPORARY

## 5924 Connecting/Freestanding Table

23" W X 27" D X 13" H

St. Yardage: 1.5

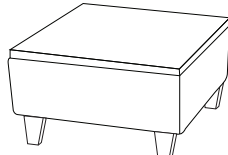

FREIGHT CLASS: 175  
 CUBIC FT: 10  
 SHIP WEIGHT: 49

Grade	1	2	3	4	5	6	7	8	9	10	L	LL
Zone 1	974	994	1018	1044	1067	1096	1126	1156	1185	1222	1270	1459
Zone 2	989	1009	1033	1060	1083	1112	1143	1173	1203	1240	1289	1481
Zone 3	1003	1024	1049	1075	1099	1129	1160	1191	1221	1259	1308	1503

- Thermally fused laminate top available in finishes listed
- Contemporary taut upholstered sides

- Use with Accompany curved units and armless chair

Top Finish Options: Natural Maple (FM), Windsor Cherry (WC), Mahogany (M), Graphite (GP), Medium Oak (O), Aspen (AP), Pearwood (PW), Black (E), Espresso (X), Grey (G), Classic Cherry (CC)

**QS**

**Quick Ship Finishes:** Windsor Cherry, Natural Maple, Aspen, Black & Mahogany

## 5925 Wedge Table

36" W X 28" D X 13" H

St. Yardage: 1.5

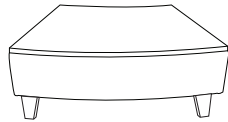

FREIGHT CLASS: 175  
 CUBIC FT: 16  
 SHIP WEIGHT: 64

Grade	1	2	3	4	5	6	7	8	9	10	L	LL
Zone 1	1004	1024	1048	1074	1097	1126	1156	1186	1215	1252	1300	1423
Zone 2	1019	1039	1064	1090	1113	1143	1173	1204	1233	1271	1320	1444
Zone 3	1034	1055	1079	1106	1130	1160	1191	1222	1251	1290	1339	1466

- Thermally fused laminate top available in finishes listed
- Contemporary taut upholstered sides

- Use with Accompany curved units to form curves in reception layouts
- Can also be used with Accompany armless chair

Top Finish Options: Natural Maple (FM), Windsor Cherry (WC), Mahogany (M), Graphite (GP), Medium Oak (O), Aspen (AP), Pearwood (PW), Black (E), Espresso (X), Grey (G), Classic Cherry (CC)

**QS**

**Quick Ship Finishes:** Windsor Cherry, Natural Maple, Aspen, Black & Mahogany

## 5904 Armless Chair

22" W X 29" D X 31" H

St. Yardage: 3.5

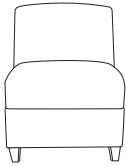

FREIGHT CLASS: 175  
 CUBIC FT: 19  
 SHIP WEIGHT: 43

Grade	1	2	3	4	5	6	7	8	9	10	L	LL
Zone 1	876	945	1017	1083	1148	1235	1268	1409	1496	1604	1922	2200
Zone 2	889	959	1032	1099	1165	1254	1287	1430	1518	1628	1951	2233
Zone 3	902	973	1048	1115	1182	1272	1306	1451	1541	1652	1980	2266

- Adjustable leveling glides
- Extra-thick seat foam
- No-sag spring seat/back suspensions

- Hardwood frame
- Seat: 22"W x 19"D x 19"H

OPTION	PRICE	CODE
Softer Seat Foam-Chair	16.00	SF
CASTER OPTION	PRICE	CODE
4 Accompany Locking Casters	85.00	AC

**QS**

## 5905 Loveseat

54.5" W X 29" D X 31" H

St. Yardage: 8.5

Seat & Back Ydg: 6

Arms Ydg: 3

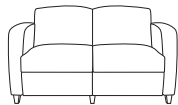

FREIGHT CLASS: 175  
 CUBIC FT: 41  
 SHIP WEIGHT: 108

Grade	1	2	3	4	5	6	7	8	9	10	L	LL
Zone 1	1786	1961	2137	2302	2465	2683	2767	3118	3335	3607	4400	4736
Zone 2	1813	1990	2169	2337	2502	2723	2809	3165	3385	3661	4466	4807
Zone 3	1840	2020	2201	2371	2539	2763	2850	3212	3435	3715	4532	4878

- Tapered arm design
- Adjustable leveling glides
- Extra-thick seat foam
- No-sag spring seat/back suspensions

- Hardwood frame
- Optional tablets are located on outside of arm, specify left or right facing and indicate finish
- Seat: 43.5"W x 19"D x 19"H

OPTION	PRICE	CODE
Softer Seat Foam-Loveseat	32.00	SF
Genesis Tablet	514.00	GT
Pivoting Tablet	514.00	LT
Double Pivot Tablet	689.00	DT

**QS**

## 5906 Sofa

76" W X 29" D X 31" H

St. Yardage: 10.5

Seat & Back Ydg: 8.5

Arms Ydg: 3



FREIGHT CLASS: 175  
 CUBIC FT: 20  
 SHIP WEIGHT: 67

Grade	1	2	3	4	5	6	7	8	9	10	L	LL
Zone 1	2511	2748	2987	3208	3428	3722	3835	4309	4602	4969	6042	6517
Zone 2	2549	2789	3032	3256	3479	3778	3893	4374	4671	5044	6133	6615
Zone 3	2586	2830	3077	3304	3531	3834	3950	4438	4740	5118	6223	6713

- Adjustable leveling glides
- Tapered arm design
- Extra-thick seat foam
- Hardwood frame

- No-sag spring seat/back suspensions
- Seat: 65"W x 19"D x 19"H

OPTION	PRICE	CODE
Softer Seat Foam-Sofa	48.00	SF
Genesis Tablet	514.00	GT
Pivoting Tablet	514.00	LT
Double Pivot Tablet	689.00	DT

**QS**

**ALL FOAM & FABRICS USED ARE CAL 117 APPROVED**

**QS** indicates a Quickship item if ordered in Quickship upholstery. Quick Ship is not available on any item ordered with options.

# ACCOMPANY MODULAR

SIN 711-17

## FINISH SELECTION

ASPEN **AP** | BLACK **BLK** | NATURAL **FM** | HONEY CHERRY **HCY** | ROUGE  
 MAHOGANY **RM** | MAHOGANY **MAH** | MOAB **MOB** | PEARWOOD **PW** | WALNUT  
 WAL | WINDSOR CHERRY **WC** | CLASSIC CHERRY **CCY** | ESPRESSO **ESP** |

CONTEMPORARY

### Sit Side-By-Side in Comfort

Generous armrests separate and create private space for each individual. Especially suited for public areas and waiting rooms, the gentle curves and substantial visual scale of **Accompany** creates an impression of comfort, encouraging users to relax.

### Accompany Modular Details

- Firm, ergonomically correct cushioning ensures comfort.
- Two-color fabric combination available
- Wood legs with adjustable leveling glides
- Requires easy bolt-on assembly



### STANDARD ORDER: SPECIFICATION DETAIL

**5913**

Base Model

**WC**

Wood Finish

**463**

Seat/Back Fabric

**952**

Arm Fabric, (if different from Seat/Back fabric)

**Please Note:** If a Two-Color Fabric Combination is desired, additional cost will be incurred. See below.

**Two-Color Combinations:** Add upcharge to the highest fabric price grade featured on unit.

CLUB CHAIR ..... \$53 List      LOVESEAT ..... \$74 List      SOFA ..... \$96 List

### MODULAR ORDER DETAIL:

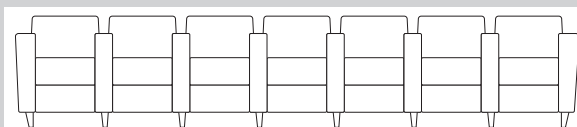

This Accompany Modular order would consist of the following model numbers:

- (1) 5913 Left End Unit
- (1) 5914 Right End Unit
- (7) 5911 Center Seats
- (6) 5912 Center Arms

## Accompany Modular

### 5911 Center Seat, Requires Two 5912 Center Arms

22" W X 29" D X 31" H

St. Yardage: 3

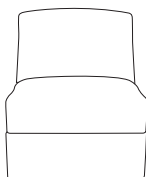

FREIGHT CLASS: 175  
 CUBIC FT: 20  
 SHIP WEIGHT: 67

Grade	1	2	3	4	5	6	7	8	9	10	L	LL
Zone 1	585	677	767	823	899	928	1051	1127	1222	1403	1662	1831
Zone 2	594	687	779	835	912	942	1067	1144	1240	1424	1687	1858
Zone 3	603	697	790	848	926	956	1083	1161	1259	1445	1712	1886

- Extra-thick seat foam
- No-sag spring seat/back suspensions
- Hardwood frame
- Requires easy bolt-on assembly
- Seat: 21" W x 19" D x 19" H

OPTION	PRICE	CODE
Softer Seat Foam-Chair	16.00	SF

### QS

### 5912 Center Arm

6" W X 29" D X 25.5" H

St. Yardage: 1.75

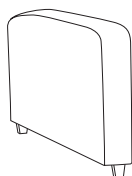

FREIGHT CLASS: 70  
 CUBIC FT: 4.3  
 SHIP WEIGHT: 20

Grade	1	2	3	4	5	6	7	8	9	10	L	LL
Zone 1	318	368	411	437	475	490	551	589	637	727	910	981
Zone 2	323	374	417	444	482	497	559	598	647	738	924	996
Zone 3	328	379	423	450	489	505	568	607	656	749	937	1010

- Wood legs in finishes listed above
- Hardwood frame
- Requires easy bolt-on assembly

### QS

### 5913 Left Arm Unit, Ships with Arm/Seat Assembled

26.5" W X 29" D X 31" H

St. Yardage: 4.75

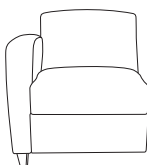

FREIGHT CLASS: 175  
 CUBIC FT: 16  
 SHIP WEIGHT: 55

Grade	1	2	3	4	5	6	7	8	9	10	L	LL
Zone 1	920	1067	1198	1277	1391	1435	1619	1733	1876	2147	2389	2703
Zone 2	934	1083	1216	1296	1412	1457	1643	1759	1904	2179	2425	2744
Zone 3	948	1099	1234	1315	1433	1478	1668	1785	1932	2211	2461	2784

- Tapered arm design
- Wood legs in finishes listed above
- Extra-thick seat foam
- No-sag spring seat/back suspensions
- Hardwood frame
- Requires easy bolt-on assembly
- Seat: 21" W x 19" D x 19" H

OPTION	PRICE	CODE
Softer Seat Foam-Chair	16.00	SF

### QS

## 352 - ACCOMPANY MODULAR

**QS** ALL FOAM & FABRICS USED ARE CAL 117 APPROVED indicates a Quickship item if ordered in Quickship upholstery. Quick Ship is not available on any item ordered with options.



FINISH SELECTION

ASPEN **AP** | BLACK **BLK** | NATURAL **FM** | HONEY CHERRY **HCY** | ROUGE  
 MAHOGANY **RM** | MAHOGANY **MAH** | MOAB **MOB** | PEARWOOD **PW** | WALNUT  
**WAL** | WINDSOR CHERRY **WC** | CLASSIC CHERRY **CCY** | ESPRESSO **ESP** |

SIN 711-17 **ACCOMPANY MODULAR**

**5914 Right Arm Unit, Ships with Arm/Seat Assembled**

26.5" W X 29" D X 31" H

St. Yardage: 4.75

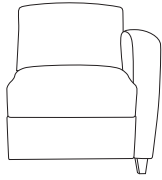

FREIGHT CLASS: 175  
 CUBIC FT: 16  
 SHIP WEIGHT: 55

Grade	1	2	3	4	5	6	7	8	9	10	L	LL
<b>Zone 1</b>	<b>920</b>	<b>1067</b>	<b>1198</b>	<b>1277</b>	<b>1391</b>	<b>1435</b>	<b>1619</b>	<b>1733</b>	<b>1876</b>	<b>2147</b>	<b>2389</b>	<b>2703</b>
<b>Zone 2</b>	<b>934</b>	<b>1083</b>	<b>1216</b>	<b>1296</b>	<b>1412</b>	<b>1457</b>	<b>1643</b>	<b>1759</b>	<b>1904</b>	<b>2179</b>	<b>2425</b>	<b>2744</b>
<b>Zone 3</b>	<b>948</b>	<b>1099</b>	<b>1234</b>	<b>1315</b>	<b>1433</b>	<b>1478</b>	<b>1668</b>	<b>1785</b>	<b>1932</b>	<b>2211</b>	<b>2461</b>	<b>2784</b>

- Tapered arm design
- Wood legs in finishes listed above
- Extra-thick seat foam
- No-sag spring seat/back suspensions

- Hardwood frame
- Requires easy bolt-on assembly
- Seat: 21"W x 19"D x 19"H

OPTION	PRICE	CODE
Softer Seat Foam-Chair	16.00	SF

**QS**

CONTEMPORARY

ALL FOAM & FABRICS USED ARE CAL 117 APPROVED

**QS** indicates a Quickship item if ordered in Quickship upholstery. Quick Ship is not available on any item ordered with options.

# ACCOMPANY METAL LEG SIN 711-17

CONTEMPORARY

## Sit Side-By-Side in Comfort

Generous armrests separate and create private space for each individual. Especially suited for public areas and waiting rooms, the gentle curves and substantial visual scale of **Accompany** creates an impression of comfort, encouraging users to relax.

### Accompany Metal Details

- Firm, ergonomically correct cushioning ensures comfort.
- Taut-upholstered for smooth, contemporary appearance
- Brushed aluminum cylinder legs



5901MET Chair

### STANDARD ORDER: SPECIFICATION DETAIL

<b>5901MET</b>	<b>463</b>	<b>952</b>
Base Model	Seat/Back Fabric	Arm Fabric, (if different from Seat/Back fabric)

**Please Note:** If a Two-Color Fabric Combination is desired, additional cost will be incurred. See below.

**Two-Color Combinations:** Add upcharge to the highest fabric price grade featured on unit.

CLUB CHAIR ..... \$53 List      LOVESEAT ..... \$74 List      SOFA ..... \$96 List

### MODULAR ORDER DETAIL:

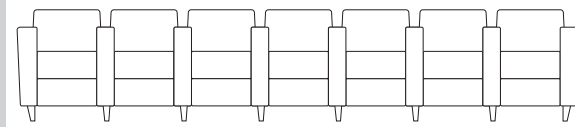

This Accompany Metal Modular order would consist of the following model numbers:

- (1) 5913MET Left End Unit
- (1) 5914MET Right End Unit
- (7) 5911 Center Seats
- (6) 5912MET Center Arms

## Accompany Metal Leg

### 5901MET Lounge Chair

32.5" W X 29" D X 32.5" H      St. Yardage: 5      Seat & Back Ydg: 3      Arms Ydg: 3

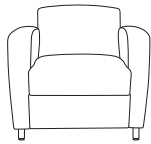

FREIGHT CLASS: 175  
CUBIC FT: 31  
SHIP WEIGHT: 74

Grade	1	2	3	4	5	6	7	8	9	10	L	LL
<b>Zone 1</b>	1317	1487	1640	1742	1877	1930	2052	2149	2285	2455	3344	3542
<b>Zone 2</b>	1337	1509	1665	1768	1905	1959	2083	2181	2319	2492	3394	3595
<b>Zone 3</b>	1357	1532	1689	1794	1933	1988	2114	2213	2354	2529	3444	3648

- Chrome leg levelers
- Extra-thick, high-density cushions
- No-sag sinuous wire spring seat and back suspensions
- Optional tablets are located on outside of arm, specify left or right facing and indicate finish
- Seat: 21" W x 19" D x 19" H

OPTION	PRICE	CODE
Softer Seat Foam-Chair	16.00	SF
Genesis Tablet	514.00	GT
Pivoting Tablet	514.00	LT
Double Pivot Tablet	689.00	DT

QS

### 5902MET Two-Seat Lounge

59.75" W X 29" D X 32.5" H      St. Yardage: 9      Seat & Back Ydg: 6      Arms Ydg: 4.5

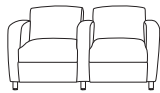

FREIGHT CLASS: 70  
CUBIC FT: 51  
SHIP WEIGHT: 148

Grade	1	2	3	4	5	6	7	8	9	10	L	LL
<b>Zone 1</b>	2206	2495	2743	2936	3170	3260	3444	3637	3871	4163	5118	5673
<b>Zone 2</b>	2239	2532	2784	2980	3218	3309	3496	3692	3929	4225	5195	5758
<b>Zone 3</b>	2272	2570	2825	3024	3265	3358	3547	3746	3987	4288	5272	5843

- Chrome leg levelers
- Extra-thick, high-density cushions
- No-sag sinuous wire spring seat and back suspensions
- Center arm separates seats
- Optional tablets are located on outside of end arms only, specify left or right facing and indicate finish
- Each seat: 21" W x 19" D x 19" H

OPTION	PRICE	CODE
Softer Seat Foam-Loveseat	32.00	SF
Genesis Tablet	514.00	GT
Pivoting Tablet	514.00	LT
Double Pivot Tablet	689.00	DT

QS

### 5903MET Three-Seat Lounge

86.5" W X 29" D X 32.5" H      St. Yardage: 12.5      Seat & Back Ydg: 8      Arms Ydg: 5.5

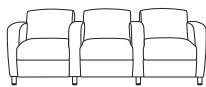

FREIGHT CLASS: 175  
CUBIC FT: 68  
SHIP WEIGHT: 178

Grade	1	2	3	4	5	6	7	8	9	10	L	LL
<b>Zone 1</b>	3081	3499	3876	4100	4426	4652	5078	5404	5812	6586	8108	8421
<b>Zone 2</b>	3127	3551	3934	4162	4492	4722	5154	5485	5899	6685	8230	8547
<b>Zone 3</b>	3173	3604	3992	4223	4559	4792	5230	5566	5986	6784	8351	8674

- Chrome leg levelers
- Extra-thick, high-density cushions
- No-sag sinuous wire spring seat and back suspensions
- Center arms separate seats
- Optional tablets are located on outside of end arms only, specify left or right facing and indicate finish
- Each seat: 21" W x 19" D x 19" H

OPTION	PRICE	CODE
Softer Seat Foam-Sofa	48.00	SF
Genesis Tablet	514.00	GT
Pivoting Tablet	514.00	LT
Double Pivot Tablet	689.00	DT

QS

## 354 - ACCOMPANY METAL LEG

QS

**ALL FOAM & FABRICS USED ARE CAL 117 APPROVED**  
indicates a Quickship item if ordered in Quickship upholstery.  
Quick Ship is not available on any item ordered with options.

# SIN 711-17 ACCOMPANY METAL LEG

CONTEMPORARY

## 5965MET-OF 60° Curved Loveseat, Outside Facing

70" W X 32.5" D X 32.5" H

St. Yardage: 7

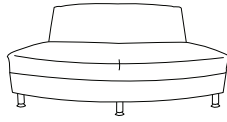

FREIGHT CLASS: 175  
CUBIC FT: 74  
SHIP WEIGHT: 125

**QS**

Grade	1	2	3	4	5	6	7	8	9	10	L	LL
Zone 1	2056	2061	2284	2456	2582	2751	2866	3018	3256	3467	3583	3967
Zone 2	2087	2194	2318	2493	2621	2792	2909	3063	3305	3519	3637	4027
Zone 3	2118	2226	2353	2530	2659	2834	2952	3109	3354	3571	3690	4086

- Extra-thick high density cushions
- No-sag sinuous wire spring suspension
- Brushed aluminum cylinder legs with chrome leg levelers
- Cannot be connected
- Use with other 60° or 30° curved units to form curves in reception layout
- Can also be used with Accompany Metal armless chair
- Seat: 52.5-70" W X 19" D X 19" H

OPTION	PRICE	CODE
Softer Seat Foam-Loveseat	32.00	SF

## 5965MET-IF 60° Curved Loveseat, Inside Facing

70" W X 32.5" D X 32.5" H

St. Yardage: 7.75

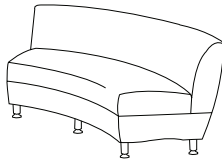

FREIGHT CLASS: 175  
CUBIC FT: 74  
SHIP WEIGHT: 120

**QS**

Grade	1	2	3	4	5	6	7	8	9	10	L	LL
Zone 1	2056	2061	2284	2456	2582	2751	2866	3018	3256	3467	3583	3967
Zone 2	2087	2194	2318	2493	2621	2792	2909	3063	3305	3519	3637	4027
Zone 3	2118	2226	2353	2530	2659	2834	2952	3109	3354	3571	3690	4086

- Extra-thick high density cushions
- No-sag sinuous wire spring suspension
- Brushed aluminum cylinder legs with chrome leg levelers
- Cannot be connected
- Use with other 60° or 30° curved units to form curves in reception layout
- Can also be used with Accompany Metal armless chair
- Seat: 43-63" W X 19" D X 19" H

OPTION	PRICE	CODE
Softer Seat Foam-Loveseat	32.00	SF

## 5935MET-OF 30° Curved Chair, Outside Facing

38" W X 32" D X 32.5" H

St. Yardage: 4

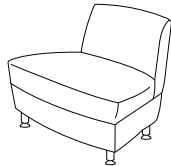

FREIGHT CLASS: 175  
CUBIC FT: 31  
SHIP WEIGHT: 60

**QS**

Grade	1	2	3	4	5	6	7	8	9	10	L	LL
Zone 1	1349	1403	1467	1556	1621	1708	1791	1882	1969	2077	2137	2473
Zone 2	1369	1424	1489	1579	1645	1734	1818	1910	1999	2108	2169	2510
Zone 3	1389	1445	1511	1603	1670	1759	1845	1938	2028	2139	2201	2547

- Extra-thick high density cushions
- No-sag sinuous wire spring suspension
- Brushed aluminum cylinder legs with chrome leg levelers
- Can also be used with Accompany Metal armless chair
- Use with other 60° or 30° curved units to form curves in reception layout
- Cannot be connected
- Seat: 27.5-34.5" W X 19" D X 19" H

OPTION	PRICE	CODE
Softer Seat Foam-Chair	16.00	SF

## 5935MET-IF 30° Curved Chair, Inside Facing

38" W X 31" D X 32.5" H

St. Yardage: 4.75

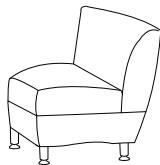

FREIGHT CLASS: 175  
CUBIC FT: 31  
SHIP WEIGHT: 60

**QS**

Grade	1	2	3	4	5	6	7	8	9	10	L	LL
Zone 1	1349	1403	1467	1556	1621	1708	1791	1882	1969	2077	2137	2473
Zone 2	1369	1424	1489	1579	1645	1734	1818	1910	1999	2108	2169	2510
Zone 3	1389	1445	1511	1603	1670	1759	1845	1938	2028	2139	2201	2547

- Extra-thick high density cushions
- No-sag sinuous wire spring suspension
- Brushed aluminum cylinder legs with chrome leg levelers
- Use with other 60° or 30° curved units to form curves in reception layout
- Can also be used with Accompany Metal armless chair
- Cannot be connected
- Seat: 21.25-30.75" W X 19" D X 19" H

OPTION	PRICE	CODE
Softer Seat Foam-Chair	16.00	SF

## 5924MET Connecting/Freestanding Table

23" W X 27" D X 13" H

St. Yardage: 1.5

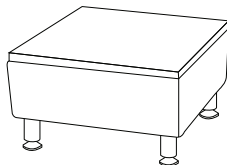

FREIGHT CLASS: 175  
CUBIC FT: 10  
SHIP WEIGHT: 49

**QS**

Grade	1	2	3	4	5	6	7	8	9	10	L	LL
Zone 1	974	994	1018	1044	1067	1096	1126	1156	1185	1222	1270	1459
Zone 2	989	1009	1033	1060	1083	1112	1143	1173	1203	1240	1289	1481
Zone 3	1003	1024	1049	1075	1099	1129	1160	1191	1221	1259	1308	1503

- Thermally fused laminate top available in finishes listed
- Contemporary taut upholstered sides
- Brushed aluminum cylinder legs with chrome leg levelers

Top Finish Options: Natural Maple (FM), Windsor Cherry (WC), Mahogany (M), Graphite (GP), Medium Oak (O), Aspen (AP), Pearwood (PW), Black (E), Espresso (X), Grey (G), Classic Cherry (CC)

Quick Ship Finishes: Windsor Cherry, Natural Maple, Aspen, Black & Mahogany

ALL FOAM & FABRICS USED ARE CAL 117 APPROVED

**QS** indicates a Quickship item if ordered in Quickship upholstery. Quick Ship is not available on any item ordered with options.

# ACCOMPANY METAL LEG SIN 711-17

CONTEMPORARY

## 5925MET Wedge Table

36" W X 28" D X 13" H

St. Yardage: 1.5

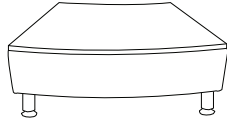

FREIGHT CLASS: 175  
CUBIC FT: 16  
SHIP WEIGHT: 64

Grade	1	2	3	4	5	6	7	8	9	10	L	LL
Zone 1	1004	1024	1048	1074	1097	1126	1156	1186	1215	1252	1300	1423
Zone 2	1019	1039	1064	1090	1113	1143	1173	1204	1233	1271	1320	1444
Zone 3	1034	1055	1079	1106	1130	1160	1191	1222	1251	1290	1339	1466

- Thermally fused laminate top available in finishes listed
- Contemporary taut upholstered sides
- Bushed aluminum cylinder legs with chrome leg levelers
- Use with Accompany Metal curved units to form curves in reception layouts

Top Finish Options: Natural Maple (FM), Windsor Cherry (WC), Mahogany (M), Graphite (GP), Medium Oak (O), Aspen (AP), Pearwood (PW), Black (E), Espresso (X), Grey (G), Classic Cherry (CC)

QS

Quick Ship Finishes: Windsor Cherry, Natural Maple, Aspen, Black & Mahogany

## 5904MET Armless Chair

22" W X 29" D X 32.5" H

St. Yardage: 3.5

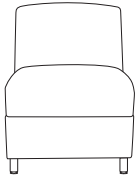

FREIGHT CLASS: 175  
CUBIC FT: 20  
SHIP WEIGHT: 44

Grade	1	2	3	4	5	6	7	8	9	10	L	LL
Zone 1	958	1025	1092	1165	1230	1317	1350	1491	1578	1686	1955	2382
Zone 2	972	1040	1108	1182	1248	1337	1370	1513	1602	1711	1984	2418
Zone 3	987	1056	1125	1200	1267	1357	1391	1536	1625	1737	2014	2453

- Chrome leg levelers
- Extra-thick, high-density cushions
- No-sag sinuous wire spring seat and back suspensions
- Seat: 21"W x 19"D x 19"H

OPTION	PRICE	CODE
Softer Seat Foam-Chair	16.00	SF

QS

## 5905MET Loveseat

54.5" W X 29" D X 32.5" H

St. Yardage: 8.5

Seat & Back Ydg: 6

Arms Ydg: 3

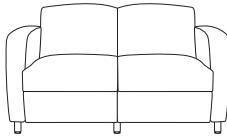

FREIGHT CLASS: 175  
CUBIC FT: 41  
SHIP WEIGHT: 123

Grade	1	2	3	4	5	6	7	8	9	10	L	LL
Zone 1	1886	2053	2221	2402	2565	2783	2867	3218	3435	3707	4375	5146
Zone 2	1914	2084	2254	2438	2603	2825	2910	3266	3487	3763	4441	5223
Zone 3	1943	2115	2288	2474	2642	2866	2953	3315	3538	3818	4506	5300

- Chrome leg levelers
- Extra-thick, high-density cushions
- No-sag sinuous wire spring seat and back suspensions
- Optional tablets are located on outside of arm, specify left or right facing and indicate finish
- Seat: 43.5"W x 19"D x 19"H

OPTION	PRICE	CODE
Softer Seat Foam-Loveseat	32.00	SF
Genesis Tablet	514.00	GT
Pivoting Tablet	514.00	LT
Double Pivot Tablet	689.00	DT

QS

## 5906MET Sofa

76" W X 29" D X 32.5" H

St. Yardage: 10.5

Seat & Back Ydg: 8.5

Arms Ydg: 3

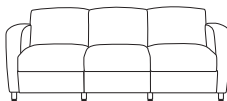

FREIGHT CLASS: 175  
CUBIC FT: 68  
SHIP WEIGHT: 155

Grade	1	2	3	4	5	6	7	8	9	10	L	LL
Zone 1	2639	2864	3092	3336	3556	3850	3963	4437	4730	5097	6002	6694
Zone 2	2679	2907	3138	3386	3609	3908	4022	4504	4801	5173	6092	6794
Zone 3	2718	2950	3185	3436	3663	3966	4082	4570	4872	5250	6182	6895

- Chrome leg levelers
- Extra-thick, high-density foam cushions
- No-sag sinuous wire spring seat and back suspensions
- Optional tablets are located on outside of arm, specify left or right facing and indicate finish
- Seat: 65"W x 19"D x 19"H

OPTION	PRICE	CODE
Softer Seat Foam-Sofa	48.00	SF
Genesis Tablet	514.00	GT
Pivoting Tablet	514.00	LT
Double Pivot Tablet	689.00	DT

QS

## 5911 Center Seat, Requires Two 5912 Center Arms

22" W X 29" D X 31" H

St. Yardage: 3

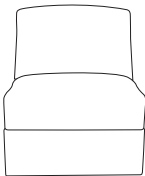

FREIGHT CLASS: 175  
CUBIC FT: 20  
SHIP WEIGHT: 67

Grade	1	2	3	4	5	6	7	8	9	10	L	LL
Zone 1	585	677	767	823	899	928	1051	1127	1222	1403	1662	1831
Zone 2	594	687	779	835	912	942	1067	1144	1240	1424	1687	1858
Zone 3	603	697	790	848	926	956	1083	1161	1259	1445	1712	1886

- Extra-thick seat foam
- No-sag spring seat/back suspensions
- Hardwood frame
- Requires easy bolt-on assembly
- Seat: 21"W x 19"D x 19"H

OPTION	PRICE	CODE
Softer Seat Foam-Chair	16.00	SF
Center Seat with one Center Arm: Cube Ft: 20, Ship Wt: 63		
Center Seat with two Center Arms: Cubic Ft: 22.4, Ship Wt: 83		

QS

# SIN 711-17 ACCOMPANY METAL LEG

CONTEMPORARY

## 5912MET Center Arm

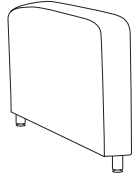

FREIGHT CLASS: 70  
CUBIC FT: 6  
SHIP WEIGHT: 20

6" W X 29" D X 27" H

St. Yardage: 1.75

Grade	1	2	3	4	5	6	7	8	9	10	L	LL
Zone 1	365	413	453	484	522	537	559	598	636	684	774	929
Zone 2	370	419	460	491	530	545	567	607	646	694	786	943
Zone 3	376	425	467	499	538	553	576	616	655	705	797	957

- Chrome leg levelers
- Easy bolt-on assembly
- Ships with 5911 center seat

### QS

## 5913MET Left Arm Unit, Ships with Arm/Seat Assembled

26.5" W X 29" D X 32.5" H

St. Yardage: 4.75

Seat & Back Ydg: 3

Arms Ydg: 1.75

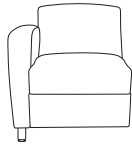

FREIGHT CLASS: 175  
CUBIC FT: 28  
SHIP WEIGHT: 56

Grade	1	2	3	4	5	6	7	8	9	10	L	LL
Zone 1	939	1078	1203	1296	1410	1454	1546	1638	1752	1895	2166	2636
Zone 2	953	1094	1221	1315	1431	1476	1569	1663	1778	1923	2198	2676
Zone 3	967	1110	1239	1335	1452	1498	1592	1687	1805	1952	2231	2715

- Chrome leg levelers
- Extra-thick, high-density foam cushions
- No-sag sinuous wire spring seat and back suspensions
- Easy bolt-on assembly
- Seat: 21"W x 19"D x 19"H

OPTION	PRICE	CODE
Softer Seat Foam-Chair	16.00	SF

### QS

## 5914MET Right Arm Unit, Ships with Arm/Seat Assembled

26.5" W X 29" D X 32.5" H

St. Yardage: 4.75

Seat & Back Ydg: 3

Arms Ydg: 1.75

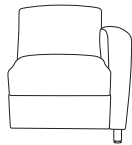

FREIGHT CLASS: 175  
CUBIC FT: 28  
SHIP WEIGHT: 56

Grade	1	2	3	4	5	6	7	8	9	10	L	LL
Zone 1	939	1078	1203	1296	1410	1454	1546	1638	1752	1895	2166	2636
Zone 2	953	1094	1221	1315	1431	1476	1569	1663	1778	1923	2198	2676
Zone 3	967	1110	1239	1335	1452	1498	1592	1687	1805	1952	2231	2715

- Chrome leg levelers
- Extra-thick, high-density foam cushions
- No-sag sinuous wire spring seat and back suspensions
- Easy bolt-on assembly
- Seat: 21"W x 19"D x 19"H

OPTION	PRICE	CODE
Softer Seat Foam-Chair	16.00	SF
Seat & Back Ydg: 3.5	Arms Ydg: 1.75	

### QS

ALL FOAM & FABRICS USED ARE CAL 117 APPROVED

**QS** indicates a Quickship item if ordered in Quickship upholstery. Quick Ship is not available on any item ordered with options.

# 7300/7400 MODULAR SIN VARIOUS

FINISH SELECTION  
NATURAL MAPLE FM | GREY G | WINDSOR CHERRY WC |

CONTEMPORARY

## Create Your Own Space

With the 7300/7400 Modular Collection, create unique configurations, adapt to building layouts and maximize seating capacity. Choose from 12 seating/table components. Approach benches (7300 Series) from either side in open areas. Units with backs (7400 Series) provide full-comfort seating. Freestanding and ganging tables are available in various shapes and sizes.



7300/7400 ganged configuration

## 7300/7400 Details

- High pressure laminate bases and tables
- Black recessed plinth base
- Freestanding & ganging tables
- Replaceable cushions

## Custom Laminate Program

Any Wilsonart® laminate from the **Design Group 1™** program (type 335 grade laminate) is available at an upcharge per unit.

Upcharge is specified in each item description. Please specify the Wilsonart® laminate color when ordering.

### Customer's Own Laminate Program:

You may supply your own laminate at the listed upcharges. Please provide the exact quantity for each model number. The laminate manufacturer, color number, and grade must be provided also. We reserve the right to reject any laminate that does **not meet our manufacturing requirements**.

(\* Laminate requirements based on solid-color, non-directional design per single unit. For any laminate with pattern and/or multiple units, contact Customer Service for specific requirements.

These options **not available on Quick Ship** or regular lead time. Please call Customer Support for delivery dates.

## 7300/7400 Modular

### 7301 Reception Bench

25" W X 28.5" D X 19.5" H

St. Yardage: 1.5

SIN #711-17

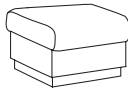

FREIGHT CLASS: 175  
CUBIC FT: 15  
SHIP WEIGHT: 48

QS

Grade	1	2	3	4	5	6	7	8	9	10	L	LL
Zone 1	682	741	792	818	861	878	916	948	992	1046	1149	1363
Zone 2	692	752	804	830	874	891	930	962	1007	1062	1166	1383
Zone 3	702	763	816	843	887	904	943	976	1022	1077	1183	1404

- One seat upholstered bench
- Approachable from either side
- Freestanding or connect to other units
- See features in series overview
- Seat: 24"W x 28"D x 19.5"H

OPTION	PRICE	CODE
Softer Seat Foam-Chair	16.00	SF
Custom Laminate 1-Seat	117.00	S

### 7302 Reception Bench

50" W X 28.5" D X 19.5" H

St. Yardage: 3

SIN #711-17



FREIGHT CLASS: 175  
CUBIC FT: 37  
SHIP WEIGHT: 90

QS

Grade	1	2	3	4	5	6	7	8	9	10	L	LL
Zone 1	1141	1247	1340	1365	1396	1477	1509	1640	1722	1824	2017	2418
Zone 2	1158	1266	1360	1385	1417	1499	1532	1665	1748	1851	2047	2454
Zone 3	1175	1284	1380	1406	1438	1521	1554	1689	1774	1879	2078	2491

- Two seat upholstered bench
- Approachable from either side
- Freestanding or connect to other units
- See features in series overview
- Seat: 48"W x 28"D x 19.5"H

OPTION	PRICE	CODE
Softer Seat Foam-Loveseat	32.00	SF
Custom Laminate 2-Seat	133.00	S

### 7303 Reception Bench

74" W X 28.5" D X 19.5" H

St. Yardage: 4.5

SIN #711-17

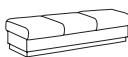

FREIGHT CLASS: 175  
CUBIC FT: 40  
SHIP WEIGHT: 122

QS

Grade	1	2	3	4	5	6	7	8	9	10	L	LL
Zone 1	1715	1874	2017	2106	2231	2279	2481	2606	2762	2921	3159	3660
Zone 2	1741	1902	2047	2138	2264	2313	2518	2645	2803	2965	3206	3715
Zone 3	1766	1930	2078	2169	2298	2347	2555	2684	2845	3009	3254	3770

- Three seat upholstered bench
- Approachable from either side
- Freestanding or connect to other units
- See features in series overview
- Seat: 74"W x 28"D x 19.5"H

OPTION	PRICE	CODE
Softer Seat Foam-Sofa	48.00	SF
Custom Laminate 3-Seat	149.00	S



**7401 Chair**



FREIGHT CLASS: 175  
CUBIC FT: 15  
SHIP WEIGHT: 56

**QS**

25" W X 28.5" D X 30" H

St. Yardage: 2

SIN #711-17

Grade	1	2	3	4	5	6	7	8	9	10	L	LL
Zone 1	811	883	944	981	1035	1056	1103	1144	1198	1266	1395	1664
Zone 2	823	896	958	996	1051	1072	1120	1161	1216	1285	1416	1689
Zone 3	835	909	972	1010	1066	1088	1136	1178	1234	1304	1437	1714

- Freestanding or connect to other seating units or tables
- See features in series overview
- Seat: 25"W x 21"D x 19.5"H

OPTION	PRICE	CODE
Softer Seat Foam-Chair	16.00	SF
Custom Laminate 1-Seat	117.00	S

**7402 Loveseat**



FREIGHT CLASS: 175  
CUBIC FT: 37  
SHIP WEIGHT: 98

**QS**

50" W X 28.5" D X 30" H

St. Yardage: 4

SIN #711-17

Grade	1	2	3	4	5	6	7	8	9	10	L	LL
Zone 1	1363	1501	1631	1703	1811	1853	1902	2029	2137	2273	3055	3243
Zone 2	1383	1524	1655	1729	1838	1881	1931	2059	2169	2307	3101	3292
Zone 3	1404	1546	1680	1754	1865	1909	1959	2090	2201	2341	3147	3340

- Freestanding or connect to other seating units or tables
- See features in series overview
- Seat: 50"W x 21"D x 19.5"H

OPTION	PRICE	CODE
Softer Seat Foam-Loveseat	32.00	SF
Custom Laminate 2-Seat	133.00	S

**7403 Sofa**

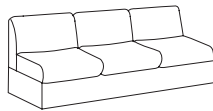

FREIGHT CLASS: 175  
CUBIC FT: 40  
SHIP WEIGHT: 130

**QS**

74" W X 28.5" D X 30" H

St. Yardage: 6

SIN #711-17

Grade	1	2	3	4	5	6	7	8	9	10	L	LL
Zone 1	2007	2226	2413	2517	2680	2743	2809	3006	3169	3372	4556	4677
Zone 2	2037	2259	2449	2555	2720	2784	2851	3051	3217	3423	4624	4747
Zone 3	2067	2293	2485	2593	2760	2825	2893	3096	3264	3473	4693	4817

- Freestanding or connect to other seating units or tables
- See features in series overview
- Seat: 74"W x 21"D x 19.5"H

OPTION	PRICE	CODE
Softer Seat Foam-Sofa	48.00	SF
Custom Laminate 3-Seat	149.00	S

**7420 Coffee Table**

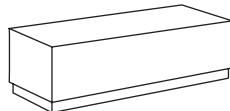

**QS**

- Freestanding
- High pressure laminate top and sides in Grey, Windsor Cherry (WC) or Natural Maple (FM)
- Black recessed plinth base with a textured vinyl surface

FREIGHT CLASS: 150

Zone Pricing					
	1	2	3		
52"W X 20"D X 14"H	Cubic Ft: 16	Ship Weight: 79	<b>825</b>	<b>837</b>	<b>850</b>

OPTION	PRICE	CODE
Custom Laminate 7420	133.00	S

SIN #711-11

**7421 Cylinder Table**

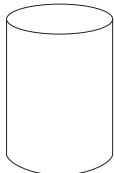

**QS**

- Freestanding
- High pressure laminate top and sides in Grey, Windsor Cherry WC or Natural Maple FM

FREIGHT CLASS: 150

19"W X 19"D X 14"H	Cubic Ft: 6	Ship Weight: 29	<b>663</b>	<b>673</b>	<b>683</b>
--------------------	-------------	-----------------	------------	------------	------------

OPTION	PRICE	CODE
Custom Laminate 7421	133.00	S

SIN #711-11

**7423 End Table**

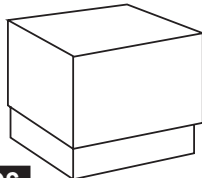

**QS**

- Freestanding
- High pressure laminate top and sides in Grey, Windsor Cherry WC or Natural Maple FM
- Black recessed plinth base

FREIGHT CLASS: 150

25"W X 25"D X 14"H	Cubic Ft: 10	Ship Weight: 54	<b>716</b>	<b>727</b>	<b>737</b>
--------------------	--------------	-----------------	------------	------------	------------

OPTION	PRICE	CODE
Custom Laminate 7423	133.00	S

SIN #711-11

ALL FOAM & FABRICS USED ARE CAL 117 APPROVED

**QS** indicates a Quickship item if ordered in Quickship upholstery. Quick Ship is not available on any item ordered with options.

# 7300/7400 MODULAR SIN VARIOUS

FINISH SELECTION  
 NATURAL MAPLE **FM** | GREY **G** | WINDSOR CHERRY **WC** |

CONTEMPORARY

## 7424 Connector Table

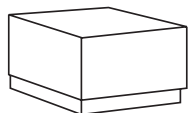

- Freestanding or connect to other units
- High pressure laminate top and sides in Grey, Windsor Cherry WC or Natural Maple FM
- Black recessed plinth base

FREIGHT CLASS: 150

**QS**

## 7425 45° Wedge Table

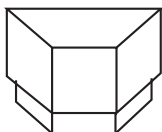

- 45° shape
- Connect to other units to form curves in layout
- High pressure laminate top and sides in Grey, Windsor Cherry WC or Natural Maple FM
- Black recessed plinth base

FREIGHT CLASS: 150

**QS**

## 7426 90° Corner Table

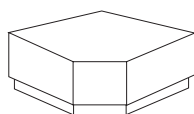

- Freestanding or connect to other units
- High pressure laminate top and sides in Grey, Windsor Cherry WC or Natural Maple FM
- Black recessed plinth base

FREIGHT CLASS: 150

**QS**

## 74A Ganging Kit



- 74A - Joins 7301, 7302, 7303, 7401, 7402, 7403, 7424
- Kit includes ganging plate and 8 screws

FREIGHT CLASS: 70

**QS**

## 74B Ganging Kit



- 74B - Joins 7425 Wedge Table
- Kit includes ganging plate and 8 screws

FREIGHT CLASS: 70

**QS**

## 74C Ganging Kit



- 74C - Joins 7426 Corner Table
- Kit includes ganging plate and 8 screws

FREIGHT CLASS: 70

**QS**

		Zone Pricing		
		1	2	3
18"W X 25"D X 11.5"H	Cubic Ft: 6 Ship Weight: 38	<b>644</b>	<b>654</b>	<b>663</b>
<b>OPTION</b>			<b>PRICE</b>	<b>CODE</b>
Custom Laminate 7424			133.00	S
<b>SIN #711-11</b>				
<hr/>				
8"W Front 27" Back X 25"D X 11.5"H	Cubic Ft: 6 Ship Weight: 38	<b>800</b>	<b>812</b>	<b>824</b>
<b>OPTION</b>			<b>PRICE</b>	<b>CODE</b>
Custom Laminate 7424			133.00	S
<b>SIN #711-11</b>				
<hr/>				
38"W X 38"D X 11.5"H	Cubic Ft: 16 Ship Weight: 80	<b>906</b>	<b>920</b>	<b>933</b>
<b>OPTION</b>			<b>PRICE</b>	<b>CODE</b>
Custom Laminate 7424			133.00	S
<b>SIN #711-11</b>				
<hr/>				
10"W X 3"D X .065"H	Cubic Ft: .2 Ship Weight: .5	<b>29</b>	<b>29</b>	<b>30</b>
<b>SIN #711-17</b>				
<hr/>				
3.5"W X 3"D X .38"H	Cubic Ft: .2 Ship Weight: .5	<b>29</b>	<b>29</b>	<b>30</b>
<b>SIN #711-17</b>				
<hr/>				
3.5"W X 3"D X .75"H	Cubic Ft: .2 Ship Weight: .5	<b>29</b>	<b>29</b>	<b>30</b>
<b>SIN #711-17</b>				

**Our Most Versatile Modular Collection**

**Steps Modular** lounge seating components can be configured, expanded and reconfigured as your business grows and changes. Every component is a seating module, ensuring maximum seating capacity and optimum space-efficiency in your facilities.

Plus, seat/back modules are field replaceable, offering renewability down the road.

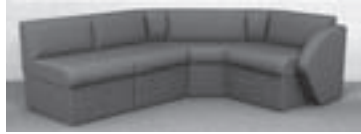

Steps Modular configuration

**Steps Modular Details**

- Full-to-the-Floor bases with radius corners
- All Steps units are available with left or right (facing) arms.
- All units are shipped with metal fasteners pre-bored into the seat frames (nuts and bolts supplied).



7436 90° Corner Unit with upholstered base

**Upholstered Base or Black Finish Base**

- Full-to-the-Floor bases are available fully upholstered.
- Even more modest in price, Steps-Black-Base models feature radius corners, sensitive to waiting areas where children may frequent. Black, textured finish helps limit wear.

**90° Corner Unit**

The 90° Corner Unit can connect with seat modules on either side. Diagonal front increases leg room; diagonal back enhances lumbar support and comfort. In corner applications, the open area behind the unit can accommodate a lamp, plant, etc.

**STEPS Upholstered Base Modular**

**7431 One-Seat Module**

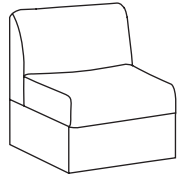

FREIGHT CLASS: 175  
CUBIC FT: 16  
SHIP WEIGHT: 57

**QS**

25" W X 28.5" D X 29.5" H St. Yardage: 3.5

Grade	1	2	3	4	5	6	7	8	9	10	L	LL
Zone 1	811	898	981	1023	1090	1179	1213	1357	1446	1557	1884	2171
Zone 2	823	911	996	1038	1106	1197	1231	1377	1468	1580	1912	2204
Zone 3	835	925	1010	1054	1123	1214	1249	1398	1489	1604	1941	2236

- Fully upholstered
- Freestanding or connect to other units
- See features above
- Seat: 24"W x 21"D x 19.5"H

OPTION	PRICE	CODE
Softer Seat Foam-Chair	16.00	SF

**7432 Two-Seat Module**

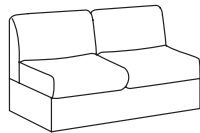

FREIGHT CLASS: 175  
CUBIC FT: 37  
SHIP WEIGHT: 102

**QS**

50" W X 28.5" D X 29.5" H St. Yardage: 6

Grade	1	2	3	4	5	6	7	8	9	10	L	LL
Zone 1	1363	1489	1621	1686	1788	1923	1976	2195	2331	2501	2999	3488
Zone 2	1383	1511	1645	1711	1815	1952	2006	2228	2366	2539	3044	3540
Zone 3	1404	1534	1670	1737	1842	1981	2035	2261	2401	2576	3089	3593

- Fully upholstered
- Freestanding or connect to other units
- See features above
- Seat: 50"W x 21"D x 19.5"H

OPTION	PRICE	CODE
Softer Seat Foam-Loveseat	32.00	SF

**7433 Three-Seat Module**

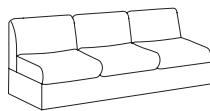

FREIGHT CLASS: 175  
CUBIC FT: 39  
SHIP WEIGHT: 137

**QS**

74" W X 28.5" D X 29.5" H St. Yardage: 8

Grade	1	2	3	4	5	6	7	8	9	10	L	LL
Zone 1	2007	2203	2393	2492	2646	2850	2929	3259	3463	3718	4466	4953
Zone 2	2037	2236	2429	2529	2686	2893	2973	3308	3515	3774	4533	5027
Zone 3	2067	2269	2465	2567	2725	2936	3017	3357	3567	3830	4600	5102

- Fully upholstered
- Freestanding or connect to other units
- See features above
- Seat: 74"W x 21"D x 19.5"H

OPTION	PRICE	CODE
Softer Seat Foam-Sofa	48.00	SF

**7434 Inverted 45° Wedge Module**

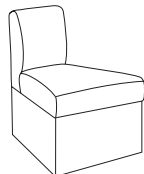

FREIGHT CLASS: 175  
CUBIC FT: 15  
SHIP WEIGHT: 54

**QS**

27.5" W X 25.75" D X 29.5" H St. Yardage: 3.25

Grade	1	2	3	4	5	6	7	8	9	10	L	LL
Zone 1	811	898	981	1023	1090	1179	1213	1357	1446	1557	1884	2171
Zone 2	823	911	996	1038	1106	1197	1231	1377	1468	1580	1912	2204
Zone 3	835	925	1010	1054	1123	1214	1249	1398	1489	1604	1941	2236

- 45° shape, outside facing
- Fully upholstered
- Connect to other units to form curves in layout
- See features above
- Seat: 12.5-27.5"W x 21"D x 19.5"H

OPTION	PRICE	CODE
Softer Seat Foam-Chair	16.00	SF

ALL FOAM & FABRICS USED ARE CAL 117 APPROVED

**QS** indicates a Quickship item if ordered in Quickship upholstery. Quick Ship is not available on any item ordered with options.

### 7435 45° Wedge Seat Module

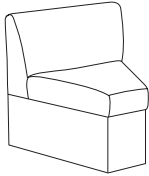

FREIGHT CLASS: 175  
CUBIC FT: 15  
SHIP WEIGHT: 54

**QS**

27.5" W X 25.75" D X 29.5" H St. Yardage: 3.75

Grade	1	2	3	4	5	6	7	8	9	10	L	LL
Zone 1	811	898	981	1023	1090	1179	1213	1357	1446	1557	1884	2171
Zone 2	823	911	996	1038	1106	1197	1231	1377	1468	1580	1912	2204
Zone 3	835	925	1010	1054	1123	1214	1249	1398	1489	1604	1941	2236

- 45° shape, inside facing
- Fully upholstered
- Connect to other units to form curves in layout
- See features in series overview
- Seat: 8-23"W x 21"D x 19.5"H

OPTION	PRICE	CODE
Softer Seat Foam-Chair	16.00	SF

### 7436 90° Corner Seat Module

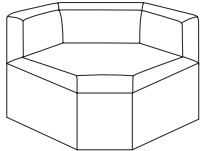

FREIGHT CLASS: 175  
CUBIC FT: 35  
SHIP WEIGHT: 91

**QS**

38" W X 38" D X 29.5" H St. Yardage: 5.5

Grade	1	2	3	4	5	6	7	8	9	10	L	LL
Zone 1	1687	1820	1955	2020	2112	2247	2300	2519	2655	2825	3388	3612
Zone 2	1712	1847	1984	2050	2144	2281	2335	2557	2695	2867	3439	3666
Zone 3	1738	1875	2014	2081	2175	2314	2369	2595	2735	2910	3490	3720

- 90° application (corners)
- 6-sided shape
- Fully upholstered
- Freestanding or connect to other units
- See features in series overview
- Seat: 34"W x 34"D x 19.5"H

OPTION	PRICE	CODE
Softer Seat Foam-Loveseat	32.00	SF

### 7339L Modular Left Arm

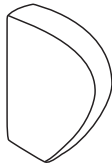

FREIGHT CLASS: 175  
CUBIC FT: 6  
SHIP WEIGHT: 17

**QS**

4.5" W X 23.5" D X 27" H St. Yardage: 2

Grade	1	2	3	4	5	6	7	8	9	10	L	LL
Zone 1	206	251	293	325	363	379	439	477	525	615	761	829
Zone 2	209	255	297	330	368	385	446	484	533	624	772	841
Zone 3	212	259	302	335	374	390	452	491	541	633	784	854

- Fully upholstered arm
- Connects to left side (facing) of any Steps Modular seat

### 7339R Modular Right Arm



FREIGHT CLASS: 175  
CUBIC FT: 6  
SHIP WEIGHT: 17

**QS**

4.5" W X 23.5" D X 27" H St. Yardage: 2

Grade	1	2	3	4	5	6	7	8	9	10	L	LL
Zone 1	206	251	293	325	363	379	439	477	525	615	761	829
Zone 2	209	255	297	330	368	385	446	484	533	624	772	841
Zone 3	212	259	302	335	374	390	452	491	541	633	784	854

- Fully upholstered arm
- Connects to right side (facing) of any Steps Modular seat

### 7331 Square Bench Module

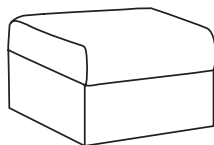

FREIGHT CLASS: 175  
CUBIC FT: 15  
SHIP WEIGHT: 48

**QS**

24" W X 28.5" D X 19.5" H St. Yardage: 3

Grade	1	2	3	4	5	6	7	8	9	10	L	LL
Zone 1	709	798	886	905	941	975	997	1019	1046	1073	1421	1826
Zone 2	720	810	899	919	955	990	1012	1034	1062	1089	1442	1853
Zone 3	730	822	913	932	969	1004	1027	1050	1077	1105	1464	1881

- One-seat fully upholstered bench
- Approachable from either side
- Freestanding or connect to other units
- See features in series overview
- Seat: 24"W x 28"D x 19.5"H

OPTION	PRICE	CODE
Softer Seat Foam-Chair	16.00	SF

### 7335 45° Wedge Bench Module

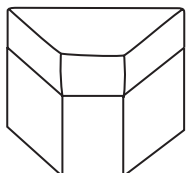

FREIGHT CLASS: 175  
CUBIC FT: 15  
SHIP WEIGHT: 45

**QS**

27.5" W X 25.75" D X 19.5" H St. Yardage: 3

Grade	1	2	3	4	5	6	7	8	9	10	L	LL
Zone 1	709	798	886	905	941	975	997	1019	1046	1073	1421	1826
Zone 2	720	810	899	919	955	990	1012	1034	1062	1089	1442	1853
Zone 3	730	822	913	932	969	1004	1027	1050	1077	1105	1464	1881

- 45° shape
- Fully upholstered
- Connect to other units to form curves in layout
- See features in series overview
- Seat: 8-27.5"W x 25.5"D x 19.5"H

OPTION	PRICE	CODE
Softer Seat Foam-Chair	16.00	SF

**STEPS Upholstered Base Assembled**

**7441 Lounge Chair**

34" W X 28.5" D X 29.5" H St. Yardage: 6.5

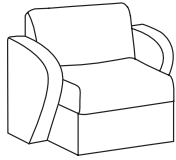

FREIGHT CLASS: 175  
CUBIC FT: 29  
SHIP WEIGHT: 84

**QS**

Grade	1	2	3	4	5	6	7	8	9	10	L	LL
Zone 1	1091	1218	1344	1401	1499	1629	1679	1890	2020	2183	2693	3027
Zone 2	1107	1236	1364	1422	1521	1653	1704	1918	2050	2216	2733	3072
Zone 3	1124	1255	1384	1443	1544	1678	1729	1947	2081	2248	2774	3118

- Fully upholstered
- Ships fully assembled
- Can be reconfigured

- See features in series overview
- Seat: 25"W x 21"D x 19.5"H

OPTION	PRICE	CODE
Softer Seat Foam-Chair	16.00	SF

**7442 Loveseat**

59" W X 28.5" D X 29.5" H St. Yardage: 8.5

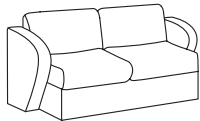

FREIGHT CLASS: 175  
CUBIC FT: 40  
SHIP WEIGHT: 127

**QS**

Grade	1	2	3	4	5	6	7	8	9	10	L	LL
Zone 1	1656	1829	2003	2082	2216	2396	2465	2755	2934	3158	3856	4193
Zone 2	1681	1856	2033	2113	2249	2432	2502	2796	2978	3205	3914	4256
Zone 3	1706	1884	2063	2144	2282	2468	2539	2838	3022	3253	3972	4319

- Fully upholstered
- Ships fully assembled
- Can be reconfigured

- See features in series overview
- Seat: 50"W x 21"D x 19.5"H

OPTION	PRICE	CODE
Softer Seat Foam-Loveseat	32.00	SF

**7443 Sofa**

83" W X 28.5" D X 29.5" H St. Yardage: 11

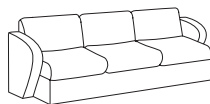

FREIGHT CLASS: 175  
CUBIC FT: 53  
SHIP WEIGHT: 160

**QS**

Grade	1	2	3	4	5	6	7	8	9	10	L	LL
Zone 1	2312	2547	2785	2893	3076	3321	3415	3810	4055	4360	5041	5517
Zone 2	2347	2585	2827	2936	3122	3371	3466	3867	4116	4425	5117	5600
Zone 3	2381	2623	2869	2980	3168	3421	3517	3924	4177	4491	5192	5683

- Fully upholstered
- Ships fully assembled
- Can be reconfigured

- See features in series overview
- Seat: 74"W x 21"D x 19.5"H

OPTION	PRICE	CODE
Softer Seat Foam-Sofa	48.00	SF

**STEPS Black Base Modular**

**7431BLK One-Seat Module**

25" W X 28.5" D X 29.5" H St. Yardage: 2

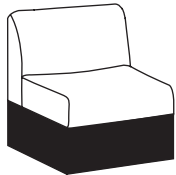

FREIGHT CLASS: 175  
CUBIC FT: 15  
SHIP WEIGHT: 55

**QS**

Grade	1	2	3	4	5	6	7	8	9	10	L	LL
Zone 1	674	724	770	803	844	898	919	1007	1061	1129	1272	1564
Zone 2	684	735	782	815	857	911	933	1022	1077	1146	1291	1587
Zone 3	694	746	793	827	869	925	947	1037	1093	1163	1310	1611

- Black base
- Freestanding or connect to other units

- See features in series overview
- Seat: 25"W x 21"D x 19.5"H

OPTION	PRICE	CODE
Softer Seat Foam-Chair	16.00	SF

**7432BLK Two-Seat Module**

50" W X 28.5" D X 29.5" H St. Yardage: 4



FREIGHT CLASS: 175  
CUBIC FT: 37  
SHIP WEIGHT: 102

**QS**

Grade	1	2	3	4	5	6	7	8	9	10	L	LL
Zone 1	1169	1260	1348	1427	1509	1617	1659	1835	1943	2079	2320	2749
Zone 2	1187	1279	1368	1448	1532	1641	1684	1863	1972	2110	2355	2790
Zone 3	1204	1298	1388	1470	1554	1666	1709	1890	2001	2141	2390	2831

- Black base
- Freestanding or connect to other units

- See features in series overview
- Seat: 50"W x 21"D x 19.5"H

OPTION	PRICE	CODE
Softer Seat Foam-Loveseat	32.00	SF

ALL FOAM & FABRICS USED ARE CAL 117 APPROVED

**QS** indicates a Quickship item if ordered in Quickship upholstery. Quick Ship is not available on any item ordered with options.

### 7433BLK Three-Seat Module

74" W X 28.5" D X 29.5" H St. Yardage: 6

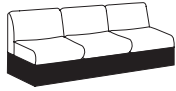

FREIGHT CLASS: 175  
CUBIC FT: 40  
SHIP WEIGHT: 140

**QS**

Grade	1	2	3	4	5	6	7	8	9	10	L	LL
Zone 1	1716	1852	1986	2103	2226	2389	2452	2715	2848	3081	3442	4086
Zone 2	1742	1880	2016	2135	2259	2425	2489	2756	2891	3127	3494	4147
Zone 3	1767	1908	2046	2166	2293	2461	2526	2796	2933	3173	3545	4209

- Black base
- Freestanding or connect to other units
- See features in series overview
- Seat: 74"W x 21"D x 19.5"H

OPTION	PRICE	CODE
Softer Seat Foam-Sofa	48.00	SF

### 7434BLK 45° Inverted-Wedge Module

27.5" W X 25.75" D X 29.5" H St. Yardage: 2

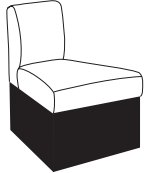

FREIGHT CLASS: 175  
CUBIC FT: 28  
SHIP WEIGHT: 54

**QS**

Grade	1	2	3	4	5	6	7	8	9	10	L	LL
Zone 1	689	737	784	818	859	913	934	1022	1076	1144	1297	1579
Zone 2	699	748	796	830	872	927	948	1037	1092	1161	1316	1603
Zone 3	710	759	808	843	885	940	962	1053	1108	1178	1336	1626

- Black finish base
- 45° shape, outside facing
- Connect to other units to form curves in layout
- See features in series overview
- Seat: 12.5-27.5"W x 21"D x 19.5"H

OPTION	PRICE	CODE
Softer Seat Foam-Chair	16.00	SF

### 7435BLK 45° Inverted-Wedge Module

27.5" W X 25.75" D X 29.5" H St. Yardage: 2.5

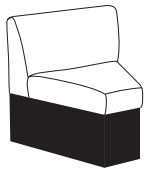

FREIGHT CLASS: 175  
CUBIC FT: 28  
SHIP WEIGHT: 54

**QS**

Grade	1	2	3	4	5	6	7	8	9	10	L	LL
Zone 1	689	737	784	818	859	913	934	1022	1076	1144	1297	1579
Zone 2	699	748	796	830	872	927	948	1037	1092	1161	1316	1603
Zone 3	710	759	808	843	885	940	962	1053	1108	1178	1336	1626

- Black finish base
- 45° shape, inside facing
- Connect to other units to form curves in layout
- See features in series overview
- Seat: 8-23"W x 21"D x 19.5"H

OPTION	PRICE	CODE
Softer Seat Foam-Chair	16.00	SF

### 7436BLK 90° Corner Seat Module

38" W X 38" D X 29.5" H St. Yardage: 4.25

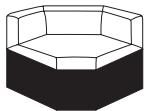

FREIGHT CLASS: 175  
CUBIC FT: 37  
SHIP WEIGHT: 82

**QS**

Grade	1	2	3	4	5	6	7	8	9	10	L	LL
Zone 1	1584	1685	1788	1829	1907	2010	2050	2216	2320	2449	2885	3175
Zone 2	1608	1710	1815	1856	1936	2040	2081	2249	2355	2486	2928	3223
Zone 3	1632	1736	1842	1884	1964	2070	2112	2282	2390	2522	2972	3270

- 90° application (corners)
- 6-sided shape
- Black finish base
- Freestanding or connect to other units
- See features in series overview
- Seat: 34"W x 34"D x 19.5"H

OPTION	PRICE	CODE
Softer Seat Foam-Loveseat	32.00	SF

### 7339L Modular Left Arm

4.5" W X 23.5" D X 27" H St. Yardage: 2

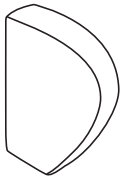

FREIGHT CLASS: 175  
CUBIC FT: 6  
SHIP WEIGHT: 17

**QS**

Grade	1	2	3	4	5	6	7	8	9	10	L	LL
Zone 1	206	251	293	325	363	379	439	477	525	615	761	829
Zone 2	209	255	297	330	368	385	446	484	533	624	772	841
Zone 3	212	259	302	335	374	390	452	491	541	633	784	854

- Fully upholstered arm
- Connects to left side (facing) of any Steps Modular seat



**7339R Modular Right Arm**

4.5" W X 23.5" D X 27" H St. Yardage: 2

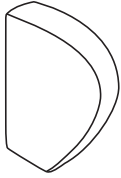

FREIGHT CLASS: 175  
CUBIC FT: 6  
SHIP WEIGHT: 17

**QS**

Grade	1	2	3	4	5	6	7	8	9	10	L	LL
Zone 1	206	251	293	325	363	379	439	477	525	615	761	829
Zone 2	209	255	297	330	368	385	446	484	533	624	772	841
Zone 3	212	259	302	335	374	390	452	491	541	633	784	854

- Fully upholstered arm
- Connects to right side (facing) of any Steps Modular seat

**7331BLK Square Bench Module**

24" W X 28.5" D X 19.5" H St. Yardage: 1.5

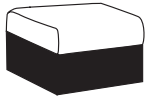

FREIGHT CLASS: 175  
CUBIC FT: 15  
SHIP WEIGHT: 48

**QS**

Grade	1	2	3	4	5	6	7	8	9	10	L	LL
Zone 1	596	641	689	709	742	775	792	862	906	960	1182	1308
Zone 2	605	651	699	720	753	787	804	875	920	974	1200	1328
Zone 3	614	660	710	730	764	798	816	888	933	989	1217	1347

- One-seat bench with black finish base
- Approachable from either side
- Freestanding or connect to other units
- See features in series overview
- Seat: 24"W x 28"D x 19.5"H

OPTION	PRICE	CODE
Softer Seat Foam-Chair	16.00	SF

**7335BLK 45° Wedge Bench Module**

27.5" W X 25.75" D X 19.5" H St. Yardage: 1.75

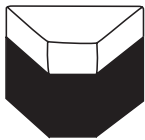

FREIGHT CLASS: 175  
CUBIC FT: 15  
SHIP WEIGHT: 45

**QS**

Grade	1	2	3	4	5	6	7	8	9	10	L	LL
Zone 1	584	630	674	697	720	763	780	850	894	948	1159	1296
Zone 2	593	639	684	707	731	774	792	863	907	962	1176	1315
Zone 3	602	649	694	718	742	786	803	876	921	976	1194	1335

- 45° shape
- Black finish base
- Connect to other units to form curves in layout
- See features in series overview
- Seat: 8-27.5"W x 25.5"D x 19.5"H

OPTION	PRICE	CODE
Softer Seat Foam-Chair	16.00	SF

**STEPS Black Base Assembled**

**7441BLK Lounge Chair**

34" W X 28.5" D X 29.5" H St. Yardage: 5

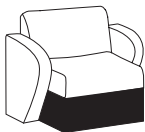

FREIGHT CLASS: 175  
CUBIC FT: 29  
SHIP WEIGHT: 84

**QS**

Grade	1	2	3	4	5	6	7	8	9	10	L	LL
Zone 1	992	1078	1163	1199	1264	1351	1384	1525	1612	1720	2084	2416
Zone 2	1007	1094	1180	1217	1283	1371	1405	1548	1636	1746	2115	2452
Zone 3	1022	1110	1198	1235	1302	1392	1426	1571	1660	1772	2147	2488

- Upholstered seat/back/arms
- Black finish base
- Ships fully assembled
- Can be reconfigured
- See features in series overview
- Seat: 24"W x 21"D x 19.5"H

OPTION	PRICE	CODE
Softer Seat Foam-Chair	16.00	SF

**7442BLK Loveseat**

59" W X 28.5" D X 29.5" H St. Yardage: 6.75



FREIGHT CLASS: 175  
CUBIC FT: 40  
SHIP WEIGHT: 127

**QS**

Grade	1	2	3	4	5	6	7	8	9	10	L	LL
Zone 1	1428	1556	1685	1751	1853	1988	2041	2260	2396	2566	3063	3553
Zone 2	1449	1579	1710	1777	1881	2018	2072	2294	2432	2604	3109	3606
Zone 3	1471	1603	1736	1804	1909	2048	2102	2328	2468	2643	3155	3660

- Upholstered seat/back/arms
- Black finish base
- Ships fully assembled
- Can be reconfigured
- See features in series overview
- Seat: 50"W x 21"D x 19.5"H

OPTION	PRICE	CODE
Softer Seat Foam-Loveseat	32.00	SF

ALL FOAM & FABRICS USED ARE CAL 117 APPROVED

**QS** indicates a Quickship item if ordered in Quickship upholstery. Quick Ship is not available on any item ordered with options.

## 7443BLK Sofa

83" W X 28.5" D X 29.5" H

St. Yardage: 8.5

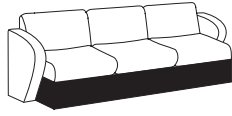

FREIGHT CLASS: 175  
CUBIC FT: 53  
SHIP WEIGHT: 160

**QS**

Grade	1	2	3	4	5	6	7	8	9	10	L	LL
Zone 1	1975	2150	2326	2414	2552	2737	2809	3107	3292	3523	4198	4801
Zone 2	2005	2182	2361	2450	2590	2778	2851	3154	3341	3576	4261	4873
Zone 3	2034	2215	2396	2486	2629	2819	2893	3200	3391	3629	4324	4945

- Upholstered seat/back/arms
- Black finish base
- Ships fully assembled
- Can be reconfigured
- See features in series overview
- Seat: 74"W x 21"D x 19.5"H

OPTION	PRICE	CODE
Softer Seat Foam-Sofa	48.00	SF

## STEPS Black Base Tables

Zone Pricing

1

2

3

### 7420BLK Coffee Table

- Freestanding, multi-use table
- Full-to-floor black texture finish
- Matches Steps-Black Bases



FREIGHT CLASS: 150

**QS**

52"W 20"D X 14"H	Cubic Ft: 16	Ship Weight: 75	<b>673</b>	<b>683</b>	<b>693</b>
------------------	--------------	-----------------	------------	------------	------------

SIN #711-11

### 7423BLK End Table

- Freestanding, multi-use table
- Full-to-floor black texture finish
- Matches Steps-Black Bases

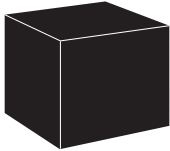

FREIGHT CLASS: 150

**QS**

25"W 25"D X 14"H	Cubic Ft: 10	Ship Weight: 50	<b>550</b>	<b>558</b>	<b>567</b>
------------------	--------------	-----------------	------------	------------	------------

SIN #711-11

### 7424BLK Connecting Table

- Connecting or freestanding table
- Full-to-floor black texture finish
- Matches Steps-Black Bases

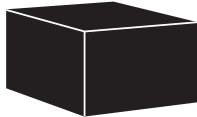

FREIGHT CLASS: 150

**QS**

18"W 25"D X 11.5"H	Cubic Ft: 6	Ship Weight: 36	<b>489</b>	<b>496</b>	<b>504</b>
--------------------	-------------	-----------------	------------	------------	------------

SIN #711-11

### 7425BLK Wedge Table

- 45° shape table
- Connect to other units to form curves in layout
- Full-to-floor black texture finish
- Matches Steps-Black Bases

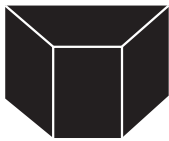

FREIGHT CLASS: 125

**QS**

8' W Front X 27" W Back 25"D X 11.5"H	Cubic Ft: 6	Ship Weight: 37	<b>550</b>	<b>558</b>	<b>567</b>
---------------------------------------	-------------	-----------------	------------	------------	------------

SIN #711-11

### 7426BLK Corner Table

- Connecting or freestanding table
- Full-to-floor black texture finish
- Matches Steps Black bases

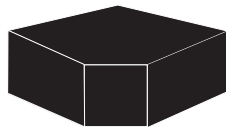

FREIGHT CLASS: 150

**QS**

38"W 38"D X 11.5"H	Cubic Ft: 16	Ship Weight: 77	<b>806</b>	<b>818</b>	<b>830</b>
--------------------	--------------	-----------------	------------	------------	------------

SIN #711-11

**QS**

ALL FOAM & FABRICS USED ARE CAL 117 APPROVED  
indicates a Quickship item if ordered in Quickship upholstery.  
Quick Ship is not available on any item ordered with options.

# FINISH SELECTION

ASPEN AP | BLACK BLK | NATURAL FM | HONEY CHERRY HCY | MAHOGANY MAH | MOAB MOB | PEARWOOD PW | ROUGE MAHOGANY RM | WALNUT WAL | WINDSOR CHERRY WC | CLASSIC CHERRY CCY | ESPRESSO ESP |

SIN 711-16 **SOPHIA**

CONTEMPORARY

## A Gently Curving Profile

The **Sophia** series, with its gently curving profile, offers you the option of ¾ or full height arms. Mix and match the pieces in this collection to create a truly unique space.

## Sophia Details

- Taut seat, no-sag springs
- High density foam adds comfort
- Coordinating cocktail and end table
- Wood finish legs

## Welt Trim Information

- Welt Trim is standard on Models 5201, 5202 & 5203
- Welt Trim is **optional** on Models 5221, 5222 & 5223. Add **\$100** to list price
- Welt available in **Contrasting Welt (CW)** or **Same Welt (SW)**. Please add CW or SW to model number.

5221 Club Chair with ¾ arms



5202 Loveseat with high arms

## STANDARD ORDER: SPECIFICATION DETAIL

<u>5202</u>	<u>CW</u>	<u>MAH</u>	<u>741</u>	<u>952</u>
Base Model	Welt Type <u>CW</u> Contrasting	Wood Finish	Fabric	Welt Fabric (If Contrasting Welt <u>CW</u> was selected)

## Sophia

### 5201 Club Chair with High Arms

30" W X 33" D X 33" H

St. Yardage: 7

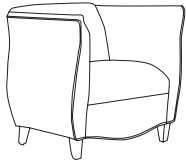

FREIGHT CLASS: 175  
CUBIC FT: 31  
SHIP WEIGHT: 95

QS

Grade	1	2	3	4	5	6	7	8	9	10	L	LL
Zone 1	1458	1569	1680	1768	1866	1996	2046	2257	2387	2550	2969	3494
Zone 2	1480	1593	1705	1795	1894	2026	2077	2291	2423	2588	3014	3546
Zone 3	1502	1616	1730	1821	1922	2056	2107	2325	2459	2627	3058	3599

- Wood legs
- Tight seat over no-sag springs
- High density foam seat and back cushions
- Welt is standard
- Seat: 20"W x 20"D x 19.5"H

OPTION	PRICE	CODE
Contrasting Welt	N/C	CW

### 5202 Loveseat with High Arms

54" W X 33" D X 33" H

St. Yardage: 9

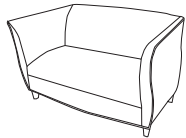

FREIGHT CLASS: 175  
CUBIC FT: 57  
SHIP WEIGHT: 120

QS

Grade	1	2	3	4	5	6	7	8	9	10	L	LL
Zone 1	2098	2241	2384	2485	2608	2771	2834	3097	3260	3463	4043	4668
Zone 2	2129	2275	2420	2522	2647	2813	2877	3143	3309	3515	4104	4738
Zone 3	2161	2308	2456	2560	2686	2854	2919	3190	3358	3567	4164	4808

- Wood legs
- Tight seat over no-sag springs
- High density foam seat and back cushions
- Welt is standard
- Seat: 42.75"W x 20"D x 19.5"H

OPTION	PRICE	CODE
Contrasting Welt	N/C	CW

### 5203 Sofa with High Arms

76" W X 33" D X 33" H

St. Yardage: 10.5

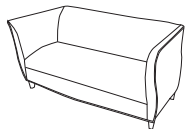

FREIGHT CLASS: 175  
CUBIC FT: 75  
SHIP WEIGHT: 145

QS

Grade	1	2	3	4	5	6	7	8	9	10	L	LL
Zone 1	2680	2859	3037	3183	3342	3554	3636	3978	4190	4455	5111	5951
Zone 2	2720	2902	3083	3231	3392	3607	3691	4038	4253	4522	5188	6040
Zone 3	2760	2945	3128	3278	3442	3661	3745	4097	4316	4589	5264	6130

- Wood legs
- Tight seat over no-sag springs
- High density foam seat and back cushions
- Welt is standard
- Seat: 65"W x 20"D x 19.5"H

OPTION	PRICE	CODE
Contrasting Welt	N/C	CW

ALL FOAM & FABRICS USED ARE CAL 117 APPROVED

QS indicates a Quickship item if ordered in Quickship upholstery. Quick Ship is not available on any item ordered with options.

## FINISH SELECTION

ASPEN **AP** | BLACK **BLK** | NATURAL **FM** | HONEY CHERRY **HCY** | MAHOGANY **MAH** | MOAB **MOB** | PEARWOOD **PW** | ROUGE MAHOGANY **RM** | WALNUT **WAL** | WINDSOR CHERRY **WC** | CLASSIC CHERRY **CCY** | ESPRESSO **ESP** |

CONTEMPORARY

### 5221 Club Chair with Low Arms

30" W X 33" D X 33" H

St. Yardage: 7

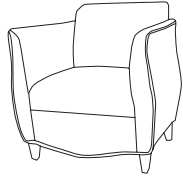

FREIGHT CLASS: 175  
CUBIC FT: 31  
SHIP WEIGHT: 95

**QS**

Grade	1	2	3	4	5	6	7	8	9	10	L	LL
<b>Zone 1</b>	1341	1451	1562	1651	1749	1879	1929	2140	2270	2433	2854	3477
<b>Zone 2</b>	1361	1473	1585	1676	1775	1907	1958	2172	2304	2469	2897	3529
<b>Zone 3</b>	1381	1495	1609	1701	1801	1935	1987	2204	2338	2506	2940	3581

- Wood legs
- Tight seat over no-sag springs
- High density foam seat and back cushions
- No welt standard
- Seat: 20"W x 20"D x 19.5"H

OPTION	PRICE	CODE
Contrasting Welt	100.00	CW
Same Welt	100.00	SW

### 5222 Loveseat with Low Arms

54" W X 33" D X 33" H

St. Yardage: 8.75



FREIGHT CLASS: 175  
CUBIC FT: 57  
SHIP WEIGHT: 120

**QS**

Grade	1	2	3	4	5	6	7	8	9	10	L	LL
<b>Zone 1</b>	1981	2120	2258	2368	2491	2654	2717	2980	3143	3346	3871	4551
<b>Zone 2</b>	2011	2152	2292	2404	2528	2694	2758	3025	3190	3396	3929	4619
<b>Zone 3</b>	2040	2184	2326	2439	2566	2734	2799	3069	3237	3446	3987	4688

- Wood legs
- Tight seat over no-sag springs
- High density foam seat and back cushions
- No welt standard
- Seat: 42.75"W x 20"D x 19.5"H

OPTION	PRICE	CODE
Contrasting Welt	100.00	CW
Same Welt	100.00	SW

### 5223 Sofa with Low Arms

76" W X 33" D X 33" H

St. Yardage: 10.25

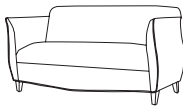

FREIGHT CLASS: 175  
CUBIC FT: 75  
SHIP WEIGHT: 145

**QS**

Grade	1	2	3	4	5	6	7	8	9	10	L	LL
<b>Zone 1</b>	2565	2727	2889	3068	3227	3439	3521	3863	4075	4340	4779	5236
<b>Zone 2</b>	2603	2768	2932	3114	3275	3491	3574	3921	4136	4405	4851	5315
<b>Zone 3</b>	2642	2809	2976	3160	3324	3542	3627	3979	4197	4470	4922	5393

- Wood legs
- Tight seat over no-sag springs
- High density foam seat and back cushions
- No welt standard
- Seat: 65"W x 20"D x 19.5"H

OPTION	PRICE	CODE
Contrasting Welt	100.00	CW
Same Welt	100.00	SW

**Dramatic Curves**

We believe that a seat can, and should, combine both form and function. For **Claudia**, we put special emphasis on the form. Take a seat and your arms will naturally fall into the gently undulating contour of the fully upholstered arms. Brightly polished aluminum legs add just the right amount of sparkle and visual interest.

**Claudia Details**

- *Angled satin finish chrome legs with stationary feet*
- *Taut-upholstery*
- *No-sag sinuous wire spring seat and back suspensions*
- *Coordinating cocktail and end table*

**Two-Color Fabric Combination**

• *Contrasting fabric combinations are available. To order, please add the Seat/Back Fabric code, followed by Arm Fabric code to the model number.*



**5302 Loveseat**



**5301 Chair**

STANDARD ORDER: SPECIFICATION DETAIL

**5302** **326-004** **350-043**

Base Model      Seat/Back Fabric      Arm Fabric, (if different from Seat/Back fabric)

**Two-Color Combinations:** Add upcharge to the highest fabric price grade featured on unit.

CLUB CHAIR ..... \$53 List      SOFA..... \$96 List  
 LOVESEAT ..... \$74 List

**Claudia**

**5301 Club Chair**

33.5" W X 31" D X 32.5" H      St. Yardage: 5.75

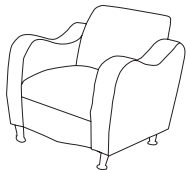

FREIGHT CLASS: 175  
 CUBIC FT: 31  
 SHIP WEIGHT: 90

**QS**

Grade	1	2	3	4	5	6	7	8	9	10	L	LL
Zone 1	1281	1372	1464	1604	1706	1841	1894	2113	2249	2419	2525	2842
Zone 2	1300	1393	1486	1628	1732	1869	1922	2145	2283	2455	2563	2885
Zone 3	1319	1413	1508	1652	1757	1896	1951	2176	2316	2492	2601	2927

- Gently contoured fully upholstered arms
- Angled satin finished chrome legs with stationary feet
- Extra-thick, high-density foam cushions
- Seat: 21"W x 21"D x 19"H

**5302 Loveseat**

56.5" W X 31" D X 32.5" H      St. Yardage: 8

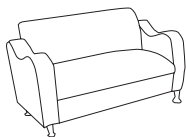

FREIGHT CLASS: 175  
 CUBIC FT: 57  
 SHIP WEIGHT: 125

**QS**

Grade	1	2	3	4	5	6	7	8	9	10	L	LL
Zone 1	1831	1946	2061	2211	2386	2561	2795	2935	3073	3262	3398	4043
Zone 2	1858	1975	2092	2244	2422	2599	2837	2979	3119	3311	3449	4104
Zone 3	1886	2004	2123	2277	2458	2638	2879	3023	3165	3360	3500	4164

- Gently contoured fully upholstered arms
- Angled satin finished chrome legs with stationary feet
- Extra-thick, high-density foam cushions
- Seat: 43.5"W x 21"D x 19"H

**5303 Sofa**

78.5" W X 31" D X 32.5" H      St. Yardage: 10

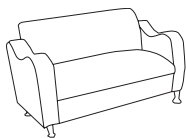

FREIGHT CLASS: 175  
 CUBIC FT: 75  
 SHIP WEIGHT: 165

**QS**

Grade	1	2	3	4	5	6	7	8	9	10	L	LL
Zone 1	2565	2703	2841	3095	3339	3584	3710	4089	4236	4362	4455	5096
Zone 2	2603	2744	2884	3141	3389	3638	3766	4150	4300	4427	4522	5172
Zone 3	2642	2784	2926	3188	3439	3692	3821	4212	4363	4493	4589	5249

- Gently contoured fully upholstered arms
- Angled satin finished chrome legs with stationary feet
- Extra-thick, high-density foam cushions
- Seat: 65.5"W x 21"D x 19"H

ALL FOAM & FABRICS USED ARE CAL 117 APPROVED

**QS** indicates a Quickship item if ordered in Quickship upholstery. Quick Ship is not available on any item ordered with options.

# CLAUDIA

SIN 711-16

CONTEMPORARY

## HW\_CT48 Coffee Table

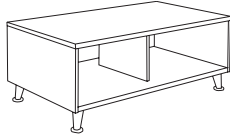

- Open storage/display shelf and top
- Angled satin finish chrome legs with stationary feet to match Claudia series
- Ships fully assembled

FREIGHT CLASS: 150

## HW\_ET18 End Table

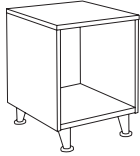

- Open storage/display shelf and top
- Angled satin finish chrome legs with stationary feet to match Claudia series
- Ships fully assembled

FREIGHT CLASS: 150

Zone Pricing

1

2

3

48"W x 24"D x 18"H      Cubic Ft: 11.9      Ship Weight: 96      **681**      **691**      **701**

Finish Options: Natural Maple (FM), Windsor Cherry (WC), Mahogany (M), Graphite (GP), Medium Oak (O), Aspen (AP), Pearwood (PW), Black (E), Espresso (X), Grey (G), Classic Cherry (CC)

SIN #711-11

18"W x 22"D x 24"H      Cubic Ft: 6.5      Ship Weight: 50      **529**      **537**      **545**

Finish Options: Natural Maple (FM), Windsor Cherry (WC), Mahogany (M), Graphite (GP), Medium Oak (O), Aspen (AP), Pearwood (PW), Black (E), Espresso (X), Grey (G), Classic Cherry (CC)

SIN #711-11

CONTEMPORARY



ALL FOAM & FABRICS USED ARE CAL 117 APPROVED

indicates a Quickship item if ordered in Quickship upholstery. Quick Ship is not available on any item ordered with options.



# FINISH SELECTION

ASPEN **AP** | BLACK **BLK** | NATURAL **FM** | HONEY CHERRY **HCY** | MAHOGANY **MAH** | MOAB **MOB** | PEARWOOD **PW** | ROUGE MAHOGANY **RM** | WALNUT **WAL** | WINDSOR CHERRY **WC** | CLASSIC CHERRY **CCY** | ESPRESSO **ESP** |

SIN 711-16 **LAUREN**

CONTEMPORARY

## Art Deco Influences

The **Lauren Collection** of seating and occasional tables blends Art Deco influences with a versatile design applicable from offices to public, waiting room, hospitality and healthcare environments.

## Lauren Details

- *Taut seat, no-sag springs*
  - *High density foam adds comfort*
  - *Stitching between sections of seat and back cushions on loveseat and sofa units only if required by upholstery application, topped vs. railroad.*
  - *Coordinating cocktail and end table*
- Wood finish legs

## Optional BAM Foot Available

- *Truncated BAM foot design increases contact with floor. Recommended for high-use areas.*
- *Available in Black finish only.*
- *Add \$53 upcharge*
- *To specify BAM foot, add **B** to the end of the model number.*



6101 Club Chair



6103 Sofa

## Lauren

### 6101 Club Chair

36" W X 32.5" D X 34" H

St. Yardage: 6.25

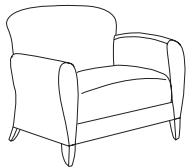

FREIGHT CLASS: 175  
CUBIC FT: 31  
SHIP WEIGHT: 95

**QS**

Grade	1	2	3	4	5	6	7	8	9	10	L	LL
Zone 1	1717	1919	2093	2193	2345	2404	2649	2801	2991	3353	4098	4209
Zone 2	1743	1948	2124	2226	2380	2440	2689	2843	3036	3403	4159	4272
Zone 3	1769	1977	2156	2259	2415	2476	2728	2885	3081	3454	4221	4335

- Wood legs in finishes listed above
- High density foam seat and back cushions
- Tight seat over no-sag springs
- Seat: 22"W x 21.5"D x 19"H

OPTION	PRICE	CODE
Softer Seat Foam-Chair	16.00	SF
Black BAM Feet	53.00	B

### 6102 Loveseat

58" W X 32.5" D X 34" H

St. Yardage: 7.5

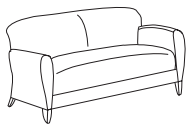

FREIGHT CLASS: 175  
CUBIC FT: 57  
SHIP WEIGHT: 120

**QS**

Grade	1	2	3	4	5	6	7	8	9	10	L	LL
Zone 1	2276	2524	2734	2853	3038	3110	3408	3593	3824	4262	4975	5302
Zone 2	2310	2562	2775	2896	3084	3157	3459	3647	3881	4326	5050	5382
Zone 3	2344	2600	2816	2939	3129	3203	3510	3701	3939	4390	5124	5461

- Wood legs in finishes listed above
- High density foam seat and back cushions
- Tight seat over no-sag springs
- Seat: 45"W x 21.5"D x 19"H

OPTION	PRICE	CODE
Softer Seat Foam-Loveseat	32.00	SF
Black BAM Feet	53.00	B

### 6103 Sofa

80" W X 32.5" D X 34" H

St. Yardage: 10

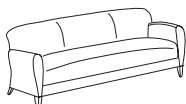

FREIGHT CLASS: 175  
CUBIC FT: 75  
SHIP WEIGHT: 145

**QS**

Grade	1	2	3	4	5	6	7	8	9	10	L	LL
Zone 1	2846	3160	3438	3610	3855	3949	4092	4344	4589	4894	5975	6401
Zone 2	2889	3207	3490	3664	3913	4008	4153	4409	4658	4967	6065	6497
Zone 3	2931	3255	3541	3718	3971	4067	4215	4474	4727	5041	6154	6593

- Wood legs in finishes listed above
- High density foam seat and back cushions
- Tight seat over no-sag springs
- Seat: 67"W x 21.5"D x 19"H

OPTION	PRICE	CODE
Softer Seat Foam-Sofa	48.00	SF
Black BAM Feet	53.00	B

ALL FOAM & FABRICS USED ARE CAL 117 APPROVED

**QS** indicates a Quickship item if ordered in Quickship upholstery. Quick Ship is not available on any item ordered with options.

# REBECCA SIN 711-16

## FINISH SELECTION

ASPEN **AP** | BLACK **BLK** | NATURAL **FM** | HONEY CHERRY **HCY** | MAHOGANY **MAH** | MOAB **MOB** | PEARWOOD **PW** | ROUGE MAHOGANY **RM** | WALNUT **WAL** | WINDSOR CHERRY **WC** | CLASSIC CHERRY **CCY** | ESPRESSO **ESP** |

CONTEMPORARY

### Award Winning

Award-winning reception seating, **Rebecca** features an elegant, flared-arm design popular in many environments and applications.



6201 Club Chair

### Rebecca Details

- Taut seat, no-sag springs
- High density foam adds comfort
- Stitching between sections of seat and back cushions on loveseat and sofa units only if required by upholstery application, topped vs. railroad
- Coordinating cocktail and end table
- Wood finish legs

### Optional BAM Foot Available

- Truncated BAM foot design increases contact with floor. Recommended for high-use areas.
- Available in Black finish only.
- Add \$53 upcharge
- To specify BAM foot, add **B** to the end of the model number.



## Rebecca

### 6201 Club Chair

38" W X 32.5" D X 34.5" H

St. Yardage: 5.75

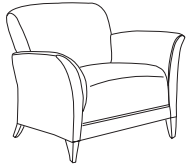

FREIGHT CLASS: 175  
CUBIC FT: 31  
SHIP WEIGHT: 72

QS

Grade	1	2	3	4	5	6	7	8	9	10	L	LL
Zone 1	1717	1919	2093	2193	2345	2404	2649	2801	2991	3353	4098	4209
Zone 2	1743	1948	2124	2226	2380	2440	2689	2843	3036	3403	4159	4272
Zone 3	1769	1977	2156	2259	2415	2476	2728	2885	3081	3454	4221	4335

- Wood legs in finishes listed above
- High density foam seat and back cushions
- Tight seat over no-sag springs
- Seat: 23"W x 22"D x 19"H

OPTION	PRICE	CODE
Softer Seat Foam-Chair	16.00	SF
Black BAM Feet	53.00	B

### 6202 Loveseat

59" W X 32.5" D X 34.5" H

St. Yardage: 7

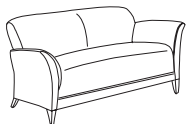

FREIGHT CLASS: 175  
CUBIC FT: 57  
SHIP WEIGHT: 113

QS

Grade	1	2	3	4	5	6	7	8	9	10	L	LL
Zone 1	2276	2524	2734	2853	3038	3110	3408	3593	3824	4262	4975	5302
Zone 2	2310	2562	2775	2896	3084	3157	3459	3647	3881	4326	5050	5382
Zone 3	2344	2600	2816	2939	3129	3203	3510	3701	3939	4390	5124	5461

- Wood legs in finishes listed above
- High density foam seat and back cushions
- Tight seat over no-sag springs
- Seat: 44.25"W x 22"D x 19"H

OPTION	PRICE	CODE
Softer Seat Foam-Loveseat	32.00	SF
Black BAM Feet	53.00	B

### 6203 Sofa

81.5" W X 32.5" D X 34.5" H

St. Yardage: 9.5

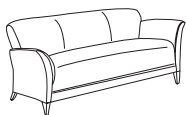

FREIGHT CLASS: 175  
CUBIC FT: 75  
SHIP WEIGHT: 142

QS

Grade	1	2	3	4	5	6	7	8	9	10	L	LL
Zone 1	2846	3160	3438	3610	3855	3949	4092	4344	4589	4894	5975	6401
Zone 2	2889	3207	3490	3664	3913	4008	4153	4409	4658	4967	6065	6497
Zone 3	2931	3255	3541	3718	3971	4067	4215	4474	4727	5041	6154	6593

- Wood legs in finishes listed above
- High density foam seat and back cushions
- Tight seat over no-sag springs
- Seat: 66.5"W x 22"D x 19"H

OPTION	PRICE	CODE
Softer Seat Foam-Sofa	48.00	SF
Black BAM Feet	53.00	B

QS

ALL FOAM & FABRICS USED ARE CAL 117 APPROVED indicates a Quickship item if ordered in Quickship upholstery. Quick Ship is not available on any item ordered with options.

# FINISH SELECTION

ASPEN **AP** | BLACK **BLK** | NATURAL **FM** | HONEY CHERRY **HCY** | ROUGE MAHOGANY **RM** | MAHOGANY **MAH** | MOAB **MOB** | PEARWOOD **PW** | WALNUT **WAL** | WINDSOR CHERRY **WC** | CLASSIC CHERRY **CCY** | ESPRESSO **ESP** |

# SIN 711-16 SCARLET

CONTEMPORARY

## Impressive Seating

From hospitality to healthcare to educational and corporate environments, the **Scarlet Collection** presents a distinctive scroll-arm design, creating impressive lounges, lobbies and other sitting areas.



6301 Club Chair

## Scarlet Details

- *Taut seat, no-sag springs*
- *High density foam adds comfort*
- *Stitching between sections of seat and back cushions on loveseat and sofa units only if required by upholstery application, topped vs. railroad*
- *Coordinating cocktail and end table*
- *Wood finish legs*



## Optional BAM Foot Available

- *Truncated BAM foot design increases contact with floor. Recommended for high-use areas.*
- *Available in Black finish only.*
- *Add \$53 upcharge*
- *To specify BAM foot, add **B** to the end of the model number.*



## Scarlet

### 6301 Club Chair

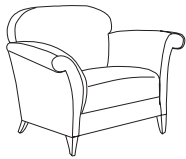

FREIGHT CLASS: 175  
CUBIC FT: 31  
SHIP WEIGHT: 95

**QS**

38" W X 32.5" D X 34.5" H St. Yardage: 6.5

Grade	1	2	3	4	5	6	7	8	9	10	L	LL
Zone 1	1895	2102	2287	2405	2568	2631	2894	3157	3360	3684	3948	4447
Zone 2	1923	2134	2321	2441	2607	2670	2937	3204	3410	3739	4007	4514
Zone 3	1952	2165	2356	2477	2645	2710	2981	3252	3461	3795	4066	4580

- Wood legs in finishes listed above
- Tight seat over no-sag springs
- High density foam seat and back cushions
- Scroll arm and box welted back design
- Seat: 21"W x 22"D x 19"H

OPTION	PRICE	CODE
Softer Seat Foam-Chair	16.00	SF
Black BAM Feet	53.00	B

### 6302 Loveseat

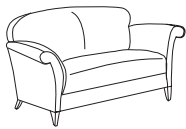

FREIGHT CLASS: 175  
CUBIC FT: 57  
SHIP WEIGHT: 120

**QS**

59" W X 32.5" D X 34.5" H St. Yardage: 8

Grade	1	2	3	4	5	6	7	8	9	10	L	LL
Zone 1	2498	2756	2975	3092	3283	3356	3663	3853	4091	4343	5274	5613
Zone 2	2535	2797	3020	3138	3332	3406	3718	3911	4152	4408	5353	5697
Zone 3	2573	2839	3064	3185	3381	3457	3773	3969	4214	4473	5432	5781

- Wood legs in finishes listed above
- Tight seat over no-sag springs
- High density foam seat and back cushions
- Scroll arm and box welted back design
- Seat: 44"W x 22"D x 19"H

OPTION	PRICE	CODE
Softer Seat Foam-Loveseat	32.00	SF
Black BAM Feet	53.00	B

### 6303 Sofa

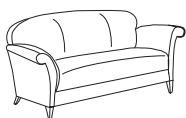

FREIGHT CLASS: 175  
CUBIC FT: 75  
SHIP WEIGHT: 145

**QS**

81" W X 32.5" D X 34.5" H St. Yardage: 10.5

Grade	1	2	3	4	5	6	7	8	9	10	L	LL
Zone 1	3126	3443	3724	3890	4135	4229	4381	4624	4869	5174	5755	6707
Zone 2	3173	3495	3780	3948	4197	4292	4447	4693	4942	5252	5841	6808
Zone 3	3220	3546	3836	4007	4259	4356	4512	4763	5015	5329	5928	6908

- Wood legs in finishes listed above
- Tight seat over no-sag springs
- High density foam seat and back cushions
- Scroll arm and box welted back design
- Seat: 66.5"W x 22"D x 19"H

OPTION	PRICE	CODE
Softer Seat Foam-Sofa	48.00	SF
Black BAM Feet	53.00	B

ALL FOAM & FABRICS USED ARE CAL 117 APPROVED

**QS** indicates a Quickship item if ordered in Quickship upholstery. Quick Ship is not available on any item ordered with options.

### Sophisticated Form

**Kimberly Collection** blends sophisticated form with careful attention to details, such as soft arm pleats and welted design lines, for an elegant, fully upholstered reception seating solution that includes occasional tables.



6401 Club Chair

### Kimberly Details

- *Taut seat, no-sag springs*
- *High density foam adds comfort*
- *Stitching between sections of seat and back cushions on loveseat and sofa units only if required by upholstery application, topped vs. railroad*
- *Coordinating cocktail and end table*
- *Wood finish legs*



### Optional BAM Foot Available

- *Truncated BAM foot design increases contact with floor. Recommended for high-use areas.*
- *Available in Black finish only.*
- *Add \$53 upcharge*
- *To specify BAM foot, add **B** to the end of the model number.*



## Kimberly

### 6401 Club Chair

37.5" W X 32.5" D X 35" H

St. Yardage: 6.25

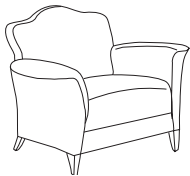

FREIGHT CLASS: 175  
CUBIC FT: 31  
SHIP WEIGHT: 95

**QS**

Grade	1	2	3	4	5	6	7	8	9	10	L	LL
Zone 1	1895	2102	2287	2405	2568	2631	2894	3157	3360	3684	3948	4447
Zone 2	1923	2134	2321	2441	2607	2670	2937	3204	3410	3739	4007	4514
Zone 3	1952	2165	2356	2477	2645	2710	2981	3252	3461	3795	4066	4580

- Wood legs in finishes listed above
- Flared welted arm design
- Camel style welted back
- Seat: 22.5"W x 22"D x 19"H

SIN #711-16

OPTION	PRICE	CODE
Softer Seat Foam-Chair	16.00	SF
Black BAM Feet	53.00	B

### 6402 Loveseat

58" W X 32.5" D X 35" H

St. Yardage: 8

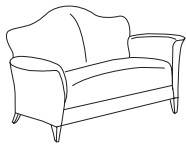

FREIGHT CLASS: 175  
CUBIC FT: 57  
SHIP WEIGHT: 120

**QS**

Grade	1	2	3	4	5	6	7	8	9	10	L	LL
Zone 1	2498	2756	2975	3092	3283	3356	3663	3853	4091	4343	5274	5613
Zone 2	2535	2797	3020	3138	3332	3406	3718	3911	4152	4408	5353	5697
Zone 3	2573	2839	3064	3185	3381	3457	3773	3969	4214	4473	5432	5781

- Wood legs in finishes listed above
- Flared welted arm design
- Camel style welted back
- Seat: 43.5"W x 22"D x 19"H

SIN #711-16

OPTION	PRICE	CODE
Softer Seat Foam-Loveseat	32.00	SF
Black BAM Feet	53.00	B

### 6403 Sofa

81" W X 32.5" D X 35" H

St. Yardage: 10



FREIGHT CLASS: 175  
CUBIC FT: 75  
SHIP WEIGHT: 145

**QS**

Grade	1	2	3	4	5	6	7	8	9	10	L	LL
Zone 1	3126	3443	3724	3890	4135	4229	4381	4624	4869	5174	5755	6707
Zone 2	3173	3495	3780	3948	4197	4292	4447	4693	4942	5252	5841	6808
Zone 3	3220	3546	3836	4007	4259	4356	4512	4763	5015	5329	5928	6908

- Wood legs in finishes listed above
- Flared welted arm design
- Camel style welted back
- Seat: 67"W x 22"D x 19"H

SIN #711-16

OPTION	PRICE	CODE
Softer Seat Foam-Sofa	48.00	SF
Black BAM Feet	53.00	B

**QS**

ALL FOAM & FABRICS USED ARE CAL 117 APPROVED  
indicates a Quickship item if ordered in Quickship upholstery.  
Quick Ship is not available on any item ordered with options.

# FINISH SELECTION

ASPEN **AP** | BLACK **BLK** | NATURAL **FM** | HONEY CHERRY **HCY** | ROUGE  
 MAHOGANY **RM** | MAHOGANY **MAH** | MOAB **MOB** | PEARWOOD **PW** | WALNUT  
 WAL | WINDSOR CHERRY **WC** | CLASSIC CHERRY **CCY** | ESPRESSO **ESP** |

SIN VARIOUS **KIMBERLY**

## 6400 Ottoman

31" W X 20.5" D X 17.5" H

St. Yardage: 2.5

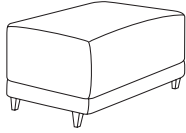

FREIGHT CLASS: 150  
 CUBIC FT: 15  
 SHIP WEIGHT: 42

Grade	1	2	3	4	5	6	7	8	9	10	L	LL
<b>Zone 1</b>	650	726	788	820	845	874	895	983	1037	1105	1234	1531
<b>Zone 2</b>	660	737	800	832	858	887	908	998	1053	1122	1253	1554
<b>Zone 3</b>	670	748	812	845	870	900	922	1012	1068	1138	1271	1577

- Wood legs
- High density foam

SIN #711-16

OPTION	PRICE	CODE
Self-Locking Casters	85.00	S
Softer Seat Foam-Chair	16.00	SF
Black BAM Feet	53.00	B
Accompany Metal Legs	90.00	MET

**QS**

## 6720 Cocktail Table, Wood Veneer Top

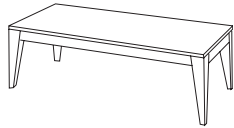

- Solid hardwood legs
- Veneer top
- Available in all seating finishes
- Assembly required

FREIGHT CLASS: 85

	Zone Pricing	1	2	3
54"W x 24"D x 16"H    Cubic Ft: 5    Ship Weight: 55		1034	1050	1065

SIN #711-11

**QS**

## 6723 End Table, Wood Veneer Top



- Solid hardwood legs
- Veneer top
- Available in all seating finishes
- Assembly required

FREIGHT CLASS: 85

24"W x 28"D x 20"H    Cubic Ft: 3    Ship Weight: 40		768	780	791
--	--	-----	-----	-----

SIN #711-11

**QS**

CONTEMPORARY

ALL FOAM & FABRICS USED ARE CAL 117 APPROVED

**QS** indicates a Quickship item if ordered in Quickship upholstery.  
 Quick Ship is not available on any item ordered with options.

# CASSY/NATALIE SIN 711-16

CONTEMPORARY

## Smart Size, Long-term Comfort

Cassy & Natalie feature low-to-the-floor design and smart sizing for a multitude of applications. Chair, loveseat and sofa are fully upholstered and include high-density foam for long-term comfort and durability. All are taut-upholstered with fixed seat/back for elegant appearance.

## Cassy Features

- Modern style
- Upward sloping arms with double-needle(baseball) stitching
- Radius arms with straight back profile
- Black resin feet

## Natalie Features

- Transitional style that complements traditional or modern interiors
- Scroll arms with camelback profile
- Welt cord trim
- Black resin feet



9642 Natalie Loveseat



9641 Natalie Club Chair  
9621 Cassy Club Chair

## Cassy/Natalie

### 9621 Cassy Club Chair

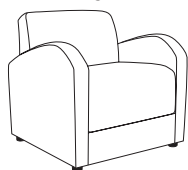

FREIGHT CLASS: 175  
CUBIC FT: 24  
SHIP WEIGHT: 60

**QS**

31" W X 28" D X 30" H

St. Yardage: 5.75

Grade	1	2	3	4	5	6	7	8	9	10	L	LL
Zone 1	1174	1341	1446	1509	1599	1734	1787	2006	2142	2312	2759	3399
Zone 2	1192	1361	1468	1532	1623	1760	1814	2036	2174	2347	2800	3450
Zone 3	1209	1381	1489	1554	1647	1786	1841	2066	2206	2381	2842	3501

- Radius arms, straight back
- Fixed seat
- See features in series overview
- Seat: 23"W x 20"D x 19"H

OPTION	PRICE	CODE
Softer Seat Foam-Chair	16.00	SF

### 9622 Cassy Loveseat

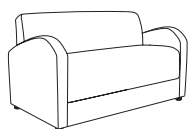

FREIGHT CLASS: 175  
CUBIC FT: 41  
SHIP WEIGHT: 90

**QS**

53" W X 28" D X 30" H

St. Yardage: 7.75

Grade	1	2	3	4	5	6	7	8	9	10	L	LL
Zone 1	2009	2301	2440	2569	2749	2818	3108	3287	3511	3937	4506	4946
Zone 2	2039	2336	2477	2608	2790	2860	3155	3336	3564	3996	4574	5020
Zone 3	2069	2370	2513	2646	2831	2903	3201	3386	3616	4055	4641	5094

- Radius arms, straight back
- Fixed seat
- See features in series overview
- Seat: 45.5"W x 20"D x 19"H

OPTION	PRICE	CODE
Softer Seat Foam-Loveseat	32.00	SF

### 9623 Cassy Sofa

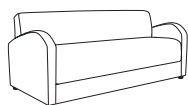

FREIGHT CLASS: 175  
CUBIC FT: 55  
SHIP WEIGHT: 120

**QS**

76" W X 28" D X 30" H

St. Yardage: 9.25

Grade	1	2	3	4	5	6	7	8	9	10	L	LL
Zone 1	2689	2962	3143	3244	3419	3653	3743	4120	4354	4646	5301	5929
Zone 2	2729	3006	3190	3293	3470	3708	3799	4182	4419	4716	5381	6018
Zone 3	2770	3051	3237	3341	3522	3763	3855	4244	4485	4785	5460	6107

- Radius arms, straight back
- Fixed seat
- See features in series overview
- Seat: 69"W x 20"D x 19"H

OPTION	PRICE	CODE
Softer Seat Foam-Sofa	48.00	SF



**9641 Natalie Club Chair**

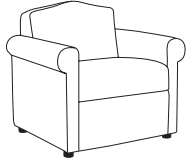

FREIGHT CLASS: 175  
CUBIC FT: 24  
SHIP WEIGHT: 77

**QS**

34" W X 28" D X 31" H

St. Yardage: 6

Grade	1	2	3	4	5	6	7	8	9	10	L	LL
<b>Zone 1</b>	1174	1341	1446	1509	1599	1734	1787	2006	2142	2312	2759	3399
<b>Zone 2</b>	1192	1361	1468	1532	1623	1760	1814	2036	2174	2347	2800	3450
<b>Zone 3</b>	1209	1381	1489	1554	1647	1786	1841	2066	2206	2381	2842	3501

- Scroll arms, camelback
- Fixed seat
- See features in series overview
- Seat: 23"W x 20"D x 19"H

OPTION	PRICE	CODE
Softer Seat Foam-Chair	16.00	SF

**9642 Natalie Loveseat**



FREIGHT CLASS: 175  
CUBIC FT: 41  
SHIP WEIGHT: 90

**QS**

56.5" W X 28" D X 31" H

St. Yardage: 8

Grade	1	2	3	4	5	6	7	8	9	10	L	LL
<b>Zone 1</b>	2009	2301	2440	2569	2749	2818	3108	3287	3511	3937	4506	4946
<b>Zone 2</b>	2039	2336	2477	2608	2790	2860	3155	3336	3564	3996	4574	5020
<b>Zone 3</b>	2069	2370	2513	2646	2831	2903	3201	3386	3616	4055	4641	5094

- Scroll arms, camelback
- Fixed seat
- See features in series overview
- Seat: 45.5"W x 20"D x 19"H

OPTION	PRICE	CODE
Softer Seat Foam-Loveseat	32.00	SF

**9643 Natalie Sofa**

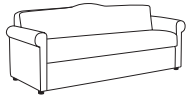

FREIGHT CLASS: 175  
CUBIC FT: 55  
SHIP WEIGHT: 120

**QS**

80" W X 28" D X 31" H

St. Yardage: 10

Grade	1	2	3	4	5	6	7	8	9	10	L	LL
<b>Zone 1</b>	2689	2962	3143	3244	3419	3653	3743	4120	4354	4646	5301	5929
<b>Zone 2</b>	2729	3006	3190	3293	3470	3708	3799	4182	4419	4716	5381	6018
<b>Zone 3</b>	2770	3051	3237	3341	3522	3763	3855	4244	4485	4785	5460	6107

- Scroll arm, camelback
- Fixed seat
- See features in series overview
- Seat: 69"W x 20"D x 19"H

OPTION	PRICE	CODE
Softer Seat Foam-Sofa	48.00	SF

ALL FOAM & FABRICS USED ARE CAL 117 APPROVED

**QS** indicates a Quickship item if ordered in Quickship upholstery.  
Quick Ship is not available on any item ordered with options.

### Public Seating: Elegant Style

**Plaza** features a simple, modern style fully upholstered for elegant appearance.

Generous armrests and usable seat area ensure comfort.



**9601 Club Chair**  
with optional arm cap

### Plaza Features

- *Standard 7.5" floor clearance simplifies cleaning*
- *Removable seat/back cushions allow quick cleanup*
- *Replacement cushions can be ordered for updating furniture appearance*
- *Reinforced black resin feet keep fabric from contacting floor*

### Options Available

- *Optional wood armcaps available*
- *Two color upholstery combinations available*



## Plaza

### 9601 Club Chair, Fully Upholstered

31.5" W X 31.5" D X 30" H

St. Yardage: 6

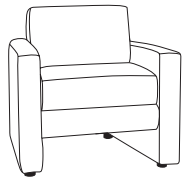

FREIGHT CLASS: 175  
CUBIC FT: 24  
SHIP WEIGHT: 71

**QS**

Grade	1	2	3	4	5	6	7	8	9	10	L	LL
Zone 1	1077	1192	1307	1485	1595	1665	1876	2006	2169	2479	2795	3213
Zone 2	1093	1210	1327	1507	1619	1690	1904	2036	2202	2516	2837	3261
Zone 3	1109	1228	1346	1530	1643	1715	1932	2066	2234	2553	2879	3309

- Black 3/4"H cylindrical feet
- See features in series overview above
- Seat: 22.5"W x 20"D x 19"H

OPTION	PRICE	CODE
Softer Seat Foam-Chair	16.00	SF

### 9602 Loveseat, Fully Upholstered

54" W X 31.5" D X 30" H

St. Yardage: 8.75

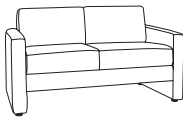

FREIGHT CLASS: 175  
CUBIC FT: 41  
SHIP WEIGHT: 99

**QS**

Grade	1	2	3	4	5	6	7	8	9	10	L	LL
Zone 1	1368	1572	1778	1840	1962	2153	2226	2533	2723	2961	3713	4404
Zone 2	1389	1596	1805	1868	1991	2185	2259	2571	2764	3005	3769	4470
Zone 3	1409	1619	1831	1895	2021	2218	2293	2609	2805	3050	3824	4536

- Black 3/4"H cylindrical feet
- See features in series overview above
- Seat: 45"W x 20"D x 19"H

OPTION	PRICE	CODE
Softer Seat Foam-Loveseat	32.00	SF

### 9603 Sofa, Fully Upholstered

76.5" W X 31.5" D X 30" H

St. Yardage: 12.5

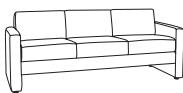

FREIGHT CLASS: 175  
CUBIC FT: 55  
SHIP WEIGHT: 125

**QS**

Grade	1	2	3	4	5	6	7	8	9	10	L	LL
Zone 1	1604	1889	2176	2249	2453	2725	2830	3268	3540	3880	5025	5855
Zone 2	1628	1917	2209	2283	2490	2766	2872	3317	3593	3938	5100	5943
Zone 3	1652	1946	2241	2316	2527	2807	2915	3366	3646	3996	5176	6031

- Black 3/4"H cylindrical feet
- See features in series overview above
- Seat: 67.5"W x 20"D x 19"H

OPTION	PRICE	CODE
Softer Seat Foam-Sofa	48.00	SF

**ACW\_ Arm Caps, Wood Finish**

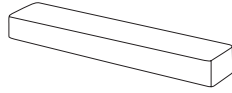

- For 9601, 9602 or 9603
- Set of 2 pre-installed wood finish arm caps
- Specify finish indicator at end of model number

FREIGHT CLASS:

Zone Pricing		1	2	3
Cubic Ft:	Ship Weight: 2	<b>232</b>	<b>235</b>	<b>239</b>
ACWAP - Aspen				
ACWFM - Natural				
ACWHCY - Honey Cherry				
ACWMAH - Mahogany				
ACWRM - Rouge Mahogany				
ACWESP - Espresso				
ACWMOB - Moab				
ACWPW - Pearwood				
ACWWAL - Walnut				
ACWWC - Windsor Cherry				
ACWCCY - Classic Cherry				
ACWBLK - Black				

**QS**

**ACE Arm Caps, Black Finish MDF**

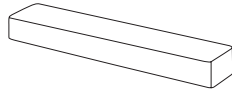

- For 9601, 9602 or 9603
- Set of 2 pre-installed black MDF arm caps
- Specify ACE at end of model number

FREIGHT CLASS:

Cubic Ft:	Ship Weight: 2	<b>193</b>	<b>196</b>	<b>199</b>
-----------	----------------	------------	------------	------------

**QS**

**UP9600SC Replacement Seat Cushion**

22.5" W X 23" D X 5" H

St. Yardage: 2



FREIGHT CLASS: 300  
CUBIC FT: 4.5  
SHIP WEIGHT: 8.7

Grade	1	2	3	4	5	6	7	8	9	10	L	LL
<b>Zone 1</b>	<b>294</b>	<b>325</b>	<b>354</b>	<b>365</b>	<b>397</b>	<b>430</b>	<b>473</b>	<b>490</b>	<b>560</b>	<b>604</b>	<b>726</b>	<b>906</b>
<b>Zone 2</b>	<b>298</b>	<b>330</b>	<b>359</b>	<b>370</b>	<b>403</b>	<b>436</b>	<b>480</b>	<b>497</b>	<b>568</b>	<b>613</b>	<b>737</b>	<b>920</b>
<b>Zone 3</b>	<b>303</b>	<b>335</b>	<b>365</b>	<b>376</b>	<b>409</b>	<b>443</b>	<b>487</b>	<b>505</b>	<b>577</b>	<b>622</b>	<b>748</b>	<b>933</b>

- For 9601, 9602 or 9603
- Removable cushion cover (zipper access)
- Can ship via small package ground service

OPTION	PRICE	CODE
Softer Seat Foam-Chair	16.00	SF

**QS**

**UP9600BC**

22.5" W X 4" D X 13" H

St. Yardage: 1.25

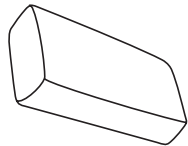

FREIGHT CLASS: 400  
CUBIC FT: 3.2  
SHIP WEIGHT: 4

Grade	1	2	3	4	5	6	7	8	9	10	L	LL
<b>Zone 1</b>	<b>236</b>	<b>252</b>	<b>272</b>	<b>301</b>	<b>321</b>	<b>348</b>	<b>359</b>	<b>402</b>	<b>430</b>	<b>464</b>	<b>520</b>	<b>681</b>
<b>Zone 2</b>	<b>240</b>	<b>256</b>	<b>276</b>	<b>306</b>	<b>326</b>	<b>353</b>	<b>364</b>	<b>408</b>	<b>436</b>	<b>471</b>	<b>528</b>	<b>691</b>
<b>Zone 3</b>	<b>243</b>	<b>260</b>	<b>280</b>	<b>310</b>	<b>331</b>	<b>358</b>	<b>370</b>	<b>414</b>	<b>443</b>	<b>478</b>	<b>536</b>	<b>701</b>

- For 9601, 9602 or 9603
- Removable cushion cover (zipper access)
- Can ship via small package ground service

**QS**

ALL FOAM & FABRICS USED ARE CAL 117 APPROVED

**QS** indicates a Quickship item if ordered in Quickship upholstery. Quick Ship is not available on any item ordered with options.

# 6700 SERIES SIN VARIOUS

## FINISH SELECTION

ASPEN **AP** | NATURAL **FM** | HONEY CHERRY **HCY** | MAHOGANY **MAH** | NATURAL OAK **NOK** |  
 MEDIUM OAK **OAK** | ROUGE MAHOGANY **RM** | WALNUT **WAL** | WINDSOR CHERRY **WC** |  
 CLASSIC CHERRY **CCY** | ESPRESSO **ESP** | PEARWOOD **PW** | BLACK **BLK** |

CONTEMPORARY

### Graceful, Art Deco Design

**6700 Series** blends gracefully shaped arms with tapered, wood legs, in a design reminiscent of Art Deco styles. A complete collection, **6700 Series** complements upholstered seating with wood occasional tables featuring veneer tops and coordinating tapered, solid wood legs.

### 6700 Details

- *Tapered, wood legs*
- *Loose seat cushions allow for easy cleaning*
- *Coordinating occasional tables*



**6720 Cocktail Table**  
**6723 End Table**



**6701 Club Chair**

## 6700 Series

### 6701 Club Chair

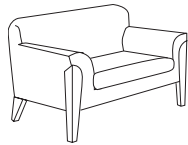

FREIGHT CLASS: 175  
 CUBIC FT: 24  
 SHIP WEIGHT: 63

**QS**

36" W X 30" D X 29" H

St. Yardage: 6

Grade	1	2	3	4	5	6	7	8	9	10	L	LL
Zone 1	1516	1723	1905	1975	2121	2178	2415	2562	2745	3093	3319	3996
Zone 2	1539	1749	1934	2005	2153	2211	2451	2600	2786	3139	3369	4056
Zone 3	1561	1775	1962	2034	2185	2243	2487	2639	2827	3186	3419	4116

- Loose seat cushions with zipper access
- Tapered wood legs in finishes listed above
- Seat: 23.5"W x 21"D x 18"H

SIN #711-16

OPTION	PRICE	CODE
Softer Seat Foam-Chair	16.00	SF

### 6702 Loveseat

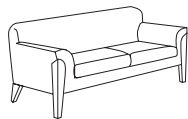

FREIGHT CLASS: 175  
 CUBIC FT: 41  
 SHIP WEIGHT: 89

**QS**

61.5" W X 30" D X 29" H

St. Yardage: 8.25

Grade	1	2	3	4	5	6	7	8	9	10	L	LL
Zone 1	2004	2290	2535	2632	2833	2911	3236	3427	3688	4181	4766	5297
Zone 2	2034	2324	2573	2671	2875	2955	3285	3478	3743	4244	4837	5376
Zone 3	2064	2359	2611	2711	2918	2998	3333	3530	3799	4306	4909	5456

- Loose seat cushions with zipper access
- Tapered wood legs in finishes listed above
- Seat: 47"W x 21"D x 18"H

SIN #711-16

OPTION	PRICE	CODE
Softer Seat Foam-Loveseat	32.00	SF

### 6703 Sofa

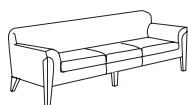

FREIGHT CLASS: 175  
 CUBIC FT: 53  
 SHIP WEIGHT: 108

**QS**

86" W X 30" D X 29" H

St. Yardage: 10

Grade	1	2	3	4	5	6	7	8	9	10	L	LL
Zone 1	2500	2855	3148	3247	3486	3579	3965	4204	4503	5071	5916	6556
Zone 2	2538	2898	3195	3296	3538	3633	4024	4267	4571	5147	6005	6654
Zone 3	2575	2941	3242	3344	3591	3686	4084	4330	4638	5223	6093	6753

- Loose seat cushions with zipper access
- Tapered wood legs in finishes listed above
- Seat: 71"W x 21"D x 18"H

SIN #711-16

OPTION	PRICE	CODE
Softer Seat Foam-Sofa	48.00	SF

# FINISH SELECTION

ASPEN **AP** | NATURAL **FM** | HONEY CHERRY **HCY** | MAHOGANY **MAH** | NATURAL OAK **NOK** |  
 MEDIUM OAK **OAK** | ROUGE MAHOGANY **RM** | WALNUT **WAL** | WINDSOR CHERRY **WC** |  
 CLASSIC CHERRY **CCY** | ESPRESSO **ESP** | PEARWOOD **PW** | BLACK **BLK** |

# SIN VARIOUS 6700 SERIES

CONTEMPORARY

### 6720 Cocktail Table, Wood Veneer Top

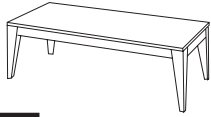

**QS**

- Solid hardwood legs
- Veneer top
- Available in all seating finishes
- Assembly required

FREIGHT CLASS: 85

### 6723 End Table, Wood Veneer Top

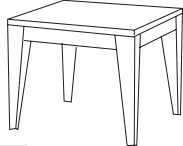

**QS**

- Solid hardwood legs
- Veneer top
- Available in all seating finishes
- Assembly required

FREIGHT CLASS: 85

### 6730 Cocktail Table, Laminate Top

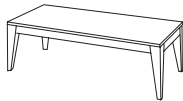

**QS**

- Solid hardwood legs
- TFL top with AdvantEdge banding
- Available in (FM) Natural Maple and (WC) Windsor Cherry only
- Assembly required

FREIGHT CLASS: 85

### 6733 End Table, Laminate Top

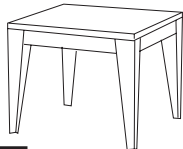

**QS**

- Solid hardwood legs
- TFL top with AdvantEdge banding
- Available in (FM) Natural Maple and (WC) Windsor Cherry only
- Assembly required

FREIGHT CLASS: 85

		Zone Pricing	1	2	3
54"W X 24"D X 16"H	Cubic Ft: 5 Ship Weight: 55		<b>1034</b>	<b>1050</b>	<b>1065</b>
<b>SIN #711-11</b>					
24"W X 28"D X 20"H	Cubic Ft: 3 Ship Weight: 40		<b>768</b>	<b>780</b>	<b>791</b>
<b>SIN #711-11</b>					
54"W X 24"D X 16"H	Cubic Ft: 5 Ship Weight: 65		<b>1024</b>	<b>1039</b>	<b>1055</b>
<b>SIN #711-11</b>					
24"W X 28"D X 20"H	Cubic Ft: 3 Ship Weight: 40		<b>760</b>	<b>771</b>	<b>783</b>
<b>SIN #711-11</b>					

ALL FOAM & FABRICS USED ARE CAL 117 APPROVED

**QS** indicates a Quickship item if ordered in Quickship upholstery. Quick Ship is not available on any item ordered with options.

# 9100 SERIES SIN VARIOUS

## FINISH SELECTION

ASPEN **AP** | BLACK **BLK** | HONEY CHERRY **HCY** | ROUGE MAHOGANY **RM** | MAHOGANY **MAH** |  
 MOAB **MOB** | PEARWOOD **PW** | WALNUT **WAL** | WINDSOR CHERRY **WC** |  
 CLASSIC CHERRY **CCY** | ESPRESSO **ESP** |

CONTEMPORARY

### Luxurious Comfort, Curved Wood Accent

**9100 Lounge Seating** provides luxurious comfort with a unique, compound-curved wood accent. Flare arm design, contoured lumbar support and generous scale create comfortable proportion and relaxed seating. Seat cushions feature extra-thick, multi-density foam for support and are removable for easy cleaning.

### 9100 Series Features

- Flare arm design with wood accent
- Extra-thick, multi-density foam
- Generous scale
- Coordinating occasional tables feature veneer tops and the natural beauty of wood



## 9100 Series

### 9131 Lounge Chair

35" W X 35" D X 29" H

St. Yardage: 5.75



FREIGHT CLASS: 175  
 CUBIC FT: 24  
 SHIP WEIGHT: 79

QS

Grade	1	2	3	4	5	6	7	8	9	10	L	LL
Zone 1	1718	1889	2040	2126	2256	2306	2517	2547	2810	3120	3354	3756
Zone 2	1744	1917	2071	2158	2290	2341	2555	2585	2852	3167	3404	3812
Zone 3	1770	1946	2101	2190	2324	2375	2593	2623	2894	3214	3455	3869

- Flared arms with curved hardwood accents
- Loose seat cushions with zipper access
- See features in series overview
- Seat: 24"W x 20.5"D x 19"H

OPTION	PRICE	CODE
Softer Seat Foam-Chair	16.00	SF

SIN #711-16

### 9132 Loveseat

59" W X 35" D X 30" H

St. Yardage: 7.5

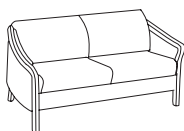

FREIGHT CLASS: 175  
 CUBIC FT: 42  
 SHIP WEIGHT: 105

QS

Grade	1	2	3	4	5	6	7	8	9	10	L	LL
Zone 1	2418	2671	2871	2995	3180	3252	3550	3735	3966	4404	5044	5301
Zone 2	2454	2711	2914	3040	3228	3301	3603	3791	4025	4470	5120	5381
Zone 3	2491	2751	2957	3085	3275	3350	3657	3847	4085	4536	5195	5460

- Flared arms with curved hardwood accents
- Loose seat cushions with zipper access
- See features in series overview
- Seat: 48"W x 20.5"D x 19"H

OPTION	PRICE	CODE
Softer Seat Foam-Loveseat	32.00	SF

SIN #711-16

### 9133 Sofa

83" W X 35" D X 30" H

St. Yardage: 9.5

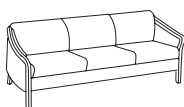

FREIGHT CLASS: 175  
 CUBIC FT: 56  
 SHIP WEIGHT: 138

QS

Grade	1	2	3	4	5	6	7	8	9	10	L	LL
Zone 1	3030	3326	3591	3743	3972	4160	4428	4656	4942	5484	6068	6577
Zone 2	3075	3376	3645	3799	4032	4222	4494	4726	5016	5566	6159	6676
Zone 3	3121	3426	3699	3855	4091	4285	4561	4796	5090	5649	6250	6774

- Flared arms with curved hardwood accents
- Loose seat cushions with zipper access
- See features in series overview
- Seat: 72"W x 20.5"D x 19"H

OPTION	PRICE	CODE
Softer Seat Foam-Sofa	48.00	SF

SIN #711-16



FINISH SELECTION

ASPEN **AP** | BLACK **BLK** | HONEY CHERRY **HCY** | ROUGE MAHOGANY **RM** | MAHOGANY **MAH** |  
 MOAB **MOB** | PEARWOOD **PW** | WALNUT **WAL** | WINDSOR CHERRY **WC** |  
 CLASSIC CHERRY **CCY** | ESPRESSO **ESP** |

SIN VARIOUS **9100 SERIES**

CONTEMPORARY

**9138 Chair**

25" W X 27" D X 32.5" H

St. Yardage: 3

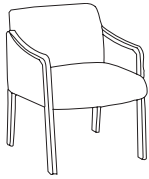

FREIGHT CLASS: 175  
 CUBIC FT: 15  
 SHIP WEIGHT: 38

Grade	1	2	3	4	5	6	7	8	9	10	L	LL
<b>Zone 1</b>	1017	1111	1190	1238	1308	1336	1450	1520	1609	1777	1974	2120
<b>Zone 2</b>	1032	1128	1208	1257	1328	1356	1472	1543	1633	1804	2004	2152
<b>Zone 3</b>	1048	1144	1226	1275	1347	1376	1494	1566	1657	1830	2033	2184

- Curved hardwood arms
- Upholstered arm inserts
- See features in series overview
- Seat: 20"W x 18.25"D x 20.25"H

OPTION	PRICE	CODE
Softer Seat Foam-Chair	16.00	SF

SIN #711-16

**QS**

**9120 Cocktail Table**

- Wood veneer top
- Solid hardwood legs
- Available in all seating finishes listed
- Ships assembled

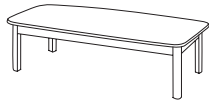

FREIGHT CLASS: 150

54"W X 24"D X 16.5"H

Cubic Ft: 16 Ship Weight: 65

Zone Pricing	1	2	3
--------------	---	---	---

**1001 1016 1031**

SIN #711-11

**QS**

**9123 End Table**

- Wood veneer top
- Solid hardwood legs
- Available in all seating finishes listed
- Ships assembled

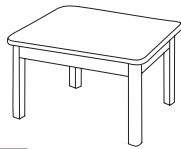

FREIGHT CLASS: 150

24"W X 28"D X 25"H

Cubic Ft: 9 Ship Weight: 40

**719 730 741**

SIN #711-11

**QS**

ALL FOAM & FABRICS USED ARE CAL 117 APPROVED

**QS** indicates a Quickship item if ordered in Quickship upholstery. Quick Ship is not available on any item ordered with options.

# 7200 SERIES SIN VARIOUS

## FINISH SELECTION

ASPEN **AP** | HONEY CHERRY **HCY** | ROUGE MAHOGANY **RM** | MAHOGANY **MAH** | NATURAL OAK **NOK** | PEARWOOD **PW** | WALNUT **WAL** | WINDSOR CHERRY **WC** | CLASSIC CHERRY **CCY** | ESPRESSO **ESP** | MEDIUM OAK **OAK** | BLACK **BLK** |

CONTEMPORARY

### Standing the Test of Time

The **7200 Lounge Series**, with oak frame, provides classic durability. Loose seat and back cushions with zipper access for easy cleaning. This collection is perfect for high-traffic areas and includes chairs, sofas, benches and occasional tables.

#### 7200 Details

- *Hardwood arms and legs*
- *Loose seat cushions allow for easy cleaning*
- *Coordinating occasional tables*



7200 Configuration

## 7200 Series

### 7201 Club Chair

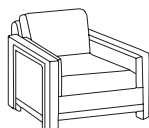

FREIGHT CLASS: 175  
CUBIC FT: 28  
SHIP WEIGHT: 88

**QS**

35.5" W X 33" D X 27" H

St. Yardage: 6.75

Grade	1	2	3	4	5	6	7	8	9	10	L	LL
Zone 1	1686	1893	2065	2162	2314	2373	2618	2770	2960	2960	3422	4057
Zone 2	1711	1921	2096	2194	2349	2409	2657	2812	3004	3004	3473	4118
Zone 3	1737	1950	2127	2227	2383	2444	2697	2853	3049	3049	3525	4179

- Upholstered arm inserts
- Loose seat cushions
- Zipper access cushions
- Seat: 24"W x 20.75"D x 16"H

OPTION	PRICE	CODE
Softer Seat Foam-Chair	16.00	SF

**SIN #711-16**

### 7202 Loveseat

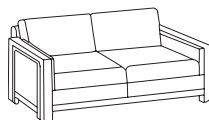

FREIGHT CLASS: 175  
CUBIC FT: 41  
SHIP WEIGHT: 117

**QS**

60" W X 33" D X 27" H

St. Yardage: 9

Grade	1	2	3	4	5	6	7	8	9	10	L	LL
Zone 1	2377	2670	2918	3056	3274	3358	3709	3926	4198	4614	5037	5779
Zone 2	2413	2710	2962	3102	3323	3408	3765	3985	4261	4683	5113	5866
Zone 3	2448	2750	3006	3148	3372	3459	3820	4044	4324	4752	5188	5952

- Upholstered arm inserts
- Loose seat cushions with zipper access
- Other features listed in series overview above
- Seat: 49.25"W x 20.75"D x 16"H

OPTION	PRICE	CODE
Softer Seat Foam-Loveseat	32.00	SF

**SIN #711-16**

### 7203 Sofa

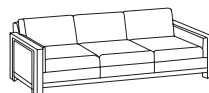

FREIGHT CLASS: 175  
CUBIC FT: 53  
SHIP WEIGHT: 138

**QS**

84" W X 33" D X 27" H

St. Yardage: 11.5

Grade	1	2	3	4	5	6	7	8	9	10	L	LL
Zone 1	2967	3332	3646	3816	4088	4193	4531	4903	5343	5888	6817	7221
Zone 2	3012	3382	3701	3873	4149	4256	4599	4977	5423	5976	6919	7329
Zone 3	3056	3432	3755	3930	4211	4319	4667	5050	5503	6065	7022	7438

- Upholstered arm inserts
- Loose seat cushions with zipper access
- Other features listed in series overview above
- Seat: 73"W x 20.75"D x 16"H

OPTION	PRICE	CODE
Softer Seat Foam-Loveseat Sofa	48.00	SF

**SIN #711-16**

# FINISH SELECTION

ASPEN **AP** | HONEY CHERRY **HCY** | ROUGE MAHOGANY **RM** | MAHOGANY **MAH** | NATURAL OAK **NOK** | PEARWOOD **PW** | WALNUT **WAL** | WINDSOR CHERRY **WC** | CLASSIC CHERRY **CCY** | ESPRESSO **ESP** | MEDIUM OAK **OAK** | BLACK **BLK** |

# SIN VARIOUS 7200 SERIES

CONTEMPORARY

## 7220 Cocktail Table

- Hardwood veneer top
- All finishes on oak frame



**QS**

FREIGHT CLASS: 150

		Zone Pricing	1	2	3
52"W X 24"D X 16" H	Cubic Ft: 16 Ship Weight: 65		<b>1133</b>	<b>1150</b>	<b>1167</b>
		<b>SIN #711-11</b>			

## 7223 End Table

- Hardwood veneer top
- All finishes on oak frame

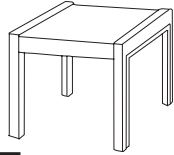

**QS**

FREIGHT CLASS: 150

		Zone Pricing	1	2	3
22"W X 27"D X 19" H	Cubic Ft: 13 Ship Weight: 40		<b>914</b>	<b>928</b>	<b>941</b>
		<b>SIN #711-11</b>			

## 7248 Reception Bench

48" W X 16" D X 16" H St. Yardage: 2



FREIGHT CLASS: 175  
CUBIC FT: 10  
SHIP WEIGHT: 40

**QS**

Grade	1	2	3	4	5	6	7	8	9	10	L	LL
<b>Zone 1</b>	<b>1126</b>	<b>1188</b>	<b>1234</b>	<b>1262</b>	<b>1305</b>	<b>1332</b>	<b>1392</b>	<b>1436</b>	<b>1490</b>	<b>1593</b>	<b>1738</b>	<b>1805</b>
<b>Zone 2</b>	<b>1143</b>	<b>1206</b>	<b>1253</b>	<b>1281</b>	<b>1325</b>	<b>1352</b>	<b>1413</b>	<b>1458</b>	<b>1512</b>	<b>1617</b>	<b>1764</b>	<b>1832</b>
<b>Zone 3</b>	<b>1160</b>	<b>1224</b>	<b>1271</b>	<b>1300</b>	<b>1344</b>	<b>1372</b>	<b>1434</b>	<b>1479</b>	<b>1535</b>	<b>1641</b>	<b>1790</b>	<b>1859</b>

- Upholstered seat
- All finishes on oak frame
- Seat: 43.5"W x 16"D x 16"H

OPTION	PRICE	CODE
Softer Seat Foam-Loveseat	32.00	SF

**SIN #711-16**

## 7272 Reception Bench

72" W X 16" D X 16" H St. Yardage: 3



FREIGHT CLASS: 175  
CUBIC FT: 14  
SHIP WEIGHT: 45

**QS**

Grade	1	2	3	4	5	6	7	8	9	10	L	LL
<b>Zone 1</b>	<b>1303</b>	<b>1392</b>	<b>1467</b>	<b>1507</b>	<b>1572</b>	<b>1597</b>	<b>1623</b>	<b>1702</b>	<b>1768</b>	<b>1849</b>	<b>2004</b>	<b>2322</b>
<b>Zone 2</b>	<b>1323</b>	<b>1413</b>	<b>1489</b>	<b>1530</b>	<b>1596</b>	<b>1621</b>	<b>1647</b>	<b>1728</b>	<b>1795</b>	<b>1877</b>	<b>2034</b>	<b>2357</b>
<b>Zone 3</b>	<b>1342</b>	<b>1434</b>	<b>1511</b>	<b>1552</b>	<b>1619</b>	<b>1645</b>	<b>1672</b>	<b>1753</b>	<b>1821</b>	<b>1904</b>	<b>2064</b>	<b>2392</b>

- Upholstered seat
- All finishes on oak frame
- Seat: 67.5"W x 16"D x 16"H

OPTION	PRICE	CODE
Softer Seat Foam-Sofa	48.00	SF

**SIN #711-16**

ALL FOAM & FABRICS USED ARE CAL 117 APPROVED

**QS** indicates a Quickship item if ordered in Quickship upholstery. Quick Ship is not available on any item ordered with options.

# 7500 SERIES SIN VARIOUS

## FINISH SELECTION

ASPEN **AP** | HONEY CHERRY **HCY** | ROUGE MAHOGANY **RM** | MAHOGANY **MAH** | NATURAL OAK **NOK** | PEARWOOD **PW** | WALNUT **WAL** | WINDSOR CHERRY **WC** | CLASSIC CHERRY **CCY** | ESPRESSO **ESP** | BLACK **BLK** |

CONTEMPORARY

### Strength and Support

The 7500 Lounge Series, with oak frame, provides classic durability. Sled base design on all seating, tables and benches. Exposed wood frames are available in the finishes listed above on oak wood.

This collection is perfect for high-traffic areas and includes chairs, sofas, benches and occasional tables.

### 7500 Design Details

- Hardwood arms and legs
- Replaceable seat and back unit will increase product life
- Extra-thick foam cushions add comfort
- Coordinating occasional tables

### Additional Information

- 1000's of upholstery selections available to fit the decor of any reception area.



7500 Configuration

## 7500 Series

### 7501 Sled Base Chair

29" W X 29" D X 29" H

St. Yardage: 2.25

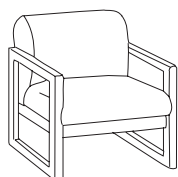

FREIGHT CLASS: 175  
CUBIC FT: 16  
SHIP WEIGHT: 52

**QS**

Grade	1	2	3	4	5	6	7	8	9	10	L	LL
Zone 1	1070	1141	1205	1240	1294	1315	1340	1403	1457	1525	1654	1920
Zone 2	1086	1158	1223	1259	1313	1335	1360	1424	1479	1548	1679	1949
Zone 3	1102	1175	1241	1277	1333	1354	1380	1445	1501	1571	1704	1978

- Oak frame in a sled base design
- See features in series overview above
- Seat: 24.5"W x 20.75"D x 17.5"H

OPTION	PRICE	CODE
Softer Seat Foam-Chair	16.00	SF

**SIN #711-16**

### 7502 Sled Base Loveseat

54" W X 29" D X 29" H

St. Yardage: 4.25

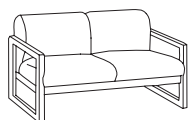

FREIGHT CLASS: 175  
CUBIC FT: 41  
SHIP WEIGHT: 98

**QS**

Grade	1	2	3	4	5	6	7	8	9	10	L	LL
Zone 1	1681	1820	1944	2021	2129	2171	2231	2347	2455	2591	2949	3377
Zone 2	1706	1847	1973	2051	2161	2204	2264	2382	2492	2630	2993	3428
Zone 3	1731	1875	2002	2082	2193	2236	2298	2417	2529	2669	3037	3478

- Oak frame in a sled base design
- See features in series overview above
- Seat: 49"W x 20.75"D x 17.5"H

OPTION	PRICE	CODE
Softer Seat Foam-Loveseat	32.00	SF

**SIN #711-16**

### 7503 Sled Base Sofa

79" W X 29" D X 29" H

St. Yardage: 6.25



FREIGHT CLASS: 175  
CUBIC FT: 53  
SHIP WEIGHT: 127

**QS**

Grade	1	2	3	4	5	6	7	8	9	10	L	LL
Zone 1	2206	2414	2599	2716	2879	3105	3368	3571	3751	3959	4276	4742
Zone 2	2239	2450	2638	2757	2922	3152	3419	3625	3807	4018	4340	4813
Zone 3	2272	2486	2677	2797	2965	3198	3469	3678	3864	4078	4404	4884

- Oak frame in a sled base design
- See features in series overview above
- Seat: 73.5"W x 20.75"D x 17.5"H

OPTION	PRICE	CODE
Softer Seat Foam-Sofa	48.00	SF

**SIN #711-16**

**QS**

ALL FOAM & FABRICS USED ARE CAL 117 APPROVED indicates a Quickship item if ordered in Quickship upholstery. Quick Ship is not available on any item ordered with options.

FINISH SELECTION

ASPEN **AP** | HONEY CHERRY **HCY** | ROUGE MAHOGANY **RM** | MAHOGANY **MAH** | NATURAL OAK **NOK** |  
 MEDIUM OAK **OAK** | PEARWOOD **PW** | WALNUT **WAL** | WINDSOR CHERRY **WC** | CLASSIC CHERRY **CCY** |  
 ESPRESSO **ESP** | BLACK **BLK** |

SIN VARIOUS **7500 SERIES**

**7520 Cocktail Table**

- Hardwood veneer top
- All finishes on oak frame



**QS**

FREIGHT CLASS: 150

**7523 End Table**

- Hardwood veneer top
- All finishes on oak frame

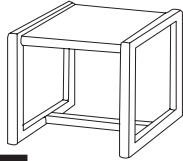

**QS**

FREIGHT CLASS: 150

		Zone Pricing	1	2	3
52"W X 24"D X 16" H	Cubic Ft: 16 Ship Weight: 67		<b>1085</b>	<b>1101</b>	<b>1118</b>
<b>SIN #711-11</b>					
22.5"W X 27"D X 19.5" H	Cubic Ft: 9 Ship Weight: 45		<b>755</b>	<b>766</b>	<b>778</b>
<b>SIN #711-11</b>					

CONTEMPORARY

ALL FOAM & FABRICS USED ARE CAL 117 APPROVED

**QS** indicates a Quickship item if ordered in Quickship upholstery.  
 Quick Ship is not available on any item ordered with options.

# 7900 SERIES SIN VARIOUS

## FINISH SELECTION

ASPEN **AP** | BLACK **BLK** | HONEY CHERRY **HCY** | ROUGE MAHOGANY **RM** | MAHOGANY **MAH** | NATURAL OAK **NOK** | MEDIUM OAK **OAK** | PEARWOOD **PW** | WALNUT **WAL** | WINDSOR CHERRY **WC** | CLASSIC CHERRY **CCY** | ESPRESSO **ESP** |

CONTEMPORARY

### Ready to Go the Distance

The **7900 Lounge Series** will go the distance with a strong oak frame, durable construction and hardwood arms. Loose seat and back cushions with zipper access for easy cleaning. This collection is perfect for high-traffic areas and includes chairs, sofas, benches and occasional tables.

#### 7900 Details

- *Hardwood arms with upholstered inset*
- *Loose seat and back cushions make cleaning simple*
- *Zipper access cushions*
- *Coordinating occasional tables*



7900 Configuration

## 7900 Series

### 7901 Sled Base Chair

35" W X 33" D X 27" H

St. Yardage: 6.75

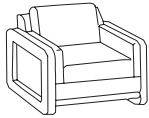

FREIGHT CLASS: 175  
CUBIC FT: 24  
SHIP WEIGHT: 85

QS

Grade	1	2	3	4	5	6	7	8	9	10	L	LL
Zone 1	1753	1957	2130	2229	2381	2440	2685	2837	3027	3389	3759	4136
Zone 2	1779	1986	2162	2262	2417	2477	2725	2880	3072	3440	3815	4198
Zone 3	1806	2016	2194	2296	2452	2513	2766	2922	3118	3491	3872	4260

- Sled base design with upholstered arm inserts
- All finishes on oak frame

- Other features in series overview
- Seat: 24"W x 21.5"D x 17.5"H

OPTION	PRICE	CODE
Softer Seat Foam-Chair	16.00	SF

SIN #711-16

### 7902 Sled Base Loveseat

59" W X 33" D X 27" H

St. Yardage: 9

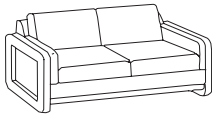

FREIGHT CLASS: 175  
CUBIC FT: 41  
SHIP WEIGHT: 123

QS

Grade	1	2	3	4	5	6	7	8	9	10	L	LL
Zone 1	2471	2743	2975	3099	3300	3378	3603	3904	4255	4633	5064	5618
Zone 2	2508	2784	3020	3145	3350	3429	3657	3963	4319	4702	5140	5702
Zone 3	2545	2825	3064	3192	3399	3479	3711	4021	4383	4772	5216	5787

- Sled base design with upholstered arm inserts
- All finishes on oak frame

- Other features in series overview
- Seat: 48"W x 21.5"D x 17.5"H

OPTION	PRICE	CODE
Softer Seat Foam-Loveseat	32.00	SF

SIN #711-16

### 7903 Sled Base Sofa

83" W X 33" D X 27" H

St. Yardage: 11.5

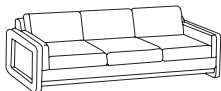

FREIGHT CLASS: 175  
CUBIC FT: 53  
SHIP WEIGHT: 162

QS

Grade	1	2	3	4	5	6	7	8	9	10	L	LL
Zone 1	3146	3496	3810	3995	4267	4372	4810	5482	5822	6267	6996	7372
Zone 2	3193	3548	3867	4055	4331	4438	4882	5564	5909	6361	7101	7483
Zone 3	3240	3601	3924	4115	4395	4503	4954	5646	5997	6455	7206	7593

- Sled base design with upholstered arm inserts
- All finishes on oak frame

- Other features in series overview
- Seat: 72"W x 21.5"D x 17.5"H

OPTION	PRICE	CODE
Softer Seat Foam-Sofa	48.00	SF

SIN #711-16

QS

ALL FOAM & FABRICS USED ARE CAL 117 APPROVED  
indicates a Quickship item if ordered in Quickship upholstery.  
Quick Ship is not available on any item ordered with options.



# FINISH SELECTION

ASPEN **AP** | BLACK **BLK** | HONEY CHERRY **HCY** | ROUGE MAHOGANY **RM** | MAHOGANY **MAH** |  
 NATURAL OAK **NOK** | MEDIUM OAK **OAK** | PEARWOOD **PW** | WALNUT **WAL** | WINDSOR CHERRY  
**WC** | CLASSIC CHERRY **CCY** | ESPRESSO **ESP** |

# SIN VARIOUS 7900 SERIES

CONTEMPORARY

## 7920 Cocktail Table



- Hardwood veneer top
- All finishes on oak frame

FREIGHT CLASS: 150

**QS**

		Zone Pricing	1	2	3
52" W X 24" D X 16" H	Cubic Ft: 16	Ship Weight: 65	<b>1134</b>	<b>1151</b>	<b>1168</b>
<b>SIN #711-11</b>					

## 7923 End Table

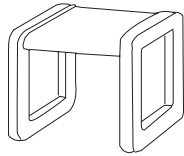

- Hardwood veneer top
- All finishes on oak frame

FREIGHT CLASS: 150

**QS**

22" W X 27" D X 19" H	Cubic Ft: 9	Ship Weight: 40	<b>912</b>	<b>926</b>	<b>939</b>
<b>SIN #711-11</b>					

## 7948 Reception Bench

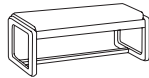

FREIGHT CLASS: 175  
 CUBIC FT: 10  
 SHIP WEIGHT: 43

**QS**

48" W X 16" D X 17" H St. Yardage: 2

Grade	1	2	3	4	5	6	7	8	9	10	L	LL
<b>Zone 1</b>	<b>1126</b>	<b>1188</b>	<b>1234</b>	<b>1262</b>	<b>1305</b>	<b>1332</b>	<b>1392</b>	<b>1436</b>	<b>1490</b>	<b>1593</b>	<b>1738</b>	<b>1805</b>
<b>Zone 2</b>	<b>1143</b>	<b>1206</b>	<b>1253</b>	<b>1281</b>	<b>1325</b>	<b>1352</b>	<b>1413</b>	<b>1458</b>	<b>1512</b>	<b>1617</b>	<b>1764</b>	<b>1832</b>
<b>Zone 3</b>	<b>1160</b>	<b>1224</b>	<b>1271</b>	<b>1300</b>	<b>1344</b>	<b>1372</b>	<b>1434</b>	<b>1479</b>	<b>1535</b>	<b>1641</b>	<b>1790</b>	<b>1859</b>

- Upholstered seat with a sled base design
- All finishes on oak frame
- Seat: 44"W x 16"D x 17"H

OPTION	PRICE	CODE
Softer Seat Foam-Loveseat	32.00	SF

**SIN #711-16**

## 7972 Reception Bench



FREIGHT CLASS: 175  
 CUBIC FT: 14  
 SHIP WEIGHT: 45

**QS**

72" W X 16" D X 17" H St. Yardage: 3

Grade	1	2	3	4	5	6	7	8	9	10	L	LL
<b>Zone 1</b>	<b>1303</b>	<b>1392</b>	<b>1467</b>	<b>1507</b>	<b>1572</b>	<b>1597</b>	<b>1623</b>	<b>1702</b>	<b>1768</b>	<b>1849</b>	<b>2004</b>	<b>2322</b>
<b>Zone 2</b>	<b>1323</b>	<b>1413</b>	<b>1489</b>	<b>1530</b>	<b>1596</b>	<b>1621</b>	<b>1647</b>	<b>1728</b>	<b>1795</b>	<b>1877</b>	<b>2034</b>	<b>2357</b>
<b>Zone 3</b>	<b>1342</b>	<b>1434</b>	<b>1511</b>	<b>1552</b>	<b>1619</b>	<b>1645</b>	<b>1672</b>	<b>1753</b>	<b>1821</b>	<b>1904</b>	<b>2064</b>	<b>2392</b>

- Upholstered seat with a sled base design
- All finishes on oak frame
- Seat: 68"W x 16"D x 17"H

OPTION	PRICE	CODE
Softer Seat Foam-Sofa	48.00	SF

**SIN #711-16**

ALL FOAM & FABRICS USED ARE CAL 117 APPROVED

**QS** indicates a Quickship item if ordered in Quickship upholstery. Quick Ship is not available on any item ordered with options.

# RECEPTION SIN VARIOUS

## FINISH SELECTION

ROUGE MAHOGANY **RM** | WINDSOR CHERRY **WC** | BLACK **BLK** | MOAB **MOB** |  
 HONEY CHERRY **HCY** | PEARWOOD **PW** | MAHOGANY **MAH** | ASPEN **AP** |  
 ESPRESSO **ESP** | CLASSIC CHERRY **CCY** | WALNUT **WAL** |

TRADITIONAL

### Period Influence, Classic Style

**Traditional Reception** features period influences to create Wing Back, Gooseneck and other classic styles. Traditional tufting, individually-placed brass nail trim and shaped wood basecaps enhance the design.

### Traditional Reception Details

- Brass nail trim
- Traditional tufting upholstery stitching is standard on all seating
- Occasional tables feature high-gloss, high-pressure laminate tops



4072 Loveseat



4053 Goose Neck Arm Chair



4075 Arm Chair

## Reception

### 4053 Goose Neck Arm Chair



Freight Class: 250  
 Cubic Ft: 23  
 Ship Weight: 48

25" W X 29" D X 43" H

St. Yardage: 3.5

Grade	1	2	3	4	5	6	7	8	9	10	L	LL
Zone 1	1588	1685	1775	1826	1902	1931	2054	2130	2225	2406	2780	2934
Zone 2	1612	1710	1802	1853	1931	1960	2085	2162	2258	2442	2822	2978
Zone 3	1636	1736	1828	1881	1959	1989	2116	2194	2292	2478	2863	3022

- Tufted seat and back
  - Goose neck arms
  - Queen Anne style legs
  - Seat: 18"W x 17.75"D x 19.5"H
- SIN 711-18

OPTION	PRICE	CODE
Non-Tufted Option	N/C	NT
Upholstered Arm Caps	114.00	UA

### 4054 Armeless Side Chair

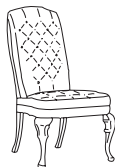

Freight Class: 250  
 Cubic Ft: 23  
 Ship Weight: 45

25" W X 29" D X 43" H

St. Yardage: 3.5

Grade	1	2	3	4	5	6	7	8	9	10	L	LL
Zone 1	1139	1189	1246	1320	1377	1453	1482	1605	1681	1776	1855	2285
Zone 2	1156	1207	1265	1340	1398	1475	1504	1629	1706	1803	1883	2319
Zone 3	1173	1225	1283	1360	1418	1497	1526	1653	1731	1829	1911	2354

- Tufted seat and back
  - Queen Anne style legs
  - Seat: 18"W x 17.75"D x 19.5"H
- SIN 711-18

OPTION	PRICE	CODE
Non-Tufted Option	N/C	NT

QS

# FINISH SELECTION

ROUGE MAHOGANY **RM** | WINDSOR CHERRY **WC** | BLACK **BLK** | MOAB **MOB** |  
 HONEY CHERRY **HCY** | PEARWOOD **PW** | MAHOGANY **MAH** | ASPEN **AP** |  
 ESPRESSO **ESP** | CLASSIC CHERRY **CCY** | WALNUT **WAL** |

# SIN VARIOUS RECEPTION

TRADITIONAL

## 4072 Loveseat

57" W X 27.5" D X 34" H

St. Yardage: 6

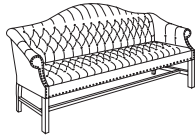

Freight Class: 175  
 Cubic Ft: 36  
 Ship Weight: 78

Grade	1	2	3	4	5	6	7	8	9	10	L	LL
Zone 1	1756	1954	2122	2215	2361	2418	2655	2802	2985	3333	4049	4259
Zone 2	1782	1983	2154	2248	2396	2454	2695	2844	3030	3383	4110	4323
Zone 3	1809	2013	2186	2281	2432	2491	2735	2886	3075	3433	4170	4387

- Tufted seat, back and inside arms
- Brass nail head trim on arms and seat
- Traditional scroll arm and camelback
- Chippendale style legs
- Cross rail adds leg support
- Seat: 47.5"W x 17.5"D x 19"H
- SIN 711-16

OPTION	PRICE	CODE
No Brass Trim Option	N/C	NB
Non-Tufted Option	N/C	NT

## 4073 Wing Back Arm Chair

27" W X 29" D X 39" H

St. Yardage: 4



Freight Class: 250  
 Cubic Ft: 20  
 Ship Weight: 48

Grade	1	2	3	4	5	6	7	8	9	10	L	LL
Zone 1	1242	1370	1485	1539	1633	1758	1806	2008	2133	2289	2506	3089
Zone 2	1261	1391	1507	1562	1657	1784	1833	2038	2165	2323	2544	3135
Zone 3	1279	1411	1530	1585	1682	1811	1860	2068	2197	2358	2581	3182

- Tufted seat and back
- Brass nail head trim on arms and seat
- Queen Anne style legs on front
- Seat: 19.5"F-16"B W x 18.25"D x 18.5"H
- SIN 711-18

OPTION	PRICE	CODE
No Brass Trim Option	N/C	NB
Non-Tufted Option	N/C	NT

## 4074 Wing Back Arm Chair

29" W X 31" D X 40.5" H

St. Yardage: 4.5



Freight Class: 250  
 Cubic Ft: 26  
 Ship Weight: 51

Grade	1	2	3	4	5	6	7	8	9	10	L	LL
Zone 1	1316	1412	1512	1665	1775	1911	1978	2215	2362	2545	2659	3319
Zone 2	1336	1433	1535	1690	1802	1940	2008	2248	2397	2583	2699	3369
Zone 3	1355	1454	1557	1715	1828	1968	2037	2281	2433	2621	2739	3419

- Full-size seat and back
- Queen Anne style legs on front
- Tufted seat and back
- Brass nail head trim on arms and seat
- Seat: 18"B-22.5"F W x 19"D x 18.5"H
- SIN 711-18

OPTION	PRICE	CODE
No Brass Trim Option	N/C	NB
Non-Tufted Option	N/C	NT

## 4075 Arm Chair

28" W X 26" D X 32" H

St. Yardage: 3.5

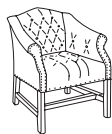

Freight Class: 250  
 Cubic Ft: 14  
 Ship Weight: 46

Grade	1	2	3	4	5	6	7	8	9	10	L	LL
Zone 1	1197	1305	1389	1435	1473	1511	1540	1663	1739	1834	2329	2543
Zone 2	1215	1325	1410	1457	1495	1534	1563	1688	1765	1862	2364	2581
Zone 3	1233	1344	1431	1478	1517	1556	1586	1713	1791	1889	2399	2619

- Tufted seat and back
- Brass nail head trim on arms and seat
- Chippendale style legs
- Cross rails for additional leg support
- Seat: 17"W x 18"D x 19.5"H
- SIN 711-18

OPTION	PRICE	CODE
No Brass Trim Option	N/C	NB
Non-Tufted Option	N/C	NT

# TRADITIONAL

SIN VARIOUS

## FINISH SELECTION

ROUGE MAHOGANY **RM** | WINDSOR CHERRY **WC** | BLACK **BLK** | MOAB **MOB** |  
 HONEY CHERRY **HCY** | PEARWOOD **PW** | MAHOGANY **MAH** | ASPEN **AP** |  
 ESPRESSO **ESP** | CLASSIC CHERRY **CCY** | WALNUT **WAL** |

TRADITIONAL

### 4083 Sofa

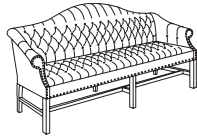

78" W X 28" D X 35" H

St. Yardage: 8

Grade	1	2	3	4	5	6	7	8	9	10	L	LL
<b>Zone 1</b>	2173	2420	2632	2750	2935	3007	3305	3490	3721	4159	4969	5199
<b>Zone 2</b>	2206	2456	2671	2791	2979	3052	3355	3542	3777	4221	5044	5277
<b>Zone 3</b>	2238	2493	2711	2833	3023	3097	3404	3595	3833	4284	5118	5355

Freight Class: 175  
 Cubic Ft: 54  
 Ship Weight: 113

- Tufted seat, back and inside arms
  - Brass nail head trim on arms and seat
  - Traditional scroll arm and camelback
  - Chippendale style legs
  - Cross rail adds leg support
  - Seat: 66"W x 18"D x 19"H
- SIN 711-16

CASTER	PRICE	CODE
No Brass Trim Option	N/C	NB
Non-Tufted Option	N/C	NT

### TR\_4020 Traditional Cocktail Table

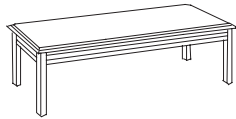

Freight Class: 100

- High-gloss, high pressure laminate top in Mahogany and Windsor Cherry
- Shaped edges
- Ships unassembled, easy assembly

			Zone Pricing	1	2	3
54" X 24" X 16"	Cubic Ft: 5.5	Ship Weight: 69.5		<b>748</b>	<b>759</b>	<b>770</b>

Finish Options: Mahogany (M), Windsor Cherry (WC) and Oak (O)  
 Note: Oak finish has a satin laminate top

SIN 711-11

QS

### TR\_4023 Traditional End Table

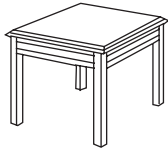

Freight Class: 92.5

- High-gloss, high pressure laminate top in Mahogany and Windsor Cherry
- Shaped edges
- Ships unassembled, easy assembly

22" X 27" X 18"	Cubic Ft: 2.5	Ship Weight: 38		<b>618</b>	<b>627</b>	<b>637</b>
-----------------	---------------	-----------------	--	------------	------------	------------

Finish Options: Mahogany (M), Windsor Cherry (WC) and Oak (O)  
 Note: Oak finish has a satin laminate top

SIN 711-11

QS

# FINISH SELECTION

ROUGE MAHOGANY **RM** | WINDSOR CHERRY **WC** | BLACK **BLK** | MOAB **MOB** |  
 HONEY CHERRY **HCY** | PEARWOOD **PW** | MAHOGANY **MAH** | ASPEN **AP** |  
 ESPRESSO **ESP** | CLASSIC CHERRY **CCY** | WALNUT **WAL** |

SIN 711-16

# CHESTERFIELD

TRADITIONAL

## Traditional Comfort

Fully-upholstered **Chesterfield**, inspired by original designs, features oversize scroll arms and extra-deep seat comfort. Accents include tufting, individually-placed brass nail trim and bun-style feet.

## Chesterfield Details

- High-density foam, no-sag sinuous spring suspensions
- Traditional tufting upholstery stitching is standard
- Brass nail trim
- Bun feet

## Additional Options

- Non-Tufted option
- No Brass Trim option



4301 Club Chair

## Chesterfield

### 4301 Club Chair

40" W X 36" D X 28" H

St. Yardage: 6.5

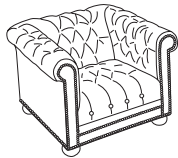

Freight Class: 175  
 Cubic Ft: 31  
 Ship Weight: 95

Grade	1	2	3	4	5	6	7	8	9	10	L	LL
Zone 1	1996	2190	2366	2472	2624	2783	2928	3080	3270	3532	4088	4216
Zone 2	2026	2223	2401	2509	2663	2825	2972	3126	3319	3585	4149	4279
Zone 3	2056	2256	2437	2546	2703	2866	3016	3172	3368	3638	4211	4342

- Extra-deep seat comfort
- Deep-well tufting
- Puzzle-joint construction, wood frame
- See features in series overview above
- Seat: 24.5"W x 23.5"D x 18"H

OPTION	PRICE	CODE
No Brass Trim Option	N/C	NB
Non-Tufted Option	N/C	NT

### 4302 Loveseat

61" W X 36" D X 28" H

St. Yardage: 9

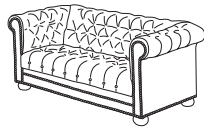

Freight Class: 175  
 Cubic Ft: 57  
 Ship Weight: 144

Grade	1	2	3	4	5	6	7	8	9	10	L	LL
Zone 1	2670	2937	3175	3315	3522	3602	3835	4141	4400	4652	4990	5680
Zone 2	2710	2981	3223	3365	3575	3656	3893	4203	4466	4722	5065	5765
Zone 3	2750	3025	3270	3414	3628	3710	3950	4265	4532	4792	5140	5850

- Extra-deep seat comfort
- Deep-well tufting
- Puzzle-joint construction, wood frame
- See features in series overview above
- Seat: 44.5"W x 23.5"D x 18"H

OPTION	PRICE	CODE
No Brass Trim Option	N/C	NB
Non-Tufted Option	N/C	NT

### 4303 Sofa

78" W X 36" D X 28" H

St. Yardage: 11



Freight Class: 175  
 Cubic Ft: 71  
 Ship Weight: 165

Grade	1	2	3	4	5	6	7	8	9	10	L	LL
Zone 1	3333	3667	3964	4131	4387	4485	4898	5353	6079	6616	7042	7516
Zone 2	3383	3722	4023	4193	4453	4552	4971	5433	6170	6715	7148	7629
Zone 3	3433	3777	4083	4255	4519	4620	5045	5514	6261	6814	7253	7741

- Extra-deep seat comfort
- Deep-well tufting
- Puzzle-joint construction, wood frame
- See features in series overview above
- Seat: 64"W x 23.5"D x 18"H

OPTION	PRICE	CODE
No Brass Trim Option	N/C	NB
Non-Tufted Option	N/C	NT

# OCCASIONAL TABLES SIN 711-11

OCCASIONAL TABLES

## Malibu Collection



**Malibu** occasional tables blend classic materials, steel and glass, to provide unique accents in a wide range of environments. Bases are built with tapered steel legs. Choose glass or laminate top.

## Trados Metal Collection

**Trados Metal** occasional tables feature tubular steel base with a brushed aluminum powdercoat finish with a urethane clear coat. Choose glass or laminate top.



## Stratus Collection



**Stratus** coffee table features two curved laminate tops with 2" top spacers to create a floating top. Four anodized aluminum column legs.

## 6700 Collection

Tapered-leg occasional tables that blend harmoniously with traditional or modern interiors, **6700** tables are available with veneer or laminate tops.



## NexStep Collection



**NexStep** occasional tables bring dramatic style to any environment. Quarter-cut mahogany veneers are matched for unique pattern on tops.

## Hyperwork Collection

High-quality, high-value contemporary tables for fast-paced business environments. Angled satin finish chrome legs add visual interest.

## 9100 Collection

**9100** occasional tables feature veneer tops and the natural beauty of wood. Tops feature radius corners, ideal for waiting room environments

## 7400 Modular Collection



The **7400** two-tier base creates heavy-duty frame for long-term use. Recessed plinth bases reduce scuffs and feature a textured, black vinyl surface that resists scratches.

## Step Collection

**Steps** offers high-quality construction and durable, black textured finish. Tables feature radius corners, sensitive to waiting areas where children may frequent.

## Marquet Collection

**Marquet** table tops feature cherry, maple and walnut veneer in unique pattern influenced by traditional marquetry designs.



## Bedford Collection



**Bedford**, an occasional table collection of traditional designs, responds to the demands of the modern office. High pressure laminate top, 3/16" thick, has shaped edges.

## Malibu

### 5923MET End Table



- Round 3/8" thick clear glass top
- Tapered-leg steel base
- Brushed aluminum powdercoat finish with a urethane clear coat
- Protective floor caps

**QS** Freight Class: 250

### 5920MET Coffee Table



- Oval 3/8" thick clear glass top
- Tapered-leg steel base
- Brushed aluminum powdercoat finish with a urethane clear coat
- Protective floor caps

**QS** Freight Class: 250

Zone Pricing	1	2	3
28" X 28" X 24" Cubic Ft: 16 Ship Weight: 43	<b>710</b>	<b>721</b>	<b>731</b>
52" X 33" X 18.25" Cubic Ft: 26 Ship Weight: 79	<b>927</b>	<b>941</b>	<b>955</b>



# SIN 711-11 OCCASIONAL TABLES

OCCASIONAL TABLES

## 5927MET Sofa Table



- Demilune 3/8" thick clear glass top
- Tapered-leg steel base
- Brushed aluminum powdercoat finish with a urethane clear coat
- Protective floor caps

**QS** Freight Class: 250

## 5923\_ Round Table with Laminate Top and Metal Base



- Round 3/4" thick themally fused laminate top
- Tapered-leg steel base
- Brushed aluminum powdercoat finish with a urethane clear coat
- Quick Ship finish options: Natural Maple, Windsor Cherry, Aspen, Black and Mahogany
- Protective floor caps

**QS** Freight Class: 250

## 5920\_ Coffee Table with Laminate Top and Metal Base



- Oval 3/4" thick themally fused laminate top
- Tapered-leg steel base
- Brushed aluminum powdercoat finish with a urethane clear coat
- Quick Ship finish options: Natural Maple, Windsor Cherry, Aspen, Black and Mahogany
- Protective floor caps

**QS** Freight Class: 250

## 5927\_ Sofa Table with Laminate Top and Metal base

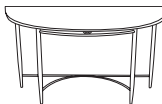

- Demilune 3/4" thick themally fused laminate top
- Tapered-leg steel base
- Brushed aluminum powdercoat finish with a urethane clear coat
- Quick Ship finish options: Natural Maple, Windsor Cherry, Aspen, Black and Mahogany
- Protective floor caps

**QS** Freight Class: 250

## Trados Metal

### 5723MET End Table, Metal Base and Glass Top

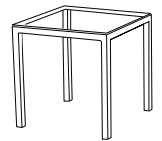

- .375" clear glass top
- 1.5" square tubular steel frame
- 1.5" x .5" tubular steel apron top support
- Brushed aluminum powdercoat finish with a urethane clear coat
- Aluminum finish coordinates with Trados Metal seating
- Protective floor caps

**QS** Freight Class: 250

### 5720MET Coffee Table, Metal Base and Glass Top

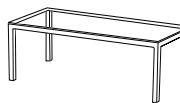

- .375" clear glass top
- 1.5" square tubular steel frame
- 1.5" x .5" tubular steel apron top support
- Brushed aluminum powdercoat finish with a urethane clear coat
- Aluminum finish coordinates with Trados Metal seating
- Protective floor caps

**QS** Freight Class: 250

	Zone Pricing	1	2	3
54" X 19" X 28.5" Cubic Ft: 27 Ship Weight: 64		1051	1067	1083
28" X 28" X 24" Cubic Ft: 16 Ship Weight: 36		880	893	906
Finish Options: Natural Maple (FM), Windsor Cherry (WC), Mahogany (M), Graphite (GP), Medium Oak (O), Aspen (AP), Pearwood (PW), Black (E), Espresso (X), Grey (G) and Classic Cherry (CC)				
52" X 33" X 18.25" Cubic Ft: 27 Ship Weight: 64		1351	1371	1392
Finish Options: Natural Maple (FM), Windsor Cherry (WC), Mahogany (M), Graphite (GP), Medium Oak (O), Aspen (AP), Pearwood (PW), Black (E), Espresso (X), Grey (G) and Classic Cherry (CC)				
54" X 19" X 28.25" Cubic Ft: 27 Ship Weight: 47		1220	1238	1257
Finish Options: Natural Maple (FM), Windsor Cherry (WC), Mahogany (M), Graphite (GP), Medium Oak (O), Aspen (AP), Pearwood (PW), Black (E), Espresso (X), Grey (G) and Classic Cherry (CC)				
25.5" X 25.5" X 25" Cubic Ft: 16 Ship Weight: 50		728	739	750
49.5" X 25.5" X 19" Cubic Ft: 25 Ship Weight: 76		949	963	978

# OCCASIONAL TABLES SIN 711-11

OCCASIONAL TABLES

## 5727MET Sofa Table, Metal Base and Glass Top

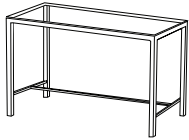

- .375" clear glass top
- 1.5" square tubular steel frame
- 1.5" x .5" tubular steel apron top support
- Brushed aluminum powdercoat finish with a urethane clear coat
- Aluminum finish coordinates with Trados Metal seating
- Protective floor caps

**QS** Freight Class: 250

	Zone Pricing	1	2	3
55.5" X 19.5" X 31" Cubic Ft: 26 Ship Weight: 77		<b>1076</b>	<b>1092</b>	<b>1109</b>

## 5723\_ End Table, Metal Base and Laminate Top

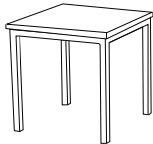

Freight Class: 250

**QS**

- 1" thick themally fused laminate top
- 1.5" square tubular steel frame
- 1.5" x .5" tubular steel apron top support
- Brushed aluminum powdercoat finish with a urethane clear coat
- Aluminum finish coordinates with Trados Metal seating
- Protective floor caps

25.5" X 25.5" X 25" Cubic Ft: 16 Ship Weight: 50		<b>728</b>	<b>739</b>	<b>750</b>
--	--	------------	------------	------------

Finish Options: Natural Maple (FM), Windsor Cherry (WC), Mahogany (M), Graphite (GP), Medium Oak (O), Aspen (AP), Pearwood (PW), Black (E), Espresso (X), Grey (G) and Classic Cherry (CC)

Quick Ship Finishes: Natural Maple (FM), Black (E),

## 5720\_ Coffee Table with Laminate Top and Metal Base

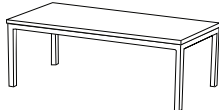

Freight Class: 250

**QS**

- 1" thick themally fused laminate top
- 1.5" square tubular steel frame
- 1.5" x .5" tubular steel apron top support
- Brushed aluminum powdercoat finish with a urethane clear coat
- Aluminum finish coordinates with Trados Metal seating
- Protective floor caps

49.5" X 25.5" X 19" Cubic Ft: 25 Ship Weight: 76		<b>949</b>	<b>963</b>	<b>978</b>
--	--	------------	------------	------------

Finish Options: Natural Maple (FM), Windsor Cherry (WC), Mahogany (M), Graphite (GP), Medium Oak (O), Aspen (AP), Pearwood (PW), Black (E), Espresso (X), Grey (G) and Classic Cherry (CC)

Quick Ship Finishes: Natural Maple (FM), Black (E),

## 5727\_ Sofa Table with Laminate Top and Metal base

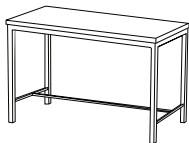

Freight Class: 250

**QS**

- 1" thick themally fused laminate top
- 1.5" square tubular steel frame
- 1.5" x .5" tubular steel apron top support
- Brushed aluminum powdercoat finish with a urethane clear coat
- Aluminum finish coordinates with Trados Metal seating
- Protective floor caps

55.5" X 19.5" X 31" Cubic Ft: 26 Ship Weight: 77		<b>1076</b>	<b>1092</b>	<b>1109</b>
--	--	-------------	-------------	-------------

Finish Options: Natural Maple (FM), Windsor Cherry (WC), Mahogany (M), Graphite (GP), Medium Oak (O), Aspen (AP), Pearwood (PW), Black (E), Espresso (X), Grey (G) and Classic Cherry (CC)

Quick Ship Finishes: Natural Maple (FM), Black (E),

## Stratus

### S\_CT20 Curved Coffee Table with Floating Tops

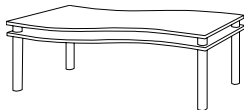

Freight Class: 250

- Two curved 3/4" thick themally fused laminate tops
- Four anodized aluminum top spacers for a floating top appearance
- Four anodized aluminum column legs with floor protecting glides
- Available in all Stratus finishes
- Can be ordered with tops in different finishes; must indicate finish for each top

48" X 24" X 16" Cubic Ft: 21.4 Ship Weight: 43		<b>1576</b>	<b>1600</b>	<b>1623</b>
--	--	-------------	-------------	-------------

# SIN 711-11 OCCASIONAL TABLES

OCCASIONAL TABLES

## 6700 Series

Zone Pricing

1

2

3

### 6720 Cocktail Table, Wood Veneer Top

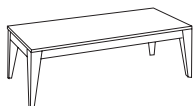

- Solid hardwood legs
- Veneer top
- Available in all seating finishes
- Assembly required

54" X 24" X 16" Cubic Ft: 5 Ship Weight: 55 **1034** **1050** **1065**

**QS** Freight Class: 85

### 6730 Cocktail Table, Laminate Top

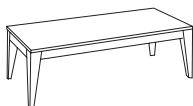

- Solid hardwood legs
- TFL top with AdvantEdge banding
- Assembly required

54" X 24" X 16" Cubic Ft: 5 Ship Weight: 65 **1024** **1039** **1055**

Finish Options: Natural Maple (FM) and Windsor Cherry

**QS** Freight Class: 85

### 6723 End Table, Wood Veneer Top

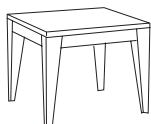

- Solid hardwood legs
- Veneer top
- Available in all seating finishes
- Assembly required

24" X 28" X 20" Cubic Ft: 3 Ship Weight: 40 **768** **780** **791**

**QS** Freight Class: 85

### 6733 End Table, Laminate Top

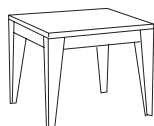

- Solid hardwood legs
- TFL top with AdvantEdge banding

24" X 28" X 20" Cubic Ft: 3 Ship Weight: 40 **760** **771** **783**

Finish Options: Natural Maple (FM) and Windsor Cherry

**QS** Freight Class: 85

## NexStep

### 790 Cocktail Table

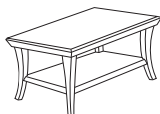

- Extra thick beveled edge
- Veneer inlay design (top)
- Veneer shelf under top
- Curved wood legs
- Assembly required

47.25" X 23.5" X 18" Cubic Ft: 5 Ship Weight: 46 **774** **786** **797**

Finish Options: Mahogany (MAH) and Walnut (WAL)

**QS** Freight Class: 100

### 793 End Table



- Extra thick beveled edge
- Veneer inlay design (top)
- Veneer shelf under top
- Curved wood legs
- Assembly required

22" X 22" X 21" Cubic Ft: 4 Ship Weight: 30 **585** **594** **603**

Finish Options: Mahogany (MAH) and Walnut (WAL)

**QS** Freight Class: 125

# OCCASIONAL TABLES SIN 711-11

OCCASIONAL TABLES

## Hyperwork

Zone Pricing

1

2

3

### HW\_CT48 Coffee Table

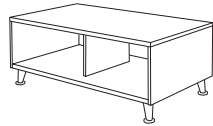

- Open storage/display shelf and top
- Angled satin finish chrome legs with stationary feet to match Claudia Series
- Ships fully assembled

Freight Class: 150

48" X 24" X 18" Cubic Ft: 11.9 Ship Weight: 96

681

691

701

Finish Options: Natural Maple (FM), Windsor Cherry (WC), Mahogany (M), Graphite (GP), Medium Oak (O), Aspen (AP), Pearwood (PW), Black (E), Espresso (X), Grey (G) and Classic Cherry (CC)

### HW\_ET18 End Table

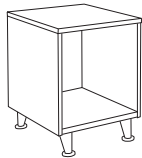

- Open storage/display shelf and top
- Angled satin finish chrome legs with stationary feet to match Claudia Series
- Ships fully assembled

Freight Class: 150

18" X 22" X 24" Cubic Ft: 6.9 Ship Weight: 50

529

537

545

Finish Options: Natural Maple (FM), Windsor Cherry (WC), Mahogany (M), Graphite (GP), Medium Oak (O), Aspen (AP), Pearwood (PW), Black (E), Espresso (X), Grey (G) and Classic Cherry (CC)

### HW\_ET23 End Table

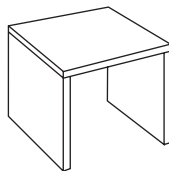

- Multiple uses
- Quick Ship in Windsor Cherry
- Assembly required

QS Freight Class: 85

22" X 24" X 18" Cubic Ft: 2.1 Ship Weight: 30

297

301

306

Finish Options: Natural Maple (FM), Windsor Cherry (WC), Mahogany (M), Graphite (GP), Medium Oak (O), Aspen (AP), Pearwood (PW), Black (E), Espresso (X), Grey (G) and Classic Cherry (CC)

### HW\_CT20 Coffee Table

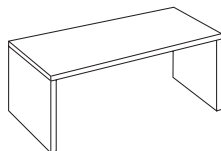

- Multiple uses
- Quick Ship in Windsor Cherry
- Assembly required

QS Freight Class: 85

48" X 24" X 15" Cubic Ft: 3.6 Ship Weight: 50

355

360

366

Finish Options: Natural Maple (FM), Windsor Cherry (WC), Mahogany (M), Graphite (GP), Medium Oak (O), Aspen (AP), Pearwood (PW), Black (E), Espresso (X), Grey (G) and Classic Cherry (CC)

## 9100 Series

### 9120 Cocktail Table

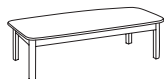

- Wood veneer top
- Solid hardwood legs
- Ships fully assembled

QS Freight Class: 150

54" X 24" X 16.5" Cubic Ft: 16 Ship Weight: 65

1001

1016

1031

Finish Options: Available in all seating finishes except Natural (FM), Medium Oak (OAK) and Natural Oak (NOK)

### 9123 End Table

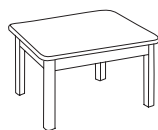

- Wood veneer top
- Solid hardwood legs
- Ships fully assembled

QS Freight Class: 150

24" X 28" X 20.25" Cubic Ft: 9 Ship Weight: 40

719

730

741

Finish Options: Available in all seating finishes except Natural (FM), Medium Oak (OAK) and Natural Oak (NOK)

# SIN 711-11 OCCASIONAL TABLES

OCCASIONAL TABLES

## 7400 Series

Zone Pricing

1

2

3

### 7420 Coffee Table



- Freestanding
- High pressure laminate top and sides in Grey, Windsor Cherry (WC) or Natural Maple (FM)
- Black recessed plinth base with a textured vinyl surface

Freight Class: 150

52" X 20" X 14"	Cubic Ft: 16	Ship Weight: 79	<b>825</b>	<b>837</b>	<b>850</b>
OPTION	PRICE	CODE			
Custom Laminate 7420	133.00	S			

### 7421 Cylinder Table

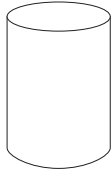

- Freestanding
- High pressure laminate top and sides in Grey, Windsor Cherry (WC) or Natural Maple (FM)

Freight Class: 150

19" X 14"	Cubic Ft: 6	Ship Weight: 29	<b>663</b>	<b>673</b>	<b>683</b>
OPTION	PRICE	CODE			
Custom Laminate 7421	133.00	S			

### 7423 End Table

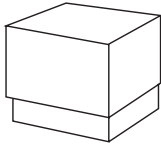

- Freestanding
- High pressure laminate top and sides in Grey, Windsor Cherry WC or Natural Maple FM
- Black recessed plinth base

Freight Class: 150

25" X 25" X 14"	Cubic Ft: 10	Ship Weight: 54	<b>716</b>	<b>727</b>	<b>737</b>
OPTION	PRICE	CODE			
Custom Laminate 7423	133.00	S			

### 7424 Connector Table

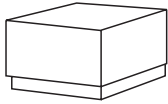

- Freestanding or connect to other units
- High pressure laminate top and sides in Grey, Windsor Cherry WC or Natural Maple FM
- Black recessed plinth base

Freight Class: 125

18" X 25" X 11.5"	Cubic Ft: 6	Ship Weight: 38	<b>644</b>	<b>654</b>	<b>663</b>
OPTION	PRICE	CODE			
Custom Laminate 7424	133.00	S			

### 7425 Wedge Table

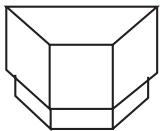

- 45° shape
- Connect to other units to form curves in layout
- High pressure laminate top and sides in Grey, Windsor Cherry WC or Natural Maple FM
- Black recessed plinth base

Freight Class: 125

8"/27" X 25" X 11.5"	Cubic Ft: 6	Ship Weight: 38	<b>800</b>	<b>812</b>	<b>824</b>
OPTION	PRICE	CODE			
Custom Laminate 7425	133.00	S			

### 7426 Corner Table

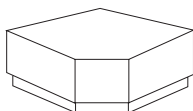

- Freestanding or connect to other units
- High pressure laminate top and sides in Grey, Windsor Cherry WC or Natural Maple FM
- Black recessed plinth base

Freight Class: 150

38" X 38" X 11.5"	Cubic Ft: 16	Ship Weight: 80	<b>906</b>	<b>920</b>	<b>933</b>
OPTION	PRICE	CODE			
Custom Laminate 7426	133.00	S			

# OCCASIONAL TABLES SIN 711-11

OCCASIONAL TABLES

## Steps Black Base

Zone Pricing

1

2

3

### 7420BLK Coffee Table



- Freestanding, multi-use table
- Full-to-floor black texture finish
- Matches Steps-Black Bases

52" X 20" X 14"    Cubic Ft: 16    Ship Weight: 75    **673**    **683**    **693**

**QS** Freight Class: 150

### 7423BLK End Table

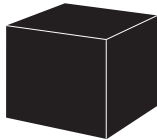

- Freestanding, multi-use table
- Full-to-floor black texture finish
- Matches Steps-Black Bases

25" X 25" X 14"    Cubic Ft: 10    Ship Weight: 50    **550**    **558**    **567**

**QS** Freight Class: 150

### 7424BLK Connecting Table



- Connecting or freestanding table
- Full-to-floor black texture finish
- Matches Steps-Black Bases

18" X 25" X 11.5"    Cubic Ft: 6    Ship Weight: 36    **489**    **496**    **504**

**QS** Freight Class: 150

### 7425BLK Wedge Table



- 45° shape table
- Connect to other units to form curves in layout
- Full-to-floor black texture finish
- Matches Steps-Black Bases

8"/27" X 24" X 11.5"    Cubic Ft: 6    Ship Weight: 37    **550**    **558**    **567**

**QS** Freight Class: 125

### 7426BLK Corner Table

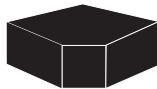

- Connecting or freestanding table
- Full-to-floor black texture finish
- Matches Steps Black bases

38" X 38" X 11.5"    Cubic Ft: 16    Ship Weight: 77    **806**    **818**    **830**

**QS** Freight Class: 150

## Marquet

### VT\_100 End Table

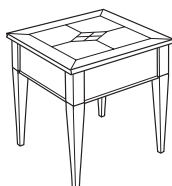

- Marquetry design
- Cherry, Maple and Walnut veneers cut and spliced in unique pattern
- Full fill, catalyzed lacquer finish
- Concave edge profile
- Fluted legs
- Some assembly required

21.75" X 21.75" X 20.75"    Cubic Ft: 3.5    Ship Weight: 29    **934**    **948**    **962**

Finish Options: Honey Cherry (H) or Rouge Mahogany (M)

**QS** Freight Class: 125



# SIN 711-11 OCCASIONAL TABLES

OCCASIONAL TABLES

## VT\_110 Coffee Table

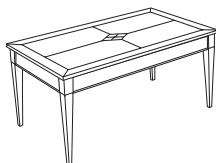

- Marquetry design
- Cherry, Maple and Walnut veneers cut and spliced in unique pattern
- Full fill, catalyzed lacquer finish
- Concave edge profile
- Fluted legs
- Some assembly required

**QS** Freight Class: 125

		Zone Pricing	1	2	3
47.25" X 27" X 20.75"	Cubic Ft: 7.6 Ship Weight: 50		<b>1224</b>	<b>1242</b>	<b>1261</b>
Finish Options: Honey Cherry (H) or Rouge Mahogany (M)					

## VT\_120 Console/Sofa Table

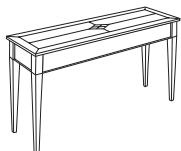

- Marquetry design
- Cherry, Maple and Walnut veneers cut and spliced in unique pattern
- Full fill, catalyzed lacquer finish
- Concave edge profile
- Fluted legs
- Full fill, catalyzed lacquer finish
- Some assembly required

**QS** Freight Class: 125

58.75" X 17.25" X 29.25"	Cubic Ft: 8.3 Ship Weight: 54		<b>1402</b>	<b>1423</b>	<b>1444</b>
Finish Options: Honey Cherry (H) or Rouge Mahogany (M)					

## Bedford

### TR\_4020 Traditional Cocktail Table

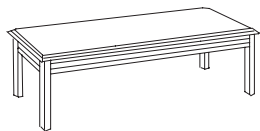

- High-gloss, high pressure laminate top in Mahogany and Windsor Cherry
- Shaped edges
- Ships unassembled, easy assembly

Freight Class: 100

54" X 24" X 16"	Cubic Ft: 5.5 Ship Weight: 69.5		<b>748</b>	<b>759</b>	<b>770</b>
Finish Options: Mahogany (M), Windsor Cherry (WC) and Oak (O) Note: Oak finish has a satin laminate top.					

### TR\_4023 Traditional End Table

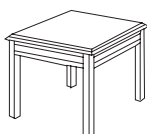

- High-gloss, high pressure laminate top in Mahogany and Windsor Cherry
- Shaped edges
- Ships unassembled, easy assembly

Freight Class: 92.5

22" X 27" X 18"	Cubic Ft: 2.5 Ship Weight: 38		<b>618</b>	<b>627</b>	<b>637</b>
Finish Options: Mahogany (M), Windsor Cherry (WC) and Oak (O) Note: Oak finish has a satin laminate top.					

# HIGH STREET SIN 711-17

GANGING

## A Soft Touch

No one enjoys waiting, but **High Street** ganged lounge seating might just make you look at your watch a little less often.

The fully upholstered design offers visitors a comfortably soft touch on every surface.



850-22 Two Seat

## High Street Features

- Four unique arm and back profiles available with or without center legs
- Open air design facilitates easy cleaning
- Wall-saver profile to reduce wear and tear
- Bariatric seating available
- Complementary guest seating available in HPFI HiLeg series

## Options Available

- Glider option may be added to any single or multi-seat unit with center legs
- Two color upholstery combinations available

## PROFILE DETAIL

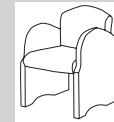

850 Radius Arm/  
Radius Back

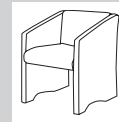

860 Slant Arm/  
Straight Back

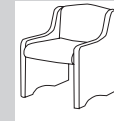

870 Low Arm/  
Camel Back

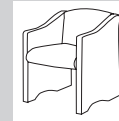

880 Slope Arm/  
Camel Back



861 High Back



850-25  
Two Seat

## 8\_-22 Two Seat

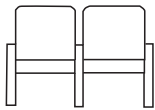

Freight Class: 250  
Cubic Ft: 41  
Ship Weight: 118

47" W X 27.5" D X 33.5" H St. Yardage: 8.25

Grade	1	2	3	4	5	6	7	8	9	10	L	LL
Zone 1	1684	1832	1981	2110	2244	2424	2493	2783	2962	3186	3714	4321
Zone 2	1709	1859	2011	2142	2278	2460	2530	2825	3006	3234	3770	4386
Zone 3	1735	1887	2040	2173	2311	2497	2568	2866	3051	3282	3825	4451

- Two chairs ganged
- Center leg
- Motion seat & back glider option available, see next page
- Each seat: 20.25"W x 20"D x 20"H

OPTION	PRICE	CODE
Softer Seat Foam-Loveseat	32.00	SF

## QS

## 8\_-25 Two Seat

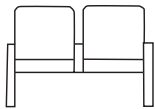

Freight Class: 250  
Cubic Ft: 41  
Ship Weight: 112

47" W X 27.5" D X 33.5" H St. Yardage: 7.75

Grade	1	2	3	4	5	6	7	8	9	10	L	LL
Zone 1	1796	1933	2072	2209	2339	2513	2581	2861	3035	3253	3668	4444
Zone 2	1823	1962	2103	2242	2374	2551	2620	2904	3081	3302	3723	4511
Zone 3	1850	1991	2134	2275	2409	2588	2658	2947	3126	3351	3778	4577

- Two chairs ganged
- Reinforced seat
- No center leg
- Each Seat: 20.25"W x 20"D x 20"H

OPTION	PRICE	CODE
Softer Seat Foam-Loveseat	32.00	SF

## QS

## 8\_-33 Three Seat

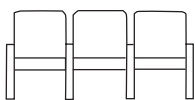

Freight Class: 300  
Cubic Ft: 76  
Ship Weight: 157

69" W X 27.5" D X 33.5" H St. Yardage: 11.5

Grade	1	2	3	4	5	6	7	8	9	10	L	LL
Zone 1	2335	2553	2771	2929	3116	3366	3463	3866	4116	4429	5301	6129
Zone 2	2370	2591	2813	2973	3163	3416	3515	3924	4178	4495	5381	6221
Zone 3	2405	2630	2854	3017	3209	3467	3567	3982	4239	4562	5460	6313

- Three chairs ganged
- Two center legs
- Motion seat & back glider option available, see next page
- Each Seat: 20.25"W x 20"D x 20"H

OPTION	PRICE	CODE
Softer Seat Foam-Sofa	48.00	SF

## QS

**8\_-35 Three Seat**

69" W X 27.5" D X 33.5" H St. Yardage: 10.5

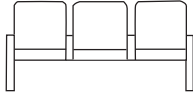

Freight Class: 300  
Cubic Ft: 76  
Ship Weight: 152

**QS**

Grade	1	2	3	4	5	6	7	8	9	10	L	LL
<b>Zone 1</b>	2448	2642	2837	3016	3195	3434	3527	3913	4152	4451	5101	6164
<b>Zone 2</b>	2485	2682	2880	3061	3243	3486	3580	3972	4214	4518	5178	6256
<b>Zone 3</b>	2521	2721	2922	3106	3291	3537	3633	4030	4277	4585	5254	6349

	OPTION	PRICE	CODE
• Three chairs ganged			
• Reinforced seat			
• No center legs			
• Each Seat: 20.25"W x 20"D x 20"H			
	Softer Seat Foam-Sofa	48.00	SF

**8\_-44 Four Seat**

91.5" W X 27.5" D X 33.5" H St. Yardage: 14.5

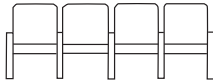

Freight Class: 300  
Cubic Ft: 89  
Ship Weight: 204

**QS**

Grade	1	2	3	4	5	6	7	8	9	10	L	LL
<b>Zone 1</b>	3009	3296	3582	3758	3994	4259	4431	4940	5255	5649	6911	7971
<b>Zone 2</b>	3054	3345	3636	3814	4054	4323	4497	5014	5334	5734	7015	8091
<b>Zone 3</b>	3099	3395	3689	3871	4114	4387	4564	5088	5413	5818	7118	8210

	OPTION	PRICE	CODE
• Four chairs ganged			
• Three center legs			
• Motion seat & back glider option available, see below			
• Each Seat: 20.25"W x 20"D x 20"H			
	Softer Seat Foam, 4 Seats	64.00	SF4

**8\_-45 Four Seat**

91.5" W X 27.5" D X 33.5" H St. Yardage: 13.75

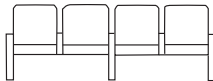

Freight Class: 250  
Cubic Ft: 89  
Ship Weight: 200

**QS**

Grade	1	2	3	4	5	6	7	8	9	10	L	LL
<b>Zone 1</b>	3234	3496	3761	3970	4202	4512	4632	5131	5441	5828	6564	8107
<b>Zone 2</b>	3283	3548	3817	4030	4265	4580	4701	5208	5523	5915	6662	8229
<b>Zone 3</b>	3331	3601	3874	4089	4328	4647	4771	5285	5604	6003	6761	8350

	OPTION	PRICE	CODE
• Four chairs ganged			
• One center leg			
• Reinforced seats			
• Each Seat: 20.25"W x 20"D x 20"H			
	Softer Seat Foam, 4 Seats	64.00	SF4

**---60 Motion Seat & Back Option**

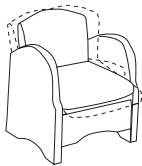

Freight Class: 250  
Cubic Ft: 89  
Ship Weight: 200

- Indicate glider location(s) for ganged units by adding A, B, C or D to the end of the model number
- Adds motion to any seat or seats
- Can be installed on full leg units only
- Price is per seat, add to the seating unit price

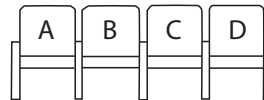

Zone Pricing	1	2	3
St. Yardage: 1	268	268	268

GANGING

### Maximum Comfort

The **Corbel** collection features a graceful curved arm design with a solid wood frame. All seating units, corner and connecting tables can be ganged in a virtually unlimited number of combinations.



993 Arm Chair

### Corbel Ganging Details

- *Chair-to-Chair ganging maximizes seating capacity*
- *Ganging Tables for lobbies, lounges and waiting areas*
- *Ganging Brackets sold separately*

### Chair & Table Details

- *Hardwood chair frames*
- *Post formed soft-rounded edges on tables*
- *Tops and legs are 1 1/8" thick core surfaced in high-pressure laminate*



### 992 Armless Stacking/Ganging Side Chair

22" W X 25" D X 34" H

St. Yardage: 1



Freight Class: 250

Cubic Ft: 15

Ship Weight: 48

Grade	1	2	3	4	5	6	7	8	9	10	L	LL
Zone 1	577	610	645	662	689	700	721	743	771	805	1007	1122
Zone 2	586	619	655	672	699	711	732	754	783	817	1022	1139
Zone 3	594	628	664	682	710	721	743	765	794	829	1037	1156

- Hardwood frame
- Stacks 5 high
- Ships 2 per carton; list price is for single chair
- Each chair adds 5.5" when stacking
- Seat: 19"W x 20"D x 19"H

Single Pack Specifications:  
 Freight Class: 300  
 Cubes: 14  
 Ship Wt.: 27

**QS**

### 993 Stacking/Ganging Guest Chair

22" W X 25" D X 34" H

St. Yardage: 1



Freight Class: 250

Cubic Ft: 15

Ship Weight: 48

Grade	1	2	3	4	5	6	7	8	9	10	L	LL
Zone 1	577	610	645	662	689	700	721	743	771	805	1007	1122
Zone 2	586	619	655	672	699	711	732	754	783	817	1022	1139
Zone 3	594	628	664	682	710	721	743	765	794	829	1037	1156

- Hardwood frame
- Stacks 5 high
- Ships 2 per carton; list price is for single chair
- Each chair adds 5.5" when stacking
- Seat: 19"W x 20"D x 19"H

Single Pack Specifications:  
 Freight Class: 300  
 Cubes: 14  
 Ship Wt.: 27

**QS**

### 9923 End Table (Table Only)

20" W X 17" D X 16" H

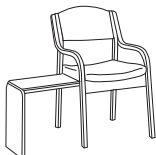

Freight Class: 250

Cubic Ft: 15

Ship Weight: 48

- Tops and legs are 1-1/8 thick core surfaced in high pressure laminate
- Post formed soft-rounded edges
- Table and bracket include
- Available in finishes listed above

Zone Pricing	1	2	3
St. Yardage: n/a	424	430	437

**QS**

FINISH SELECTION

MAHOGANY **MAH** | NATURAL OAK **NOK** | MEDIUM OAK **OAK** | WINDSOR CHERRY **WC**

SIN 711-17 **CORBEL**

**9924 Connecting Table (Table Only)**

26" W X 16" D X 16" H

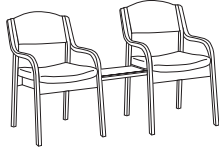

Freight Class: 100  
Cubic Ft: 2  
Ship Weight: 17

- Tops are 1-1/8 thick core surfaced in high pressure laminate
- Post formed soft-rounded edges
- Table and bracket included
- Available in finishes listed above

**QS**

**9926 Corner Table (Table Only)**

29.5" W X 29.5" D X 15.5" H

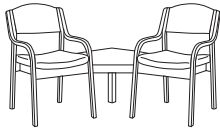

Freight Class: 100  
Cubic Ft: 2  
Ship Weight: 17

- Tops and legs are 1-1/8 thick core surfaced in high pressure laminate
- Post formed soft-rounded edges
- Table and bracket included
- Available in finishes listed above
- Assembly required

**QS**

**99B Chair-to-Chair Ganging Bracket**

8" W X 8" D X 2" H



Freight Class: 100  
Cubic Ft: 2  
Ship Weight: 17

- 11 gauge steel Black powder coated
- Connects chairs
- Need one bracket in each chair-to-chair connection

Zone Pricing	1	2	3
St. Yardage: n/a	<b>219</b>	<b>222</b>	<b>226</b>
St. Yardage: n/a	<b>517</b>	<b>525</b>	<b>533</b>
St. Yardage: n/a	<b>42</b>	<b>43</b>	<b>43</b>

GANGING

# SCOOP SIN 711-17

## FINISH SELECTION

ASPEN **AP** | BLACK **BLK** | NATURAL **FM** | HONEY CHERRY **HCY** | MAHOGANY **MAH** |  
 MOAB **MOB** | MEDIUM OAK **OAK** | NATURAL OAK **NOK** | PEARWOOD **PW** | WALNUT  
**WAL** | WINDSOR CHERRY **WC** | CLASSIC CHERRY **CCY** | ESPRESSO **ESP** |

GANGING

### Solid Good Looks

The **Scoop** collection has solid good looks and two upholstery style options. All seating units, corner and connecting tables can be ganged and configured in a virtually unlimited number of combinations.



**1003CCC ganged configuration with plain back**

### Scoop Ganging Details

- *Chair base choices: Sled base or Four legged*
- *Upholstery stitching choices: plain back or channel back*
- *Connecting table available*
- *Priced per chair*

### Ordering Information

**Ganging orders are priced per chair**

For each ganged chair, add a **C** to the product number; multiply the number of seats by the correct list price.

**Example:**

1003CCC (3 chairs with four-legged base)

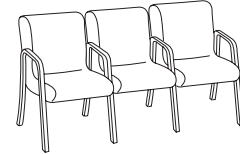

### 1003 Arm Chair



Freight Class: 250  
 Cubic Ft: 15  
 Ship Weight: 31

24" W X 27" D X 33" H

St. Yardage: 2

Grade	1	2	3	4	5	6	7	8	9	10	L	LL
<b>Zone 1</b>	561	620	671	697	740	757	827	871	925	1028	1142	1273
<b>Zone 2</b>	569	629	681	707	751	768	839	884	939	1043	1159	1292
<b>Zone 3</b>	578	639	691	718	762	780	852	897	953	1059	1176	1311

- Wood arms/legs
- Available in the finishes listed
- Gangable up to 4 chairs
- Seat: 20"W x 19"D x 18.5"H
- Price shown is per chair

Add a "C" to the product number for each ganged chair, and multiply number of chairs by correct list price. Ex: 1003CCC (3 chairs)

**QS**

### 1004 Sled Base Arm Chair



Freight Class: 250  
 Cubic Ft: 15  
 Ship Weight: 33

24" W X 28" D X 33" H

St. Yardage: 2

Grade	1	2	3	4	5	6	7	8	9	10	L	LL
<b>Zone 1</b>	620	677	691	723	756	799	816	886	930	984	1087	1332
<b>Zone 2</b>	629	687	701	734	767	811	828	899	944	999	1103	1352
<b>Zone 3</b>	639	697	712	745	779	823	840	913	958	1014	1120	1372

- Wood arms and sled base
- Available in the finishes listed
- Gangable up to 4 chairs
- Seat: 20"W x 19"D x 18.5"H
- Price shown is per chair

Add a "C" to the product number for each ganged chair, and multiply number of chairs by correct list price. Ex: 1004CCC (3 chairs)

**QS**

### T1005 Ganging Table (Table Only)

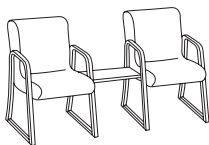

Freight Class: 70  
 Cubic Ft: 1  
 Ship Weight: 10

23" W X 15" D X 2" H

- Wood veneer table
- Can be shipped via ground service
- Available in the finishes listed above

Zone Pricing	1	2	3
St. Yardage: n/a	<b>189</b>	<b>192</b>	<b>195</b>

**QS**



**1113 Arm Chair**



Freight Class: 250  
Cubic Ft: 15  
Ship Weight: 31

24" W X 27" D X 33" H

St. Yardage: 2

Grade	1	2	3	4	5	6	7	8	9	10	L	LL
<b>Zone 1</b>	<b>566</b>	<b>599</b>	<b>637</b>	<b>669</b>	<b>702</b>	<b>745</b>	<b>762</b>	<b>832</b>	<b>876</b>	<b>930</b>	<b>1033</b>	<b>1254</b>
<b>Zone 2</b>	<b>574</b>	<b>608</b>	<b>647</b>	<b>679</b>	<b>713</b>	<b>756</b>	<b>773</b>	<b>844</b>	<b>889</b>	<b>944</b>	<b>1048</b>	<b>1273</b>
<b>Zone 3</b>	<b>583</b>	<b>617</b>	<b>656</b>	<b>689</b>	<b>723</b>	<b>767</b>	<b>785</b>	<b>857</b>	<b>902</b>	<b>958</b>	<b>1064</b>	<b>1292</b>

- Channel style back
- Wood arms/legs available in the finishes listed
- Gangable up to 4 chairs
- Seat: 20"W x 19"D x 18.5"H

Add a "C" to the product number for each ganged chair, and multiply number of chairs by correct list price. Ex: 1113CCC (3 chairs)

**QS**

**1114 Arm Chair**



Freight Class: 250  
Cubic Ft: 15  
Ship Weight: 33

24" W X 28" D X 33" H

St. Yardage: 2

Grade	1	2	3	4	5	6	7	8	9	10	L	LL
<b>Zone 1</b>	<b>626</b>	<b>682</b>	<b>697</b>	<b>729</b>	<b>762</b>	<b>805</b>	<b>822</b>	<b>892</b>	<b>936</b>	<b>990</b>	<b>1093</b>	<b>1312</b>
<b>Zone 2</b>	<b>635</b>	<b>692</b>	<b>707</b>	<b>740</b>	<b>773</b>	<b>817</b>	<b>834</b>	<b>905</b>	<b>950</b>	<b>1005</b>	<b>1109</b>	<b>1332</b>
<b>Zone 3</b>	<b>645</b>	<b>702</b>	<b>718</b>	<b>751</b>	<b>785</b>	<b>829</b>	<b>847</b>	<b>919</b>	<b>964</b>	<b>1020</b>	<b>1126</b>	<b>1351</b>

- Channel style back
- Wood arms and sled base
- Available in the finishes listed
- Gangable up to 4 chairs
- Price shown is per chair
- Seat: 20"W x 19"D x 18.5"H

Add a "C" to the product number for each ganged chair, and multiply number of chairs by correct list price. Ex: 1114CCC (3 chairs)

**QS**

**GANGING**

### Versatile & Popular

Versatile and popular, the **9118/9128** ganging collection offer extensive capability for a wide range of environments. Hardwood frames and quality construction are backed with Limited Lifetime Warranty. Select open arm or upholstered arm panel designs. Complement your offices with extensive finish and upholstery options.

### 9118/9128 Ganging Details

- *Chair-to-Chair ganging maximizes seating capacity*
- *Ganging Tables for lobbies, lounges and waiting areas*
- *Ganging Brackets sold separately*

### Chair & Table Details

- *Hardwood chair frames*
- *Post formed soft-rounded edges on tables*
- *Tops and legs are 1 1/8" thick core surfaced in high-pressure laminate*



**9118 Guest Chair**



**9128 Guest Chair**



### 9118 Arm Chair

23" W X 25.5" D X 33" H

St. Yardage: 2



Freight Class: 250  
Cubic Ft: 15  
Ship Weight: 26

Grade	1	2	3	4	5	6	7	8	9	10	L	LL
Zone 1	608	666	718	737	778	832	853	941	995	1063	1287	1498
Zone 2	617	676	729	748	790	844	866	955	1010	1079	1306	1520
Zone 3	626	686	740	759	801	857	879	969	1025	1095	1326	1543

- Hardwood frame
- Upholstered seat/back
- Available in all seating finishes
- Seat: 20.5"W x 17.25"D x 19"H

**QS**

### 9128 Arm Chair

23" W X 25.5" D X 33" H

St. Yardage: 2.5



Freight Class: 250  
Cubic Ft: 15  
Ship Weight: 29

Grade	1	2	3	4	5	6	7	8	9	10	L	LL
Zone 1	709	780	844	879	933	954	1042	1096	1164	1293	1560	1699
Zone 2	720	792	857	892	947	968	1058	1112	1181	1312	1583	1724
Zone 3	730	803	869	905	961	983	1073	1129	1199	1332	1607	1750

- Hardwood frame
- Upholstered seat/back
- Upholstered side panels
- Available in all seating finishes
- Seat: 20.5"W x 17.25"D x 19"H

**QS**

**9124 Connecting Table (Table Only)**

26" W X 16" D X 16" H

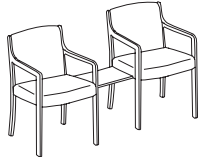

Freight Class: 100  
Cubic Ft: 2  
Ship Weight: 17

- Tops are 1-1/8 thick core surfaced in high pressure laminate
- Post formed soft-rounded edges
- Table and bracket included
- Available in Mahogany (MAH), Medium Oak (OAK), Natural Oak (NOK) and Windsor Cherry (WC) only

**QS**

**9126 Corner Table (Table Only)**

29.5" W X 29.5" D X 15.5" H

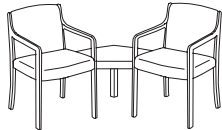

Freight Class: 150  
Cubic Ft: 6  
Ship Weight: 28

- Tops and legs are 1-1/8 thick core surfaced in high pressure laminate
- Post formed soft-rounded edges
- Table and bracket included
- Available in Mahogany (MAH), Medium Oak (OAK), Natural Oak (NOK) and Windsor Cherry (WC) only

**QS**

**9103 End Table (Table Only)**

20" W X 17" D X 16" H

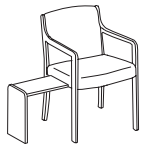

Freight Class: 250  
Cubic Ft: 7  
Ship Weight: 23

- Tops and legs are 1-1/8 thick core surfaced in high pressure laminate
- Post formed soft-rounded edges
- Table and bracket included
- Available in Mahogany (MAH), Medium Oak (OAK), Natural Oak (NOK) and Windsor Cherry (WC) only

**QS**

**9193CTC Ganging Bracket**

10" W X 3.5" D X 0.125" H

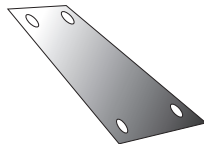

Freight Class: 70  
Cubic Ft: 0.2  
Ship Weight: 1

- 16 gauge steel
- Black powder coated
- Connect chairs
- Need one bracket in each chair-to-chair connection

Zone Pricing	1	2	3
St. Yardage: n/a	<b>216</b>	<b>219</b>	<b>222</b>
St. Yardage: n/a	<b>511</b>	<b>519</b>	<b>526</b>
St. Yardage: n/a	<b>418</b>	<b>424</b>	<b>431</b>
St. Yardage: n/a	<b>27</b>	<b>27</b>	<b>28</b>

GANGING

GANGING

### Ganging Seating: Solid Comfort

The **Unos** collection features a striking scalloped arm design in solid wood frame. All seating units, with Trados corner and connecting tables can be ganged in a virtually unlimited number of combinations.



### Chair Details

- Select 2, 3 or 4 seater ganged armchairs
- Clean out feature facilitates easy cleaning
- Reinforced seat frame

### Table Details

- Use Trados tables for ganging
- Sturdy 1" thick tops
- Corner table leg is 1 3/4" thick solid hard wood
- Table and bracket included

#### 904-2 Two Armchairs Ganged

47.5" W X 25" D X 35" H

St. Yardage: 5



Freight Class: 250  
Cubic Ft: 36  
Ship Weight: 85

Grade	1	2	3	4	5	6	7	8	9	10	L	LL
Zone 1	1522	1604	1699	1789	1873	1986	2098	2211	2323	2464	2704	3363
Zone 2	1545	1628	1724	1816	1901	2016	2129	2244	2358	2501	2745	3413
Zone 3	1568	1652	1750	1843	1929	2046	2161	2277	2393	2538	2785	3464

- Extra sturdy solid hardwood frames
- Transitional style 1.5" thick scalloped arms/legs
- Separated upholstered seat and back for easy cleanout
- Steel reinforced seat frames
- Weight capacity of 350 lbs each chair
- Each seat: 20"W x 19"D x 18"H

OPTION	PRICE	CODE
Black Polyurethane Arm Caps, 2 Chairs	129.00	PC3

**QS**

#### 904-3 Three Armchairs Ganged

70.5" W X 25" D X 35" H

St. Yardage: 7



Freight Class: 250  
Cubic Ft: 55  
Ship Weight: 124

Grade	1	2	3	4	5	6	7	8	9	10	L	LL
Zone 1	2283	2405	2548	2684	2810	2979	3147	3316	3485	3696	4056	5045
Zone 2	2317	2441	2586	2724	2852	3024	3194	3366	3537	3751	4117	5121
Zone 3	2351	2477	2624	2765	2894	3068	3241	3415	3590	3807	4178	5196

- Extra sturdy solid hardwood frames
- Transitional style 1.5" thick scalloped arms/legs
- Separated upholstered seat and back for easy cleanout
- Steel reinforced seat frames
- Weight capacity of 350 lbs each chair
- Each seat: 20"W x 19"D x 18"H

OPTION	PRICE	CODE
Black Polyurethane Arm Caps, 3 Chairs	172.00	PC4

**QS**

#### 904-4 Four Armchairs Ganged

93" W X 25" D X 35" H

St. Yardage: 9



Freight Class: 250  
Cubic Ft: 75  
Ship Weight: 158

Grade	1	2	3	4	5	6	7	8	9	10	L	LL
Zone 1	3044	3207	3397	3578	3747	3972	4197	4421	4646	4927	5408	6727
Zone 2	3090	3255	3448	3632	3803	4032	4260	4487	4716	5001	5489	6828
Zone 3	3135	3303	3499	3685	3859	4091	4323	4554	4785	5075	5570	6929

- Extra sturdy solid hardwood frames
- Transitional style 1.5" thick scalloped arms/legs
- Separated upholstered seat and back for easy cleanout
- Steel reinforced seat frames
- Weight capacity of 350 lbs each chair
- Each seat: 20"W x 19"D x 18"H

OPTION	PRICE	CODE
Black Polyurethane Arm Caps, 4 Chairs	215.00	PC5

**QS**

# FINISH SELECTION

ASPEN **AP** | BLACK **BLK** | HONEY CHERRY **HCY** | ROUGE MAHOGANY **RM** | MAHOGANY **MAH** | MOAB **MOB** | PEARWOOD **PW** | WALNUT **WAL** | WINDSOR CHERRY **WC** | CLASSIC CHERRY **CCY** | ESPRESSO **ESP** |

SIN 711-17 **TRADOS**

GANGING

## Ganging Seating: Solid Comfort

The **Trados** collection features a striking triarc arm design in solid wood or metal frame. All seating units, corner and connecting tables can be ganged in a virtually unlimited number of combinations.



914 Arm Chair

## Chair Details

- Select 2, 3 or 4 seater ganged armchairs
- Clean out feature facilitates easy cleaning
- Reinforced seat frame

## Table Details

- Corner Table & Connecting Table available
- Sturdy 1" thick tops
- Corner table leg is 1 3/4" thick solid hard wood
- Table and bracket included

## TRADOS GANGING ORDER DETAIL:



This **Trados Ganging** configuration consists of the following model numbers:

- 914-2 Two-seater Arm Chair
- 919 Corner Table
- 914 Arm Chair
- 917 Connecting Table
- 915 Highback Arm Chair

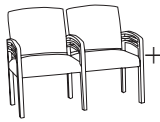

914-2



919



914



917



915

### 914-2 Two Armchairs Ganged

44.5" W X 25" D X 35" H

St. Yardage: 5

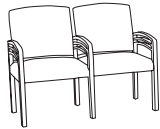

Freight Class: 250  
Cubic Ft: 36  
Ship Weight: 65

**QS**

Grade	1	2	3	4	5	6	7	8	9	10	L	LL
Zone 1	1397	1429	1460	1523	1580	1664	1748	1861	1973	2086	2179	2339
Zone 2	1418	1450	1482	1546	1604	1689	1774	1889	2003	2117	2212	2374
Zone 3	1439	1472	1504	1569	1627	1714	1800	1917	2032	2149	2244	2409

- Solid wood frame
- Triarc arm design
- Separated upholstered seat and back for easy cleanout
- Steel reinforced seat frame
- Weight capacity of 350 lbs per seat
- Ships assembled
- Each Seat: 20"W x 19"D x 18"H

OPTION	PRICE	CODE
Black Polyurethane Arm Caps, 2 Chairs Ganged	120.00	PC3

### 914-3 Three Armchairs Ganged

66.5" W X 25" D X 35" H

St. Yardage: 7

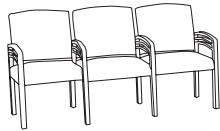

Freight Class: 300  
Cubic Ft: 55  
Ship Weight: 114

**QS**

Grade	1	2	3	4	5	6	7	8	9	10	L	LL
Zone 1	2096	2127	2158	2222	2370	2497	2623	2792	2960	3129	3228	3509
Zone 2	2127	2159	2190	2255	2409	2534	2662	2834	3004	3176	3276	3562
Zone 3	2159	2191	2223	2289	2441	2572	2702	2876	3049	3223	3325	3614

- Solid wood frame
- Triarc arm design
- Separated upholstered seat and back for easy cleanout
- Steel reinforced seat frame
- Weight capacity of 350 lbs per seat
- Ships assembled
- Each Seat: 20"W x 19"D x 18"H

OPTION	PRICE	CODE
Black Polyurethane Arm Caps, 3 Chairs Ganged	160.00	PC4

### 914-4 Four Armchairs Ganged

88" W X 25" D X 35" H

St. Yardage: 9

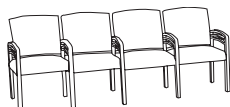

Freight Class: 400  
Cubic Ft: 75  
Ship Weight: 142

**QS**

Grade	1	2	3	4	5	6	7	8	9	10	L	LL
Zone 1	2794	2825	2857	2963	3159	3328	3497	3722	3947	4171	4276	4396
Zone 2	2836	2867	2900	3007	3206	3378	3549	3778	4006	4234	4340	4462
Zone 3	2878	2910	2943	3052	3254	3428	3602	3834	4065	4296	4404	4462

- Solid wood frame
- Triarc arm design
- Separated upholstered seat and back for easy cleanout
- Steel reinforced seat frame
- Weight capacity of 350 lbs per seat
- Ships assembled
- Each Seat: 20"W x 19"D x 18"H

OPTION	PRICE	CODE
Black Polyurethane Arm Caps, 4 Chairs Ganged	200.00	PC5

GANGING

### 917 Connecting Table (Table Only)

20" W X 21.5" D X 15.5" H



Freight Class: 125  
 Cubic Ft: 3  
 Ship Weight: 24

- Tops are 1" thick
- Solid hardwood top and rails
- Table and bracket included
- Available in finishes listed above plus FM Natural

Zone Pricing	1	2	3
St. Yardage: n/a	<b>441</b>	<b>448</b>	<b>454</b>

**QS**

### 919 Corner Table (Table Only)

28.25" W X 28.25" D X 15.5" H



Freight Class: 100  
 Cubic Ft: 4  
 Ship Weight: 36

- Tops are 1" thick
- Leg is 1-3/4" thick solid hardwood
- Solid hardwood top and rails
- Table and bracket included
- Available in finishes listed above plus FM Natural
- Assembly required

St. Yardage: n/a	<b>776</b>	<b>788</b>	<b>799</b>
------------------	------------	------------	------------

**QS**

### 914MET-2 Two Armchairs Ganged

44.5" W X 25" D X 35" H

St. Yardage: 5

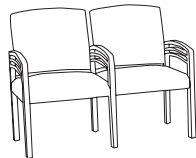

Freight Class: 300  
 Cubic Ft: 36  
 Ship Weight: 85

Grade	1	2	3	4	5	6	7	8	9	10	L	LL
<b>Zone 1</b>	<b>1600</b>	<b>1691</b>	<b>1798</b>	<b>1867</b>	<b>1951</b>	<b>2064</b>	<b>2176</b>	<b>2289</b>	<b>2401</b>	<b>2542</b>	<b>2922</b>	<b>3441</b>
<b>Zone 2</b>	<b>1624</b>	<b>1716</b>	<b>1825</b>	<b>1895</b>	<b>1980</b>	<b>2095</b>	<b>2209</b>	<b>2323</b>	<b>2437</b>	<b>2580</b>	<b>2966</b>	<b>3493</b>
<b>Zone 3</b>	<b>1648</b>	<b>1742</b>	<b>1852</b>	<b>1923</b>	<b>2010</b>	<b>2126</b>	<b>2241</b>	<b>2358</b>	<b>2473</b>	<b>2618</b>	<b>3010</b>	<b>3544</b>

- Metal Triarc arms/legs
- Separated upholstered seat and back for easy cleanout
- Steel reinforced seat frame
- Weight capacity of 350 lbs per seat
- Optional wood armd caps available in all seating finishes except OAK and NOK
- Ships assembled
- Each Seat: 20"W x 19"D x 18"H

OPTION	PRICE	CODE
Black Polyurethane Arm Caps, 2 Chairs Ganged	120.00	PC3
Wood Arm Cap, 2 Chairs Ganged	120.00	WA3

**QS**

### 914MET-3 Three Armchairs Ganged

66.5" W X 25" D X 35" H

St. Yardage: 7

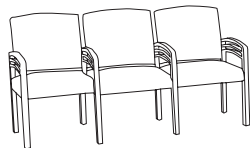

Freight Class: 300  
 Cubic Ft: 56  
 Ship Weight: 129

Grade	1	2	3	4	5	6	7	8	9	10	L	LL
<b>Zone 1</b>	<b>2401</b>	<b>2538</b>	<b>2697</b>	<b>2802</b>	<b>2928</b>	<b>3097</b>	<b>3265</b>	<b>3434</b>	<b>3603</b>	<b>3814</b>	<b>4384</b>	<b>5163</b>
<b>Zone 2</b>	<b>2437</b>	<b>2576</b>	<b>2737</b>	<b>2844</b>	<b>2972</b>	<b>3143</b>	<b>3314</b>	<b>3486</b>	<b>3657</b>	<b>3871</b>	<b>4450</b>	<b>5240</b>
<b>Zone 3</b>	<b>2473</b>	<b>2614</b>	<b>2778</b>	<b>2886</b>	<b>3016</b>	<b>3190</b>	<b>3363</b>	<b>3537</b>	<b>3711</b>	<b>3928</b>	<b>4516</b>	<b>5318</b>

- Metal Triarc arms/legs
- Separated upholstered seat and back for easy cleanout
- Steel reinforced seat frame
- Weight capacity of 350 lbs per seat
- Optional wood armd caps available in all seating finishes except OAK and NOK
- Ships assembled
- Each Seat: 20"W x 19"D x 18"H

OPTION	PRICE	CODE
Black Polyurethane Arm Caps, 3 Chairs Ganged	160.00	PC4
Wood Arm Cap, 3 Chairs Ganged	160.00	WA4

**QS**

### 914MET-4 Four Armchairs Ganged

88" W X 25" D X 35" H

St. Yardage: 9

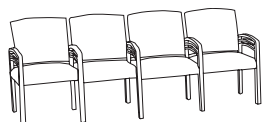

Freight Class: 300  
 Cubic Ft: 75  
 Ship Weight: 169

Grade	1	2	3	4	5	6	7	8	9	10	L	LL
<b>Zone 1</b>	<b>3201</b>	<b>3384</b>	<b>3597</b>	<b>3735</b>	<b>3904</b>	<b>4129</b>	<b>4354</b>	<b>4578</b>	<b>4803</b>	<b>5084</b>	<b>5846</b>	<b>6884</b>
<b>Zone 2</b>	<b>3249</b>	<b>3435</b>	<b>3651</b>	<b>3791</b>	<b>3963</b>	<b>4191</b>	<b>4419</b>	<b>4647</b>	<b>4875</b>	<b>5160</b>	<b>5934</b>	<b>6987</b>
<b>Zone 3</b>	<b>3297</b>	<b>3486</b>	<b>3705</b>	<b>3847</b>	<b>4021</b>	<b>4253</b>	<b>4485</b>	<b>4715</b>	<b>4947</b>	<b>5237</b>	<b>6021</b>	<b>7091</b>

- Metal Triarc arms/legs
- Separated upholstered seat and back for easy cleanout
- Steel reinforced seat frame
- Weight capacity of 350 lbs per seat
- Optional wood armd caps available in all seating finishes except OAK and NOK
- Ships assembled
- Each Seat: 20"W x 19"D x 18"H

OPTION	PRICE	CODE
Black Polyurethane Arm Caps, 4 Chairs Ganged	200.00	PC5
Wood Arm Cap, 4 Chairs Ganged	200.00	WA5







## Environmental and Sustainability Efforts

For more than 50 years, HPFI® (High Point Furniture Industries) has been building furniture in the United States with respect to our environment and our community. As a world-class manufacturing operation, we strive to reduce and eliminate our impact on the environment. We recycle and reuse wherever possible. When viable and acceptable to our customers, we incorporate recycled and recyclable materials into our finished products.

HPFI is utilizing the Business and Institutional Furniture Manufacturer's Association's (BIFMA) e3 standard to identify and certify the levels of environmental achievement as well as identify specific contributions of LEED points. All HPFI products are (Gold) level II and tested to the BIFMA X7.1 Furniture Emissions Standard.

As a manufacturer of wood products, we recognize that our materials come from natural resources, which must be respected. Supplier partners are suggested to hold this same respect in harvesting and processing natural resources for supply to HPFI.

Laminate casegood materials are Scientific Certification Systems (SCS) certified for FSC-STD-40-004 v2-0, FSC-STD-40-003 and FSC-STD-40-005 v2-1 standards as well as Composite Panel Association (EPP) certified for CPA 2-06 and CPA 3-08 standards. The cores of our casegood products come from suppliers that meet Sustainable Forestry Initiatives (SFI) standards and are over 80% recycled wood fibers.

Engineered wood components for upholstered seating products also meet SFI standards and meet CARB 2011 Standards -.08 ppm formaldehyde emission level. Seating foam is CFC-free and includes rapidly renewable bio-based materials.

Dust collection systems are in place to collect residual wood released during processing of raw wood materials into finished components for final assembly. The collected sawdust is reused for generating fuel, reducing waste as well as conserving another valuable resource, petroleum.

Proper finishing equipment is installed and maintained to appropriately collect any negative-impact materials. These are turned over to environmental professionals that specialize in safe and effective handling of such materials, further protecting our world.

We are committed to providing environmentally-conscious product solutions. HPFI actively markets Terratex-classified upholstery fabrics that are both 100% recycled (or bio-based) as well as completely recyclable (or compostable). These fabrics are manufactured from both post-consumer polyester (waste material left over once a consumer has used a product, such as a soda bottle) and post-industrial polyester (waste generated by an industrial process before the polyester is used by a consumer). In Life Cycle Assessments, Terratex-classified fabrics showed significantly lower environmental impact than fabrics made with virgin polyester across all twelve of the categories studied.

All corrugated cardboard material and containers used in the packaging and transport of our furniture products are made with a minimum of 41% recycled material (post-consumer and/or post-industrial) and meets standard performance requirements.

All of our associates are involved in environmentally-friendly practices. We utilize a 4-day work week, thereby reducing fuel consumption in both operations and commuting. Our sales brochures are printed on FSC-certified paper. Multiple collection bins are placed throughout our facilities for recycling to divert all production materials from landfills and recycled. Office paper, bottles, cans, etc. are also collected in our offices for recycling.

At HPFI, we understand the future does not belong to us, nor does the earth, nor its resources. The maintenance of our environment and a commitment to sustainability is an ongoing responsibility that we share with every person, organization and industry enjoying the abundance of this earth. We pledge to continually respect our resources and build community for those of us here today and for those who will follow.

Our sustainability efforts extend beyond the materials and processes involved in the manufacture and fabrication of our products. We also address end-of-life opportunities for our furniture. Additionally, our efforts involve social responsibility with HPFI associates as well as our business partners.

For additional information and the most up to date details, visit [www.hpfirmkt.com/Green.html](http://www.hpfirmkt.com/Green.html) or use your smart phone to scan the QR code below.



# COLLECTIONS

## BY MODEL NUMBER

model	page #	model	page #	model	page #	model	page #
74A	341	407C	281	810	220	1001	287
74B	341	407R	281	815	220	1003	287, 406
74C	341	500	279	821	226	1004	287, 406
99B	405	50050AT	279	822	226	1007	288
101	282	580	229	823	227	1071	288
101_	282	580CB	229	826	227	1077	288
121	283	581	230	826-2	227	1091	289
121_	283	581CB	230	830	217	1093	289
141	284	582	230	831	218	1094	289
141_	284	590	280	832	218	1097	289
143	284, 340	59050AT	280	833	218	1111	290
144	285, 340	621	270	834	219	1113	290, 407
151	338	627	270	835	219	1114	290, 407
152	338	631	271	836	219	1117	290
153	338	637	271	837	220	1211	291
154	339	683	308	840	221	1217	291
155	339	683C	309	841	221	1221	292
156	339	683U	308	843	221	1227	292
157	339	683UC	309	844	222	1231	292
158	339	693	308	845	222	1237	293
151MET	341	693C	310	847	222	1241	293
152MET	341	693U	309	850	311	1247	293
153MET	341	693UC	310	851	312	1271	297
154MET	342	694	309	860	311	1274	297
155MET	342	694C	310	861	312	1277	297
156MET	342	695	309	870	311	1621	294
161	285	695C	310	871	313	1624	294
161_	285	712	319	880	312	1627	295
163	285	713	319	881	313	1641	295
164	286	714	319	8_ _22	402	1647	295
181	269	715-CART	320	8_ _25	402	1661	296
186	269	720-CART	199	8_ _33	402	1667	296
191	283	720-GC	199	8_ _35	403	1727	195
191_	284	723	197	8_ _44	403	1727D	195
192_	286	723BC	198	8_ _45	403	1737	196
213	190	723SBC	198	8_0-30	312	1737D	196
213U	192	723SC	197	8_0-60	299, 312	1831	298
216	190	724	197	902	322	1834	298
216U	193	724BC	198	903	322	1837	298
217	191	724SBC	198	904	321	1900_	200
217U	193	724SC	198	904-2	410	2013	336
222	191	733	265	904-3	410	2016	336
222U	193	734	265	904-4	410	2177	336
223	191	741	262	905	322	2277	337
223U	193	741CB	262	906	321	3201	299
226	191	743	263	908	321	3207	299
226U	194	747	262	910	322	3271	298
228	192	747CB	263	912	224	3274	299
228U	194	748	263	912MET	326	3277	299
229	192	748CB	263	913	324	3473	337
229U	194	751	266	913MET	326	3477	337
233	192	751G	266	914	323	3901	300
233U	194	751GHR	266	914-2	411	3904	300
320BM	278	752	266	914-3	411	3907	301
320BM30T	278	752G	267	914-4	411	3921	301
320BM30AT	277	757	268	914MET	325	3927	301
320SM	277	757B	268	914MET-2	412	4013	327
320SM30T	277	759	267	914MET-3	412	4016	327
320SM30AT	276	759G	267	914MET-4	412	4017	327
321BM	276	761	264	915	324	4053	328, 390
321BM30T	276	763	264	915MET	326	4054	328, 390
321BM30AT	275	767	264	916	323	4057	328
321SM	275	781	260	916MET	325	4072	329, 391
321SM30T	275	781CB	260	917	412	4073	330, 391
321SM30AT	274	783	262	918	323	4074	330, 391
330FM30AL	273	787	261	918MET	325	4075	328, 391
330YM30AL	273	787CB	261	919	412	4076	329
331FM30AL	272	788	261	920	324	4077	330
331YM30AL	273	788CB	261	935	320	4078	330
407	281	790	397	992	320, 404	4083	329, 392
407B	281	793	397	993	320, 404	4121	332

model	page #	model	page #	model	page #	model	page #
4122	332	5914MET	357	7432	361	9430	303
4123	332	5920_	395	7432BLK	363	9433	306
4127	333	5920MET	394	7433	361	9434	306
4141	333	5923_	395	7433BLK	364	9435	306
4147	333	5923MET	394	7434	361	94CTC	303, 307
4161	334	5924_	351	7434BLK	364	9500	303
4167	334	5924MET	355	7435	362	9503	306
4178	331	5925_	351	7435BLK	364	9504	306
4277	331	5925MET	356	7436	362	9505	306
4301	393	5927_	395	7436BLK	364	9510	303
4302	393	5927MET	395	7441	363	9513	307
4303	393	5935-IF	350	7441BLK	365	9514	307
4831	335	5935-OF	350	7442	363	9515	307
4833	335	5935MET-IF	355	7442BLK	365	9601	378
4837	335	5935MET-OF	355	7443	363	9602	378
5201	367	5965-IF	350	7443BLK	366	9603	378
5202	367	5965-OF	350	7501	386	9621	376
5203	367	5965MET-IF	355	7502	386	9622	376
5221	368	5965MET-OF	355	7503	386	9623	376
5222	368	6101	371	7520	387	9641	377
5223	368	6102	371	7523	387	9642	377
5301	369	6103	371	7901	388	9643	377
5302	369	6201	372	7902	388	9923	404
5303	369	6202	372	7903	388	9924	405
5720_	396	6203	372	7920	389	9926	405
5720MET	395	6301	373	7923	389	ACE	379
5723_	396	6302	373	7948	389	ACW	378
5723MET	395	6303	373	7972	389	BB	223
5727_	396	6400	375	8233	227	C	225
5727MET	396	6401	374	8233D	228	CH	196
5801	343	6402	374	8233UD	228	DH	196
5802	343	6403	374	8501	314	DPS	223
5803	343	6701	380	8502	314	FH	225
5804	344	6702	380	8503	315	FT	223
5805	344	6703	380	8504	317	HC	225
5806	344	6720	375, 381, 397	8601	315	HM	224
5823_	346	6723	375, 381, 397	8602	315	HW_CT20	398
5827	347	6730	381, 397	8603	315	HW_CT48	398
5827UA	347	6733	381, 397	8604	317	HW_ET18	398
5830	344	7201	384	8701	315	HW_ET23	398
5831	344	7202	384	8702	316	HR751	267
5832	345	7203	384	8703	316	HR751G	268
5833	345	7220	385	8704	318	LPT	223
5835-IF	345	7223	385	8801	316	MA	347
5835-OF	345	7248	385	8802	316	MAL/MAR	348
5836_	346	7272	385	8803	316	MB	224
5843	346	7301	358	8804	318	MT	224
5844	346	7302	358	9103	409	MTB	224
5853	346	7303	358	9118	320, 408	NH	196
5860	344	7331	362	9120	383, 398	OX	225
5865-IF	345	7331BLK	365	9123	383, 398	PA	224
5865-OF	345	7335	362	9124	409	PB	223
58B	348	7335BLK	365	9126	409	PL	223
5901	349	7339L	362, 364	9128	320, 408	RA	225
5901MET	354	7339R	362, 365	9131	382	S_CT20	396
5902	349	7401	359	9132	382	T1005	280, 406
5902MET	354	7402	359	9133	382	TAL/TAR	348
5903	350	7403	359	9138	383	TR_4020	329, 401
5903MET	354	7420	359, 399	9193CTC	409	TR_4023	329, 401
5904	351	7420BLK	366, 400	9400	302	UA	347
5904MET	356	7421	359, 399	9403	304	UAL/UAR	347
5905	351	7423	359, 399	9404	304	UP9600BC	379
5905MET	356	7423BLK	366, 400	9405	304	UP9600SC	379
5906	351	7424	360, 399	9410	302	WA	224
5906MET	356	7424BLK	366, 400	9413	305		
5911	352, 356	7425	360, 399	9414	305		
5912	352	7425BLK	366, 400	9415	305		
5912MET	357	7426	360, 399	9420	302		
5913	352	7426BLK	366, 400	9423	305		
5913MET	357	7431	361	9424	305		
5914	353	7431BLK	363	9425	305		



High Point Furniture Industries  
PO Box 2063  
High Point, NC 27261  
USA

p 336.431.7101  
t 800.447.3462  
f 336.434.1964

[hpfi.com](http://hpfi.com)

