



Belmont

VENEER COLLECTION

7130 Executive Cherry Finish / 7132 Brown Cherry Finish

Unpretentious yet smartly styled.

The Belmont Collection's transitional style brings refined warmth to any office, with solid construction to last through the years. New-world looks complement old-world touches like felt-lined box and center drawers, bow-front work surfaces and double beaded crown moldings, along with inlaid cherry veneer tops bordered by a rich walnut banding.

Details:

- Constructed of hardwoods, wood materials and cherry veneers with walnut veneer inlays on mortise and tenon construction with wood cleats, glue, staples and screws
- 7130 tops feature engineered cherry veneers and 7132 tops top feature cherry veneers, both tops are bordered by walnut banding and feathered cherry veneers
- Tops have a protective UV finish resistant to stains, mars and scratches
- Center drawers are felt-lined with a wood pencil tray
- Locking pedestals via knee space located locks
- All drawers suspended on fully extending, metal ball-bearing slides
- File drawers rated for 150 lbs; box drawers rated for 75 lbs;
- 4-sided plywood constructed drawers with dovetail joints; sealed and stained drawer interiors
- File drawers equipped with metal rods for letter or legal sized hanging files
- Adjustable floor levelers
- Cable accessible



FLEXSTEEL®
CONTRACT

DMI COLLECTION



Belmont VENEER COLLECTION



FLEXSTEEL®
CONTRACT

7130 Executive Cherry Finish / 7132 Brown Cherry Finish

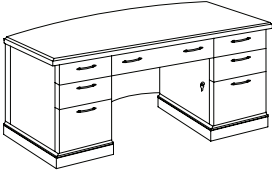

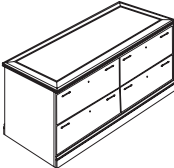
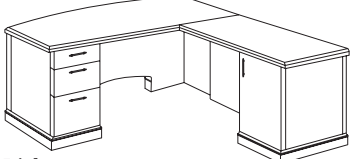
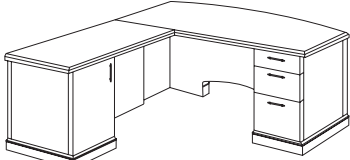
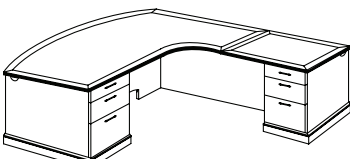
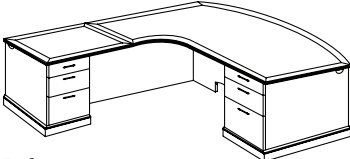
DMI COLLECTION

	Item Description Model Number	W"	D"	H"	Weight Lbs.	Cubic Ft.	List Price	Features
	Executive Bow Front Desk 713_-36	72	36	30	335	59.3	\$ 3097.00	<ul style="list-style-type: none"> • Box / box / file drawer per pedestal • Felt-lined center drawer with wood pencil tray • Radius shaped top
	Credenza 713_-21	72	24	30	310	41.4	\$ 2517.00	<ul style="list-style-type: none"> • Felt-lined box with wood pencil tray / box / file drawer per pedestal • Designed for use in wall unit applications
	Credenza with Full Return Base Mouldings 713_-23	71.75	24	30	305	41.4	\$ 2517.00	<ul style="list-style-type: none"> • Felt-lined box with wood pencil tray / box / file drawer per pedestal • Full return, base moulding
	Lateral File Credenza 713_-277	72	24	30	335	41.4	\$ 3053.00	<ul style="list-style-type: none"> • Four independently locking lateral file drawers
	Right Computer L Desk 713_-27 Consists of: -570 Left Single Pedestal Desk -379 Rt Sgl Computer Ped Return	72	84	30	463	86.6	\$ 4645.00	<ul style="list-style-type: none"> • Felt-lined box / box / file drawer in desk pedestal • Ventilated computer storage cabinet with two media drawers and power manager in return pedestal
Right								
	Left Computer L Desk 713_-28 Consists of: -580 Right Single Pedestal Desk -389 Lt Sgl Computer Ped Return	72	84	30	463	86.6	\$ 4645.00	
Left								
	Right Corner L Desk 713_-50 Consists of: -770 Left Corner Single Ped Desk -279 Right Single Pedestal Return	72	86.5	30	550	91.1	\$ 6525.00	<ul style="list-style-type: none"> • Felt-lined box / box / file drawer per pedestal
Right								
	Left Corner L Desk 713_-51 Consists of: -780 Right Corner Single Ped Desk -289 Left Single Pedestal Return	72	86.5	30	550	91.1	\$ 6525.00	
Left								

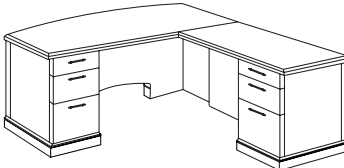
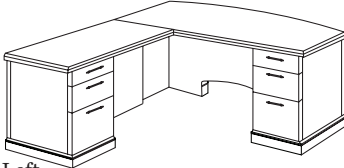
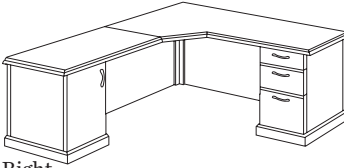
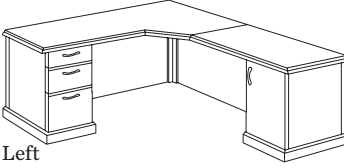
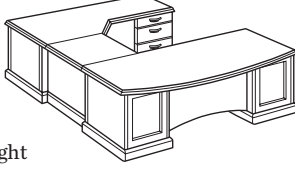
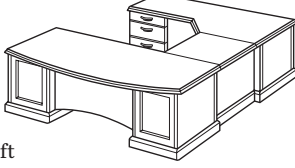
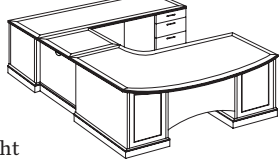

DMI COLLECTION

7130 Executive Cherry Finish / 7132 Brown Cherry Finish

	Item Description	W"	D"	H"	Weight	Cubic	List	Features
	Model Number				Lbs.	Ft.	Price	
	Right Executive L Desk	72	84	30	477	87.1	\$ 4645.00	• Felt-lined box / box / file drawer per pedestal
	713_-57							
	Consists of:							
	-570 Left Single Pedestal Desk	72	36	30	287	59.3	\$ 2903.00	
	-579 Right Single Pedestal Return	48	24	30	190	27.8	\$ 1742.00	
	Left Executive L Desk	72	84	30	477	87.1	\$ 4645.00	
	713_-58							
	Consists of:							
	-580 Right Single Pedestal Desk	72	36	30	287	59.3	\$ 2903.00	
	-589 Left Single Pedestal Return	48	24	30	190	27.8	\$ 1742.00	
	Right CPU Corner Unit	72	84	30	444	86.6	\$ 4841.00	• Ventilated computer storage cabinet with 2 media drawers and power manager in return pedestal • Felt-lined box / box / file drawer in credenza pedestal
	713_-76							
	Consists of:							
	-389 Lt Sgl Computer Ped Return	48	24	30	176	27.3	\$ 1742.00	
	-517 Rt Sgl Ped Corner Credenza	72	36	30	268	59.3	\$ 3099.00	
	Left CPU Corner Unit	72	84	30	444	86.6	\$ 4841.00	
	713_-77							
	Consists of:							
	-379 Rt Sgl Computer Ped Return	48	24	30	176	27.3	\$ 1742.00	
	-518 Left Sgl Ped Corner Credenza	72	36	30	268	59.3	\$ 3099.00	
	Right Executive Corner U Desk	72	110	30	620	123.1	\$ 6583.00	• Felt-lined box / box / file drawer per pedestal
	713_-78							
	Consists of:							
	-570 Left Single Pedestal Desk	72	36	30	287	59.3	\$ 2903.00	
	-517 Rt Sgl Ped Corner Credenza	72	36	30	268	59.3	\$ 3099.00	
	-69 Bridge	38	24	30	65	4.5	\$ 581.00	
	Left Executive Corner U Desk	72	110	30	620	123.1	\$ 6583.00	
	713_-79							
	Consists of:							
	-580 Right Single Pedestal Desk	72	36	30	287	59.3	\$ 2903.00	
	-518 Left Sgl Ped Corner Credenza	72	36	30	268	59.3	\$ 3099.00	
	-69 Bridge	38	24	30	65	4.5	\$ 581.00	
	Right Executive U with Corner Desk	72	110	30	640	112.4	\$ 8250.00	• Felt-lined box / box / file drawer per pedestal
	713_-847							
	Consists of:							
	-770 Left Corner Single Ped Desk	72	48	30	300	70.8	\$ 4677.00	
	-571 Rt Single Pedestal Credenza	72	24	30	275	37.1	\$ 2992.00	
	-69 Bridge	38	24	30	65	4.5	\$ 581.00	
	Left Executive U with Corner Desk	72	110	30	640	112.4	\$ 8250.00	
	713_-848							
	Consists of:							
	-780 Right Corner Single Ped Desk	72	48	30	300	70.8	\$ 4677.00	
	-581 Left Single Pedestal Credenza	72	24	30	275	37.1	\$ 2992.00	
	-69 Bridge	38	24	30	65	4.5	\$ 581.00	





Belmont VENEER COLLECTION

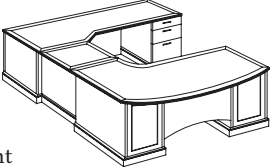
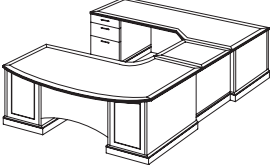
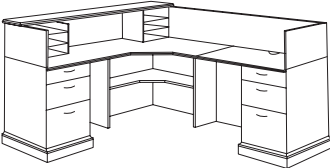
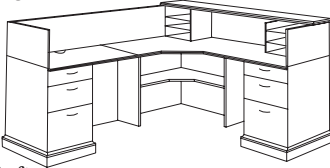
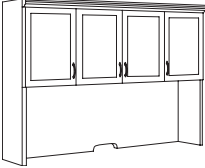

FLEXSTEEL®
CONTRACT

7130 Executive Cherry Finish / 7132 Brown Cherry Finish

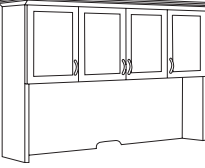





DMI COLLECTION

	Item Description	W"	D"	H"	Weight Lbs.	Cubic Ft.	List Price	Features
	Right Executive Workstation U Desk 713_-845 Consists of: -770 Left Corner Single Ped Desk -517 Rt Sgl Ped Corner Credenza -69 Bridge	72	120	30	618	135.3	\$ 8357.00	• Felt-lined box / box / file drawer per pedestal
Right								
	Left Executive Workstation U Desk 713_-846 Consists of: -780 Right Corner Single Ped Desk -518 Left Sgl Ped Corner Credenza -69 Bridge	72	120	30	618	135.3	\$ 8357.00	
Left								
	Right Reception L Desk 713_-66 Consists of: -680 Left Single Pedestal Desk -179 Right Single Pedestal Return -523 Risers	73.5	88.5	43	630	129.4	\$ 7461.00	• Box / box with dividers / file drawer per pedestal • Two letter organizers
Right								
	Left Reception L Desk 713_-67 Consists of: -690 Right Single Pedestal Desk -189 Left Single Pedestal Return -524 Risers	73.5	88.5	43	630	129.4	\$ 7461.00	
Left								
	Overhead Storage 713_-62	72	15	50	267	44.4	\$ 2517.00	• Three cabinets each with an adjustable shelf • 18" task light • 23.75" vertical clearance for monitor • For use with -21, -277
								
	Overhead Storage with Organizers 713_-625 Consists of: -62 Overhead Storage -621 Letter Tray/Drawer Organizer -622 Letter Tray Organizer	72	15	50	340	51.8	\$ 3593.00	• Three cabinets each with an adjustable shelf • One organizer with two drawers and three letter trays; one organizer with seven letter trays • 18" task light • 23.75" vertical clearance for monitor • For use with -21, -277
								
	Overhead Storage with Full Return Moulding 713_-63 713_-64	74.5	15	50	250	44.4	\$ 2517.00	• Three cabinets each with an adjustable shelf • 18" task light • 23.75" vertical clearance for monitor • -63 for use with -21, -277 • -64 for use with -23, -517, -518, -571, -581, -770, -780
								
	Overhead Storage with Full Return Moulding and Organizers 713_-635 Consists of: -63 Overhead Storage -621 Letter Tray/Drawer Organizer -622 Letter Tray Organizer	74.5	15	50	323	51.8	\$ 3593.00	• Three cabinets each with an adjustable shelf • One organizer with two drawers and three letter trays; one organizer with seven letter trays • 18" task light • 23.75" vertical clearance for monitor • For use with -21, -277
								
	Lateral File 713_-16	36	24	30	176	21.2	\$ 1549.00	• Two locking file drawers • Full return base mouldings • Anti-tip device
								

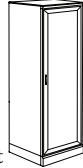

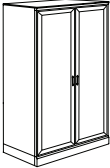
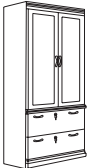
DMI COLLECTION

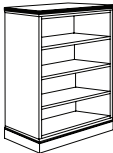
7130 Executive Cherry Finish / 7132 Brown Cherry Finish

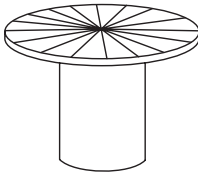
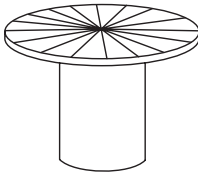
Item Description		W"	D"	H"	Weight	Cubic	List	Features
Model Number				Lbs.	Ft.	Price		
 Right  Left	Right Hand Facing Single Door Wardrobe 713_-05	18	24	78	200	25.3	\$ 2100.00	<ul style="list-style-type: none"> • Hanger rod • Five adjustable shelves • When creating a wall configuration with Belmont credenza and overhead, use the -63 or -635 overheads • -05 is hinged on right • -05LH is hinged on left
	Left Hand Facing Single Door Wardrobe 713_-05LH	18	24	78	200	25.3	\$ 2100.00	
	Double Door Wardrobe 713_-06	36	24	78	250	51.1	\$ 3892.00	<ul style="list-style-type: none"> • Hanger rod • Ten adjustable shelves • When creating a wall configuration with Belmont credenza and overhead, use the -63 or -635 overheads
	Lateral File Storage Unit 713_-07	36	24.5	80	332	54.1	\$ 3292.00	<ul style="list-style-type: none"> • Two lateral file drawers • Two-door cabinet with two adjustable shelves • When creating a wall configuration with Belmont credenza and overhead, use the -62 or -625 overheads
	Bookcase 713_-09	36	15	80	204	35.3	\$ 2063.00	<ul style="list-style-type: none"> • Two adjustable shelves • Two-door cabinet with an adjustable shelf • When creating a wall configuration with Belmont credenza and overhead, use the -62 or -625 overheads
	48" Bookcase 713_-048	36	15	48	100	19.7	\$ 1508.00	<ul style="list-style-type: none"> • Two adjustable shelves
	60" Bookcase 713_-060	36	15	60	150	24.4	\$ 1863.00	<ul style="list-style-type: none"> • Three adjustable shelves
	72" Bookcase 713_-072	36	15	72	175	28.3	\$ 2110.00	<ul style="list-style-type: none"> • Three adjustable shelves • One fixed shelf
	42" Round Conference Table 713_-89	42	42	30	125	12.6	\$ 1897.00	
	Consists of:							
	-011 Top	42	42		40	4.4	\$ 1206.00	
	-005 Cylinder Base	20	20		85	8.2	\$ 691.00	
	48" Round Conference Table 713_-90	48	48	30	135	13.8	\$ 2415.00	
	Consists of:							
	-016 Top	48	48		50	5.6	\$ 1724.00	
	-005 Cylinder Base	20	20		85	8.2	\$ 691.00	







Belmont VENEER COLLECTION

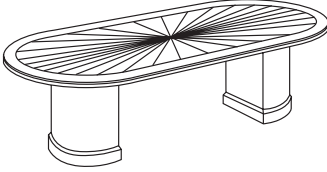
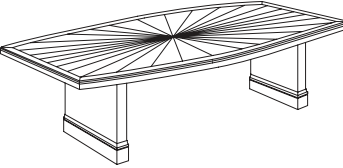
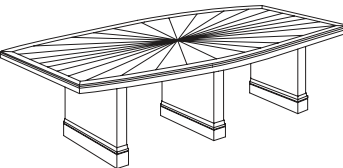
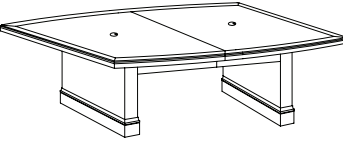

FLEXSTEEL®
CONTRACT

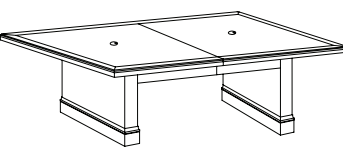
7130 Executive Cherry Finish / 7132 Brown Cherry Finish

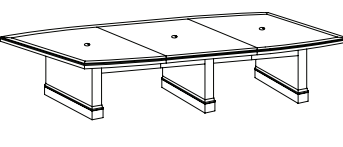
DMI COLLECTION

Item Description	W"	D"	H"	Weight Lbs.	Cubic Ft.	List Price	Features
 8' Race Track Conference Table 713_-96 Consists of: -961 Top -962 Bases (set)	96	48	30	276	26.3	\$ 4137.00	
 10' Boat Shaped Conference Table 713_-97 Consists of: -971 Top (2 piece) -972 Slab End Bases (set)	120	48	30	326	27.0	\$ 4307.00	• Table top comes in two pieces for ease in installation
 12' Boat Shaped Conference Table 713_-98 Consists of: -981 Top (2 piece) -982 Slab End Bases (3 piece set)	144	48	30	415	31.5	\$ 5242.00	• Table top comes in two pieces for ease in installation
 8' Boat Shaped Expandable Conference Table 713_-96EX Consists of: -9031 Left & Right Tops -9033 Bases (2 needed) -9034 Rail Set	96	48	30	300	25.4	\$ 3104.00	• Grommet in each top section • Optional storage base, -113, available
 10' Boat Shaped Expandable Conference Table 713_-120EX Consists of: -9030 Left & Right Tops -9033 Bases (2 needed) -9038 Rail Set	120	48	30	330	31.9	\$ 3974.00	
 8' Rectangular Expandable Conference Table 713_-96REX Consists of: -9028 Left & Right Tops -9033 Bases (2 needed) -9034 Rail Set	96	48	30	300	25.4	\$ 3014.00	• Grommet in each top section • Optional storage base, -113, available
 10' Rectangular Expandable Conference Table 713_-120REX Consists of: -9029 Left & Right Tops -9033 Bases (2 needed) -9038 Rail Set	120	48	30	330	31.9	\$ 3760.00	
 12' Boat Shaped Expandable Conference Table 713_-144EX Consists of: -9031 Left & Right Tops -9032 Center Top & Rails -9033 Bases (3 needed) -9035 Rail Set (2 needed)	144	48	30	475	41.6	\$ 4944.00	• Grommet in each top section • Optional storage base, -113, available
 14' Boat Shaped Expandable Conference Table 713_-168EX Consists of: -9030 Left & Right Tops -9032 Center Top & Rails -9033 Bases (3 needed) -9037 Rail Set (2 needed)	168	48	30	505	48.2	\$ 5815.00	



DMI COLLECTION

7130 Executive Cherry Finish / 7132 Brown Cherry Finish

Item Description	W"	D"	H"	Weight Lbs.	Cubic Ft.	List Price	Features
12' Rectangular Expandable Conference Table 713_-144REX	144	48	30	475	41.6	\$ 4854.00	<ul style="list-style-type: none"> • Grommet in each top section • Optional storage base, -113, available
Consists of:							
-9028 Left & Right Tops	48	48		150	11.4	\$ 1883.00	
-9032 Center Top & Rails	48	48		75	8.6	\$ 1217.00	
-9033 Bases (3 needed)	28	5.25	29	150	18.6	\$ 1440.00	
-9035 Rail Set (2 needed)	48			100	3.0	\$ 314.00	
14' Rectangular Expandable Conference Table 713_-168REX	168	48	30	505	48.2	\$ 5601.00	
Consists of:							
-9029 Left & Right Tops	60	48		180	17.2	\$ 2606.00	
-9032 Center Top & Rails	48	48		75	8.6	\$ 1217.00	
-9033 Bases (3 needed)	28	5.25	29	150	18.6	\$ 1440.00	
-9037 Rail Set (2 needed)	60.5			100	3.8	\$ 338.00	
16' Boat Shaped Expandable Conference Table 713_-192EX	192	48	30	600	56.4	\$ 6641.00	<ul style="list-style-type: none"> • Grommet in each top section • Optional storage base, -113, available
Consists of:							
-9031 Left & Right Tops	48	48		150	11.4	\$ 1973.00	
-9032 Center Top & Rails (2 needed)	48	48		150	17.2	\$ 2434.00	
-9033 Bases (4 needed)	28	5.25	29	200	24.8	\$ 1920.00	
-9035 Rail Set (2 needed)	48			100	3.0	\$ 314.00	
18' Boat Shaped Expandable Conference Table 713_-216EX	216	48	30	630	63.0	\$ 7512.00	
Consists of:							
-9030 Left & Right Tops	60	48		180	17.2	\$ 2820.00	
-9032 Center Top & Rails (2 needed)	48	48		150	17.2	\$ 2434.00	
-9033 Bases (4 needed)	28	5.25	29	200	24.8	\$ 1920.00	
-9037 Rail Set (2 needed)	60.5			100	3.8	\$ 338.00	
16' Rectangular Expandable Conference Table 713_-192REX	192	48	30	600	56.4	\$ 6551.00	<ul style="list-style-type: none"> • Grommet in each top section • Optional storage base, -113, available
Consists of:							
-9028 Left & Right Tops	48	48		150	11.4	\$ 1883.00	
-9032 Center Top & Rails (2 needed)	48	48		150	17.2	\$ 2434.00	
-9033 Bases (4 needed)	28	5.25	29	200	24.8	\$ 1920.00	
-9035 Rail Set (2 needed)	48			100	3.0	\$ 314.00	
18' Rectangular Expandable Conference Table 713_-216REX	216	48	30	630	63.0	\$ 7298.00	
Consists of:							
-9029 Left & Right Tops	60	48		180	17.2	\$ 2606.00	
-9032 Center Top & Rails (2 needed)	48	48		150	17.2	\$ 2434.00	
-9033 Bases (4 needed)	28	5.25	29	200	24.8	\$ 1920.00	
-9037 Rail Set (2 needed)	60.5			100	3.8	\$ 338.00	
20' Boat Shaped Expandable Conference Table 713_-240EX	240	48	30	725	71.2	\$ 8338.00	<ul style="list-style-type: none"> • Grommet in each top section • Optional storage base, -113, available
Consists of:							
-9031 Left & Right Tops	48	48		150	11.4	\$ 1973.00	
-9032 Center Top & Rails (3 needed)	48	48		225	25.8	\$ 3651.00	
-9033 Bases (5 needed)	28	5.25	29	250	31.0	\$ 2400.00	
-9035 Rail Set (2 needed)	48			100	3.0	\$ 314.00	
22' Boat Shaped Expandable Conference Table 713_-264EX	264	48	30	755	77.8	\$ 9209.00	
Consists of:							
-9030 Left & Right Tops	60	48		180	17.2	\$ 2820.00	
-9032 Center Top & Rails (3 needed)	48	48		225	25.8	\$ 3651.00	
-9033 Bases (5 needed)	28	5.25	29	250	31.0	\$ 2400.00	
-9037 Rail Set (2 needed)	60.5			100	3.8	\$ 338.00	





Belmont VENEER COLLECTION

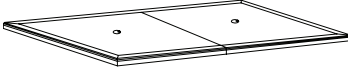

FLEXSTEEL®
CONTRACT

7130 Executive Cherry Finish / 7132 Brown Cherry Finish

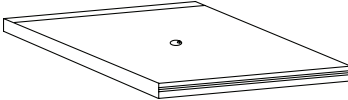
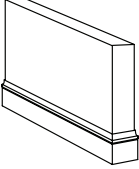
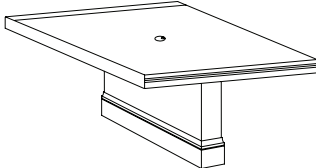
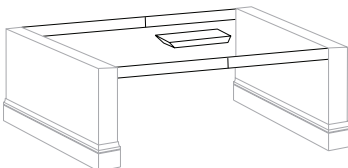



DMI COLLECTION

Item Description	W"	D"	H"	Weight Lbs.	Cubic Ft.	List Price	Features
20' Rectangular Expandable Conference Table 713_-240REX Consists of: -9028 Left & Right Tops -9032 Center Top & Rails (3 needed) -9033 Bases (5 needed) -9035 Rail Set (2 needed)	240	48	30	725	71.2	\$ 8248.00	<ul style="list-style-type: none"> Grommet in each top section Optional storage base, -113, available
							
22' Rectangular Expandable Conference Table 713_-264REX Consists of: -9029 Left & Right Tops -9032 Center Top & Rails (3 needed) -9033 Bases (5 needed) -9037 Rail Set (2 needed)	264	48	30	755	77.8	\$ 8995.00	
48" Left & Right Section Rectangular Expandable Conference Table Top 713_-9028	96	48		150	11.4	\$ 1883.00	<ul style="list-style-type: none"> Two piece tops Grommet in each top section
							
60" Left & Right Section Rectangular Expandable Conference Table Top 713_-9029	120	48		180	17.2	\$ 2606.00	
48" Left & Right Section Boat Shaped Expandable Conference Table Top 713_-9031	96	48		150	11.4	\$ 1973.00	<ul style="list-style-type: none"> Two piece tops Grommet in each top section
							
60" Left & Right Section Boat Shaped Expandable Conference Table Top 713_-9030	120	48		180	17.2	\$ 2820.00	
48" Center Section Expandable Conference Table Top with 44" Rails 713_-9032	48	48		75	8.6	\$ 1217.00	<ul style="list-style-type: none"> Rails include wire management tray for top Grommet in top
							
Expandable Conference Table Base 713_-9033	29.5	5.5	29	50	6.2	\$ 480.00	<ul style="list-style-type: none"> -113 must be placed at the end of the table
							
Expandable Conference Table Storage Base 713_-113	29.5	5.5	29	48	6.3	\$ 529.00	
48" Center Section Top and Base 713_-903233 Consists of: -9032 Center Top & Rails -9033 Base	48	48	30	125	14.8	\$ 1697.00	<ul style="list-style-type: none"> Grommet in top
							
Expandable Conference Table Rail Sets 713_-9034 713_-9035 713_-9037 713_-9038	52 48 60.5 76	.75 .75 .75 .75	4 4 4 4	50 50 50 50	1.6 1.5 1.9 2.3	\$ 171.00 \$ 157.00 \$ 169.00 \$ 194.00	<ul style="list-style-type: none"> Includes wire management tray for top -9034 rail set for -96EX, -96REX -9035 rail set for -9028, -9031 -9037 rail set for -9029, -9030 -9038 rail set for -120EX, -120REX
							
Buffet 713_-25B	66	24	36	200	41.0	\$ 3362.00	<ul style="list-style-type: none"> Two felt-lined, fully extending drawers with one drawer having a silverware holder Two cabinets each with an adjustable shelf Four, heavy duty casters
							

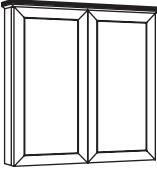
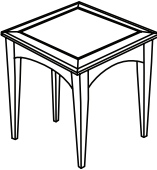
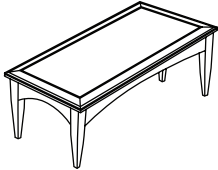

DMI COLLECTION

7130 Executive Cherry Finish / 7132 Brown Cherry Finish

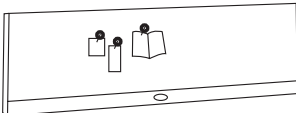
	Item Description Model Number	W"	D"	H"	Weight Lbs.	Cubic Ft.	List Price	Features
	Two Door Buffet 713_-26B	38	24	36	175	27.0	\$ 2790.00	<ul style="list-style-type: none"> Felt-lined, fully extending drawer One cabinet with an adjustable shelf Four, heavy duty casters
	Presentation Board 713_-650	48	3.75	49	106	9.4	\$ 1629.00	<ul style="list-style-type: none"> Open: 96" x 3.75" x 49" Features marker board and tack boards on the interior of each door
	End Table 713_-10	24	24	24	30	4.9	\$ 707.00	<ul style="list-style-type: none"> Construction of veneer on MDF with wood legs
	Coffee Table 713_-40	48	24	18	40	6.4	\$ 920.00	<ul style="list-style-type: none"> Construction of veneer on MDF with wood legs
	Sofa/Console Table 713_-84	48	16	28	53	5.0	\$ 886.00	<ul style="list-style-type: none"> Construction of veneer on MDF with wood legs
	Executive Leather High Back Chair 713_-80	26.5	28.5	45-48	71	17.4	\$ 1285.00	<ul style="list-style-type: none"> Upholstered in black leather Five star base Knee tilt mechanism 18" seat depth Seat height adjusts from 20"-23"
	Executive Leather Med Back Chair 713_-81	26.5	28.5	38.5-42.5	63	12.5	\$ 1168.00	<ul style="list-style-type: none"> Upholstered in black leather Five star base Knee tilt mechanism 18" seat depth Seat height adjusts from 20"-23"
	Black Cloth Tack Board 0000-341	69.75	23.5		12	2.0	\$ 344.00	<ul style="list-style-type: none"> For use on -62, -63 & -64

